

Arup

MassMotion

The Verification and Validation of
MassMotion for Evacuation
Modelling

072377-00_R-001

Issue 01 | 10 August 2015

This report takes into account the particular instructions and requirements of our client.

It is not intended for and should not be relied upon by any third party and no responsibility is undertaken to any third party.

Job number 072377-00

Ove Arup & Partners Ltd
13 Fitzroy Street
London
W1T 4BQ
United Kingdom
www.arup.com

ARUP

Document Verification

ARUP

Job title		MassMotion		Job number	
				072377-00	
Document title		The Verification and Validation of MassMotion for Evacuation Modelling		File reference	
Document ref		072377-00_R-001			
Revision	Date	Filename	2015-04-01_MassMotion_Evacuation_V&V_Draft-01.docx		
Draft 01	01-Apr-2015	Description	First Draft		
			Prepared by	Checked by	Approved by
		Name	Michael Kinsey	-	-
		Signature			
Draft 02	31-May-2015	Filename	2015-05-31_MassMotion_Evacuation_V&V_Draft-02.docx		
		Description	Second Draft		
			Prepared by	Checked by	Approved by
		Name	Michael Kinsey	Gary Walker / Nick Swailes	-
		Signature			
Draft 03	22-Jun-2015	Filename	2015-06-22_MassMotion_Evacuation_V&V_Draft-03.docx		
		Description	Third Draft		
			Prepared by	Checked by	Approved by
		Name	Michael Kinsey	Gary Walker / Nick Swailes	Neal Butterworth
		Signature			
Issue 01	10-Aug-2015	Filename	2015-08-10_MassMotion_Evacuation_V&V_Issue-01.docx		
		Description	First Issue		
			Prepared by	Checked by	Approved by
		Name	Michael Kinsey	Gary Walker / Nick Swailes	Neal Butterworth
		Signature			

Issue Document Verification with Document



Contents

	Page
Executive Summary	2
1 Introduction	4
1.1 Context	4
1.2 Purpose and Scope	5
1.3 Structure	5
2 MassMotion	7
2.1 Introduction	7
2.2 History	7
2.3 Geometrical Components	7
2.4 Agents	8
2.5 Agent Attributes	8
2.6 Agent Route Selection	8
2.7 Agent Movement	9
2.8 Comparison with Other Software Specifications	9
3 Theoretical Model Specification	10
3.1 Context	10
3.2 Agent Motion	10
3.3 Agent Events	11
3.4 Agent Attributes	12
3.5 Agent Route Selection	14
3.6 Agent Movement	15
3.7 Social Forces	16
4 MassMotion Verification	19
5 MassMotion Validation	22
6 Discussion	24
6.1 Summary	24
6.2 Verification Testing	24
6.3 Validation Testing	24
6.4 Uncertainty	24
6.5 Conclusion	25
7 References	27

Executive Summary

MassMotion [1] is a pedestrian dynamics and evacuation simulation software tool developed by Oasys (Ove Arup SYStems). This report documents the verification and validation of MassMotion for evacuation modelling.

MassMotion replicates the built environment as a series of geometrical components (e.g. floors, ramps, stairs, escalators, doors, barriers and portals). Agents (or occupants of the 3-dimensional space) are

- introduced into the geometry of the built environment via entry portals;
- interact with the geometry components, and other agents; and
- depart from the geometry via exit portals,

in accordance with user specified evacuation scenarios.

The route selection of an evacuating agent can be specified in two ways:

- **Least Cost** – Agents travel via the ‘easiest’ route. Agents are aware of all / some exit portals (at the start of the simulation and as exit portals become available / unavailable). The effort, or ‘Cost’, associated with each route (to an exit portal of which they are aware) is calculated for the agent at each time step. The agent will take the ‘Least Cost’ path to an exit portal.
- **Specified Destination** – An exit portal is specified for each agent. The agent will take the ‘Least Cost’ route to the specific exit portal.

The movement of agents through the model is a reflexive process implemented via a ‘Social Forces’ algorithm [2][3][4]. At each time step, ‘forces’ act upon the agents causing them to move accordingly. The ‘Social Forces’ algorithm has been calibrated in accordance with Fruin’s Level of Service model [5][6] developed for pedestrian planning.

Verification Testing

Verification testing of the MassMotion model has been performed in accordance with:

- International Maritime Organisation (IMO) 1238 [7];
- National Institute of Standards (NIST) Technical Note 1822 [8].

Additionally, testing of aspects of the model not included within the IMO 1238 and NIST Technical Note 1822 verification tests has been conducted.

The full range of verification tests undertaken is illustrated in Table 6.

Sensitivity testing has been applied to some of the verification tests to demonstrate the sensitivity of the prediction to changes in input parameters.

All the verification tests investigated passed the stated acceptance criteria. It was noted that two verification tests demonstrated a high sensitivity of the prediction to small changes in the input parameter: these are marked ‘See Test’ (where additional information is provided). Changes to the highlighted input parameter should be considered carefully, as otherwise there is an increased potential for unrealistic predictions.

Results from the verification tests indicate that MassMotion is able to predict the expected results for those cases tested.

Validation Testing

Validation studies, comparing MassMotion predictions with ‘real world’ evacuation events, evacuation drills and circulation events, were presented.

Results from the validation case studies demonstrate that MassMotion predictions were comparable to the actual data. In those cases studied, therefore, it may be concluded that MassMotion is able to represent the key aspects of human behaviour during an evacuation.

Uncertainty

Total model verification and validation is not possible. (There are multiple sources of uncertainty associated with the numerical modelling process.)

Verification and validation provide a means to assess the suitability of a mathematical model (implemented as a numerical model in computer software) for its intended purpose of representing the physical behaviour by reducing the uncertainty wherever it is possible to do so.

In the context of MassMotion, and this verification and validation exercise specifically, the aim has been to:

- reduce the model (mathematical and model) and user (knowledge) uncertainties through the verification testing;
- reduce the model (conceptual), data and user (knowledge) uncertainties through the validation case studies.

Where the specific application utilises aspects of MassMotion outside the range verified and / or validated, then, the uncertainty must be reduced (by mitigating the use of the components / sub-models where uncertainty exists or mitigating the uncertainty itself).

The theories and data employed within MassMotion are those founded on observations derived from normal circulation behaviour where people are not exposed to a hazard or have a heightened level of perceived risk. For specific engineering applications where it is likely that evacuees will experience a heightened level of perceived risk, the modeller should determine:

- the extent to which the underlying theories and data remain valid;
- whether alteration of the default configurable parameters (e.g. decreasing pre-evacuation times, increasing travel speeds) might yield more probable predictions.

It is essential that the extent of the MassMotion verification and validation be considered, in the context of the specific application of interest, to assess the suitability of MassMotion for:

- representing the reality of an evacuation event in the environment of interest; and
- the extent to which any predictions from MassMotion supports the fire safety strategy.

This is particularly relevant when assessing the uncertainty in the core elements (Agent Route Selection, Agent Movement and Social Forces) of the MassMotion model.

Conclusions

Verification and validation (particularly) is an on-going process.

The verification and validation process provides confidence that MassMotion is capable of representing the key aspects of human behaviour in a variety of evacuation scenarios.

1 Introduction

1.1 Context

MassMotion is a pedestrian dynamics and evacuation simulation software tool developed by Oasys (Ove Arup SYStems).

MassMotion replicates the built environment as a series of geometrical components (e.g. floors, ramps, stairs, escalators, doors, barriers and portals). Agents (or occupants of the 3-dimensional space) are

- introduced into the geometry of the built environment via entry portals;
- interact with the geometry components, and agents; and
- depart from the geometry via exit portals,

in accordance with user specified evacuation scenarios.

MassMotion implements a theoretical (conceptual) model simulating human behaviour in an evacuation event. Verification and validation can be defined as the following:

- **Verification** testing demonstrates that the theoretical model has been implemented correctly within MassMotion.
- **Validation** testing demonstrates whether the theoretical model (and its implementation in MassMotion) provides an acceptable representation of ‘real life’ evacuation events.

Ideally, all components of a model would be completely verified and validated in every possible way and for every possible combination of use such that the model is a complete representation of reality given the boundaries of the specified system, i.e. **total model verification and validation**. Such a model would provide complete confidence that it was able to represent any ‘real life’ scenario of the given system. This is only possible when a complete understanding of all / most aspects of the underlying system is attained. Such models rarely exist (and, typically, not at all for complex systems of interest to the engineer) due to an incomplete understanding of many aspects of any system, i.e. **models are simplifications of reality**. This simplification introduces a level of uncertainty when representing ‘real life’ events. The extent of this uncertainty can vary between different components / sub-models of the model.

Model verification and validation should be considered as part of the process of mitigating the influence of uncertainty within a decision making process. The greater the quantity and quality of verification and validation, the greater the confidence in the model’s suitability to represent reality (and, subsequently, influence the decision making process associated with the work undertaken using the model). Where the verification and validation is less or of a lower quality, the model should not necessarily be thought of as being ‘not validated’: instead, the model user must identify and mitigate (or reduce) the uncertainty for the specific engineering application of interest. This can be achieved by:

- A. mitigating the use of given model components / sub-models where uncertainty exists; and / or

B. mitigating the uncertainty of given model components / sub-models where uncertainty exists.

The latter may be addressed by one (or more) of the following methods:

- increasing the understanding of the real world phenomena which the component represents to inform model usage / development (e.g. through research of the subject matter);
- conducting sensitivity analysis to understand the implication of the range of variance derived from using the component / sub-model;
- using conservatism in the setting / usage of the component to remove / mitigate the doubt associated with the potential impact of its usage (noting that this may increase the redundancy required for a given fire safety strategy).

It is essential that the extent of model verification and validation be considered in the context of the specific engineering application to determine the suitability of the model for

- representing the reality of an evacuation event, and
- the subsequent extent to which it informs decision making through specification of the fire safety strategy.

1.2 Purpose and Scope

This report documents the verification and validation of MassMotion for evacuation modelling. It has been developed by Arup Fire engineers in association with the Oasis MassMotion development team. It is intended to provide the reader with sufficient information to demonstrate that MassMotion is able to represent the key aspects of human behaviour during an evacuation event (to a level of accuracy which facilitates reasonable estimates of key predictive outputs typical of such models).

Verification and validation of MassMotion is a continual process, particularly as understanding of human behaviour in fire increases (and, thus, evacuation data / models are enhanced).

1.3 Structure

The report structure, described below, follows the verification and validation methodology adopted.

- Section 2 – **MassMotion.**

The scope / capability of MassMotion for undertaking evacuation simulations is categorised according to geometrical components, agent attributes, agent decision making, and agent movement.

- Section 3 – **Theoretical Model Specification.**

The theories implemented within MassMotion to simulate human behaviour in an evacuation may be summarised according to:

- agent decision making / route selection – based on specified events and a ‘Least Cost’ algorithm;
- agent movement – is defined within the framework of a ‘Social Forces’ model.

The references supporting the theories and models forming the basis for MassMotion (and their suitability) for the representation of human behaviour during an evacuation) are provided.

- **Section 4 – MassMotion Verification.**

The verification testing has been conducted to demonstrate that the theory has been correctly implemented within MassMotion (and that the model predictions are in accordance with the inputs and the theory specification). The tests are aimed at addressing the following key elements of verification:

- **Component Testing** – Checking that each individual component of the MassMotion software performs as intended.
- **Functional Verification** – Checking that the MassMotion model possesses the ability to exhibit the range of capabilities required to perform the intended simulations. This requirement is task specific. To satisfy functional verification, the MassMotion user manual sets out (in a comprehensible manner) the complete range of model capabilities [1].
- **Qualitative Verification** – Demonstrates that the MassMotion model is able to reproduce key aspects of human behaviour consistent with ‘real life’ in an evacuation event.
- **Quantitative Verification** – Demonstrates that MassMotion predictions are in accordance with the inputs and the theory specification

The verification tests consist of a series of elementary test scenarios.

- **Section 5 – MassMotion Validation.**

The final step of the process is to demonstrate that MassMotion provides a sufficiently accurate representation of reality, by demonstrating that model predictions compare sufficiently well with experimental / observed evacuation events (and / or predictions from other evacuation simulation software).

- **Section 6 – Discussion.**

Total model verification and validation is not possible. The issue of ‘uncertainty’ is discussed in light of the verification and validation documented in this report.

2 MassMotion

2.1 Introduction

MassMotion is developed by Oasys Software Limited, a wholly owned subsidiary of Arup Group Limited. It is ISO9001-TickIT certified [9], indicating that it's development satisfies the international quality management system standards for software.

MassMotion is a pedestrian dynamics and evacuation simulation program. It features 3-dimensional environments, automatic agent way-finding and discrete event logic to model different types of scenarios. In the context of this document, it is intended to enable designers to make informed decisions about the evacuation planning and operation of complex facilities.

2.2 History

Table 1 documents the MassMotion development history.

Version	Build	Release Date
7.0	7.0.5.0	Feb-2015
6.1	6.1.1.8	Oct-2014
5.5	5.5.0.2	May-2013
5.0	5.0.6.4	Sep-2013
4.5	–	Nov-2011
4.0	–	Apr-2011

Table 1: MassMotion Development History

This report is based on the latest version of MassMotion.

2.3 Geometrical Components

Within MassMotion, the physical environment is represented by a series of geometrical components. Table 2 lists the geometrical component types available.

Actors	Description
Floors	Horizontal regions of the physical environment on which agents can walk. Agent movement is constrained by the boundaries of the floors.
Links	A physical horizontal connection where agents transition from one geometric component to another.
Stairs, Ramps and Escalators	A physical vertical connection where agents transition from a geometric component at one level to a geometric component at another level.
Portals (Entry and Exit)	Agents enter or exit a simulation through a portal (or an associated floor). Entry portals introduce agents to the model. Exit portals define the end goal of the agents.
Barriers and Obstacles	Barriers and obstacles restrict the movement of agents within the physical environment.
Server Processing	Define a one-way circulation element that may be precisely controlled. (Often utilised for passenger processing or security areas.)

Table 2: MassMotion Geometrical Component Types

2.4 Agents

Within MassMotion, agents are created at the start of a simulation through the use of entry portals. Agents do not occupy any space in a geometry prior to the start of a simulation. All agents are, then, created over a given time period (minimum of 1second). Entry portals have the capability to create agents directly on the portal or randomly on the associated floor connected to the portal.

2.5 Agent Attributes

Agent attributes (see Table 4) are the parameters which define how the agent

- interacts with the geometry components,
- interacts with other agents, and
- makes decisions.

Agent attributes are mandatory: these are provided with default values or are assigned randomly from a uniform probability distribution (the limits of which are defined by minimum and maximum values).

2.6 Agent Route Selection

Agents are placed in the physical environment (defined by geometrical components) and are assigned goals (e.g. the need to evacuate via an exit portal). The behavioural profile of an agent compels it to make a series of choices and, subsequently, execute actions that will lead them to their goal.

Each agent:

- is provided with an origin and destination matrix at the outset of the simulation (i.e. the agent itinerary);
- makes a series of choices to arrive at their destination based on their itinerary and behaviour profile.

The route selection of an evacuating agent can be specified in two ways:

- **Least Cost** – Agents travel via the ‘easiest’ route. Agents are aware of all / some exit portals (at the start of the simulation and as exit portals become available / unavailable). The effort, or ‘Cost’, associated with each route (to an exit portal of which they are aware) is calculated for the agent at each time step. The agent will take the ‘Least Cost’ path to an exit portal.
- **Specified Destination** – An exit portal is specified for each agent. The agent will take the ‘Least Cost’ route to the specific exit portal.

Agents have the ability to recognise congestion. They will consider alternative routes, based on their familiarity with the environment, adapting to current conditions.

MassMotion performs a dynamic calculation, at each time step for the duration of the simulation, throughout the model. Agents are able to adapt to their surroundings based on evolving situations (the dynamic availability / unavailability of exit portals for example) rather than being restricted by pre-defined agent parameters.

2.7 Agent Movement

Agents move through the physical environment. The speed at which an agent moves is a function of:

- the individual characteristics (e.g. gender, age, size) of the agent;
- the physical surroundings (e.g. spatial environment and the geometrical component on which the agent is located);
- the proximity of other agents.

The movement of agents through the model is a reflexive process implemented via a ‘Social Forces’ algorithm. At each time step, ‘forces’ act upon the agents causing them to move accordingly. The ‘Social Forces’ algorithm has been calibrated in accordance with Fruin’s Level of Service model developed for pedestrian planning.

2.8 Comparison with Other Software Specifications

The National Institute of Standards and Technology, Technical Note 1680 [10], provides a standardised list of features for some of the most prominent evacuation models on the market. Table 3 reproduces part of this review for MassMotion, Simulex [11], STEPS [12], Legion [13] and buildingEXODUS [14].

	MassMotion	Simulex	STEPS	Legion	building EXODUS
Modelling Methodology	Behavioural	Partial Behavioural	Behavioural	Behavioural	Behavioural
Purpose	Any Building Type	Any Building Type	Any Building Type	Any Building Type	Any Building Type
Grid / Structure	Continuous	Continuous	Fine Node	Continuous	Fine Network
Perspective of Model / Occupant	Individual and Individual / Global	Individual	Individual	Individual	Individual
Behaviour	Artificial Intelligence / Probabilistic	Implicit	Conditional / Probabilistic	Artificial Intelligence / Probabilistic	Implicit
Movement	Conditional (Fruin Speed-Density)	Inter-person Distance (Fruin Speed Density)	Inter-person Distance / Emptiness of Next Grid Cell	Inter-person Distance / Conditional	Potential, Emptiness of Next Grid Cell
Route Choice	Conditional	Shortest / Altered Distance Map	Conditional	Conditional	Various
Validation	Codes / Drills / Literature / Other Models	Drills / Literature / Third Party	Drills / Validation Against Past Experiment Literature	Codes / Drills / Validation Against Past Experiment Literature / Third Party Validation	Drills / Literature / Other Models / Third Party

Table 3: Features of Evacuation Models

3 Theoretical Model Specification

3.1 Context

The data and underlying theories which MassMotion employs are those based on general human behaviour observed during circulation, i.e. they are not specific to / for evacuation. During an evacuation, it is commonly observed that both normalcy bias and optimism bias occur, i.e. people often think that they are not in danger and that nothing bad will happen to them [15]. As such, human behaviour during an evacuation and normal circulation are (generally) comparable. If the level of risk perceived by an individual increases, e.g. as a result of seeing fire / smoke within close proximity, then the individual is likely to adapt their behaviour according to the level of risk perceived.

With the exception of those within close proximity of fire / smoke, or for events where considerable fire / smoke spread occurs, the majority of people during an evacuation would not be directly exposed to, or be aware of, fire / smoke. The level of risk perceived by the majority of people during an actual evacuation is, therefore, likely to be low (without additional information being provided to indicate otherwise).

In addition, an evacuation modelling analysis would typically preclude the exposure of people / agents to fire / smoke as part of the acceptance criteria (with the understanding that those people / agents initially within close proximity to fire / smoke would move to an exit or protected area promptly).

The level of risk perceived by the majority of people / agents within a typical evacuation model is, therefore, likely to be low. Consequently, the underlying data and theories employed within MassMotion, though based on general human behaviour observed during circulation, are deemed appropriate for modelling human behaviour during an evacuation.

For specific engineering applications where it is likely that evacuees will experience a heightened level of perceived risk, the modeller should determine:

- the extent to which the underlying theories and data remain valid;
- whether alteration of the default configurable parameters (e.g. decreasing pre-evacuation times, increasing travel speeds) might yield more probable predictions.

3.2 Agent Motion

In MassMotion, agent motion is separated into an agent decision making process and an agent movement process:

- Agents are given a goal as defined by an event. The contemplative agent decision making process analyses distance, congestion, and terrains between the origins and destinations to develop route costs to the agent goals. This is used to select the most appropriate route for an agent inside the dynamically changing environment.
- The reflexive agent movement process (see Figure 1) governs an agents basic movements and responses to the environment, i.e. agents navigate through the environment avoiding obstructions and other agents.

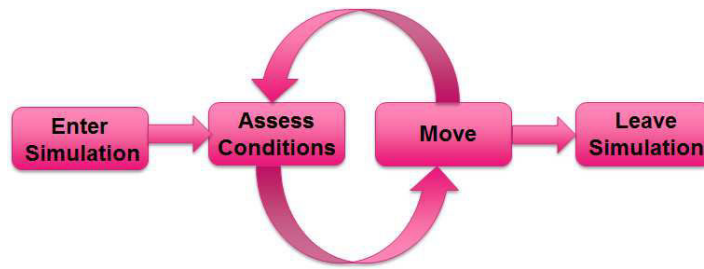

Figure 1: MassMotion Reflexive Movement Process

The following sub-sections outline the key functional components of MassMotion for evacuation modelling. A more detailed description of each component can be found in the MassMotion User Manual [1].

3.3 Agent Events

Once the MassMotion physical environment is defined (using the geometrical components), agent events are created to initiate, control or influence agent flow during a simulation.

Agent event properties include:

- **Origin** – The entry portal through which the agent enters the physical environment of the model.
- **Start Time** – The simulation time at which the evacuation is initiated.
- **Pre-evacuation Time** – The duration for which the agent is held at its initial location.
- **Destination** – The target or goal for an agent: either
 - a specific exit portal in the physical environment, or
 - the ‘Least Cost’ exit portal as determined (by MassMotion) dynamically.
- **Simulation Duration** – Duration of the simulation of the evacuation event.

Events can be specified to all agents, proportions of agents or individual agents, to better represent the evacuation scenario of interest. (Events may also be defined to represent the opening / closing of entry and exit portals.)

3.4 Agent Attributes

Within MassMotion, agents are assigned physical and behavioural attributes. The default physical, movement, and route choice attributes assigned to agents are outlined in Table 4. (Where a minimum and maximum value are stated, the attribute is assigned randomly from a uniform probability distribution between the defined values for each simulation.)

	Parameter	Default Data	Basis of Default Values
Movement	Body Radius (m)	0.25	Fruin [5][6] discusses a body ellipse of dimension 0.6m by 0.4m with an area of 0.2m ² . A 0.25m radius circle yields an area that is nearly identical while being far more efficient in computing agent movements and interactions.
	Preferred Horizontal Terrain Walking Speed Distribution (m/s)	Minimum = 0.65 Maximum = 2.05 (Mean = 1.35 Standard Deviation = 0.25)	The default preferred horizontal terrain walking speed distribution range (0.65m/s to 2.05m/s – uniformly distributed) is based on Fruin's [5][6] observations of commuter speed profile for a range of ages and genders.
	Stair (Up – Stair Angle X) Impact on Agent Speed (% of Preferred Horizontal Terrain Walking Speed)	(0° < X < 27°): 42.5 (27° ≤ X ≤ 32°): 42.5 – 37.8 (X > 32°): 37.8	The default preferred stair walking speed distribution ranges is based on Fruin's [5][6] observations of commuter speed profile for a range of ages and genders.
	Stair (Down – Stair Angle X) Impact on Agent Speed (% of Preferred Horizontal Terrain Walking Speed)	(0° < X < 27°): 57.4 (27° ≤ X ≤ 32°): 57.4 – 49.8 (X > 32°): 49.8	(Note: Linear interpolation is applied to the % of the preferred horizontal terrain walking speed for 27° ≤ X ≤ 32°.)
	Ramp (Up – Ramp Angle X) Impact on Agent Speed (% of Preferred Horizontal Terrain Walking Speed)	(0° < X < 5°): 100 (5° ≤ X ≤ 10°): 88.5 (10° ≤ X ≤ 20°): 88.5-75.0 (20° < X): 75.0	The default preferred ramp walking speed distribution ranges is based on a study referenced by Fruin [5][6] of controlled experiments of soldiers on a treadmill walking at varying inclines.
	Ramp (Down – Any Angle) Impact on Agent Speed (% of Preferred Horizontal Terrain Walking Speed)	100.0	
	Maximum Acceleration (m/s ²)	3.0	The default maximum acceleration, turning rate and shuffle factor is based on qualitative model observations and sensitivity analysis by Oasys.
	Maximum Turn Rate (degrees/s)	45.0	
	Shuffle Factor (% of Preferred Horizontal Terrain Walking Speed Below Which Agents can Shuffle in Any Direction)	0.1	
	Direction Bias	Direction: Keep Right Strength: Strong	The default direction bias is calibrated to yield crowd characteristics (in terms of flow and motion) that are consistent with Fruin's Levels of Service A to F [5][6].

	Parameter	Default Data	Basis of Default Values
			The 'Keep Right' value was selected based on an observed preference (in a number of countries) to favour moving to the right when resolving movement conflict.
Route Choice	Horizontal Distance Cost (factor)	Minimum = 0.75 Maximum = 1.25	The underlying network route costs, that the agents respond to, are based on the costs for journey segments in the Transport for London, Business Case Development Manual [16].
	Vertical Distance Cost (factor)	Minimum = 0.75 Maximum = 1.25	
	Queue Cost (factor)	Minimum = 0.75 Maximum = 1.25	The default variability ranges are intended to produce stochastic variation within a population where route options have very similar costs, without significantly altering the mean distribution of route choices.
	Processing Cost (factor)	Minimum = 0.75 Maximum = 1.25	

Table 4: Default Agent Attributes

The default agent attributes, indicated in Table 4, need not be assigned to an agent as user defined values may be specified. This allows the modeller to have additional control of the agent attributes within the evacuation model. In all cases, it is recommended that the modeller assess:

- the validity of the default agent attributes with respect to the evacuation scenario of interest;
- whether alternative values, drawn from appropriate published literature presenting reliable agent attribute data, are more appropriate.

All input data should be documented and justified within the documentation describing the scenario, data and simulation predictions.

In addition to these user configurable parameters, there are also a number of 'hard-coded' parameters which influence low level agent behaviour, e.g. parameters associated with the Social Forces model. Testing such parameters is beyond the scope of this document.

3.5 Agent Route Selection

MassMotion manages the complexity of the physical environment by automatically creating a network from the geometric components (Figure 2).

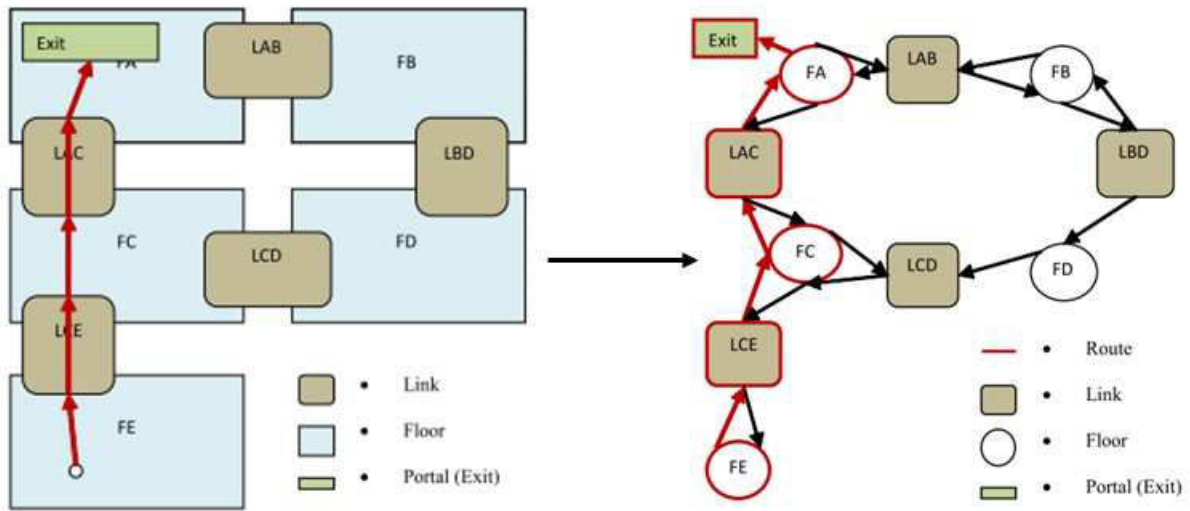

Figure 2: MassMotion Translation of a Floor / Link System into a Network

MassMotion manages these network assignments individually without the need for the modeller to manually create or maintain them.

The agent route selection process is based on the network.

An individual agent selects the route between the origin and destination points. The route selection within the network is based on the perceived costs of all the available routes that bring the agent to its ultimate goal without back-tracking.

Cost perception is the process by which an agent analyses the distance, congestion, and terrain type in order to assign costs to all the routes available to the agent. The most cost effective route is chosen. The total route cost (measured in time (seconds))

$$Cost = \left(W_D \times \left(\frac{D_G}{V} \right) \right) + (W_q \times Q) + (W_L \times L)$$

where:

$Cost$ = perceived total travel time along the route (s);

W_D = 'distance' weight (agent property) (-);

D_G = total distance from the agent position to the ultimate goal (m);

V = desired velocity of the agent (agent property) (m/s);

W_q = 'queue' weight (agent property) (-);

Q = expected time in queue before reaching link entrance (s);

W_L = 'geometric component traversal' weight (agent property) (-);

L = geometric component type cost (s).

The cost calculation is randomised (assigned different modifiers) slightly such that a statistically large population sample size with different behaviours is represented.

Flexibility within the MassMotion solution algorithm allows agents to modify their route selection dynamically (i.e. during the simulation) according to the local conditions.

Sources of Literature

Kuffner, J.J.Jr., Goal-directed Navigation for Animated Characters Using Real-time Path Planning and Control, Proceedings of CAPTECH 1998, 1998 [17].

Dijkstra, E.W., A Note on Two Problems in Connexion with Graphs, Numerische Mathematik, 1:269–271, 1959 [18].

Veeraswamy, A., Computational Modelling of Agent Based Path Planning and the Representation of Human Way-finding Behaviour within Egress Models, PhD Thesis, University of Greenwich, 2011 [19].

3.6 Agent Movement

The MassMotion agent movement process includes spatial analysis, where each individual agent is aware of all walk-able surfaces of the physical environment (considering obstructions and other agents within their immediate vicinity). An agent is aware of all the complete paths between its location and its goal.

The preferred travel speed of an individual agent is a function of the terrain (or geometric component). The actual travel speed of the agent is also a function of the density of all the agents in the immediate vicinity of the agent, and is modified by MassMotion accordingly. (This represents the human preference to maintain a given spacing between persons according to the average speed at which they are moving).

The terrain, agent density and agent speed relationship is configured according to the work of Fruin [5][6] (Figure 3).

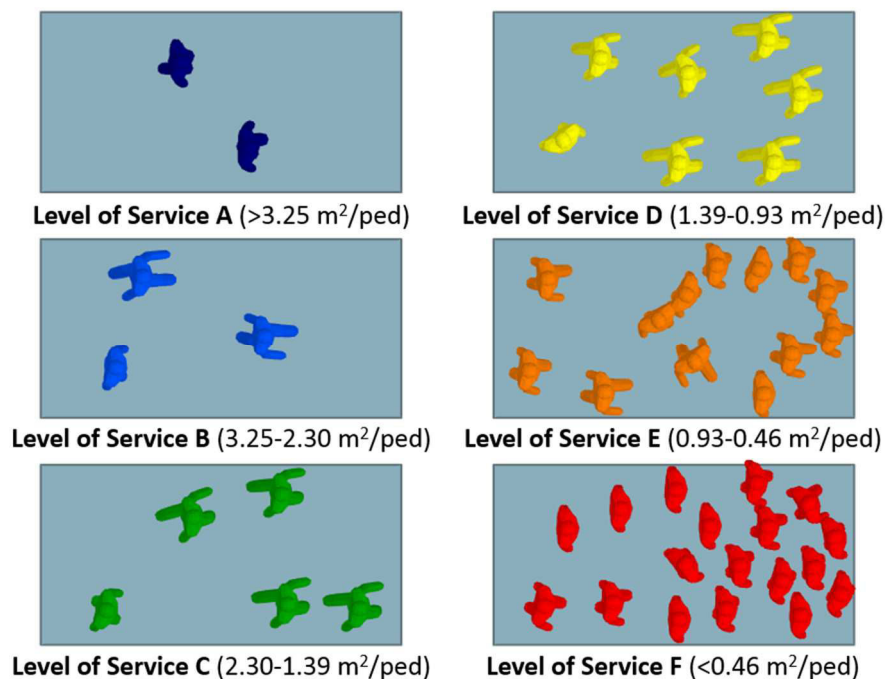

Figure 3: Illustration of Fruin 'Levels of Service (Walkways)'

The Fruin ‘Levels of Service’ are based on data (travel speeds) collected for different terrains in the New York Subway in the 1970s.

Fruin’s work is widely cited in a number of evacuation modelling texts (e.g. IMO 1238 [7], SFPE Handbook [20] PD 7974-6 [21]), and used within in a number of evacuation models as default parameters (e.g. buildingEXODUS [14], Pathfinder [22]).

Sources of Literature

Fruin, J., Pedestrian Planning and Design, Metropolitan Association of Urban Designers and Environmental Planners, New York, 1971 [5].

Fruin, J, Pedestrian Planning and Design, Revised Edition, Elevator World Inc., Mobile, AL, 1987 [6].

IMO, MSC.1/Circ. 1238, Guidelines for Evacuation Analysis for New and Existing Passenger Ships. International Maritime Organization, London, UK, 2007 [7].

SFPE Handbook of Fire Protection Engineering, Third Edition, NFPA, 2002 (Chapter 3-13, Proulx, G., Movement of People: The Evacuation Timing) [20].

PD 7974 The Application of Fire Safety Engineering Principles to Fire Safety Design of Buildings – Part 6: Human Factors: Life Safety Strategies – Occupant Evacuation Behaviour and Condition, British Standards Institute, 2004 [21].

Galea, E.R., Gwynne, S., Lawrence, P.J., Filippidis, L., Blackshields, D., Cooney, D., buildingEXODUS User Guide and Technical Manual V 5.0, Fire Safety Engineering Group, University of Greenwich, 2011 [14].

Pathfinder Technical Reference, Thunderhead Engineering Consultants Inc., 2009 [22].

3.7 Social Forces

Within MassMotion, agents are capable of adjusting to dynamically changing conditions within the physical environment (e.g. avoiding obstructions and other agents) utilising a modified Social Forces model [2][3][4].

The Social Forces model assumes that the motion of an agent can be predicted from the ‘social forces’ to which the agent is subject. These ‘social forces’ are a measure of the motivations of the agent to perform certain actions (movements) and comprise of:

- a term describing the acceleration / deceleration towards the desired velocity of motion;
- a term(s) describing the agents desire to maintain a preferred distance from the boundaries of geometric components and from other agents – ‘repulsive forces’;
- a term(s) describing the agents desire to achieve its goals – ‘attractive forces’.

The resulting equations of motion are nonlinearly coupled Langevin equations [2][3].

A schematic representation of the process leading to behavioural change (i.e. modification of agent route choice and / or agent movement) is illustrated in Figure 4 [2][3].

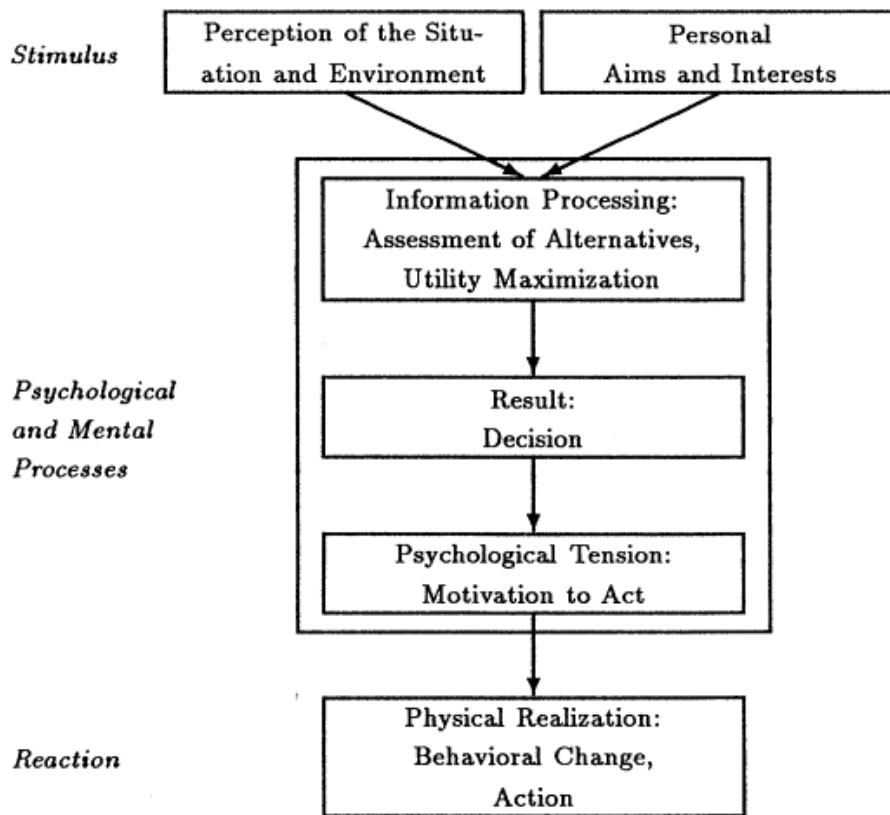

Figure 4: Schematic Representation of Processes Leading to Behavioural Changes

This proposes that a sensory stimulus (e.g. a change in the physical environment) causes a behavioural reaction (e.g. modification of the agent route selection and / or agent movement) that depends on the aims of the agent and is chosen from a set of alternatives with the objecting of utility maximisation (e.g. arriving at an exit portal in the shortest possible time).

Within MassMotion, the Social Forces algorithm generates a series of component forces (shown in Table 5) which are used to determine the movement of an agent (with varying influence according to the local environment).

Component Force	Colour	Description
Goal	Bright Green	Attractive force moving the agent towards its goal / target at the desired travel speed.
Neighbour	Bright Yellow	Repulsive force from each neighbouring agent (to maintain adequate separation between agents).
Drift	Purple	Repulsive force moving the agent in the direction of the preferred bias when faced with oncoming agents.
Collision Veer Force	Turquoise	Repulsive force to prevent anticipated collisions with a neighbouring agent.
Collision Yield Force	Orange	Repulsive force (and / or torque) causing the agent to slow down avoid a collision with a neighbouring agent.
Cohesion	White	Attractive force moving the agent towards the centroid of neighbouring agents with similar goals / targets.
Marshal / Orderly Queuing	Grey	Attractive force pushing the agent towards the middle of a goal / target when approaching.
Corner	Brown	Repulsive force enabling the agent to navigate a corner.
Panic	Pink	Strong force pulling the agent back to a walk-able surface (when the agent attempts to move outside the boundaries of the walk-able surface).
Obstacle (Constrained Net Force)	Blue	Resulting net force.
Obstacle (Constrained Velocity)	Black	Resulting velocity.

Table 5: Social Forces Model – Component Forces

Notes:

- ‘Obstacles’ do not generate a repulsive force: they are used to constrain other forces.
- When component forces are summed, the resulting net force is reduced such that it does not push the agent into a boundary.

Sources of Literature

Helbing, D., Molnar, P., Social Force Model for Pedestrian Dynamics, Physical Review E, Volume 51, Issue 5, pp4281-4286, 1995 [2].

Helbing, D., Molnar, P., Social Force Model for Pedestrian Dynamics II, Institute of Theoretical Physics, University of Stuttgart, 70550, Germany, 1995 [3].

Helbing, D., Farkas, I., Vicsek, T., Simulating Dynamical Features of Escape Panic, Nature, 407, 487-490, 2000 [4].

Song, W.G., Yu, Y.F., Wang, B.H., Fan, W.C., Evacuation Behaviors at Exit in CA Model with Force Essentials: A Comparison with Social Force Model, Physica A 371, 658-666, 2006 [22].

Johansson, A., Helbing, D., Shukla, P.K., Specification of the Social Force Pedestrian Model by Evolutionary Adjustment to Video Tracking Data, Advances in Complex Systems, 10(4), 271-288, 2009 [23].

Korhonen, T., Heliövaara, S., FDS+Evac: Modelling Pedestrian Movement in Crowds – Technical Reference and User’s Guide, VTT Working Papers 119, 2009 [24].

4 MassMotion Verification

The verification testing has been conducted to demonstrate that the theory is correctly implemented within MassMotion (and that the model predictions are in accordance with the inputs and the theory specification).

The verification tests (presented in Appendix A) are classified into the following aspects of human behaviour during an evacuation:

- pre-evacuation behaviour;
- travel speed;
- physicality;
- decision making;
- crowd dynamics.

Tests 1-14 represent a standard set of evacuation modelling verification tests specified in International Maritime Organisation (IMO) 1238 [7] and National Institute of Standards (NIST) Technical Note 1822 [8]. (Note that four of the tests specified in NIST 1822 cannot be completed via explicit or direct component representation within MassMotion as the software does not currently have functionality to explicitly / directly represent the requirements. The verification tests not included are:

- Test 2.5 – Reduced Visibility versus Walking Speed;
- Test 2.6 – Occupant Incapacitation;
- Test 2.7 – Elevator Usage;
- Test 2.9 – Group Behaviour.)

Verification tests, additional to those specified by IMO 1238 and NIST 1822, have also been conducted to verify other aspects of the MassMotion model.

A summary of the verification tests undertaken is presented in Table 6.

MassMotion Verification Tests						
ID	Title	Category	NIST / IMO	Sensitivity	Pass / Fail	
1	A1 Corridor Walking Speeds	Speed	Yes	No	Pass	
2	A2 Ascending Stair Walking Speeds	Speed	Yes	Yes	Pass	
3	A2 Descending Stair Walking Speeds	Speed	Yes	Yes	Pass	
4	A3 Exit Flow Rates	Crowd	Yes	Yes	Pass	
5	A4 Pre-evacuation Time	Pre-evacuation	Yes	No	Pass	
6	A5 Movement Around Corners	Physicality / Crowd	Yes	No	Pass	
7	A6 Assignment of Parameters	Decision	Yes	No	Pass	
8	A7 Counter-flow	Crowd	Yes	No	Pass (See Test)	
9	A8 Crowd Exit Usage	Decision	Yes	No	Pass	
10	A9 Exit Allocation	Decision	Yes	No	Pass	
11	A10 Stair Congestion	Crowd	Yes	No	Pass	
12	A11 Movement Disabilities	Physicality / Crowd	Yes	Yes	Pass (See Test)	
13	A12 Affiliation	Decision	Yes	No	Pass	
14	A13 Dynamic Availability of Exits	Decision	Yes	No	Pass	
15	A14 Stair Merging	Crowd	No	Yes	Pass	
16	A15 Stair Flows	Crowd	No	Yes	Pass	
17	A16 Passage Constrictions One-way	Crowd	No	No	See Note	
18	A17 Passage Constrictions Two-way	Crowd	No	No	See Note	
19	A18 Escalator Flows	Crowd	No	No	See Note	
20	A19 Stair Flow One-way	Crowd	No	No	See Note	
21	A20 Stair Flow Two-way	Crowd	No	No	See Note	
22	A21 Corner Flow One-way	Crowd	No	No	See Note	
23	A22 Corner Flow Two-way	Crowd	No	No	See Note	
24	A23 Switchback Stair One-way	Crowd	No	No	See Note	
25	A24 Vertical Route Choice	Decision	No	No	See Note	
26	A25 Horizontal Route Choice	Decision	No	No	See Note	
Note: Verification tests 17-26 are to be completed by Oasys for the next release of MassMotion. (Scheduled for End 2015.)						

Table 6: Summary of MassMotion Verification Tests

Certain verification tests are heavily influenced by the use of components of the model which use random sampling. Random sampling is used to assign random values for parameters based on a distribution for a given simulation for the test. Repeat simulations for the same test may result in different random values being assigned. This can lead to a variation in predictions between different simulations for the same test. For verification tests where such random sampling is expected to heavily influence the predictions, 50 simulations were undertaken in accordance with the guidance of IMO 1238 in order for the overall predictions to reflect the range of assigned parameters.

To demonstrate how changes in a given parameter value affects the overall MassMotion predictions, sensitivity analysis has been conducted for certain verification tests. Results from such analysis can be used to inform anticipated trends when small design changes are proposed (for specific engineering applications).

For all the verification tests presented, MassMotion predictions are in agreement with the relevant NIST and IMO acceptance criteria.

It was noted that two verification tests demonstrated a high sensitivity of the prediction to small changes in the input parameter: these are marked 'See Test' (where additional information is provided). Changes to the highlighted input parameter should be considered carefully, as otherwise there is an increased potential for unrealistic predictions.

5 MassMotion Validation

The validation cases summarised in this section compare actual and / or modelled data with the predictions from MassMotion.

The MassMotion validation cases are summarised in Table 7 (Published) and Table 8 (Unpublished).

MassMotion Validation Cases (Published)		
Reference	Description	Conclusions
[26]	<p>Location: Toronto, Canada. Building: Union Train Station. Type: Train Station. Occupancy: 10,348. Data Source: Normal Daily Usage Data Analysed: Route Choice.</p>	<p>MassMotion generated comparable results with respect to the number agents using each of the 14 exits. (The percentage difference between the observed and predicted values is <u>0.0% - 2.1%</u>, with a mean of 0.9%.)</p>
[27][28]	<p>Location: London, United Kingdom. Building: One Canada Square. Type: High-rise Office (50 Floors, 4 Stairwells). Occupancy: 5,469 (All Occupants). Data Source: Evacuation Drill. Data Analysed: Stair / Route / Exit Usage, Flow Rates, Total Evacuation Times, Other Evacuation Model Results.</p>	<p>MassMotion predicted an evacuation time which was <u>9.5%</u> greater than the observed evacuation time of 20 minutes. MassMotion more closely predicted the actual total evacuation time for One Canada Square compared to Legion (13 minutes 30 second) with a <u>10%</u> difference recorded between the two model results. MassMotion more closely predicted the actual total evacuation time for One Canada Square compared to STEPS (17 minutes) with a <u>15%</u> difference recorded between the two model results.</p>
[27][28]	<p>Location: New York, US. Building: 155 Avenue of the Americas. Type: Medium-rise Office (6 of 15 Floors Modelled, 2 Stairwells). Occupancy: 232. Data Source: Evacuation Drill. Data Analysed: Stair / Route / Exit Usage, Flow Rates, Total Evacuation Times.</p>	<p>MassMotion produced evacuation times which were <u>5.6%</u> greater than the observed evacuation time of 7 minutes, 24 seconds. Comparable exit flow rates and exit usage were observed.</p>
[27][28]	<p>Location: London, United Kingdom. Building: 10 Hanover Square. Type: High-rise Office (22 Floors, 2 Stairwells). Occupancy: 1,130. Data Source: Evacuation Drill. Data Analysed: Stair / Route / Exit Usage, Flow Rates, Total Evacuation Times.</p>	<p>MassMotion produced evacuation times which were <u>1.4%</u> less than the observed evacuation time of 13 minutes.</p>

MassMotion Validation Cases (Published)		
Reference	Description	Conclusions
[27][28]	<p>Location: London, United Kingdom.</p> <p>Building: 85 Broad Street.</p> <p>Type: High-rise Office (30 Floors Modelled, 3 Stairwells.)</p> <p>Occupancy: 1,385.</p> <p>Data Source: Evacuation Drill.</p> <p>Data Analysed: Stair / Route / Exit Usage, Flow Rates, Total Evacuation Times.</p>	<p>MassMotion produced evacuation times which were <u>7.3%</u> less than the observed evacuation time of 18 minutes.</p>

Table 7: Summary of MassMotion Validation Cases (Published)

MassMotion Validation Cases (Unpublished)		
Appendix	Description	Conclusions
B1	<p>Location: London, United Kingdom.</p> <p>Building: (Anonymised)</p> <p>Type: High-rise Office (50 Floors, 4 Stairwells).</p> <p>Occupancy: 1,411 (Stair Users Only).</p> <p>Data Source: Evacuation Drill.</p> <p>Data Analysed: Stair / Route / Exit Usage, Flow Rates, Total Evacuation Times.</p>	<p>MassMotion predicted an evacuation time which was <u>12.2%</u> greater than the observed evacuation time of 22 minutes.</p> <p>Comparable stair discharge flow rates for the most used stairs were observed.</p> <p>Comparable times for the last occupant to leave each stair were observed.</p>

Table 8: Summary of MassMotion Validation Cases (Unpublished)

The validation cases demonstrate that MassMotion predictions are comparable to actual / modelled data.

6 Discussion

6.1 Summary

This report outlines:

- the requirements of MassMotion for simulating evacuations;
- how those requirements have been developed using existing concepts of human behaviour and modelling techniques; and
- the suitability of the theoretical models and data implemented within MassMotion for representing evacuation scenarios;
- the verification and validation testing of MassMotion.

6.2 Verification Testing

Verification testing of the MassMotion model has been performed in accordance with:

- International Maritime Organisation (IMO) 1238 [7];
- National Institute of Standards (NIST) Technical Note 1822 [8].

Additionally, testing of aspects of the model not included within the IMO 1238 and NIST Technical Note 1822 verification tests has been conducted.

The full range of verification tests undertaken is illustrated in Table 6.

Sensitivity testing has been applied to some of the verification tests to demonstrate the sensitivity of the prediction to changes in input parameters.

All the verification tests investigated passed the stated acceptance criteria. It was noted that two verification tests demonstrated a high sensitivity of the prediction to small changes in the input parameter: these are marked 'See Test' (where additional information is provided). Changes to the highlighted input parameter should be considered carefully, as otherwise there is an increased potential for unrealistic predictions.

Results from the verification tests indicate that MassMotion is able to predict the expected results for those cases tested.

6.3 Validation Testing

Validation studies, comparing MassMotion predictions with 'real world' evacuation events, evacuation drills and circulation events, were presented.

Results from the validation case studies demonstrate that MassMotion predictions were comparable to the actual data. In those cases studied, therefore, it may be concluded that MassMotion is able to represent the key aspects of human behaviour during an evacuation.

6.4 Uncertainty

As has been identified previously, total model verification and validation is not possible. There are multiple sources of uncertainty associated with the modelling process. Some of the key sources are itemised below.

- Inherent variability in the physical behaviour.

- Conceptualisation of the physical behaviour into a model suitable for consideration.
- Derivation of the mathematical model describing the conceptualised model.
- Implementation of the mathematical model as a numerical model in computer software.
- Inherent variability in the input data parameters required for the model.
- Uncertainty in the selection of the input data parameters.
- Lack of knowledge relating to the physical behaviour (and all the factors affecting it).
- Lack of knowledge relating to the model (conceptualised, mathematical and numerical).
- Lack of knowledge relating to the input data parameters.

Verification and validation provide a means to assess the suitability of a mathematical model (implemented as a numerical model in computer software) for its intended purpose of representing the physical behaviour by reducing the uncertainty wherever it is possible to do so.

In the context of MassMotion, and this verification and validation exercise specifically, the aim has been to:

- reduce the model (mathematical and model) and user (knowledge) uncertainties through the verification testing;
- reduce the model (conceptual), data and user (knowledge) uncertainties through the validation case studies.

The verification and validation testing undertaken for MassMotion is not exhaustive.

Where the specific application utilises aspects of MassMotion outside the range verified and / or validated, then, the uncertainty must be reduced (by mitigating the use of the components / sub-models where uncertainty exists or mitigating the uncertainty itself) as previously described.

The theories and data employed within MassMotion are those founded on observations derived from normal circulation behaviour where people are not exposed to a hazard or have a heightened level of perceived risk. For specific engineering applications where it is likely that evacuees will experience a heightened level of perceived risk, the modeller should determine:

- the extent to which the underlying theories and data remain valid;
- whether alteration of the default configurable parameters (e.g. decreasing pre-evacuation times, increasing travel speeds) might yield more probable predictions.

It is essential that the extent of the MassMotion verification and validation be considered, in the context of the specific application of interest, to assess the suitability of MassMotion for:

- representing the reality of an evacuation event in the environment of interest; and
- the extent to which any predictions from MassMotion supports the fire safety strategy.

This is particularly relevant when assessing the uncertainty in the core elements (Agent Route Selection, Agent Movement and Social Forces) of the MassMotion model.

6.5 Conclusion

Verification and validation (particularly) is an on-going process.

The verification and validation process provides confidence that MassMotion is capable of representing the key aspects of human behaviour in a variety of evacuation scenarios.

7 References

- [1] MassMotion v7.0, Manual, Oasys Software Limited, 2015.
- [2] Helbing, D., Molnar, P., Social Force Model for Pedestrian Dynamics, *Physical Review E*, Volume 51, Issue 5, pp4281-4286, 1995.
- [3] Helbing, D., Molnar, P., Social Force Model for Pedestrian Dynamics II, Institute of Theoretical Physics, University of Stuttgart, 70550, Germany, 1995.
- [4] Helbing, D., Farkas, I., Vicsek, T., Simulating Dynamical Features of Escape Panic, *Nature*, 407, 487-490, 2000.
- [5] Fruin, J., Pedestrian Planning and Design, Metropolitan Association of Urban Designers and Environmental Planners, New York, 1971.
- [6] Fruin, J, Pedestrian Planning and Design, Revised Edition, Elevator World Inc., Mobile, AL, 1987.
- [7] IMO, MSC.1/Circ. 1238, Guidelines for Evacuation Analysis for New and Existing Passenger Ships. International Maritime Organization, London, UK, 2007.
- [8] Ronchi, E., Kuligowski, E.D., Reneke, P.A., Peacock, R.D., Nilsson, D., The Process of Verification and Validation of Building Fire Evacuation Models, NIST Technical Note 1822, 2013.
- [9] Oasys website: [http://www.oasys-software.com/media/QA/QA%20Certificate%20\[2013-03-25%20to%202016-03-24\].pdf](http://www.oasys-software.com/media/QA/QA%20Certificate%20[2013-03-25%20to%202016-03-24].pdf), Accessed: 26-Mar-2015.
- [10] Kuligowski, E., Peacock, R.D., Hoskins, B.L., A Review for Building Evacuation Models, Second Edition, National Institute of Standards, Technical Note 1680, 2010.
- [11] IES Simulex User Manual, Integrated Environmental Solutions Inc., 2001.
- [12] STEPS (Simulation of Transient Evacuation and Pedestrian MovementS): User Manual, Unpublished, Mott Macdonald, 2003.
- [13] Legion International, <http://www.legion.biz/system/research.cfm>, 2003.
- [14] Galea, E.R., Gwynne, S., Lawrence, P.J., Filippidis, L., Blackshields, D., Cooney, D., buildingEXODUS User Guide and Technical Manual V 5.0, Fire Safety Engineering Group, University of Greenwich, 2011.
- [15] Gwynne, S.M.V., Hulse, L.M., Kinsey, M.K., Guidance for the Model Developer on Representing Human Behavior in Egress Models', *Fire Technology*, DOI: 10.1007/s10694-015-0501-2, 2015.
- [16] Business Case Development Manual, Transport For London, May 2013. (Appendix E 3.1)
- [17] Kuffner, J.J.Jr., Goal-directed Navigation for Animated Characters Using Real-time Path Planning and Control, Proceedings of CAPTECH 1998, 1998.
- [18] Dijkstra, E.W., A Note on Two Problems in Connexion with Graphs, *Numerische Mathematik*, 1:269–271, 1959.

- [19] Veeraswamy, A., Computational Modelling of Agent Based Path Planning and the Representation of Human Way-finding Behaviour within Egress Models, PhD Thesis, University of Greenwich, 2011.
- [20] SFPE Handbook of Fire Protection Engineering, Third Edition, NFPA, 2002. (Chapter 3-13, Proulx, G., Movement of People: The Evacuation Timing.)
- [21] PD 7974 The Application of Fire Safety Engineering Principles to Fire Safety Design of Buildings – Part 6: Human Factors: Life Safety Strategies – Occupant Evacuation Behaviour and Condition, British Standards Institute, 2004.
- [22] Pathfinder Technical Reference, Thunderhead Engineering Consultants Inc., 2009.
- [23] Song, W.G., Yu, Y.F., Wang, B.H., Fan, W.C., Evacuation Behaviors at Exit in CA Model with Force Essentials: A Comparison with Social Force Model, Physica A 371, 658-666, 2006.
- [24] Johansson, A., Helbing, D., Shukla, P.K., Specification of the Social Force Pedestrian Model by Evolutionary Adjustment to Video Tracking Data, Advances in Complex Systems, 10(4), 271-288, 2009.
- [25] Korhonen, T., Heliovaara, S., FDS+Evac: Modelling Pedestrian Movement in Crowds – Technical Reference and User’s Guide, VTT Working Papers 119, 2009.
- [26] Morrow, E., MassMotion: Simulating Human Behaviour to Inform Design for Optimal Performance, The Arup Journal 1/2010, 2010.
- [27] Rivers, E., Jaynes, C., Kimball, A., Morrow, E., Zarnke, M., Using Case Study Data to Validate 3D Agent-based Simulation Tool for Building Egress Modeling, Proceedings of the Fire and Evacuation Modeling Technical Conference 2011, 2011.
- [28] Rivers, E. Jaynes, C., Kimball, A., Morrow, E., Using Case Study Data to Validate 3D Agent-Based Pedestrian Simulation Tool for Building Egress Modeling, Proceedings Pedestrian and Evacuation Dynamics 2014, 2014.

Appendix A

Verification Tests

A1 Test 1: Corridor Walking Speeds

A1.1 Test Description

The test is in accordance with IMO 1238 Test 1 and NIST 1822 Test 2.1.

This test is used to verify that the model is able to represent an agent maintaining an assigned speed over time. (This is a critical aspect during the calculation of the Required Safe Egress Time of a building.)

The test utilises a walking speed that is representative of the walking speed of an adult (1m/s) and a length of corridor that is sufficient to test if the assigned agent speed is maintained over time.

A1.2 Aim of Test

The purpose of the test is to demonstrate that an agent can move along a corridor at a constant walking speed.

A1.3 Simulation Setup

The geometry consists of:

- a corridor 2m wide by 45m long;
- an entry portal at one end of the corridor;
- an exit portal at the other end of the corridor.

A journey was simulated where the agent travels from the entry portal to the exit portal.

The agent was assigned a preferred walking speed of 1.0m/s.

Within MassMotion, agents accelerate / decelerate to the preferred walking speed at a default rate of 3m/s^2 . To achieve a walking speed of 1.0m/s, the agent needs to travel 0.333m to reach the desired walking from a standing start. Two cordon lines are located along the corridor and separated exactly 40m from each other. The portals are offset from the cordon lines by a minimum of 0.333m to allow for the acceleration / deceleration of the agent.

The model is shown in Figure A1.1.

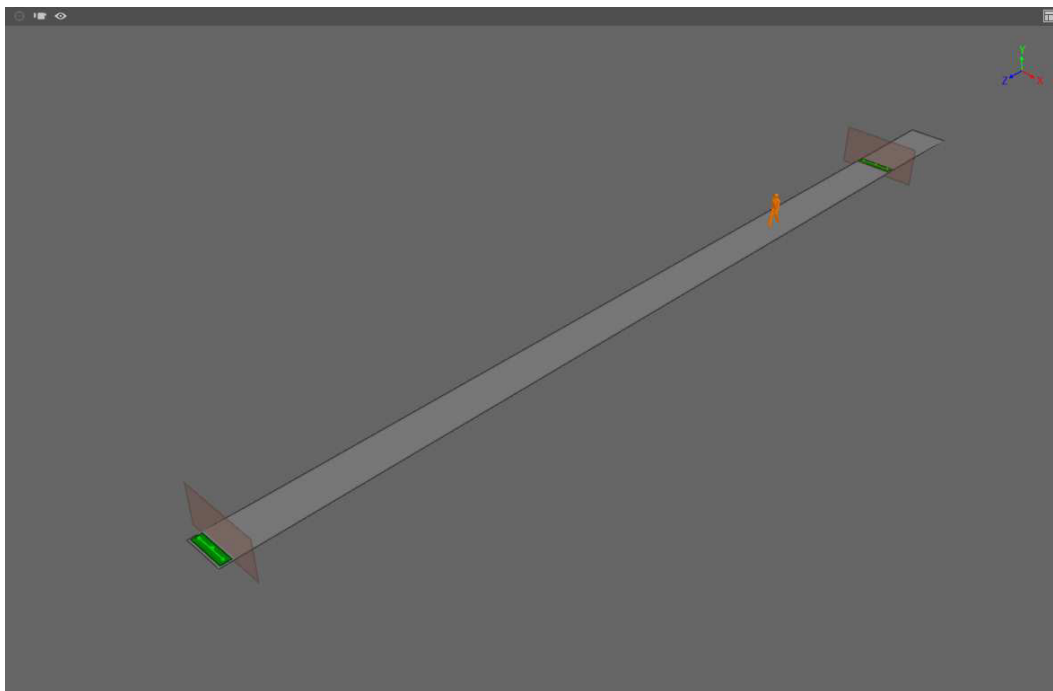

Figure A1.1: Simulation Set-up for Test 1

A1.4 Test Results

MassMotion predicted that the time for the agent to travel the 40m between the cordon lines is 40s, i.e. consistent with a constant walking speed of 1m/s. (See Figure A1.2.)

Agent ID	Start Time	End Time	Duration
11001	00:00:00	00:00:41	00:00:40

Figure A1.2: MassMotion Predictions for the Agent Trip Time

A1.5 Conclusion

The IMO 1238 Test 1 and NIST 1822 Test 2.1 has been conducted using MassMotion.

The procedures for the test stated in the IMO and NIST guidance are identical and only one simulation was considered.

The predictions indicate that MassMotion is able to reproduce the results stated in the IMO and NIST guidance given the configured parameters of the model.

Status: Pass.

A2 Test 2: Ascending Stair Walking Speeds & Test 3: Descending Stair Walking Speeds

A2.1 Test Description

The tests are in accordance with IMO 1238 Tests 2 and 3 and NIST 1822 Test 2.2.

The purpose of the test is to demonstrate that agents can move up or down a stair at a constant walking speed of 1 m/s.

The IMO 1238 tests state that a 10m stair should be used: the NIST 1822 test states that a 100m stair should be used. In all other respects, the tests are identical. Furthermore, both tests use the same MassMotion agent model. On this basis, the NIST 1822 Test 2.2 has been undertaken: it is considered that this test is suitable for demonstrating that the intent of IMO 1238 Test 2 and 3 is satisfied.

MassMotion applies a factor to the preferred level terrain walking speed of the agent to derive the preferred (horizontal) speed of the agent on the stairs. The default factors adopted in MassMotion are outlined in Table A2.1.

Stair Incline (degrees)	Factor (%)	
	Upward Stair	Downward Stair
Less than 27	42.5	57.4
Between 27 and 32	42.6 – 37.8 (Interpolate)	57.4 – 49.8 (Interpolate)
Greater than 32	37.8	49.8

Table A2.1: MassMotion Default Agent Attributes for Stairs

Three stairs, each with a different incline (as defined in Table A2.2), were assessed. Inclines close to 27° and 32° were avoided in order to avoid calculation rounding and potential migration of the factor into adjacent ranges.

Stair				
ID	Incline (degrees)	Length (m)	Height (m)	Traverse (m)
1	15.0	100.0	25.882	96.593
2	29.5	100.0	49.242	87.036
3	45.0	100.0	70.711	70.711

Table A2.2: Stair Inclines (and Dimension) Adopted

A2.2 Aim of Tests

The purpose of the test is to demonstrate that an agent can move up or down a stair at a pre-defined constant walking speed.

A2.3 Simulations Setup

Three 100m long and 2m wide stairs, at inclines of 15.0°, 29.5° and 45.0°, were created. (See Table A2.2.)

A 2m wide floor was created at each end of each stair.

Portals were created on each of the six floors.

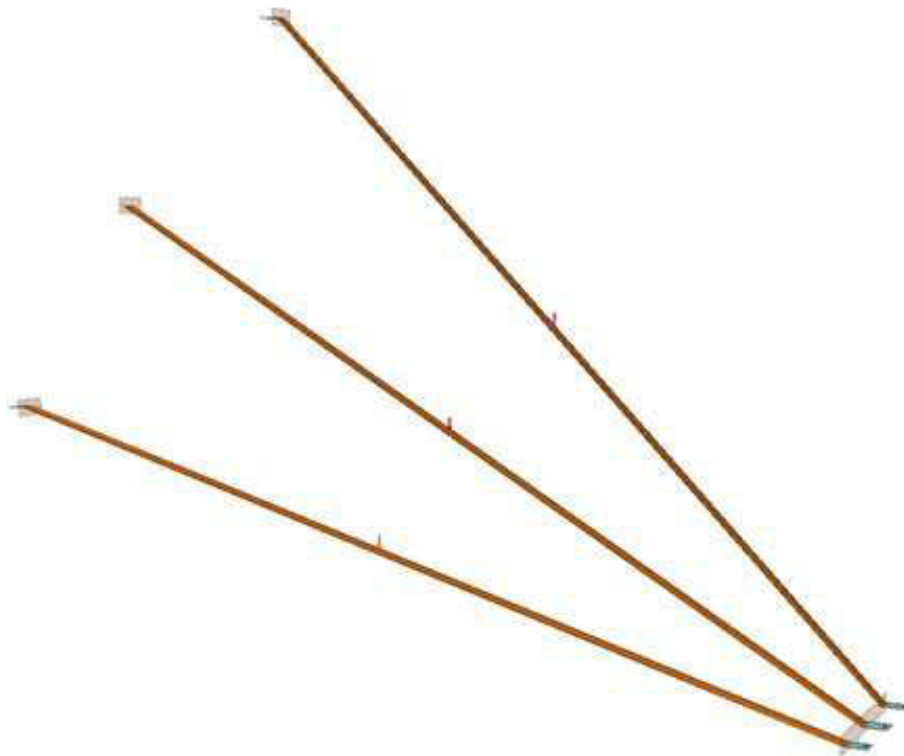

Figure A2.1: MassMotion Physical Environment

The test requires that agents walk at a constant speed of 1m/s up / down each stair. MassMotion derives the preferred horizontal walking speed on the stair from the product of the preferred level terrain (horizontal) walking speed and the factor appropriate to the stair incline and the direction of travel (up / down). Therefore, the agent preferred level terrain (horizontal) walking speed, S_{PLT} , is calculated from

$$S_{PLT} = \left(\frac{\text{Required Speed on Stair} \times \text{Cosine (Angle of Stair Incline)}}{\text{Stair Factor}} \right)$$

(See Table A2.3).

The agent attributes (e.g. constant speed) and ‘journey’ event were defined.

For Test 2, agents are generated by entry portals at the base of the stairs and the goal is set as the exit portals at the top of the stairs. For Test 3, agents are generated by entry portals at the top of the stairs and the goal is set as the exit portals at the base of the stairs.

Cordon lines at the base and top of each stair were created (to monitor the agent journey times by generating Trip Time tables).

(See Figures A2.2 and A2.3.)

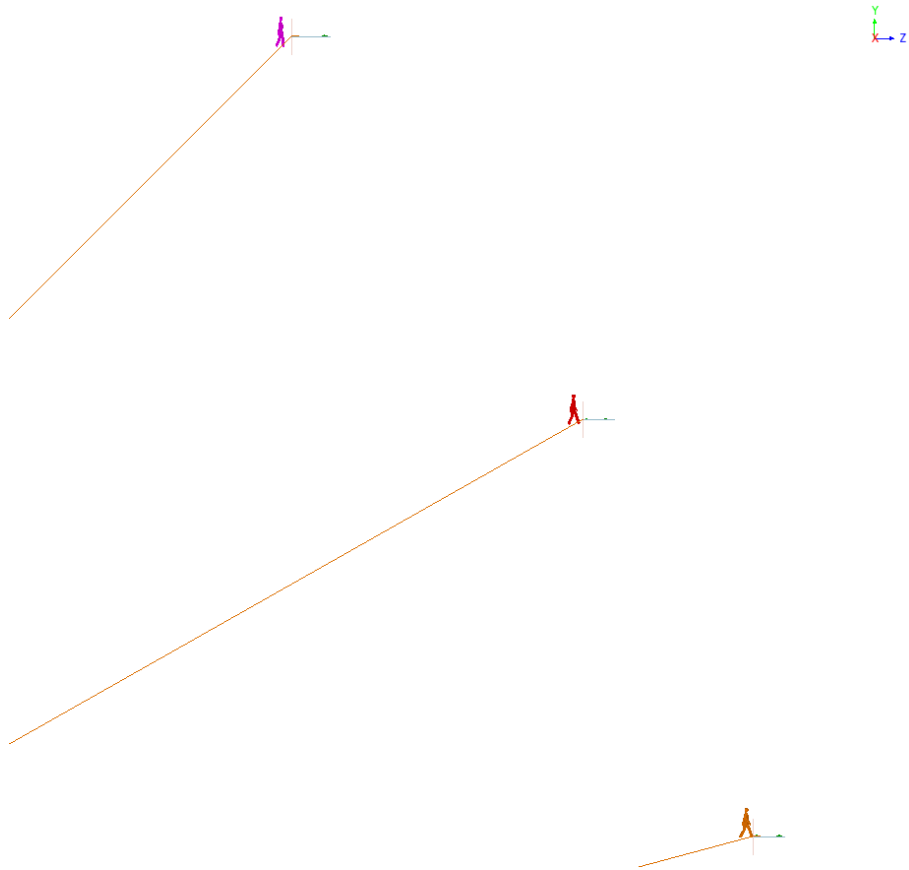

Figure A2.2: MassMotion Test 2

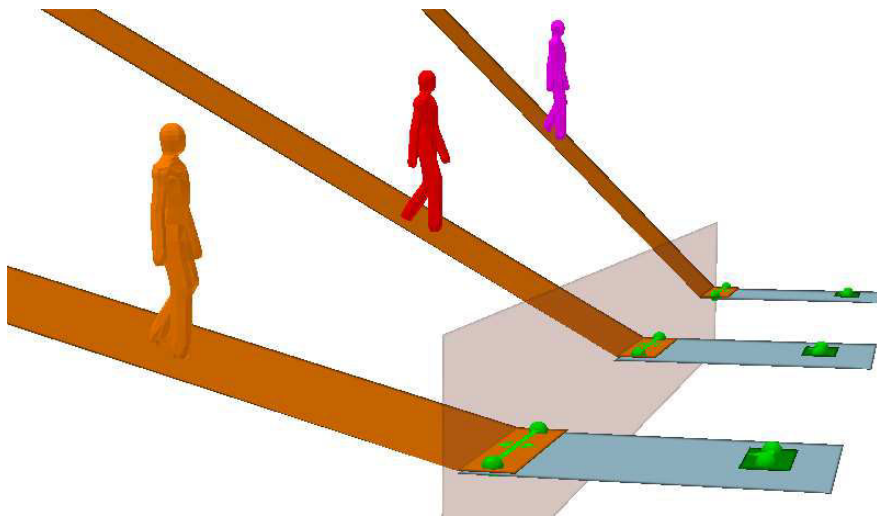

Figure A2.3: MassMotion Test 3

A2.4 Test Results

The MassMotion predictions are documented in the table below.

Test	Stair Incline	Preferred Level Terrain Walking Speed (Horizontal) (m/s)	Target Stair Travel Time (s)
2	15.0° Ascending	2.273	100
2	29.5° Ascending	2.165	100
2	45.0° Ascending	1.871	100
3	15.0° Descending	1.683	100
3	29.5° Descending	1.624	100
3	45.0° Descending	1.420	100

Table A2.3: MassMotion Predictions for Tests 2 and 3

The Trip Time tables with the MassMotion results for each of the cases investigated is shown in Figures A2.4 to A2.9.

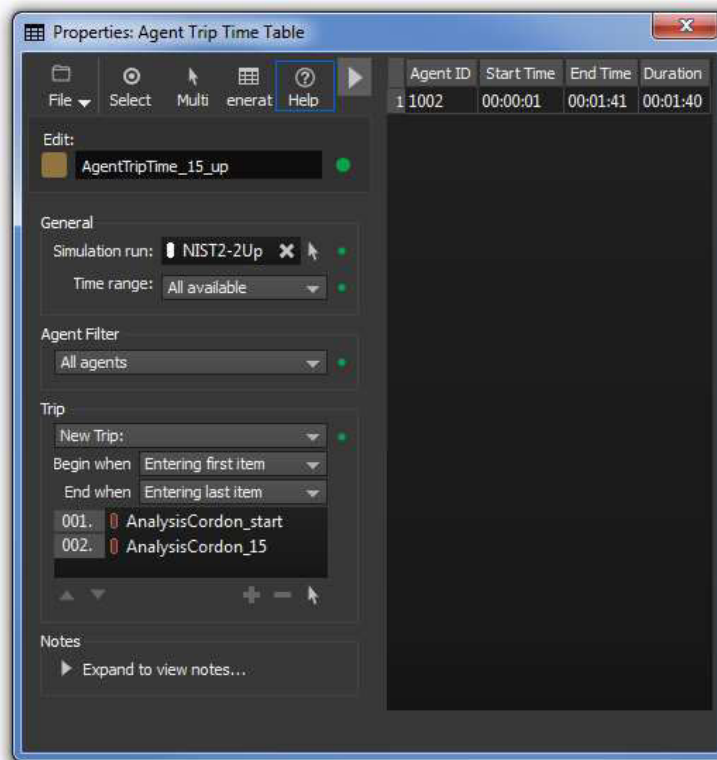

Figure A2.4: MassMotion Test 2 – 15.0° Ascending – Trip Time Table

Properties: Agent Trip Time Table

Agent ID	Start Time	End Time	Duration
11003	00:00:01	00:01:41	00:01:40

Edit: AgentTripTime_29-5_up

General

Simulation run: NIST2-2Up

Time range: All available

Agent Filter: All agents

Trip

New Trip:

Begin when: Entering first item

End when: Entering last item

001. AnalysisCordon_start

002. AnalysisCordon_29-5

Notes

Expand to view notes...

Figure A2.5: MassMotion Test 2 – 29.5° Ascending – Trip Time Table

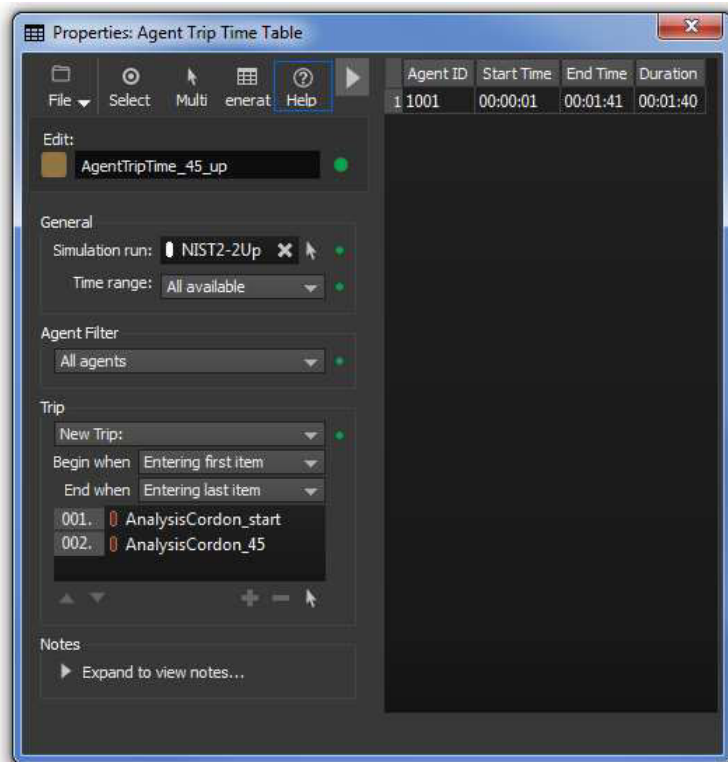

Figure A2.6: MassMotion Test 2 – 45.0° Ascending – Trip Time Table

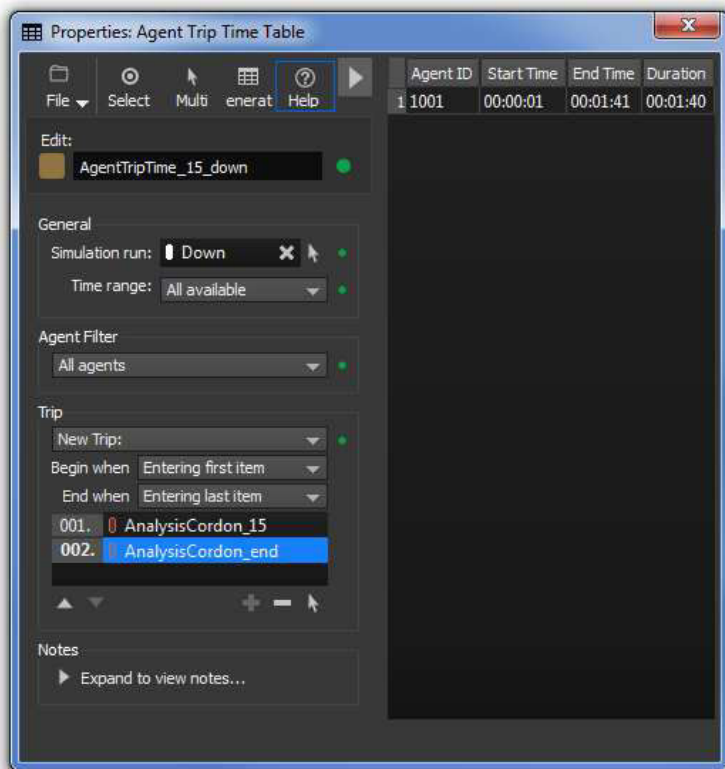

Figure A2.7: MassMotion Test 3 – 15.0° Ascending – Trip Time Table

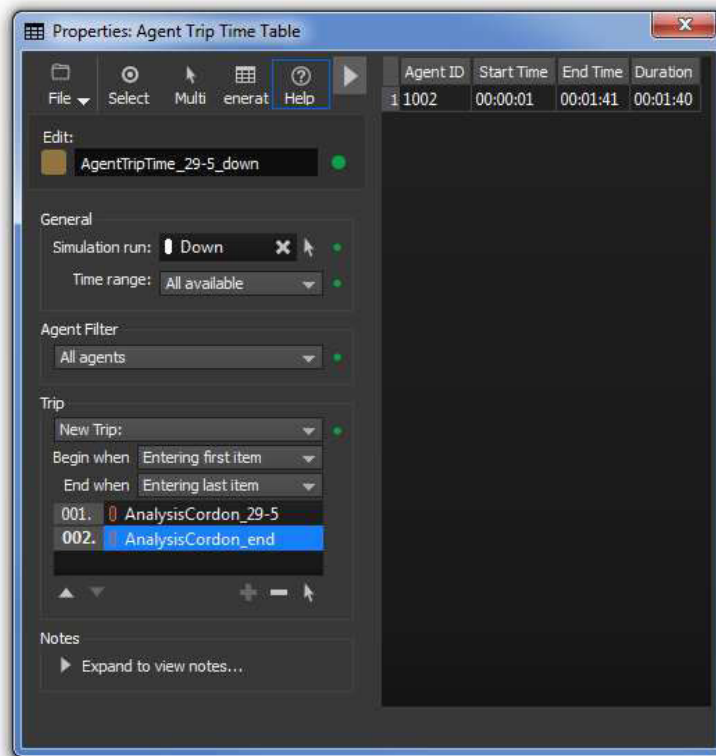

Figure A2.8: MassMotion Test 3 – 19.5° Ascending – Trip Time Table

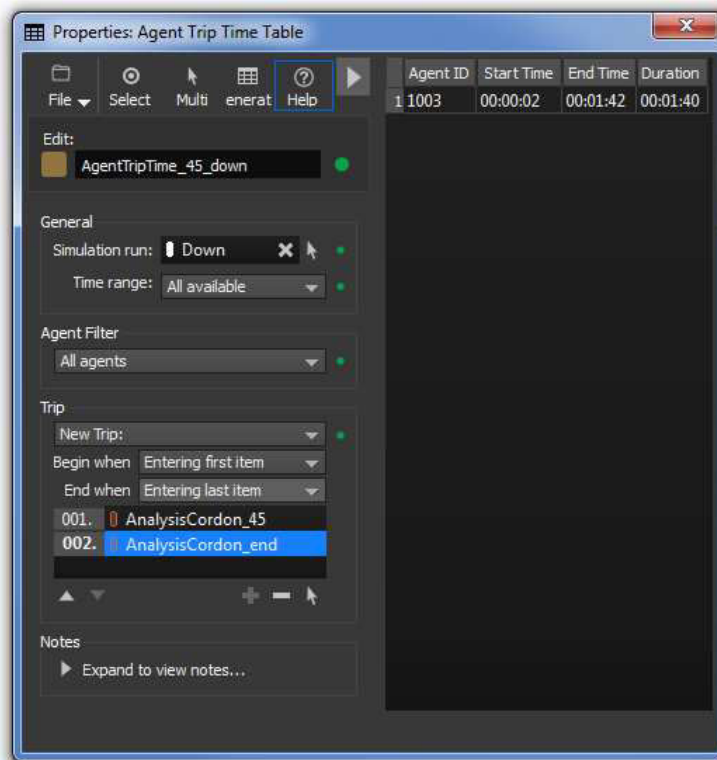

Figure A2.9: MassMotion Test 3 – 45.0° Ascending – Trip Time Table

A2.5 Conclusion

The NIST 1822 Test 2.2 has been conducted using MassMotion.

The predictions indicate that MassMotion is able to reproduce the results stated in the NIST guidance given the configured parameters of the model.

Status: Pass.

A3 Test 4: Exit Flow Rates

A3.1 Test Description

This test comprises of two parts:

Part 1: A test in accordance with IMO 1238 Test 4 and NIST 1822 Test 5.2 to verify that the flow rate of a link / door is capped at an assigned value. (1.33 people/m/s is adopted for this study.)

Part 2: A sensitivity study to determine the peak unrestricted (non-capped) flow rates of a link / door for a variety of widths (800mm, 900mm, 1000mm, 1100mm, 1200mm, 1400mm, and 1500mm) predicted by the MassMotion model.

A3.2 Aim of Tests

Part 1: The purpose of the test is to demonstrate that the capped flow rate at the link / door is not exceeded.

Part 2: The purpose of the test is to determine the sensitivity of the MassMotion model peak flow rate prediction as a function of link / door width.

A3.3 Simulation Setup

An 8m x 5m floor with a 1000mm link (located centrally on the 5m wall) to a smaller second floor was created.

An entry portal is located (remote from the link) within the larger floor. An exit portal is located (remote from the link) within the smaller floor.

A cordon line is located at the link.

The total room occupancy is 100 agents. The pre-evacuation time is set to 0 seconds, and the preferred travel speeds are the MassMotion default speeds (between 0.6m/s and 1.2m/s).

Part 1: The 1000mm link is defined to have a capped flow rate of 1.33people/s. (Figure A3.1.)

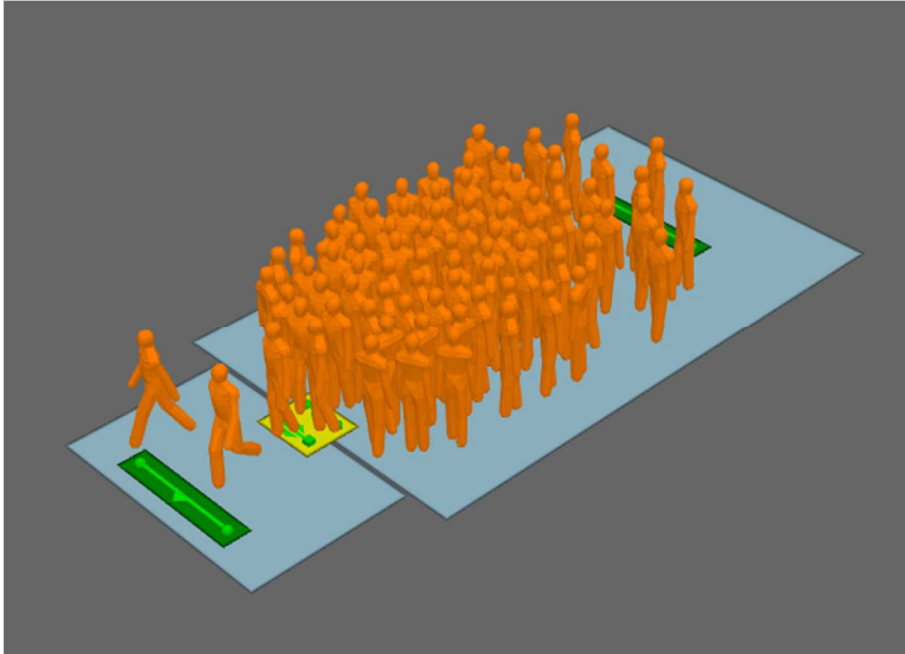

Figure A3.1: Physical Environment and Agent Occupancy

Part 2: The simulation setup is as for Part 1 apart from:

- the link flow rate is not capped;
- alternative link widths (800mm, 900mm, 1000mm, 1100mm, 1200mm, 1400mm, and 1500mm) are considered.

(Figure (A3.2.))

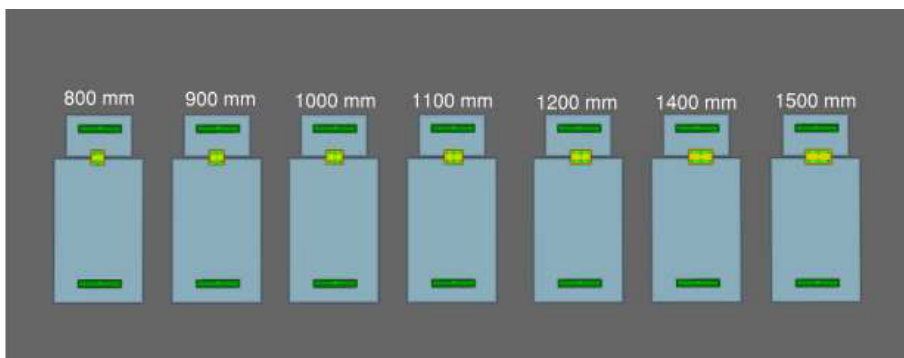

Figure A3.2: Part 2 Sensitivity Cases

A3.4 Test Results

Part 1: Figure A3.3 illustrates the time averaged flow rate at the link.

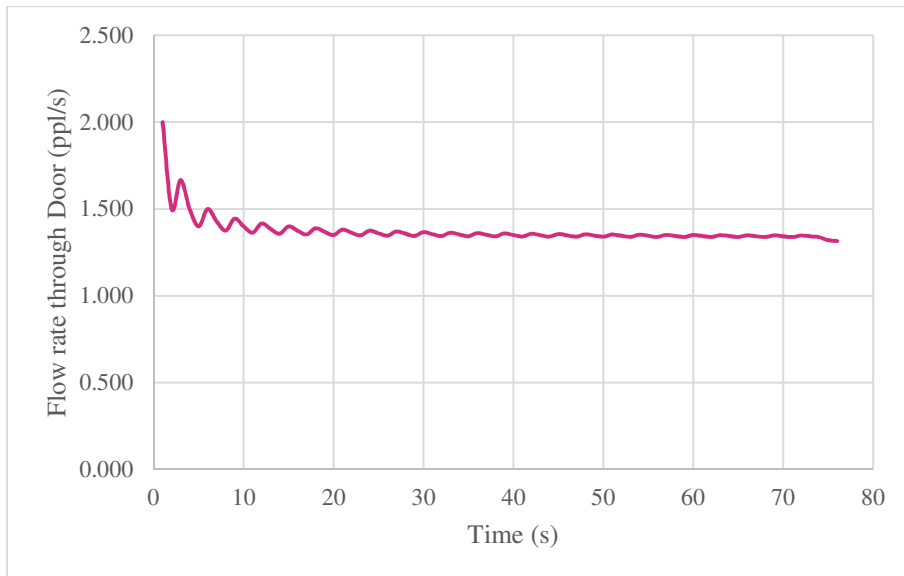

Figure A3.3: Flow Rate (People/s) Across the Link

The overall average flow rate (100 people / 76s exit time) is 1.315persons/s.

The mean value of the time averaged flow rates in the period from 20s to 76s is 1.348people/s, i.e. 101.4% of the value defined as the capped flow rate.

The time averaged flow rates in the period at the start of the simulation are predicted to be in excess of 1.33people/s. This is a function of the time averaging calculation rather than being caused by the underlying capping flow rate within MassMotion. (The capping flow rate model within MassMotion uses the prescribed capping flow rate to calculate a minimum time during which a second agent cannot use a link after the first agent has passed through it. For example: a capping flow rate of 1.33 agents/second translates into a minimum delay between agents using the link of 0.75seconds, i.e. there must be at least 0.75seconds between consecutive agents moving through the link. By way of illustration, assume that the first three agents pass through the link at 0.1s, 0.85s and 1.65s. (This is consistent with a capped flow rate of 1.33persons/s as there is a 0.75s delay between each agent passing through the link.) The time averaging calculation (as illustrated in Figure A3.3) is undertaken at one second intervals (starting at time 0 seconds). Then:

- at 1s, the time average is calculated to be 2persons/s (the first and second agents have passed through the link);
- at 2s, the time average is calculated to be 1.5people/s.)

Together, these predictions demonstrate that the flow rate is capped at 1.33persons/s (even though this appears not to be the case in Figure A3.3).

Part 2: Figures A3.4 and A3.5 illustrate the MassMotion predictions (including the time averaged flow rates across the link).

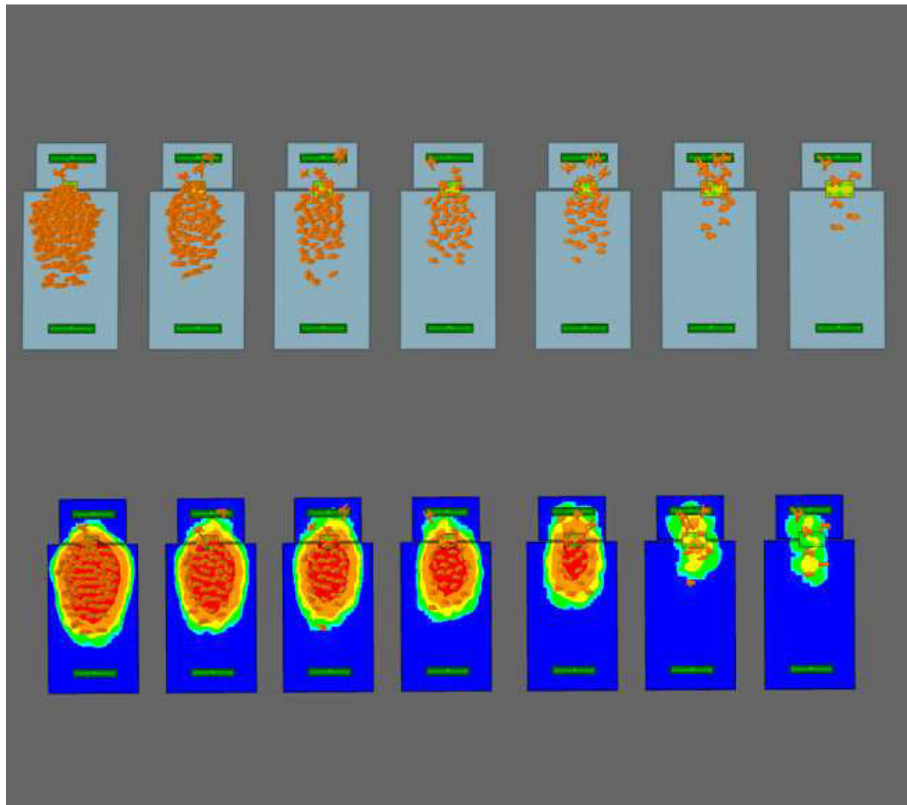

Figure A3.4: Part 2 – Agent Occupancy and Instantaneous Density 41s (for Each Case)

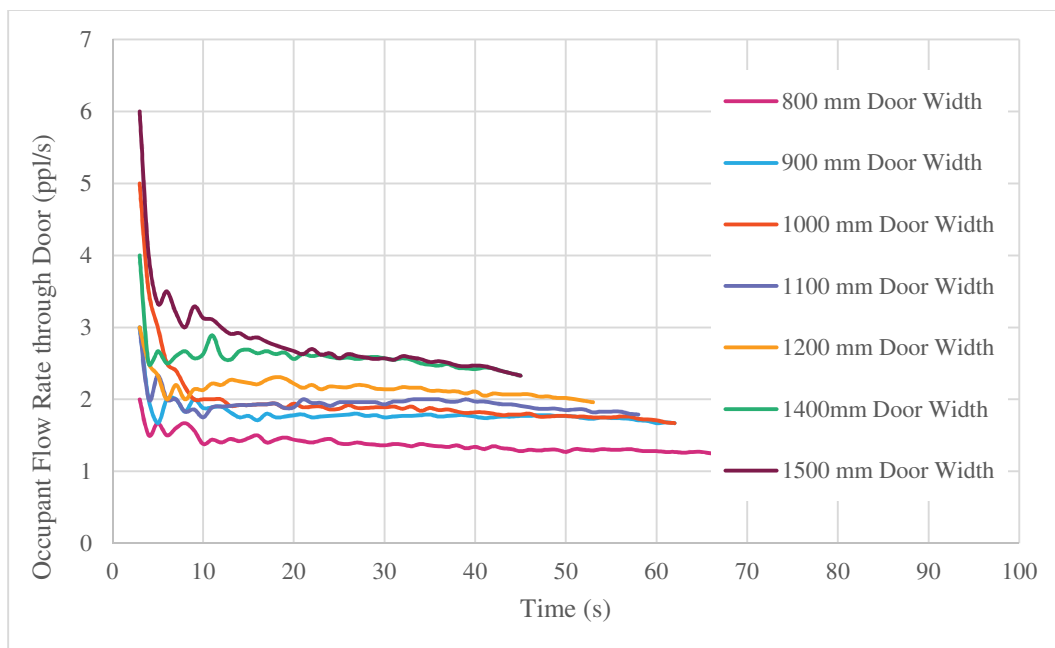

Figure A3.5: Flow Rate (People/s) Across the Link

The MassMotion predictions illustrated in Figure A3.5 follow the same trends as those observed in Figure A3.3 (including the flow rate averaging measurement calculation ‘spike’ previously described). The pre-evacuation time is represented appropriately, as the first person exits the room in the first second in each case.

Consideration of the time averaged flow rates during the ‘steady flow’ phase enables an approximate calculation of the average flow rate per unit of width (people/m/s) to be made for all cases. By way of ‘reverse engineering’, the average flow rate per unit of width is approximately 1.9people/m/s (See Table A3.1).

Door Width (mm)	Average Flow Rate per Unit Width* (people/m/s)	Expected Overall ‘Steady’ Flow Rate (people/s)	Modelled ‘Steady’ Flow Rate (people/s)
800	1.9	1.52	1.5**
900	1.9	1.71	1.7**
1000	1.9	1.90	1.9**
1100	1.9	2.09	2.0***
1200	1.9	2.28	2.3**
1400	1.9	2.66	2.6**
1500	1.9	2.85	2.65****
* Assumed. ** Estimated at 20s. *** Estimated at 20s – 30s (but note increase to 2.1s for long period after 30s). **** Doesn’t follow trend.			

Table A3.1: Average Flow Rate per Unit Width Estimates

Firstly, note that the average flow rate per unit of width of 1.9people/m/s is greater than values reported in other studies [17]. ([5][6] indicates that the maximum average flow rate per unit of width is 82people/m/min \approx 1.37people/m/s.).

The modelled ‘steady’ flow rate per unit width for the 1500mm door is 1.77people/m/s and, therefore, does not follow the trend of having an average flow rate per unit of width of 1.9people/m/s.

Considering the actual flow rates after the first 20s of each simulation (i.e. when the constant peak flow rates area achieved), the predicted flow rates follow the expected trend in that there is an increase in flow rate with the increase in link width. This relationship is examined in Table A3.2 and Figure A3.6.

Door Width (mm)	Comparison with 800mm Door	
	Increase in Width (%)	Increase in Flow Rate (%)
800	0.0%	0.0%
900	12.5%	35.0%
1000	25.0%	39.2%
1100	37.5%	49.0%
1200	50.0%	61.8%
1400	75.0%	92.6%
1500	87.5%	93.9%

Table A3.2: Increase in Uncapped Flow Rate with Increase in Link Width

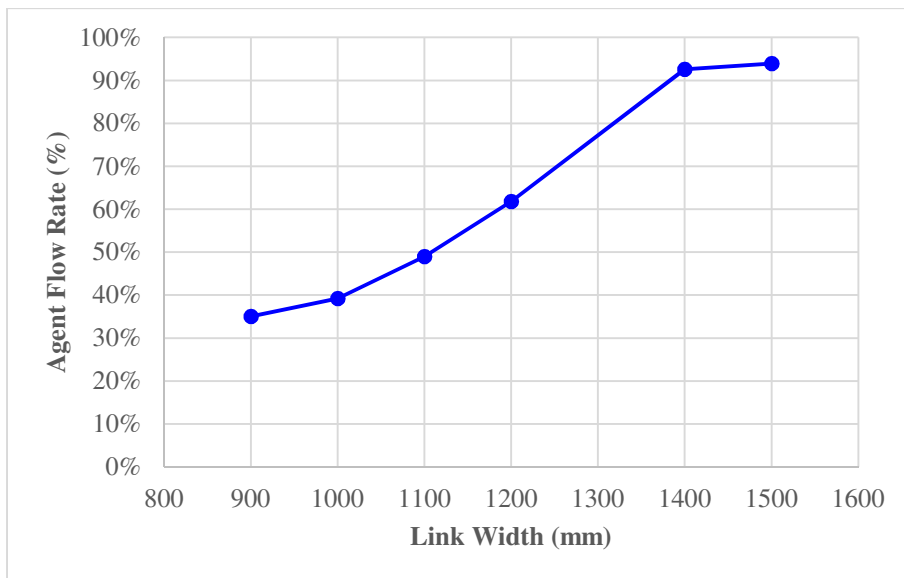

Figure A3.6: Increase in Uncapped Flow Rate with Increase in Link Width

From 1000mm to 1400mm the increase in uncapped flow rate is approximately linearly proportional to the increase in link width.

A3.5 Conclusion

The IMO 1238 Test 4 and NIST 1822 Test 5.2 have been conducted using MassMotion.

The predictions indicate that MassMotion is able to reproduce the results stated in the IMO and NIST guidance given the configured parameters of the model.

Status: Pass.

A4 Test 5: Pre-evacuation Time

A4.1 Test Description

The test is in accordance with IMO 1238 Test 5 and NIST 1822 Test 1.1.

Ten persons are located on a 8m x 5m floor having a 1.0 mm link (located centrally on the 5m wall). Pre-evacuation times are imposed randomly from a uniform probability distribution within a range from 10s to 100s.

The purpose of the test is to demonstrate that each occupant starts to move at the specified time.

The IMO 1238 and NIST 1822 tests are identical with the exception that the latter requiring that the default probability distribution types within the model to be tested.

A4.2 Aim of Test

This test considers the representation of the pre-evacuation time within the MassMotion evacuation model. The aim of the test is to verify that each occupant starts to move at the time specified and that the range of times for multiple agents are consistent with the distribution employed.

A4.3 Simulation Setup

The MassMotion 'evacuate' event automatically creates a 'Wait' action (i.e .pre-evacuation time) followed by 'Seek Portal' and 'Exit' actions.

It is currently not possible to output the pre-evacuation time for each agent directly from MassMotion. Instead, a 'Wait' action followed by an 'Exit' action (omitting the 'Seek Portal' action) is defined so that as soon as an agent finishes its pre-evacuation time it is removed from the model. This exit time is easily output from MassMotion and thus the wait time is documented. This same functionality is used for representing agent pre-evacuation times where agents are not removed from the model.

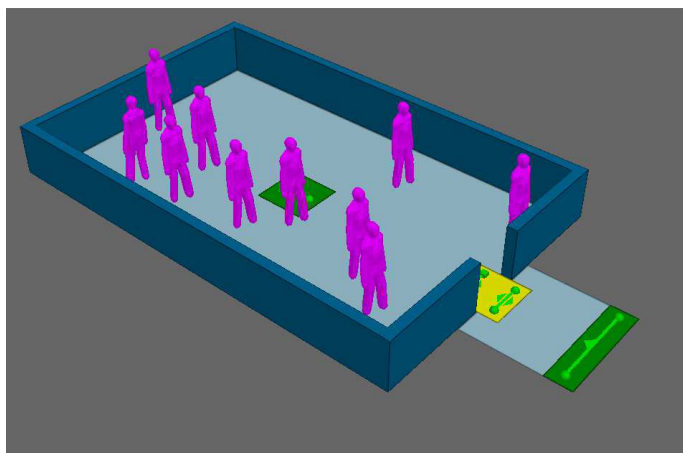

Figure A4.1: Physical Environment and Agent Occupancy

The action shown below in the graph was applied to all agents on spawning by their schedule for the IMO 5 and NIST 1.1 tests

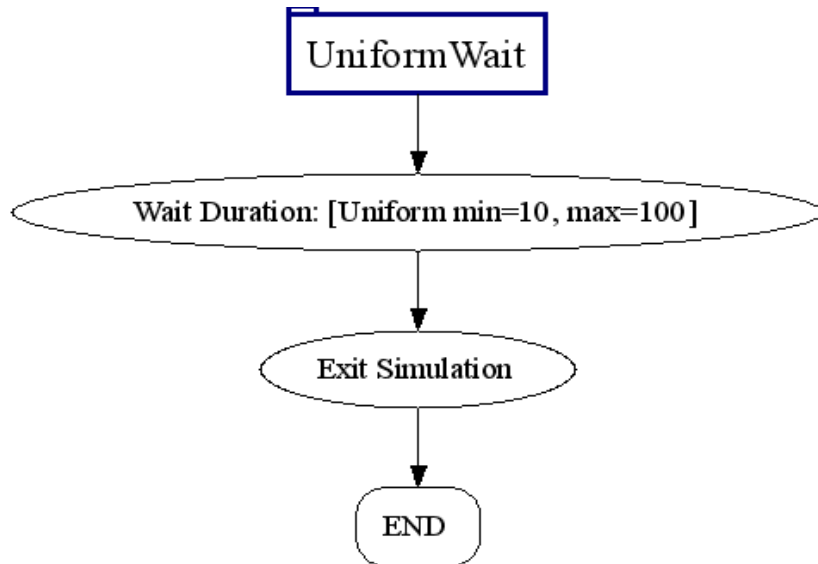

Figure A4.2: Uniform Distribution Parameters

The NIST test also requires any default pre-evacuation time distributions to be tested. These are described below for each type of distribution (note that MassMotion does not use default values for the distributions and, therefore, appropriate values have been selected for the verification tests).

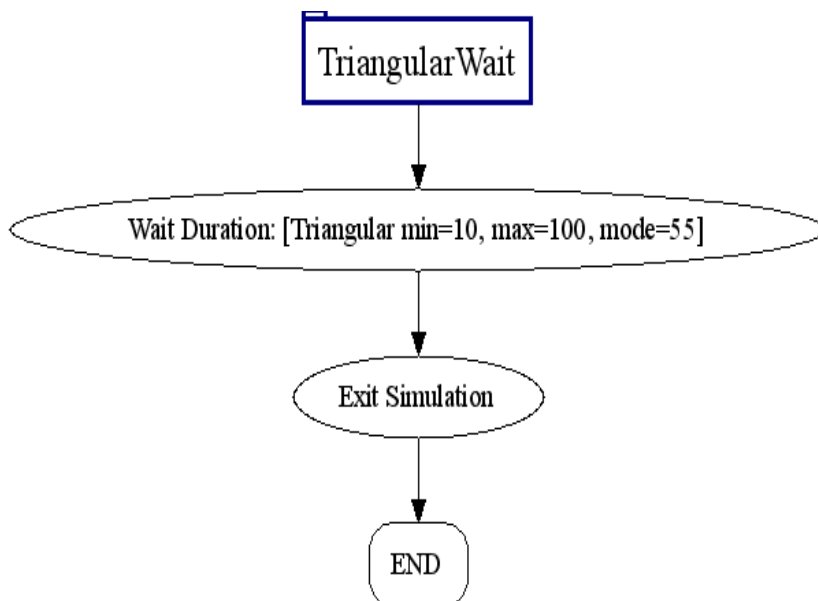

Figure A4.3: Triangular Distribution Parameters

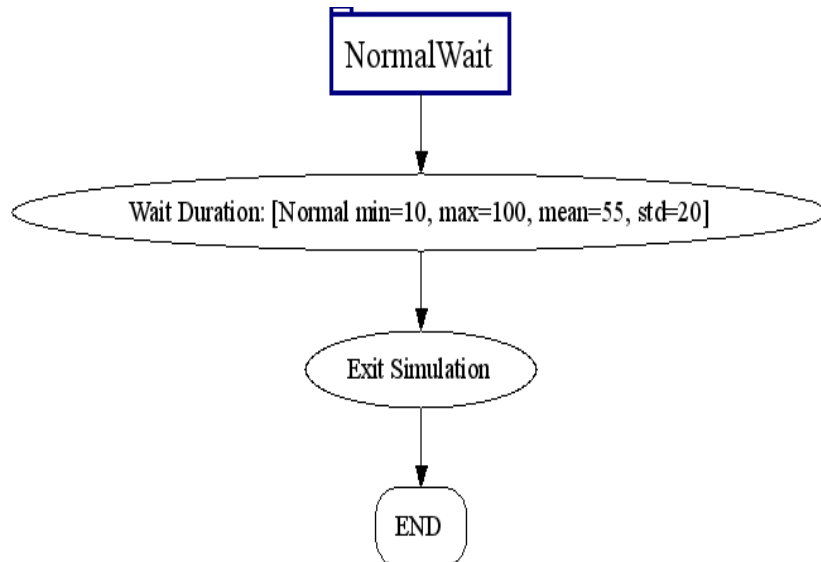

Figure A4.4: Normal Distribution Parameters

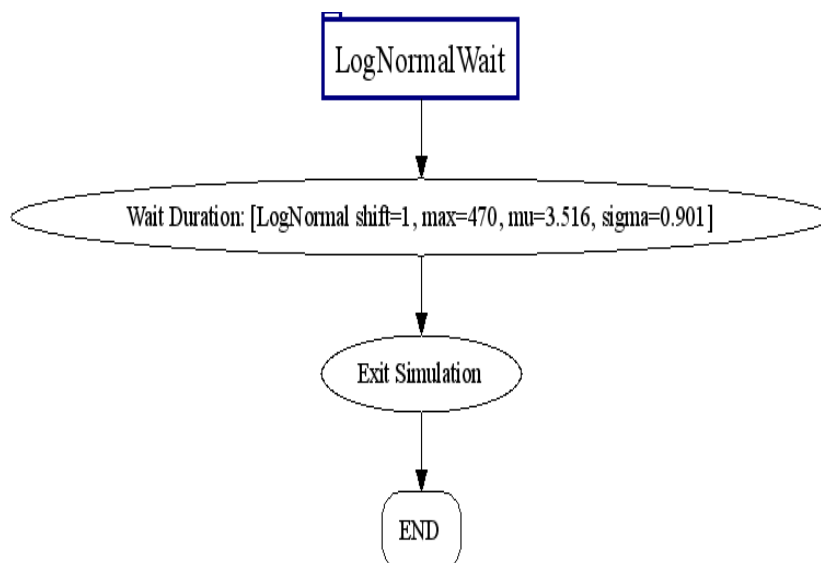

Figure A4.5: Log-normal Distribution Parameters

The schedule creates the 10 agents over the first five seconds of the simulation and the ‘Wait’ action applies from their entry time. Thus the measurement is not their exit time but rather their duration in the model. This information is given in the automatically created JourneyTimes.csv output file and, thus, is accessible for analysis.

50 simulation runs are generated (named “Batch1” to “Batch50”), each with a different random seed. An Excel VBA macro then opens each JourneyTimes.csv file and extracts the agents’

durations into a spreadsheet. The maximum, minimum, and average wait duration is then calculated from the 50 runs, i.e. for 500 agents.

A4.4 Test Results

For each distribution type, 50 simulations of 10 agents each generated a series of pre-evacuation times, shown as:

- summary data;
- histogram of pre-evacuation times (shown with a trendline);
- cumulative distribution of pre-evacuation times.

A4.4.1 Uniform Pre-evacuation Time Distribution

Summary pre-evacuation time results:

- minimum = 10.4s;
- maximum = 100.2s;
- average (mean) = 55.9s;
- standard deviation = 20.8s.

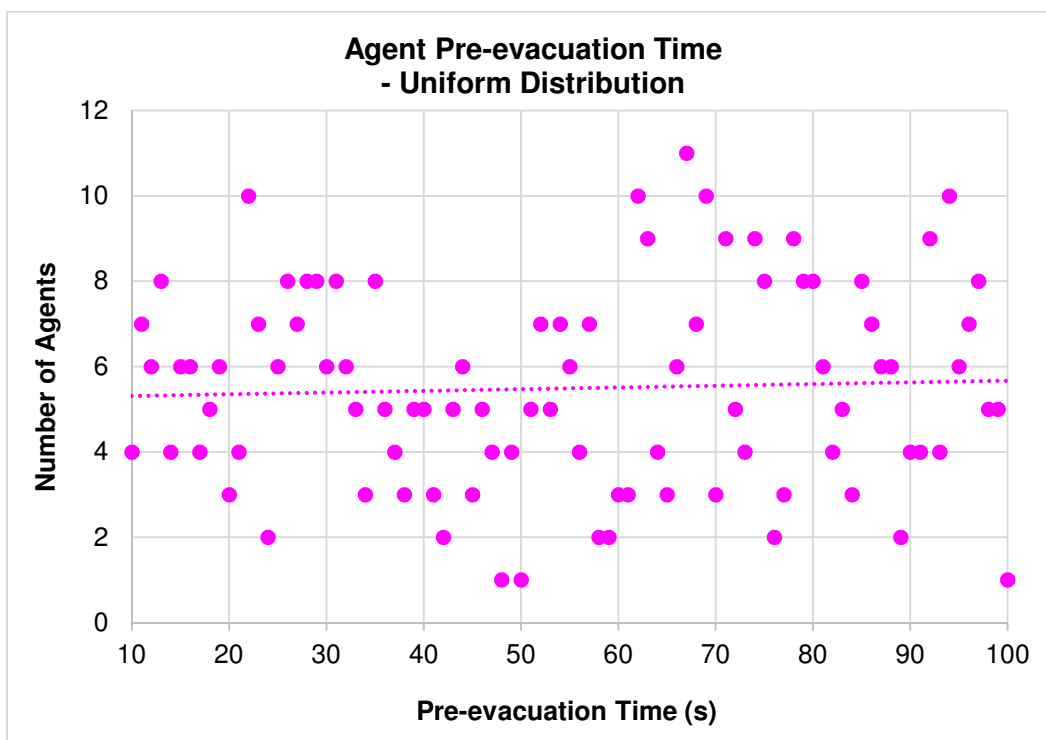

Figure A4.6: Uniform Distribution – Histogram of Agent Pre-evacuation Times

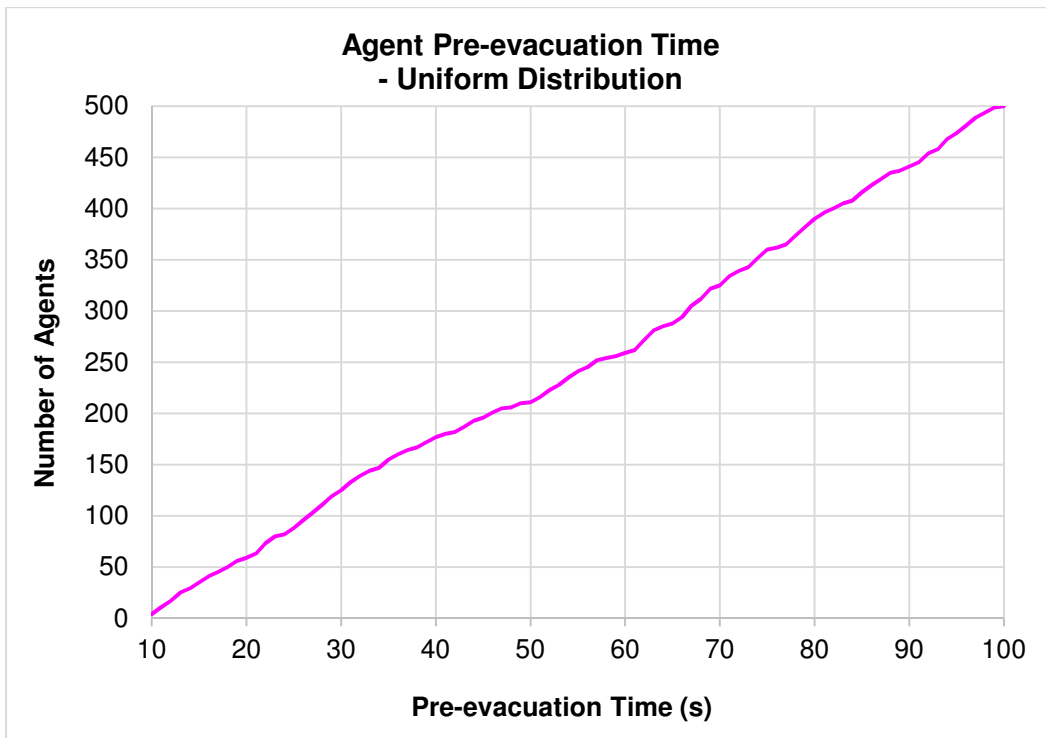

Figure A4.7: Uniform Distribution – Cumulative Distribution of Agent Pre-evacuation Times

A4.4.2 Triangular Pre-evacuation Time Distribution

Summary pre-evacuation time results:

- minimum = 10.6s;
- maximum = 96.0s;
- average (mean) = 54.1s;
- standard deviation = 13.2s.

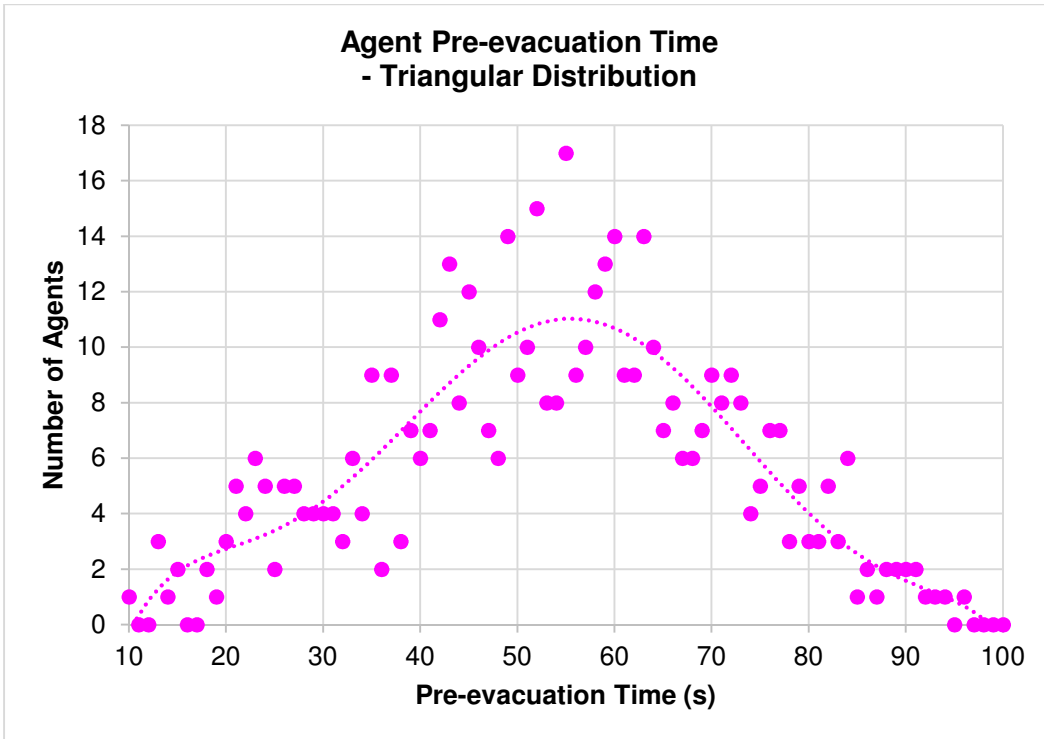

Figure A4.8: Triangular Distribution – Histogram of Agent Pre-evacuation Times

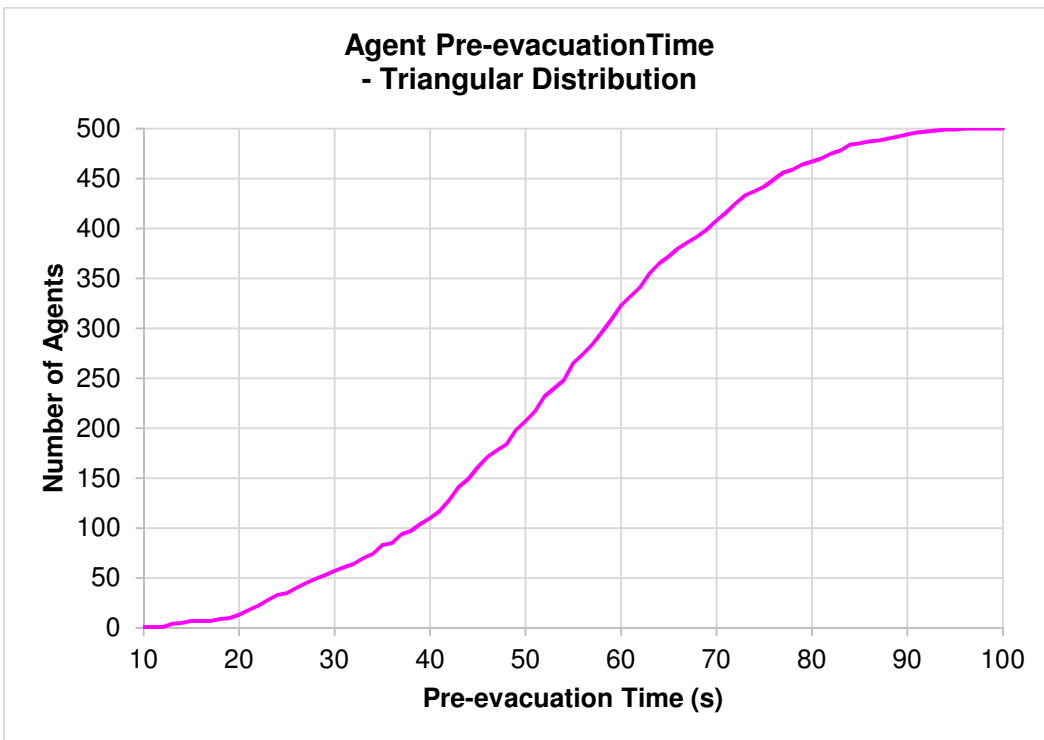

Figure A4.9: Triangular Distribution – Cumulative Distribution of Agent Pre-evacuation Times

A4.4.3 Normal Pre-evacuation Time Distribution

Summary pre-evacuation time results:

- minimum = 11.2s;
- maximum = 100.0s;
- average (mean) = 56.6s;
- standard deviation = 14.7s.

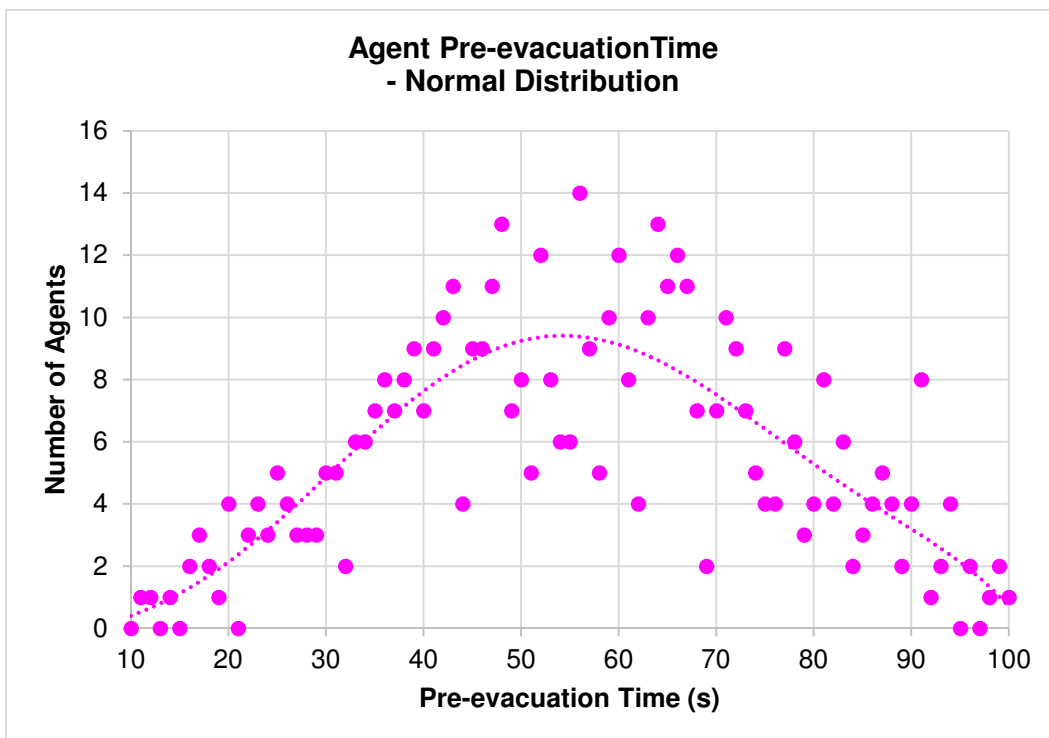

Figure A4.10: Normal Distribution – Histogram of Agent Pre-evacuation Times

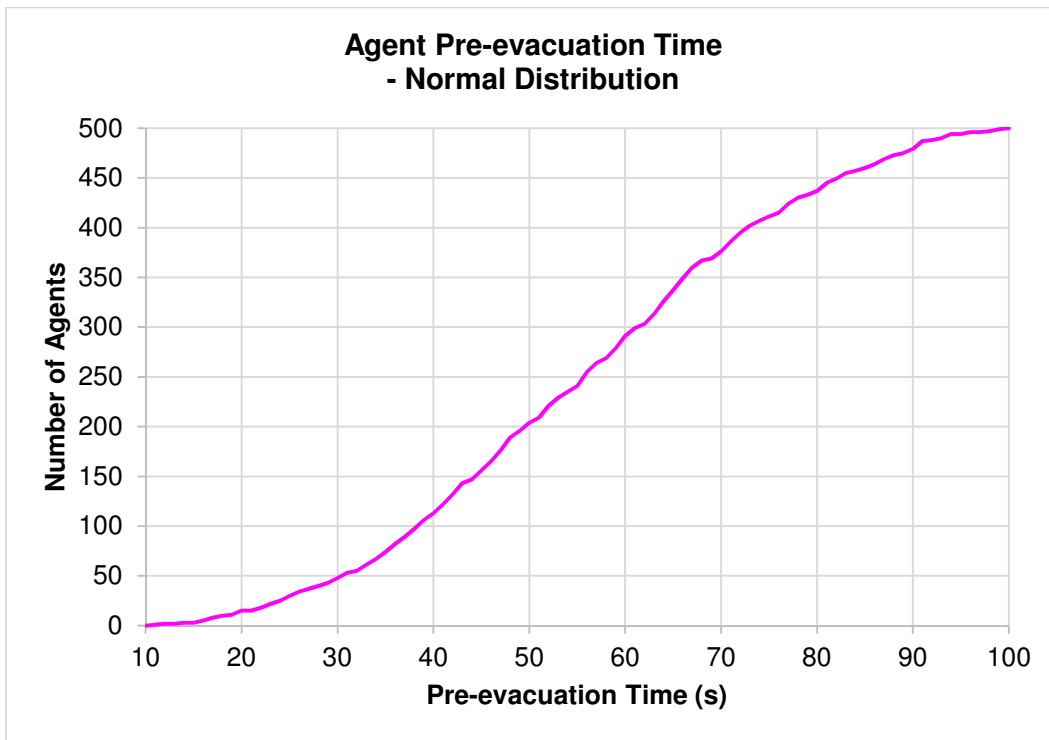

Figure A4.11: Normal Distribution – Cumulative Distribution of Agent Pre-evacuation Times

A4.4.4 Log-normal Pre-evacuation Time Distribution

Summary pre-evacuation time results:

- minimum = 3.2s;
- maximum = 465.2s;
- average (mean) = 56.4s;
- standard deviation = 63.0s.

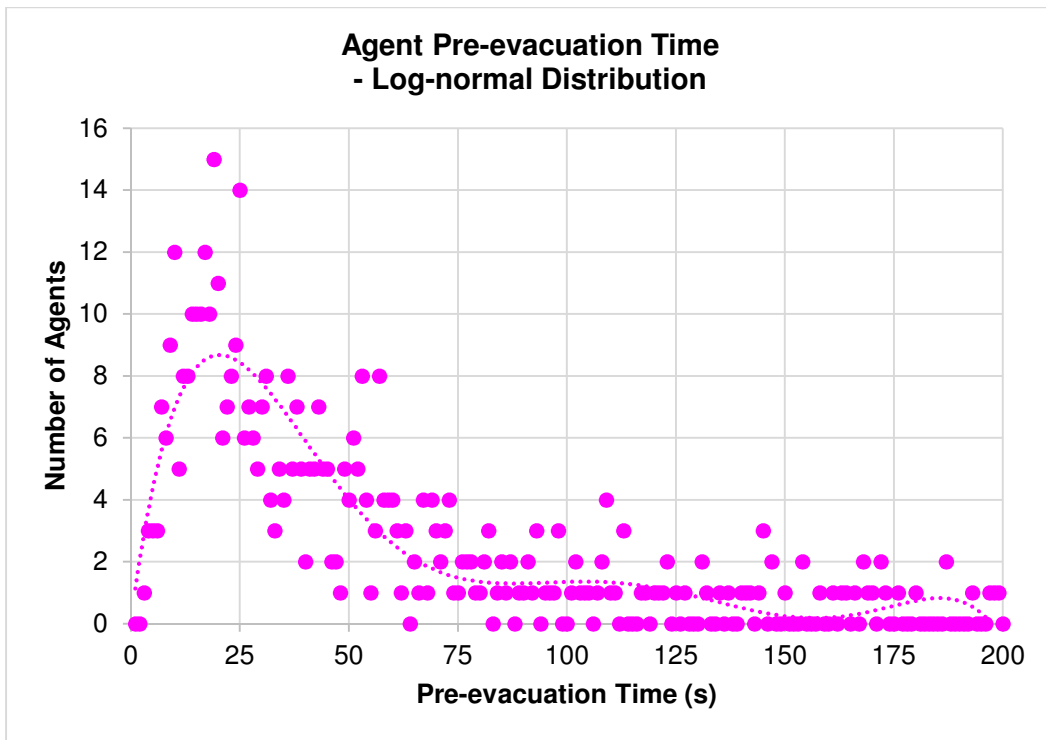

Figure A4.12: Log-normal Distribution – Histogram of Agent Pre-evacuation Times

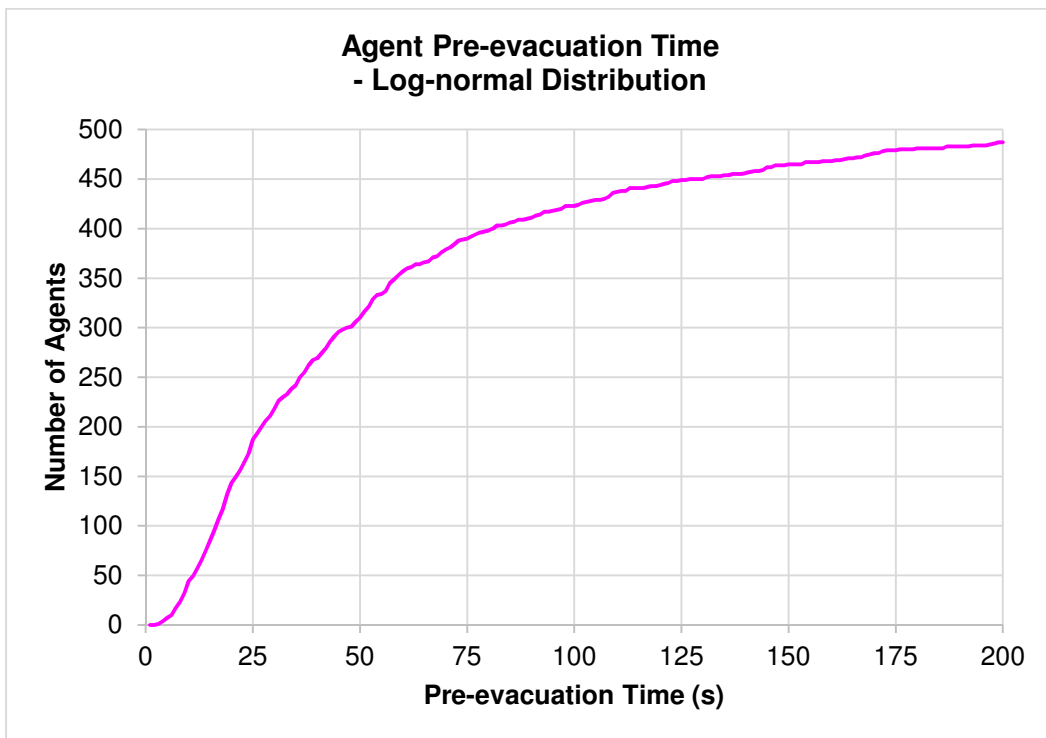

Figure A4.13: Log-normal Distribution – Cumulative Distribution of Agent Pre-evacuation Times

A4.5 Conclusion

The IMO 1238 Verification Test 5 and NIST Verification test 1.1 has been conducted in the MassMotion evacuation model. Results from the test indicate MassMotion is able to produce comparable results to those stated in the IMO and NIST guidance given the configured parameters of the model.

Status: Pass.

A5 Test 6: Movement Around Corners

A5.1 Test Description

The test is in accordance with IMO 1238 Test 6 and NIST 1822 Test 2.3.

The test is based on a right angle corridor having dimension as illustrated in Figure A5.1.

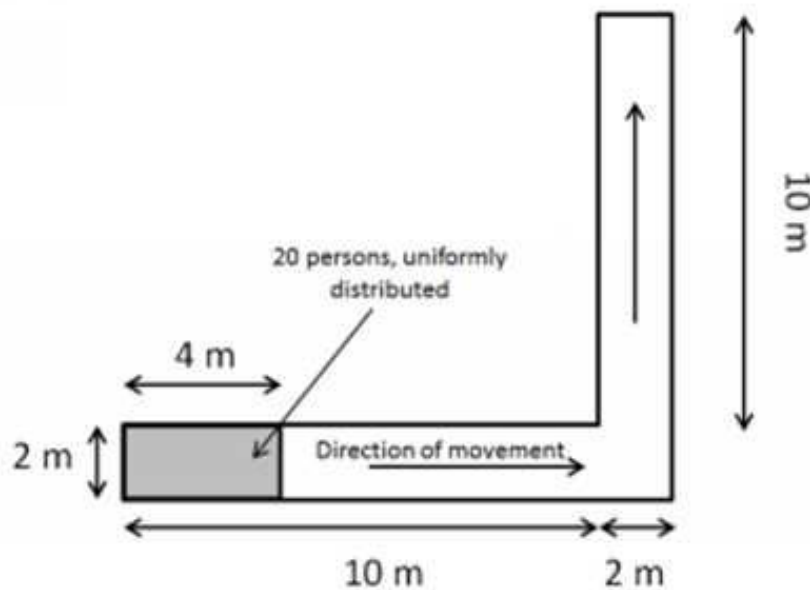

Figure A5.1: Geometric Layout

Twenty persons, uniformly distributed and having immediate pre-evacuation times and a preferred horizontal terrain walking speed of 1 m/s, occupy one end of the corridor.

The test is a qualitative verification of the agent movement, performed by observing the agent travel path.

A5.2 Aim of Test

The purpose of the test is to verify that the twenty agents approach the corner and successfully navigate around it without penetrating the boundaries of the physical environment.

A5.3 Simulation Setup

The geometrical layout of the IMO 1238 Test 6 and NIST 1822 Test 2.3 are identical.

A single geometry floor area was created, consisting of a 2 m x 4 m area appended to a 2 m x 8 m area and a 2 m x 10 m area at a 90° angle to the first floor (as Figure A5.1).

An entry portal was assigned to the 2 m x 4 m floor.

An exit portal was created at the end of the corridor remote from the entry portal.

An agent profile with constant preferred horizontal walking speed of 1m/s and having no direction bias was created.

A population of 20 agents (with the agent profile described) was uniformly distributed across the 2m x 4m area within the first 1s of the simulation.

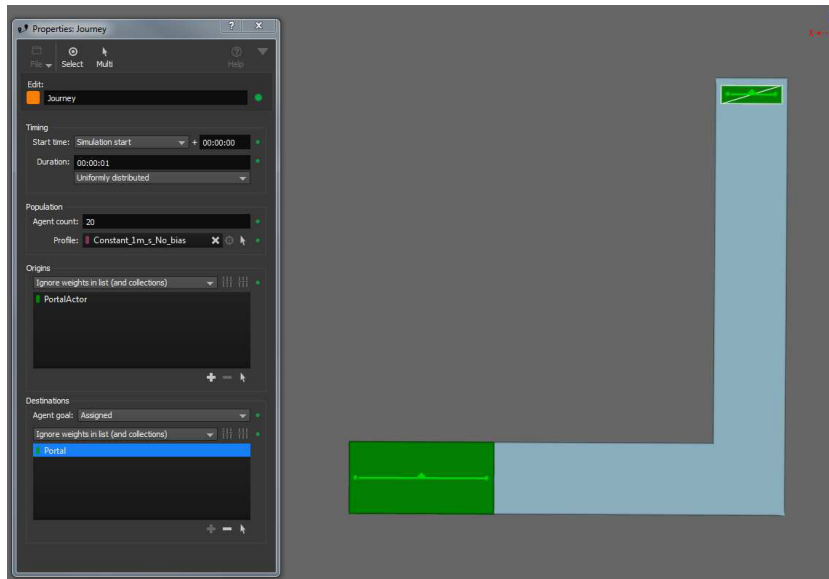
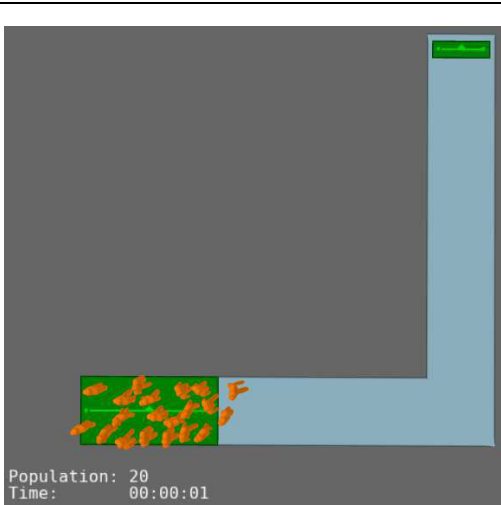

Figure A5.2: MassMotion Physical Environment and 'Journey' Properties

A5.4 Test Results

Figure A5.3 illustrate the simulated agent journeys at key times during the simulation.



Time: 1 Second – All 20 agents have entered the simulation and are distributed within the 2m x 4m floor allocated to the entry portal.

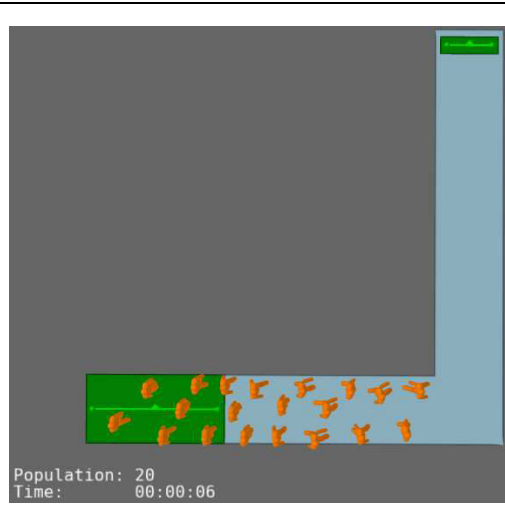

Time: 6 Seconds – Agents begin their journey toward the corridor corner at a desired walking speed of 1m/s. The first agent reaches the corner at this time (approximately).

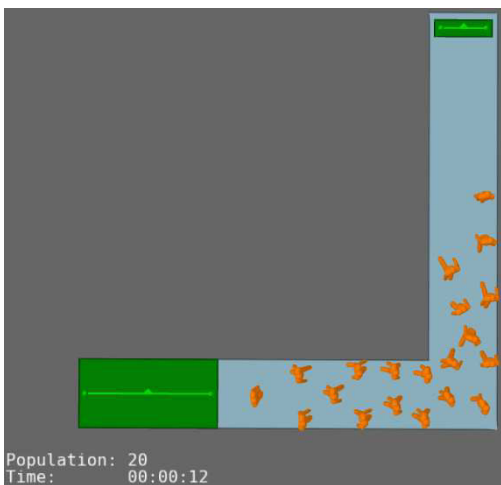

Time: 12 Seconds – Approximately 50% of the agent population have navigated the corner successfully. The corner is slightly congested as agents navigate this area.

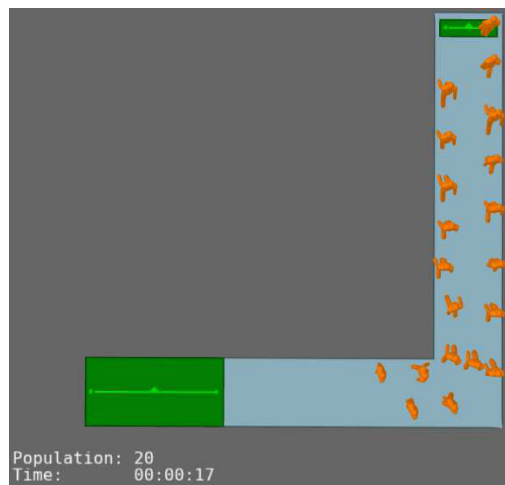

Time: 17 Seconds – The first agent has reached the destination portal. Two distinct and ordered lines have formed on exiting the corner.

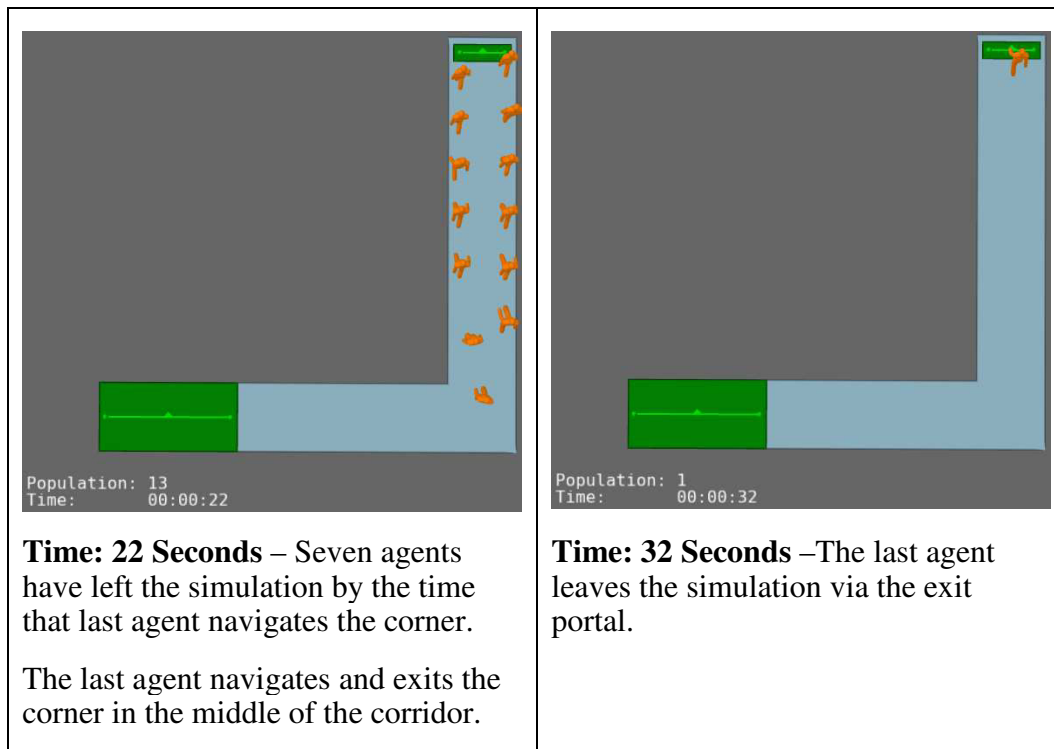

Figure A5.3: MassMotion Agent Journeys

The predicted agent path map (from the entry portal to the exit portal for each of the 20 agents) is illustrated in Figure A5.4 together with the agent co-ordinate positions.

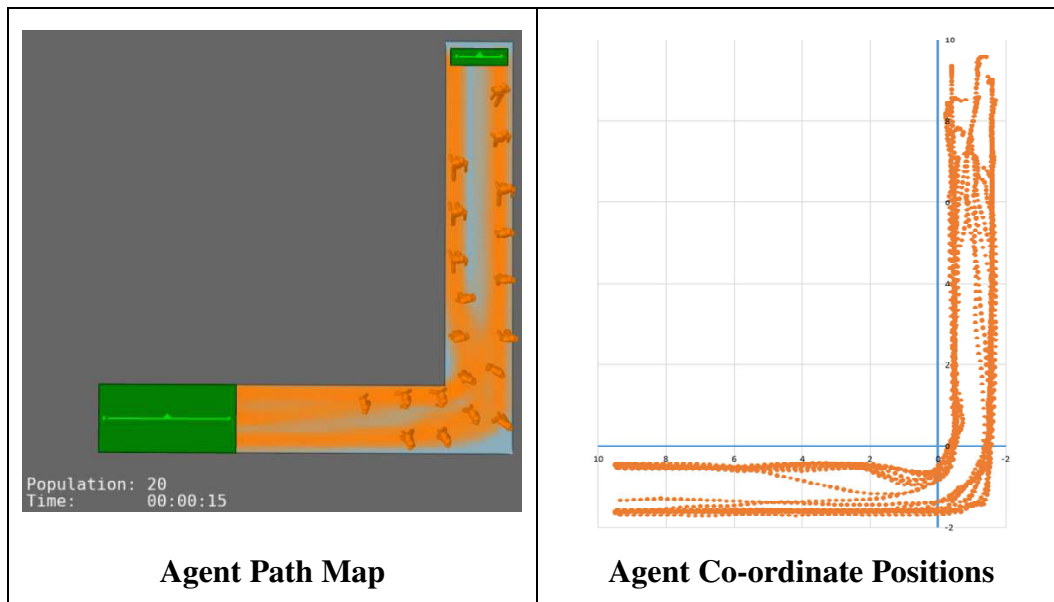

Figure A5.4: MassMotion Agent Path Maps and Co-ordinate Positions

These demonstrate that:

- the agents navigate the corner within the designated boundaries;
- there are two distinct agent paths (particularly after the corner).

Note – MassMotion undertakes the simulation within a 2-dimensional model. The MassMotion display shows 3-dimensional avatars overlaid onto the 2-dimensional model. As such, certain parts (e.g. arms) of the 3-dimensional avatar may appear to pass beyond the boundary of the physical environment. The agent co-ordinate positions of Figure A5.4 clearly demonstrate that this is a function of the visualisation process only.

Table A5.1 presents the quantified results from the MassMotion predictions.

Agent Performance					
ID	Entry Time (hh:mm:ss)	Exit Time (hh:mm:ss)	Duration (s)	Congestion Duration (s)	Distance Travelled (m)
1005	00:00:00	00:00:17	17.2	0.2	16.628
1019	00:00:00	00:00:18	17.8	0.2	16.793
1010	00:00:00	00:00:19	19.0	2.4	16.911
1014	00:00:00	00:00:19	19.6	3.4	18.112
1016	00:00:00	00:00:20	20.0	0.6	17.681
1003	00:00:00	00:00:21	21.4	3.8	17.657
1004	00:00:00	00:00:21	22.0	4.8	18.124
1012	00:00:00	00:00:22	22.6	6.6	18.805
1001	00:00:00	00:00:23	23.2	6.2	18.332
1018	00:00:00	00:00:24	23.4	6.6	19.257
1006	00:00:00	00:00:24	24.4	6.4	18.414
1007	00:00:00	00:00:25	25.4	10.0	19.137
1013	00:00:00	00:00:25	25.4	14.4	19.199
1017	00:00:00	00:00:26	26.2	15.8	18.873
1020	00:00:00	00:00:27	26.4	16.2	18.932
1002	00:00:00	00:00:28	28.6	13.4	20.470
1009	00:00:00	00:00:28	28.8	18.6	19.517
1015	00:00:00	00:00:30	29.8	20.4	20.187
1011	00:00:00	00:00:30	30.8	21.0	20.171
1008	00:00:00	00:00:32	32.6	23.0	20.712

Table A5.1: MassMotion Predictions of Agent Performance

All agents entered the simulations at 0s.

The first agent exits the simulation at 17.2s (with 0.2s congestion duration), having travelled a total distance of 16.63m. The average travel speed is $(16.63 / (17.2 - 0.2)) = 0.978\text{m/s}$. (Compared to the preferred horizontal terrain walking speed of 1m/s.)

The last agent exits the simulation at 32.6s (with 23.0s congestion duration) and having travelled 20.712m.

A5.5 Conclusion

IMO 1238 Verification Test 6 and NIST 1822 Test 2.3 have been conducted within MassMotion.

Analysis of the test results indicated that all 20 agents navigated the corner geometry without penetrating the boundaries.

The predictions indicate that MassMotion is able to reproduce the results stated in the IMO and NIST guidance given the configured parameters of the model.

Status: Pass.

A6 Test 7: Assignment of Parameters

A6.1 Test description

The test is in accordance with IMO 1238 Test 7 and NIST 1822 Test 2.4.

The test assigns a preferred horizontal terrain walking speed to a population of 100 agents. The preferred horizontal terrain walking speeds are selected at random from a uniform probability distribution (ranging from 0.97m/s to 1.62m/s – see IMO 1238 population panel ‘Males 30-50’). The aim is to confirm that the assigned preferred horizontal terrain walking speed is consistent with the uniform probability distribution.

A6.2 Aim of Test

The purpose of the test is to demonstrate that MassMotion is able to correctly assign agent demographic parameters (including the preferred horizontal terrain walking speed).

A6.3 Simulation Setup

The physical environment consists of:

- a 10m x 10m floor with an entry portal;
- a adjacent (3.7m x 3.2m) floor with an exit portal;
- a link (1.5m x 0.8m) connecting both floors.

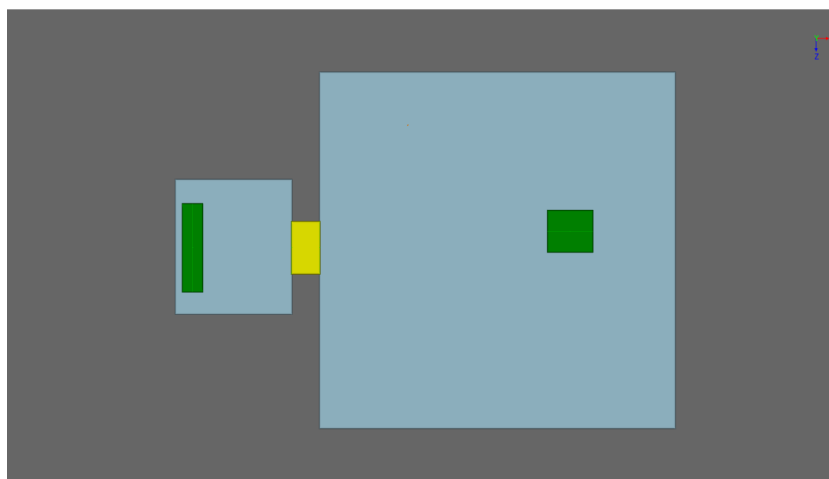

Figure A6.1: Physical Environment

An IMO 1238 ‘Males 30-50’ agent profile was created (Figure A6.2).

A ‘Journey’ event, with a population of 100 agents, was created (Figure A6.3).

A batch analysis of 50 runs was created (Figure A6.2 Figure A6.4).

All other parameters not identified above were assigned the MassMotion default values.

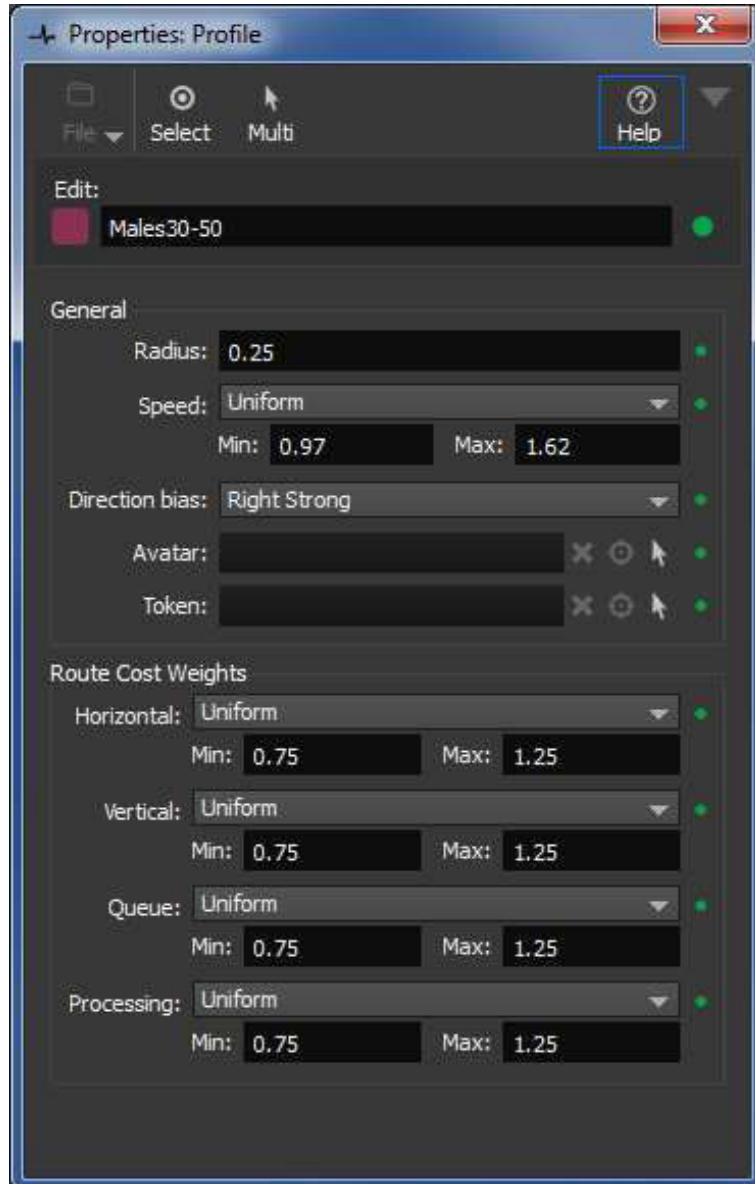

Figure A6.2: Agent Profile

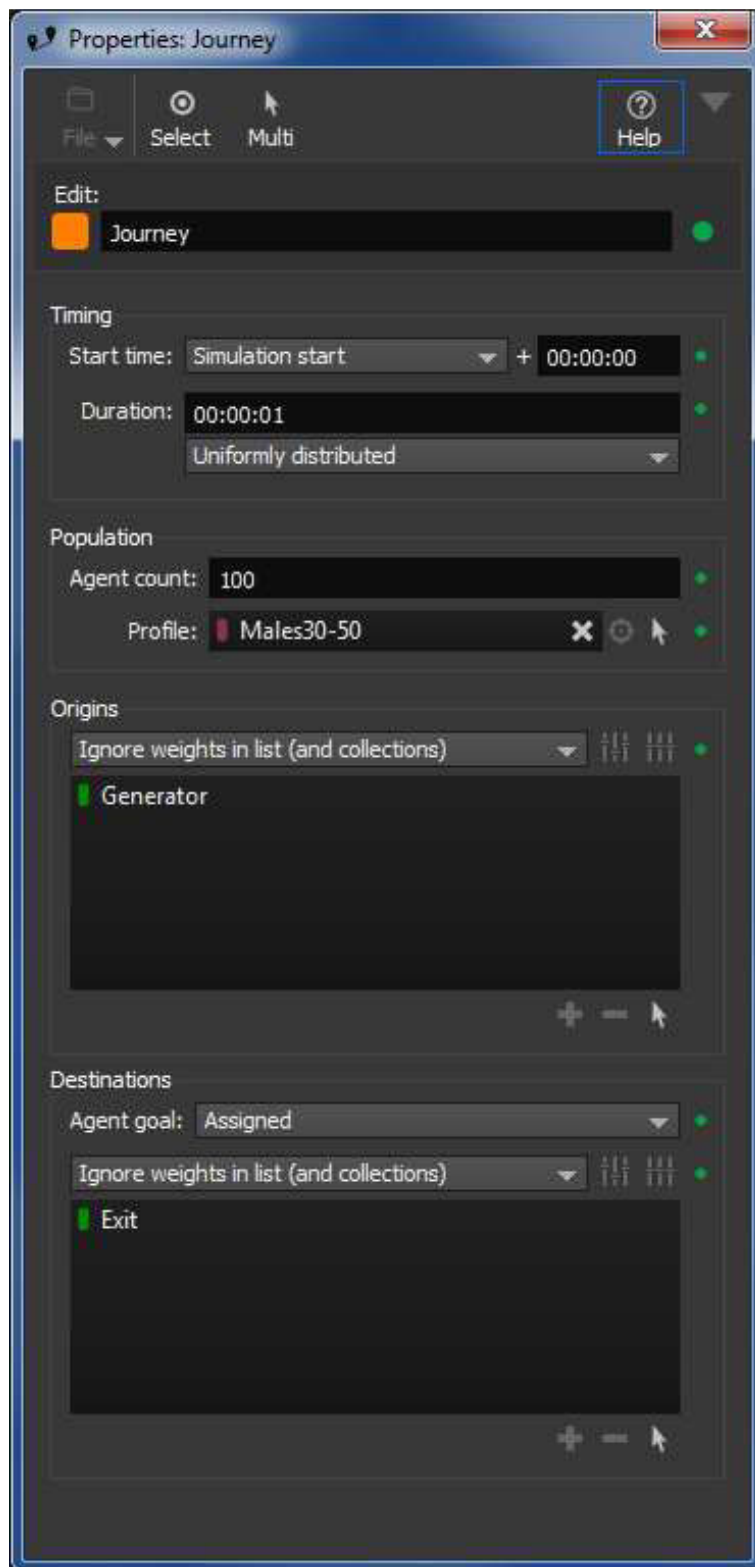

Figure A6.3: Journey Event

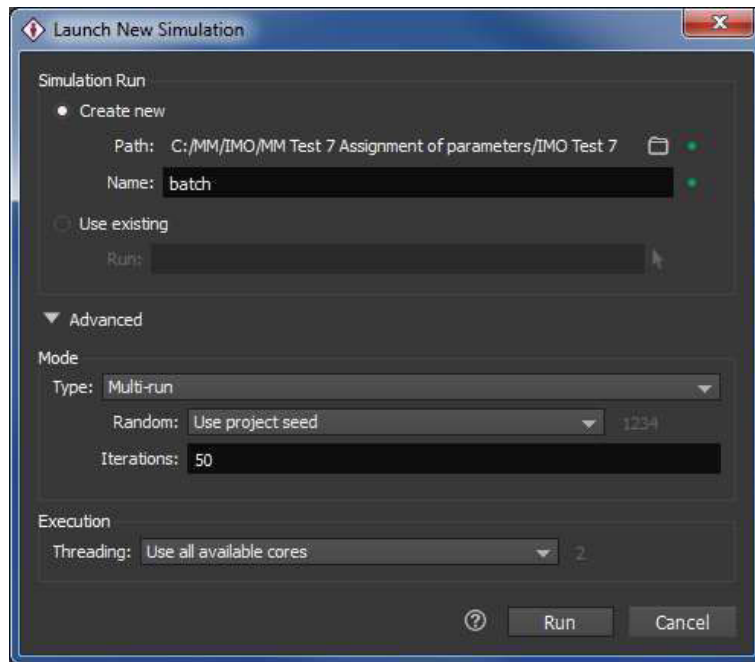

Figure A6.4: MassMotion Batch Simulation Run

A6.4 Test Results

50 simulation runs, each generating 100 agents, with 5000 agents in total.

The minimum, maximum, and mean preferred horizontal terrain walking speed of the agents is summarised In Table A6.1.

Preferred Horizontal Terrain Walking Speed (m/s)		
	Desired	Assigned
Minimum	0.97	0.970
Maximum	1.62	1.620
Mean	1.295	1.295

Table A6.1: Preferred Horizontal Terrain Walking Speed

Figure A6.5 illustrates the number of agents assigned preferred horizontal terrain walking speeds within 0.1m/s intervals across the range from 10s to 100s.

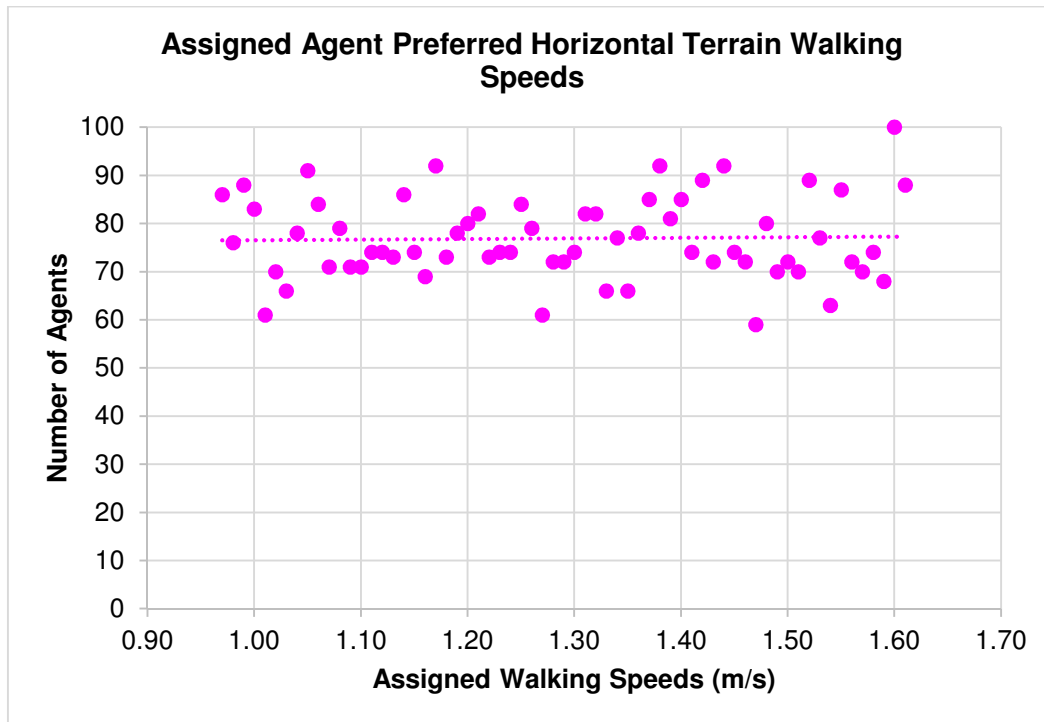

Figure A6.5: MassMotion Assigned Preferred Horizontal Terrain Walking Speeds

The trendline illustrates that the assigned distribution follows a uniform distribution.

A6.5 Conclusion

IMO 1238 Test 9 and NIST 1822 Test 2.4 have been conducted within MassMotion.

The predictions indicate that MassMotion is able to reproduce the results stated in the IMO and NIST guidance given the configured parameters of the model.

Status: Pass.

A7 Test 8: Counter-flow

A7.1 Test Description

The test is in accordance with IMO 1238 Test 8 and NIST 1822 Test 2.8.

Two 10m x 10m floors are connected via a 10m x 2m floor (corridor) connected to the centre of one side of each floor at the mid-points of one of its boundaries.

The test assigns a preferred horizontal terrain walking speed to a population of 100 agents. The preferred horizontal terrain walking speeds are selected at random from a uniform probability distribution (ranging from 0.97m/s to 1.62m/s – see IMO 1238 population panel ‘Males 30-50’). The agents are located at a preferred density of 4persons/m² at the side of the floor of one of the rooms remote from the corridor.

Scenario 1 requires the agents to pass through the corridor to an exit from the second floor remote from the corridor, as illustrated in Figure A7.1.

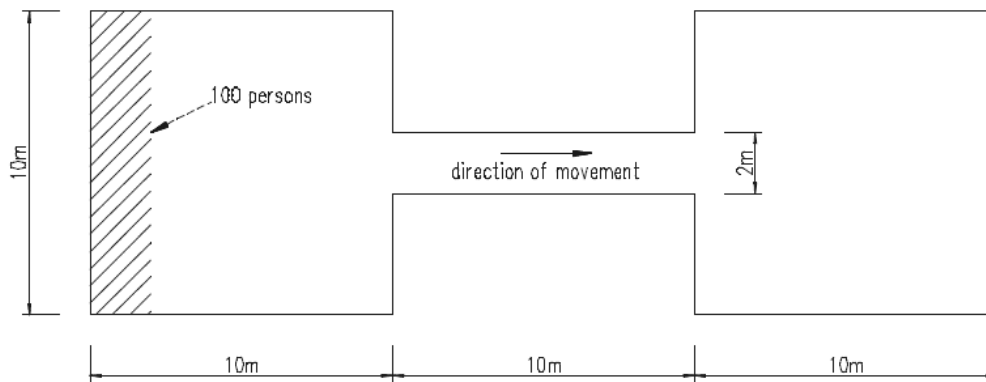

Figure A7.1: Geometric Layout – Scenario 1

Six further scenarios, summarised in Table A7.1, are considered. These scenarios test the sensitivity of the predictions with respect to the floor occupancy and the direction bias (side preference and strength).

Scenario				
ID	Floor Occupancy (persons)		Direction Bias	
	Left	Right	Preference	Strength
1	100 (Males)	0	Right	Strong
2	100 (Males)	10 (Males)	Right	Strong
3	100 (Males)	50 (Males)	Right	Strong
4	100 (Males)	100 (Males)	Right	Strong
5	100 (Males)	100 (Females)	Right	Strong
6	100 (Males)	100 (Males)	Right	Weak
7	100 (Males)	100 (Males)	None	Not Applicable

Table A7.1: Test Scenarios

The aim of the test is to investigate the effect of counter-flow within MassMotion.

A7.2 Aim of Test

The purpose of the test verify the ability of MassMotion to simulate counter-flow and its possible impact on evacuation time.

A7.3 Simulation Setup

Two 10m x 10m floors are connected via a 10m x 2m floor (corridor) connected to the centre of one side of each floor at the mid-points of one of its boundaries.

2000mm links connect the corridor to the floors at each end.

An entry portal is used to fill a 2.5m x 10m region of the left floor with 100 persons at a density of 4persons/m². (A similar entry portal is created at the corresponding location of the right floor in later scenarios.)

An exit portal is created at the extreme right boundary of the right floor. (A similar exit portal is created at the corresponding location of the left floor in later scenarios.)

Counter lines are created at the ends of the corridor.

The preferred horizontal terrain walking speeds is derived from the IMO 1238 guidelines (based on random assignment from a uniform probability distribution within the minimum and maximum speeds for the relevant population group, as defined in Table A7.2).

Group	IMO 1238 Population	Preferred Horizontal Terrain Walking Speed (m/s)	
		Minimum	Maximum
Females	Females 30-50	0.71	1.19
Males	Males 30-50	0.97	1.62

Table A7.2: IMO 1238 Preferred Horizontal Terrain Walking Speed

Within MassMotion, the ‘direction bias’ agent parameter is used to resolve conflicts with other agents. The ‘direction bias’ is defined by:

- the direction, i.e. none, left or right (default); and
- the strength, i.e. weak or strong (default).

The ‘direction bias’ parameters adopted for each scenario are identified in Table A7.1.

The MassMotion model of Scenario 1 is illustrated in Figure A7.2.

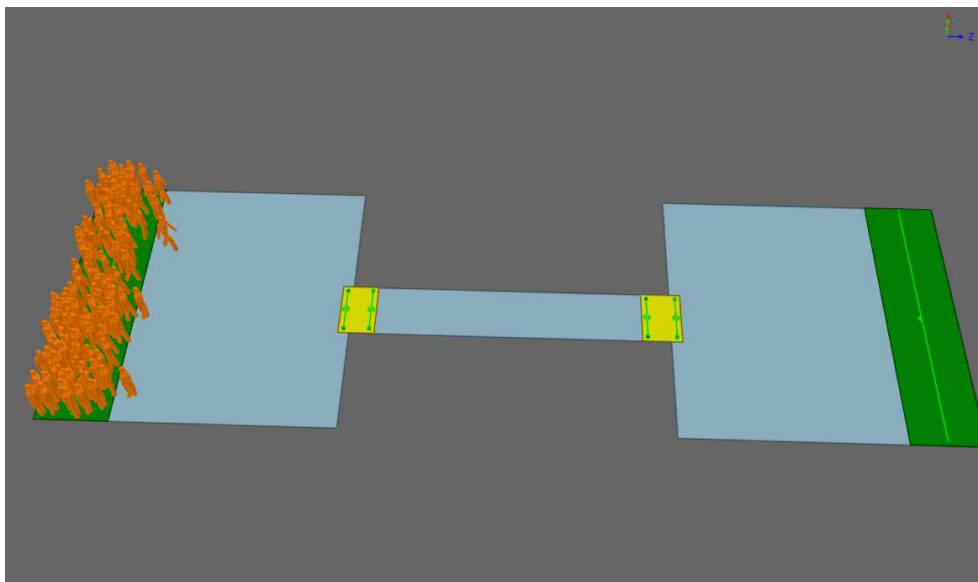
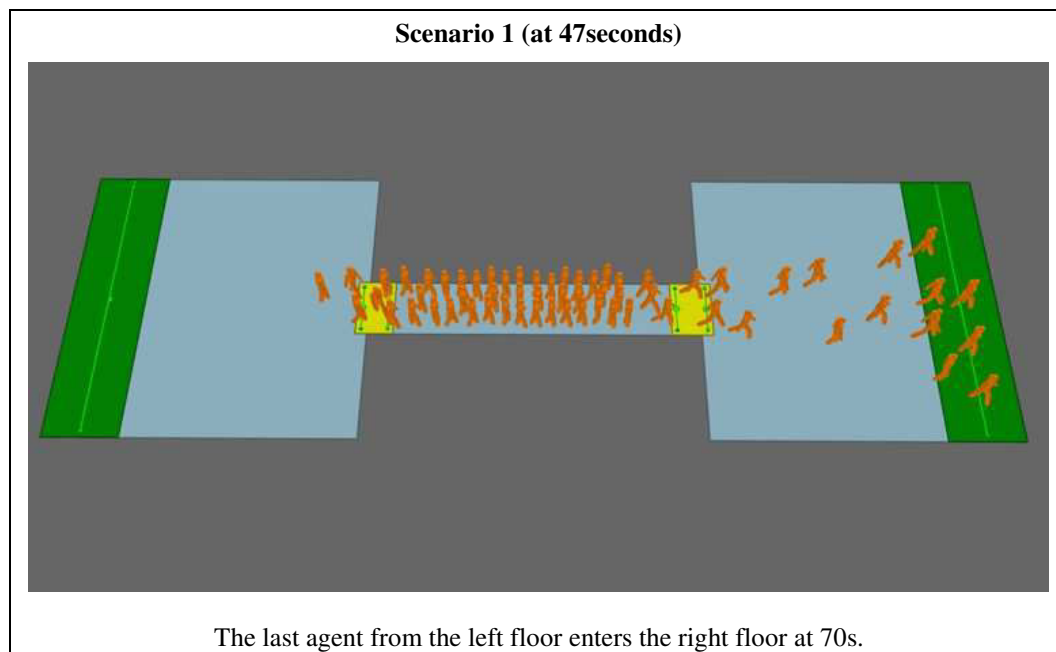

Figure A7.2: MassMotion Physical Geometry and Agent Population for Scenario 1

A7.4 Test Results

Figure A7.3 illustrates the simulation predictions at key times for each of the seven scenarios considered. Note that the agents starting in the left room are coloured **orange** while those starting in the right room are coloured **green**.



Scenario 2 (at 25seconds)

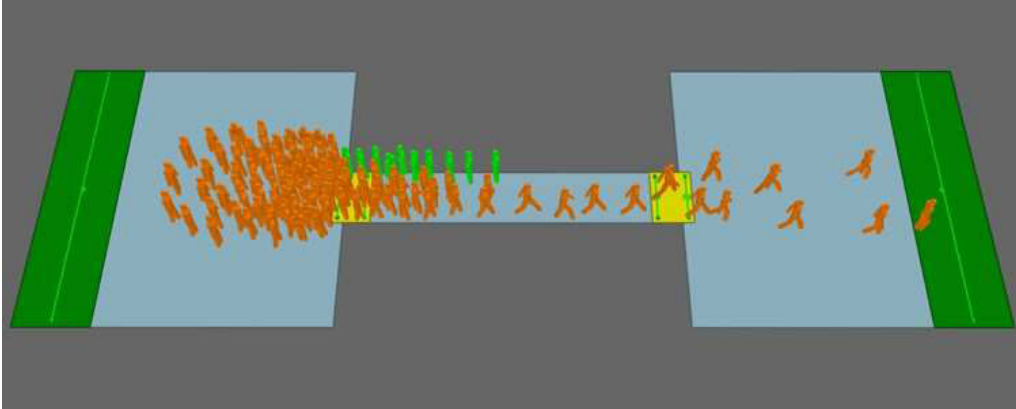

The last agent from the left floor enters the right floor at 80s.

Scenario 3 (at 25seconds)

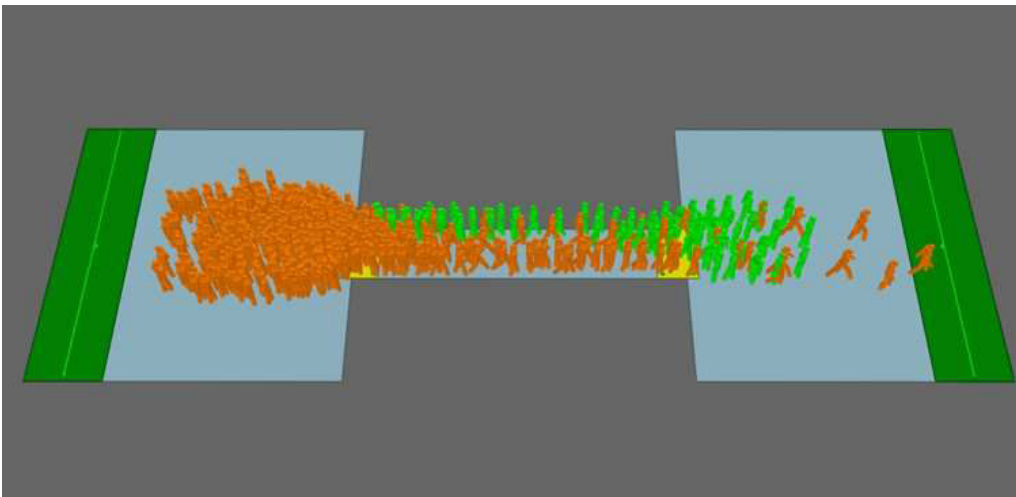

The last agent from the left floor enters the right floor at 136s.

Scenario 4 (at 38seconds)

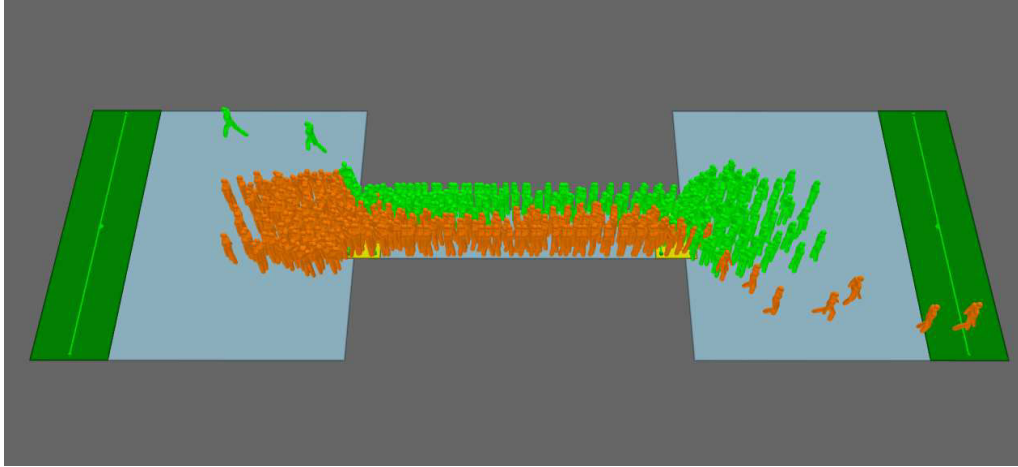

The last agent from the left floor enters the right floor at 208s.

Scenario 5 (at 53seconds)

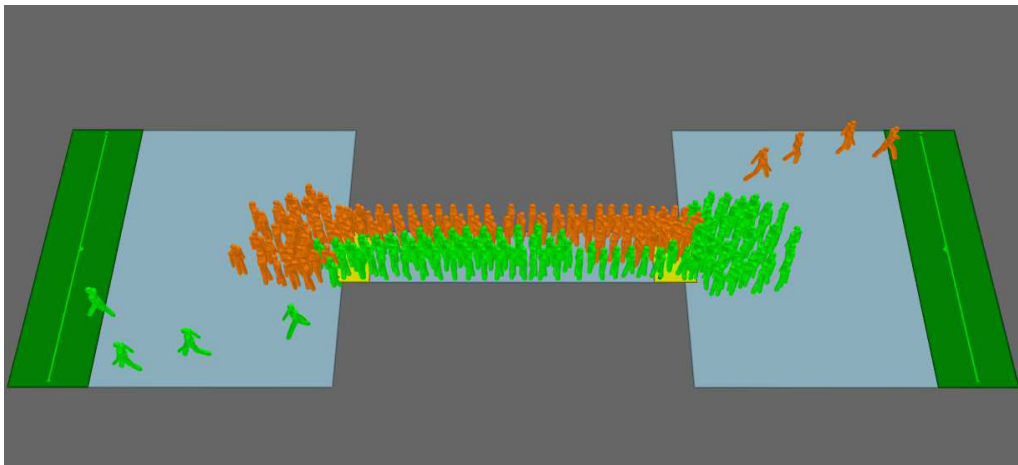

The last agent from the left floor enters the right floor at 160s.

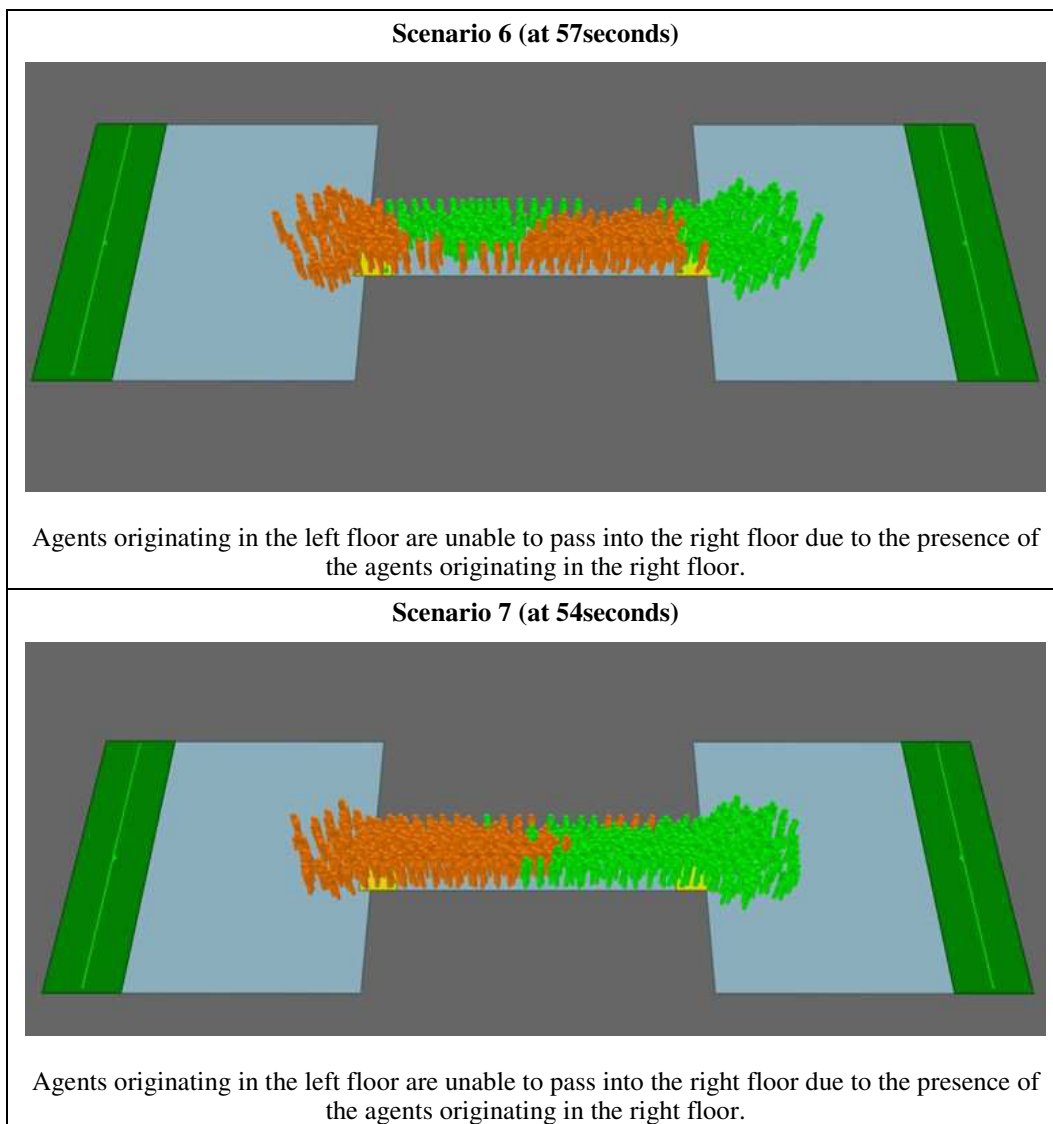

Figure A7.3: MassMotion Predictions for Each of the Seven Scenarios

Scenario 7 demonstrates that (strong) lock-up occurs when directional bias is not assigned to agents originating on either side of the counter-flow.

Scenario 6 demonstrates that lock-up occurs even when ‘weak’ directional bias is assigned to agents originating on either side of the counter flow.

Scenarios 4 and 5 demonstrate that lock-up does not occur when ‘strong’ directional bias is assigned to agents originating on either side of the counter-flow.

Scenarios 1, 2, 3 and 4 demonstrate that the time at which the last agent originating in the left floor enters the right floor increases with the increase in agents originating in the right floor.

Scenarios 4 and 5 illustrate that the agent group having the faster preferred horizontal domain walking speed (Males) are able to enter the right room (from the left room) more quickly when opposed by an agent group with a slower preferred horizontal domain walking speed (Females) than when facing a similar group (of Males).

A7.5 Conclusion

IMO 1238 Test 8 and NIST 1822 Test 2.8 have been conducted within MassMotion.

‘Lock-up’ (where agents are unable to transfer from one floor to the other) occurred in those cases where the opposing flow comprises of a large numbers of agents having a ‘direction bias’ strength defined as ‘weak’ (or ‘none’ when no direction is defined to the directional bias). MassMotion is not verified for use when large numbers of agents are involved in counter-flow situations and the ‘directional bias’ is defined to be ‘weak’ or ‘none’.

The predictions indicate that MassMotion is able to reproduce the results stated in the IMO and NIST guidance given the configured parameters of the model. (Specifically, that the time for the last agent originating in left floor to enter the right floor increases with the number of agents in the counter-flow.) MassMotion is verified for use when large numbers of agents are involved in counter-flow situations and the ‘directional bias’ is defined to be ‘strong’.

Status: Pass. (**Conditional – Subject to Appropriate Setting of the ‘Directional Bias’**).

A8 Test 9: Crowd Exit Usage

A8.1 Test Description

The test is in accordance with IMO 1238 Test 9.

The test considers a 30m x 20m floor having 4 x 1000mm exits. 1000 agents are uniformly distributed over the central 26m x 16m of the floor. See Figure A8.1.

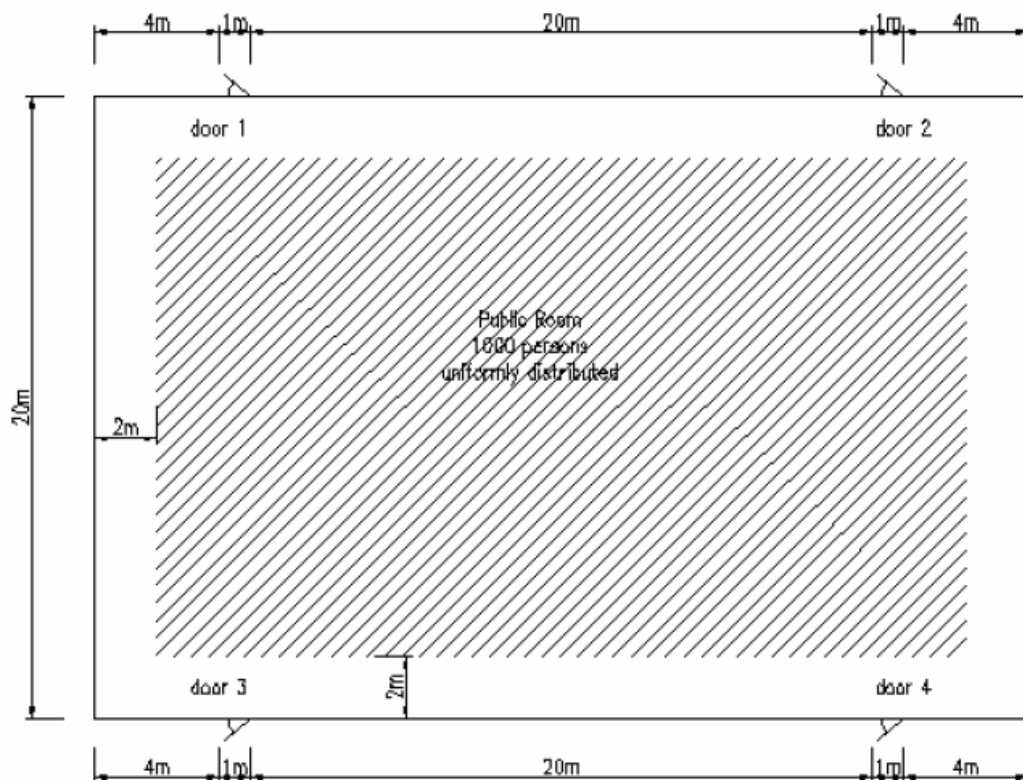

Figure A8.1: Exit Flow from a large public room (IMO Test 9, Figure 3)

Two scenarios are considered:

- **Scenario 1** – all 4 exits are open;
- **Scenario 2** – only exits '3' and '4' are open.

The test examines the MassMotion exit selection algorithm.

A8.2 Aim of Test

The purpose of the test is to verify that agents will assess the exit conditions (location, size, business) and choose an appropriate exit.

A8.3 Simulation Setup

The MassMotion physical environment (showing floors (5), entry portals (1), links (4), and exit portals (4)) is illustrated in Figures A8.2 and A8.3.

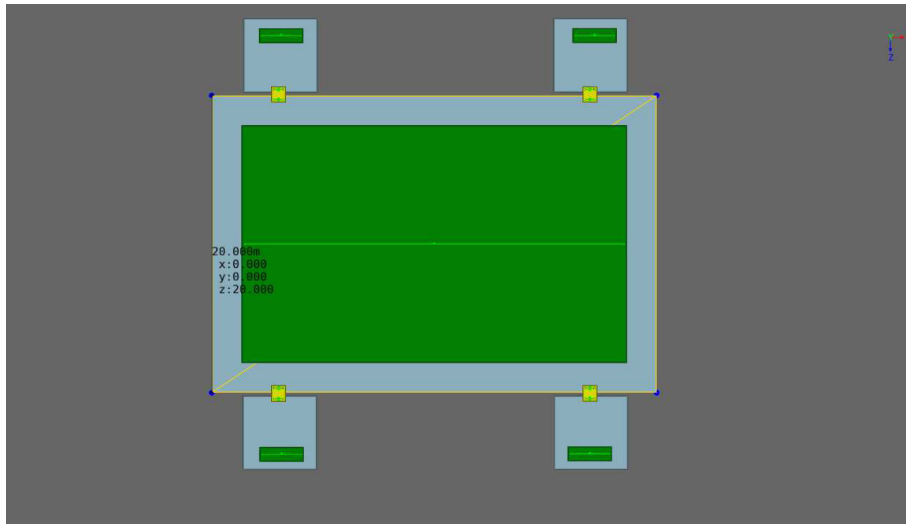

Figure A8.2: MassMotion Physical Environment

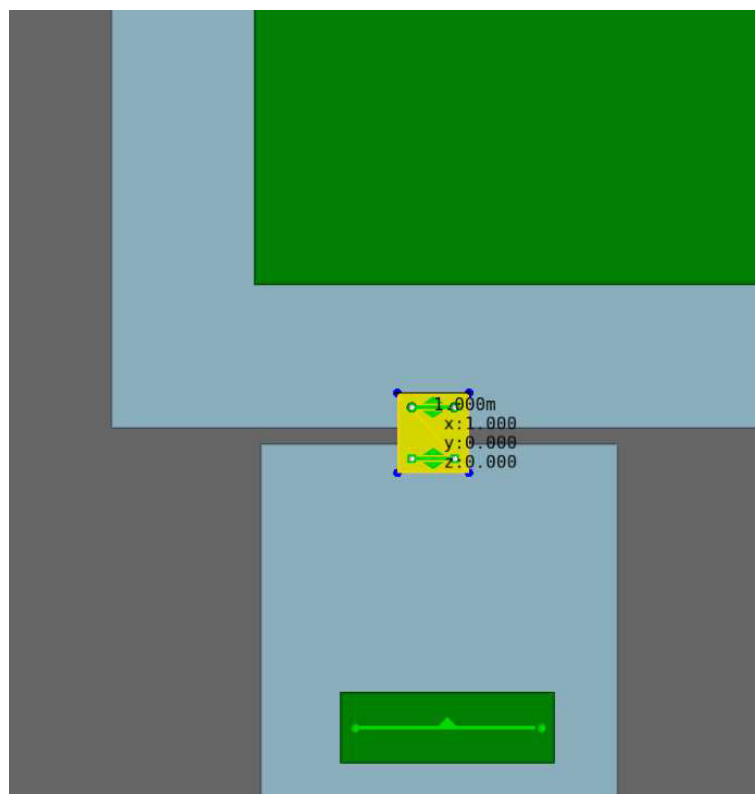

Figure A8.3: MassMotion Link

In Scenario 1:

- links 3 and 4 are not defined as ‘Gates’ and are, therefore, permanently available;

- links 1 and 2 are defined as ‘Gates’ with an ‘Open Gate Event’ set to open immediately.

In Scenario 2:

- links 3 and 4 are not defined as ‘Gates’ and are, therefore, permanently available;
- links 1 and 2 are defined as ‘Gates’ but without an ‘Open Gate Event’, with a Cost of Waiting set to 2,000,000s (representing a significant ‘wait cost’ and, therefore, making them extremely undesirable to an agent).

An IMO 1238 ‘Males 30-50’ agent profile was created (Figure A8.4).

The entry portal created 1000 agents within the central 26m x 16 m area (with a 2m gap to the edge) of the main floor.

An ‘Evacuation’ event was created (Figure A8.5 and A8.6) such that the agents have a zero pre-evacuation time.

An ‘Open Gate’ event was created for links 1 and 2 (as discussed previously).

All other parameters not identified above were assigned the MassMotion default values.

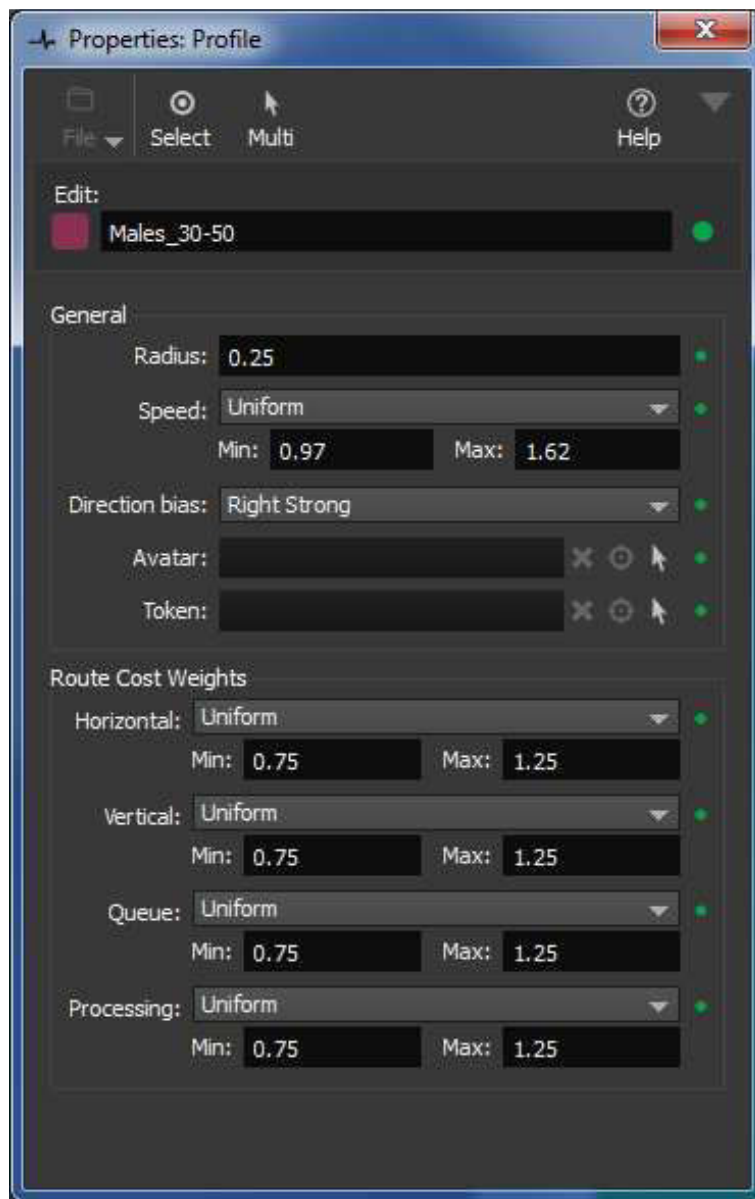

Figure A8.4: MassMotion Agent Profile

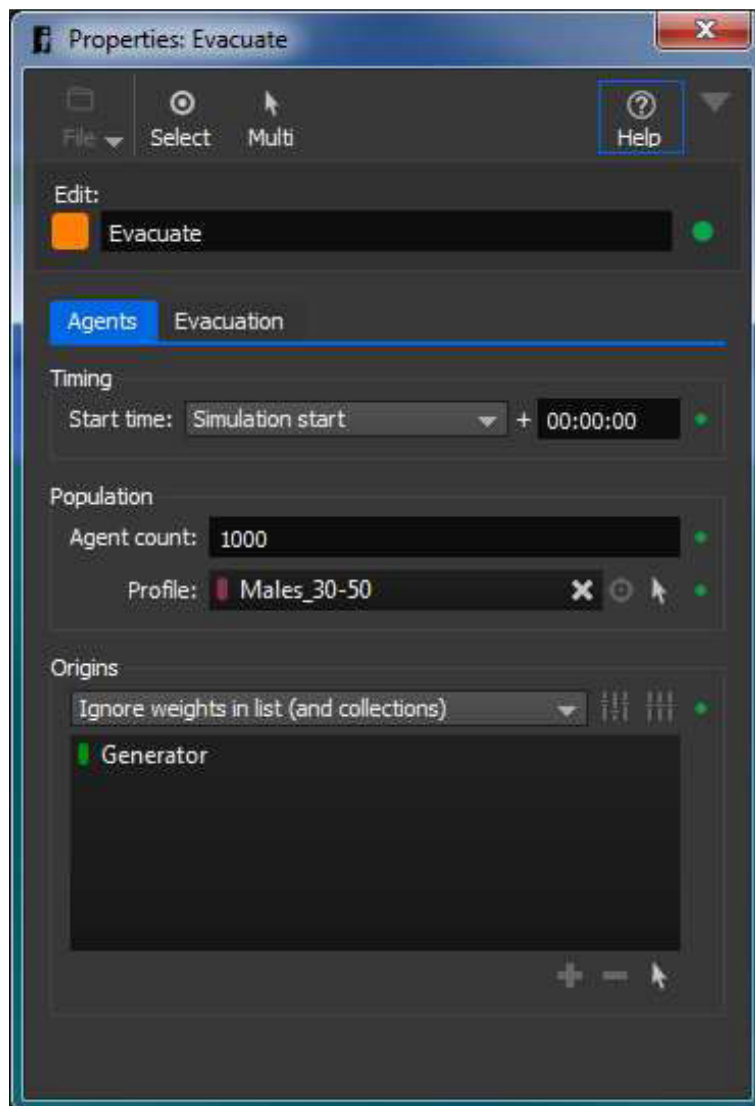

Figure A8.5: MassMotion Evacuation Event – Agents

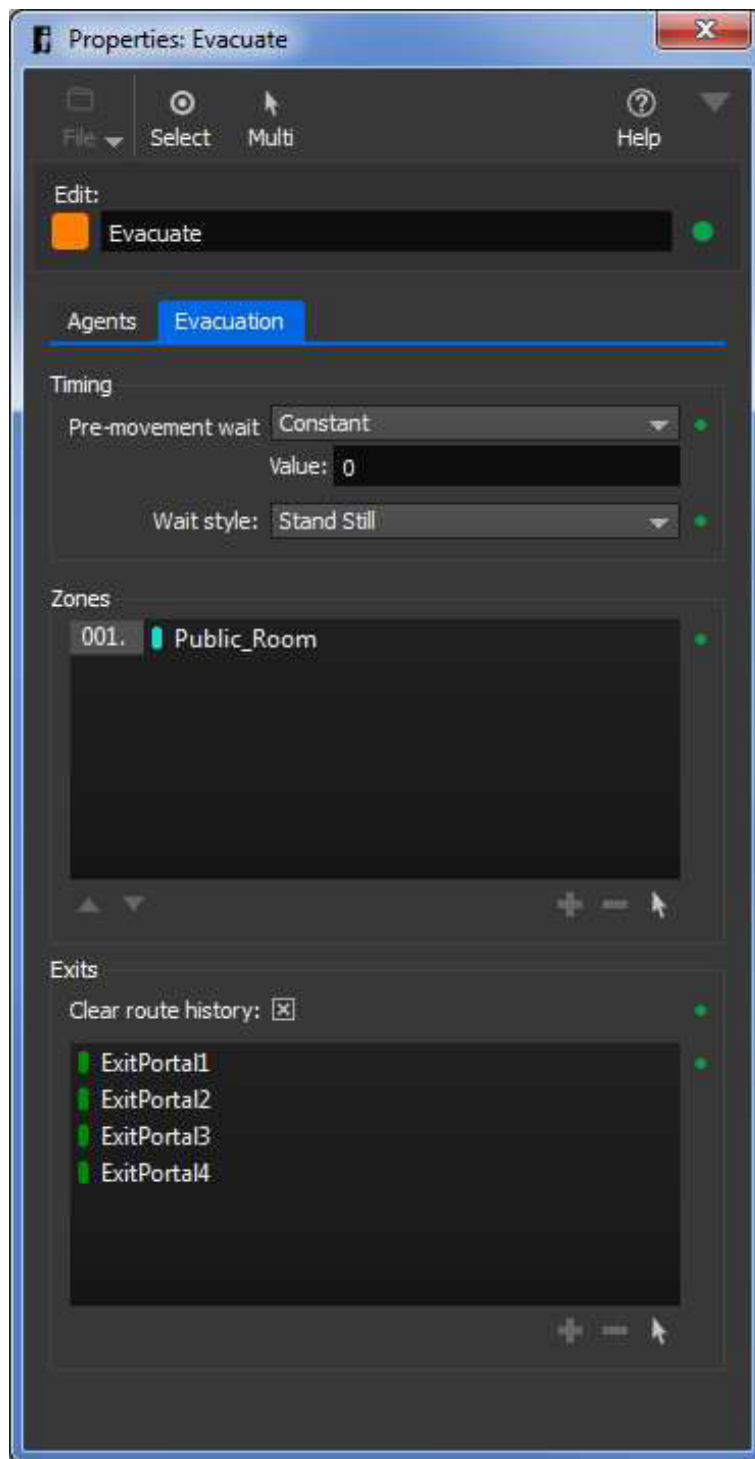

Figure A8.6: MassMotion Evacuation Event – Evacuation

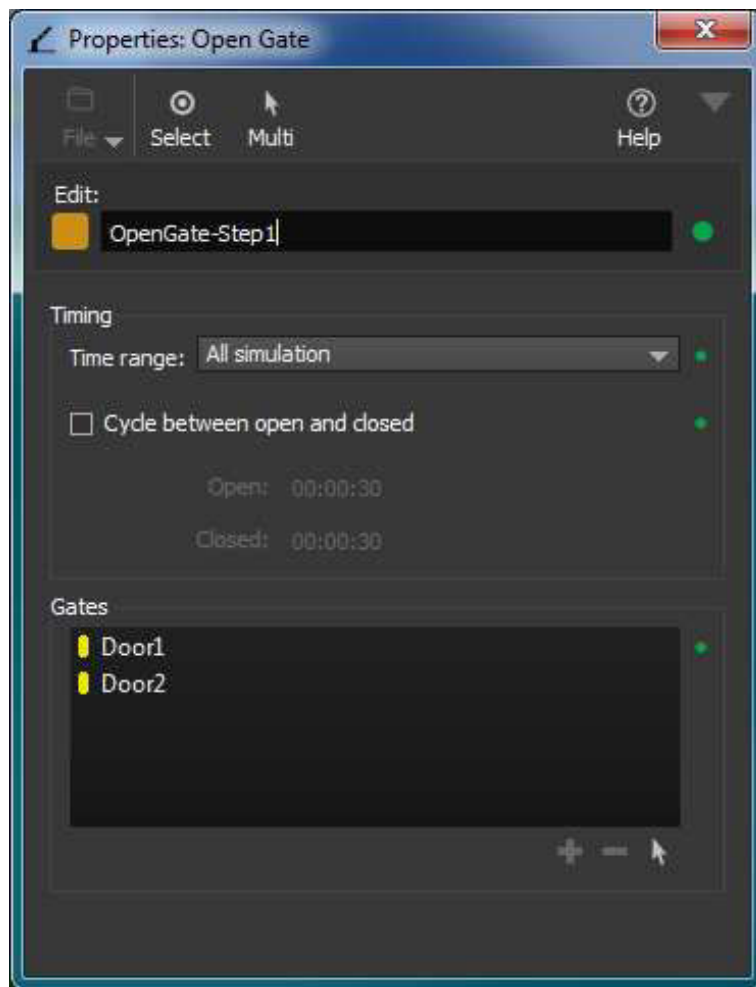

Figure A8.7: MassMotion: OpenGate Event

A8.4 Test Results

Typical agent queuing at the relevant exits is illustrated in

- Figure A8.8 for Scenario 1, and
- Figure A8.9 for Scenario 2.

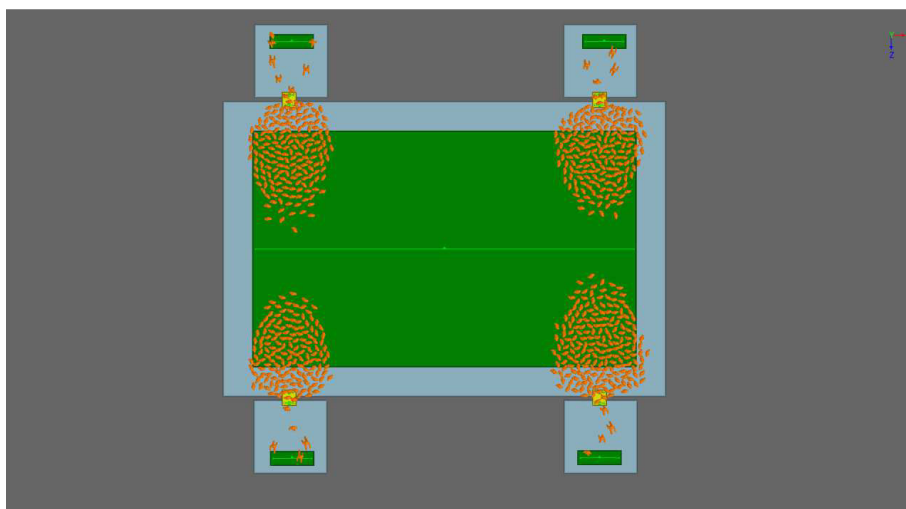

Figure A8.8: Scenario 1 – Exits 1, 2, 3, and 4 Open (Typical)

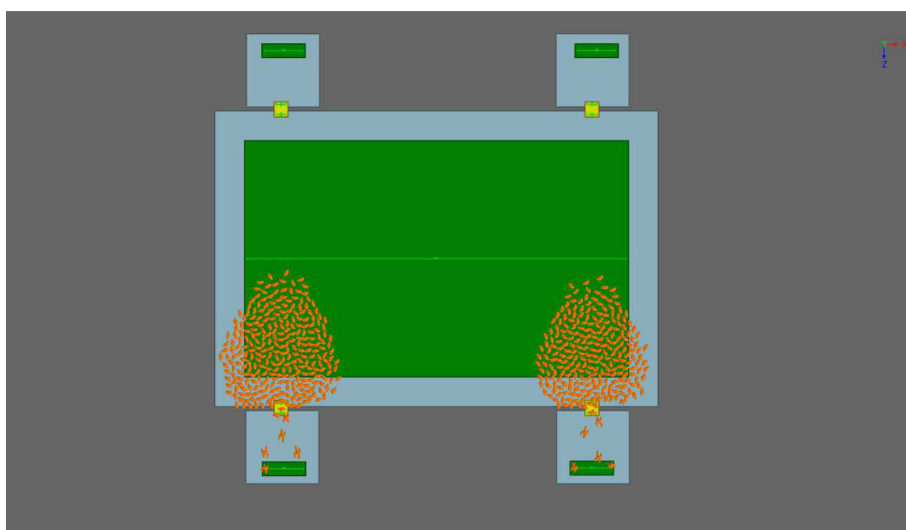

Figure A8.9: Scenario 2 – Exits 3 and 4 Open (Typical)

50 simulations were undertaken for both Scenario 1 and Scenario 2. A summary of the predicted total evacuation time from the simulations is provided in Table A8.1 and Figure A8.10.

	Total Evacuation Times (s)		
	Minimum	Maximum	Mean
Scenario 1 (Exits 1, 2, 3 and 4)	170	183	175.2
Scenario 2 (Exits 3 and 4)	335	347	340.7

Table A8.1: MassMotion Total Evacuation Time Predictions

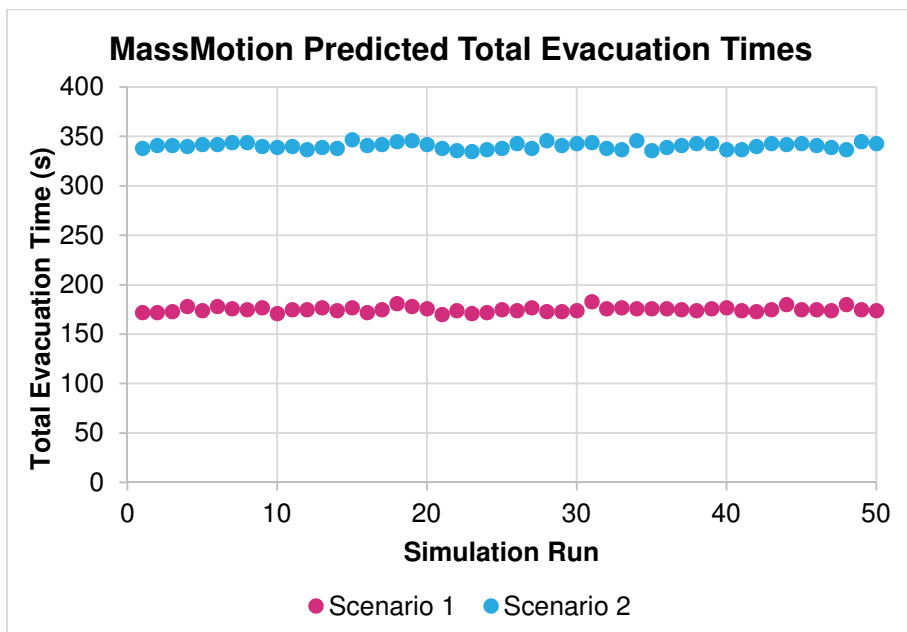

Figure A8.10: MassMotion Predicted Exit Times

This illustrates that the total evacuation time for Scenario 2 is approximately twice (the mean is x1.95) that of Scenario 1 – as would be anticipated.

A8.5 Conclusion

IMO 1238 Test 9 has been conducted within MassMotion.

The predictions indicate that MassMotion is able to reproduce the results stated in the IMO guidance given the configured parameters of the model.

Status: Pass.

A9 Test 10: Exit Allocation

A9.1 Test Description

The test is in accordance with IMO 1238 Test 10 and NIST 1822 Test 3.1.

The geometric layout (Figure A9.1) represents a cabin corridor.

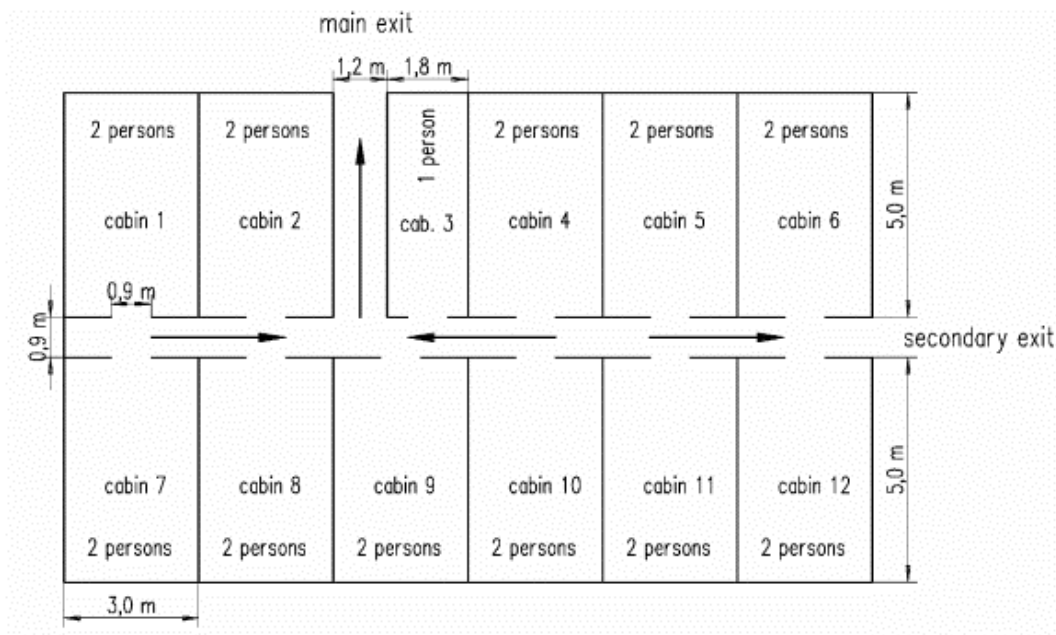

Figure A9.1: Configuration of Cabin Corridor

The cabins are populated as shown in Figure A9.1. Agents are assigned zero pre-evacuation time (i.e. instantaneous movement). The preferred horizontal terrain walking speeds are selected at random from a uniform probability distribution (ranging from 0.97m/s to 1.62m/s – see IMO 1238 population panel ‘Males 30-50’).

The agents (orange) in cabins 1, 2, 3, 4, 7, 8, 9, and 10 are allocated to the main exit.

The agents (blue) in cabins 5, 6, 11 and 12 are allocated to the secondary exit.

Two scenarios are considered:

- **Scenario 1** – IMO 1238 Test 10 and NIST 1822 Test 3.1 – as defined above.
- **Scenario 2** – The MassMotion exit selection algorithm (based on route cost) is applied to the agents.

The test is qualitative.

A9.2 Aim of Test

The purpose of the test is to provide qualitative verification of the ability of MassMotion to represent exit route allocation.

A9.3 Simulation Setup

The physical environment is shown in Figure A9.2

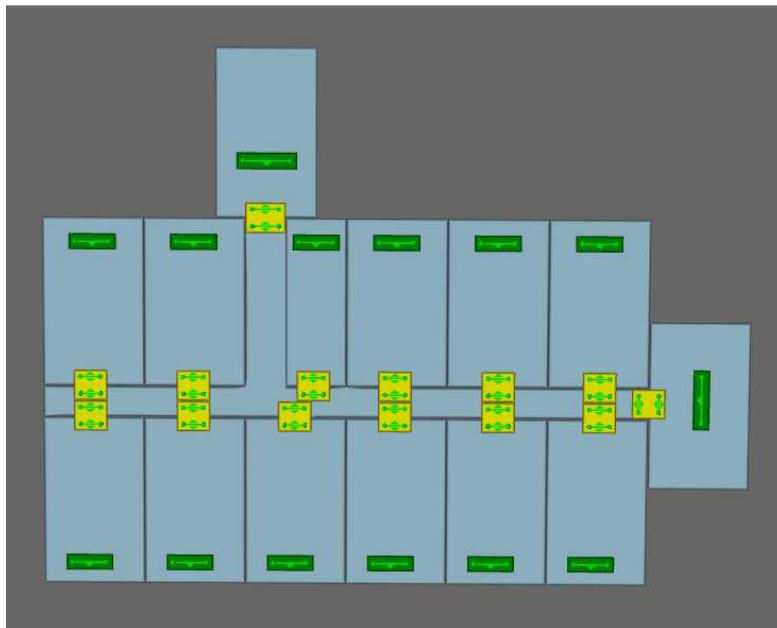

Figure A9.2: MassMotion Physical Environment

Floors were created to represent the cabins (12), corridor (1) and destinations (2).

Entry portals were created in each cabin. Exit portals were created at the destinations.

A9.4 Test Results

Table A9.2 (plus Figures A9.3 and A9.4, showing the agents departing from the cabins) summarises the MassMotion predictions for Scenarios 1 and 2.

Cabin		Number of Cabin Occupants Using Exit			
		Scenario 1: Defined Exit		Scenario 2: Route Selection	
Number	Persons	Main	Secondary	Main	Secondary
1	2	2	0	2	0
2	2	2	0	2	0
3	1	0	1	0	1
4	2	0	2	1	1
5	2	2	0	2	0
6	2	0	2	0	2
7	2	2	0	0	2
8	2	2	0	2	0
9	2	2	0	2	0
10	2	1	1	1	1
11	2	2	0	1	1
12	2	0	2	0	2
Total	23	15	8	13	10

Table A9.2: MassMotion Occupant Exit Predictions

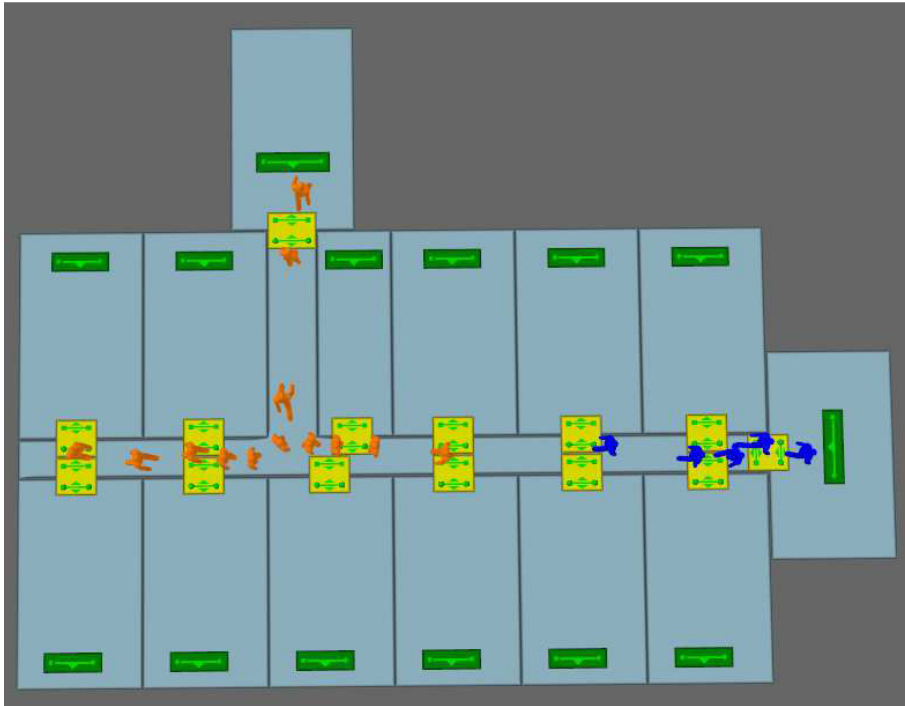

Figure A9.3: Scenario 1 – Agents Moving to Allocated Exit

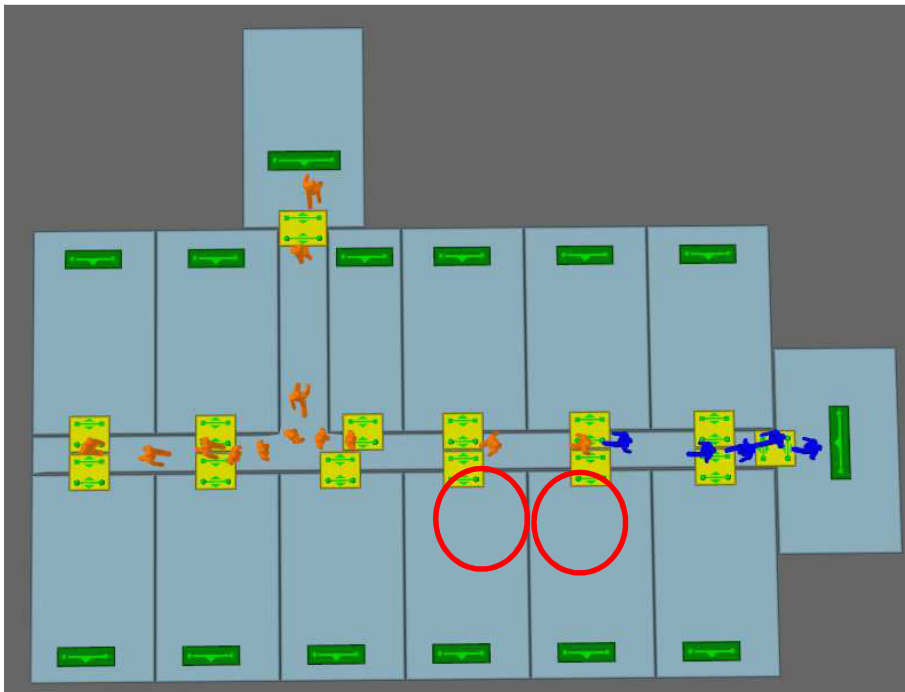

Figure A9.4: Scenario 2 – Agents Moving to Selected Exit

The MassMotion predictions indicate:

- Scenario 1 – all agents used the allocated exit;

- Scenario 2 – one agent from Cabin 4 and 1 agent from Cabin 10 (circled in **red** in Figure A9.4) chose to use the secondary exit (while all other agents adopted the same exit as in Scenario 1).

The agent behaviour identified in the latter is a function of the added travel distance and cost associated with accessing the corridor leading to the main exit.

A9.5 Conclusion

IMO 1238 Test 10 and NIST 1822 Test 3.1 have been conducted within MassMotion.

The Scenario 1 prediction identifies that the agents exiting the simulation do so at the allocated exit.

The predictions indicate that MassMotion is able to reproduce the results stated in the IMO and NIST guidance given the configured parameters (allocated exit) of the model.

Status: Pass.

A10 Test 11: Stair Congestion

A10.1 Test Description

The test is in accordance with IMO 1238 Test 11 and NIST 1822 Test 5.1.

An 8m x 5m floor (room) is connected via a 12m x 2m floor (corridor) to a 3m x 2m (3.6m diagonal) stair (Figure A10.1).

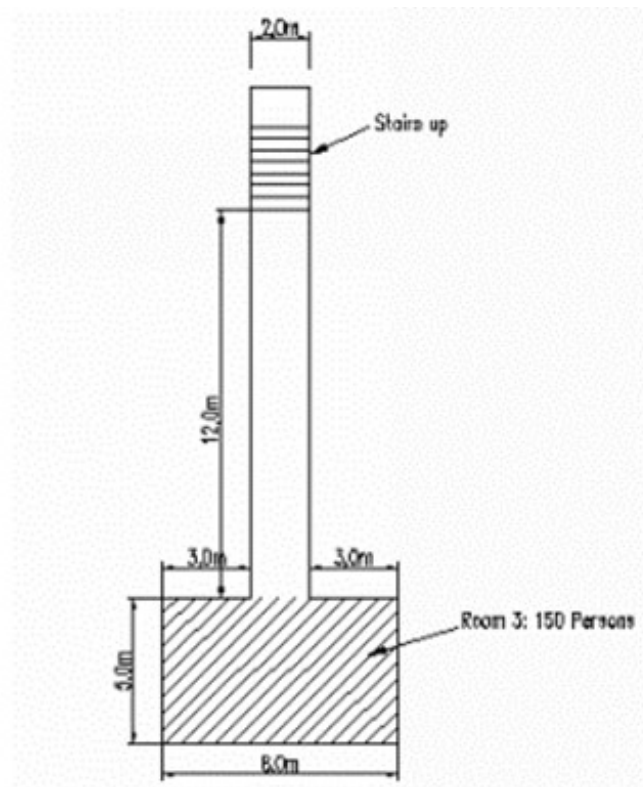

Figure A10.1: Geometric Layout (Scenario 1)

Four scenarios are to be considered:

- **Scenario 1** – 150 persons – stair up;
- **Scenario 2** – 100 persons – stair up;
- **Scenario 3** – 150 persons – stair down;
- **Scenario 4** – 100 persons – stair down.

The preferred horizontal terrain walking speeds are selected at random from a uniform probability distribution (ranging from 0.97m/s to 1.62m/s – see IMO 1238 population panel ‘Males 30-50’).

A10.2 Aim of Test

The purpose of the test is to verify that MassMotion is able to predict congestion at the exit of the room and at the base of the stair.

A10.3 Simulation Setup

Four distinct geometry elements were created:

- an 8m x 5m floor (room);
- a 12m x 2m floor (corridor);
- a 3m x 2m (with a 3.6m diagonal) stair;
- a destination floor.

A link was used to connect the room to the corridor.

An exit portal was created in the destination floor.

An entry portal was created in the room.

An IMO 1238 'Males 30-50' compatible agent profile was created. Agents were introduced to the model over a 1s duration and distributed uniformly over the entire room.

In all four scenarios, the journey is from the room to the head (stair up) or foot (stair down) of the stair.

A10.4 Test Results

The MassMotion simulation predictions are illustrated in Figures A10.2, A10.3, A10.4 and A10.5.

Scenario 1 – 150 Persons – Stair Up



Time: 1 second.
The room is populated by 150 agents which are distributed uniformly.

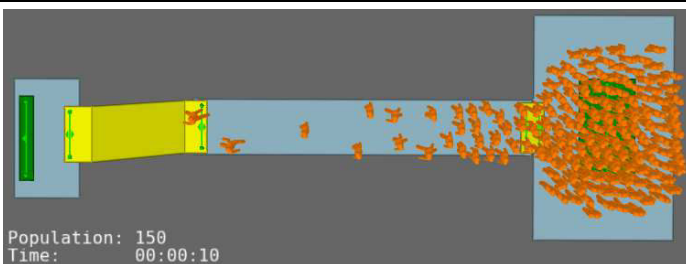

Time: 10 seconds.
There is congestion at the room exit.
The first agent reaches the foot of the upward stair.
There is no queuing at the stair.

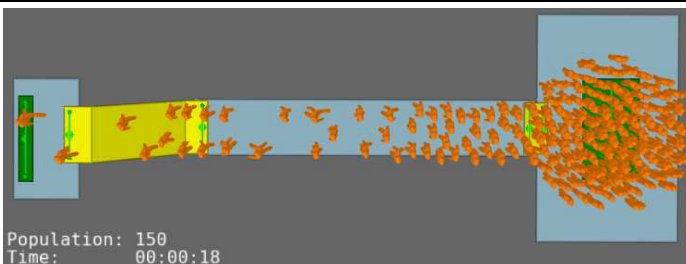

Time: 18 seconds.
There is congestion at the room exit.
There is no queuing at the stair.
The first agent leaves the simulation after reaching the head of the stair.

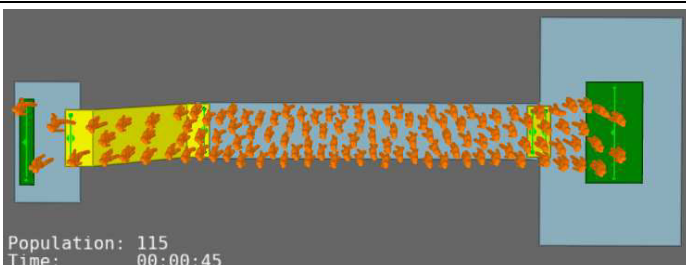

Time: 45 seconds.
The last of the agents are leaving the room.
There is a high population density along the entire length of the corridor.
There is queuing at the stair.

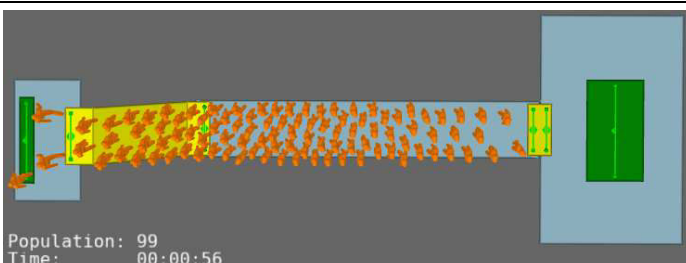

Time: 56 seconds.
All agents have left the room.
There is high population density in the corridor and on the stair. (There is queuing at the stair.)

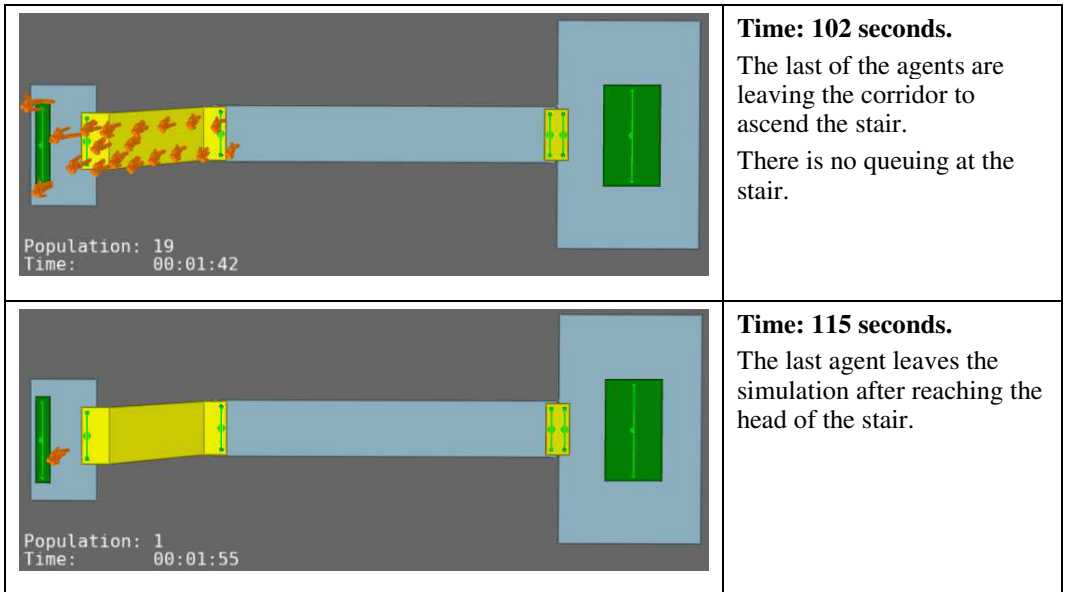
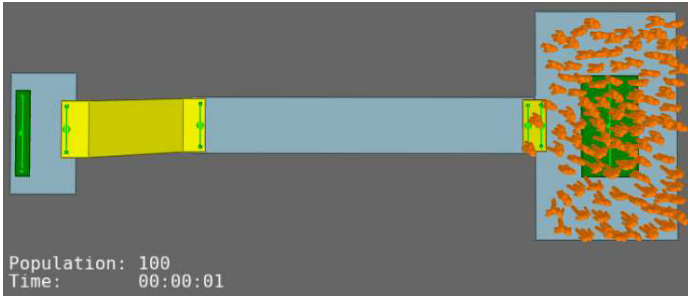
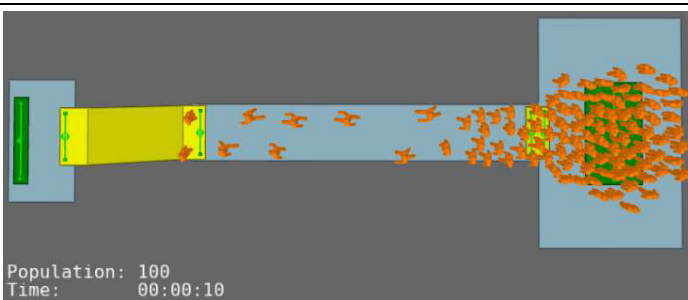

Figure A10.2: Scenario 1 (150 Persons – Stair Up)

Scenario 2 – 100 Persons – Stair Up



Time: 1 second.
The room is populated by 100 agents which are distributed uniformly.



Time: 10 seconds.
There is congestion at the room exit.
The first agent reaches the foot of the upward stair. (Approximately the same time as in the IMO 1238 Test 11.) There is no queuing at the stair.

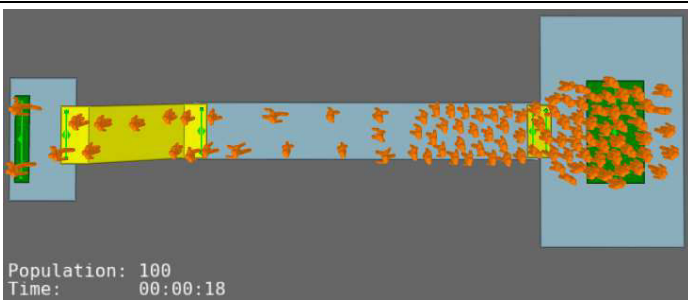

Time: 18 seconds.
There is congestion at the room exit.
There is no queuing at the stair.
The first agent leaves the simulation after reaching the head of the stair.

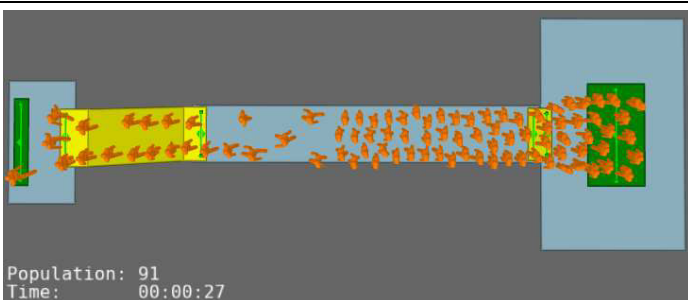

Time: 27 seconds.
The population density in the corridor increases.
There is no queuing at the stair.

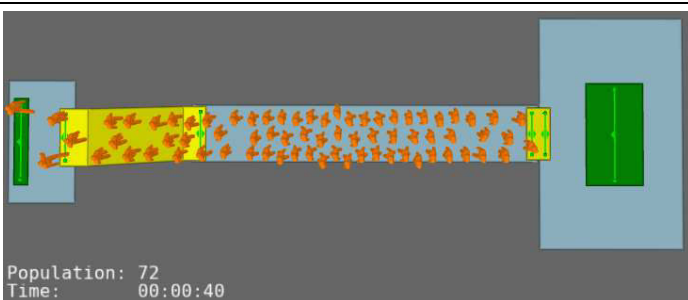

Time: 40 seconds.
All agents have left the room.
There is high population density in the corridor.
There is no queuing at the stair.

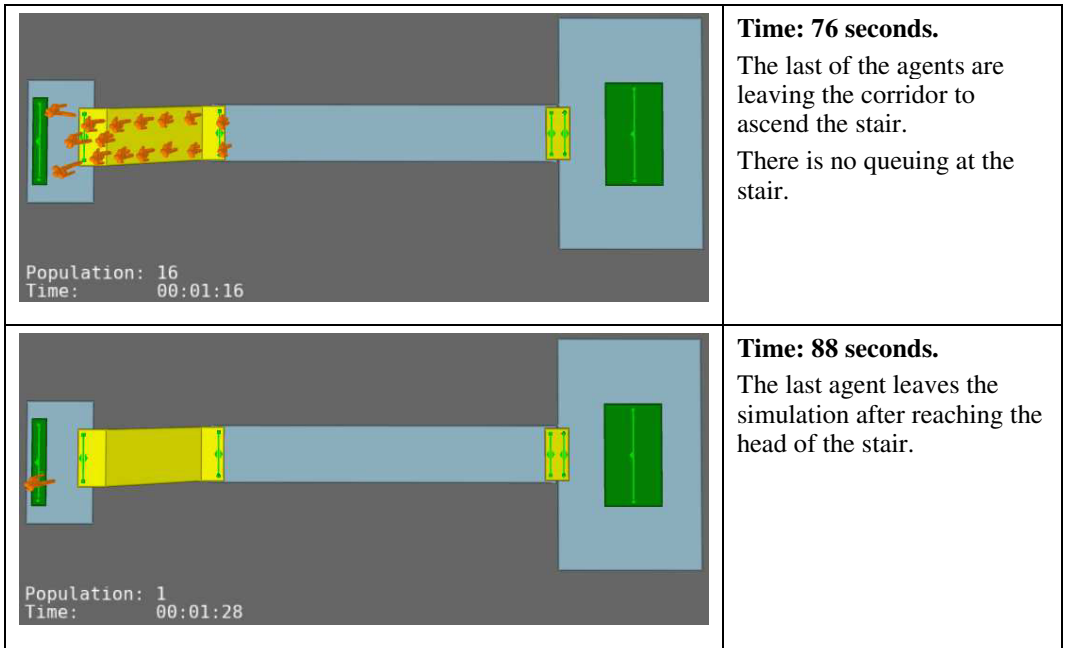

Figure A10.3: Scenario 2 (100 Persons – Stair Up)

Scenario 3 – 150 Persons – Stair Down



Time: 1 second.

The room is populated by 150 agents which are distributed uniformly.

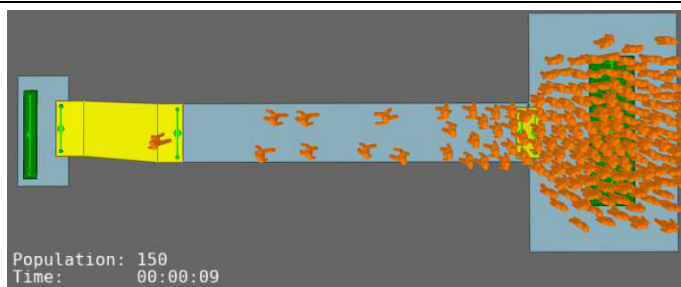

Time: 9 seconds.

There is congestion at the room exit.

The first agent reaches the head of the downward stair. There is no queuing at the stair.

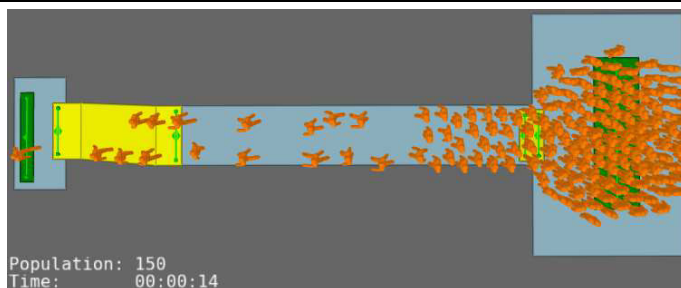

Time: 14 seconds.

There is congestion at the room exit.

There is no queuing at the stair.

The first agent leaves the simulation after reaching the foot of the stair.

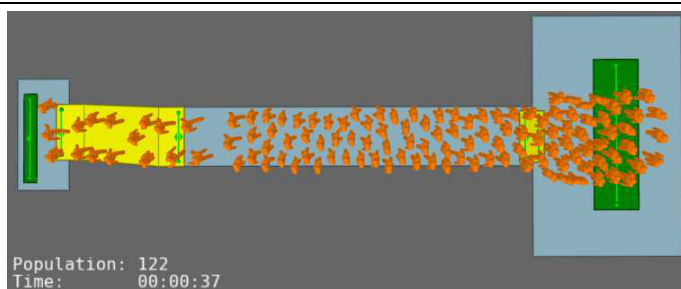

Time: 37 seconds.

The population density in the corridor increases.

There is no queuing at the stair.

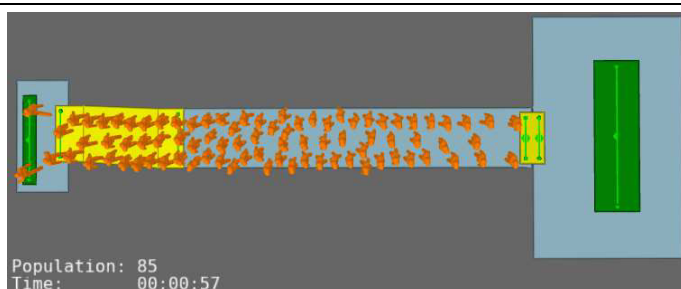

Time: 57 seconds.

All agents have left the room.

There is high population density in the corridor and on the stair. (There is queuing at the stair.)

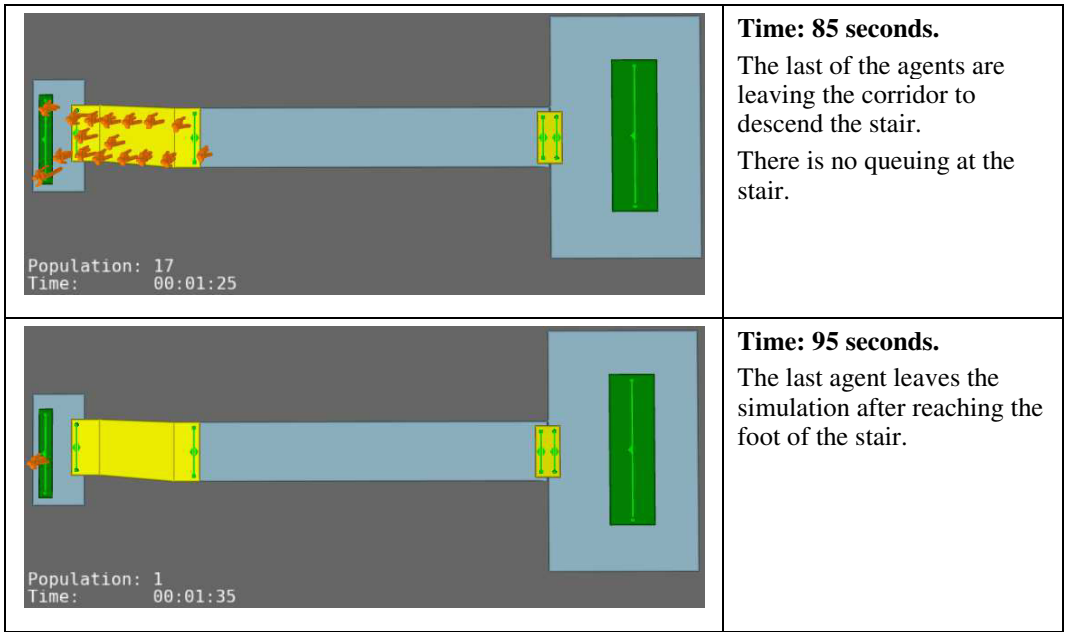
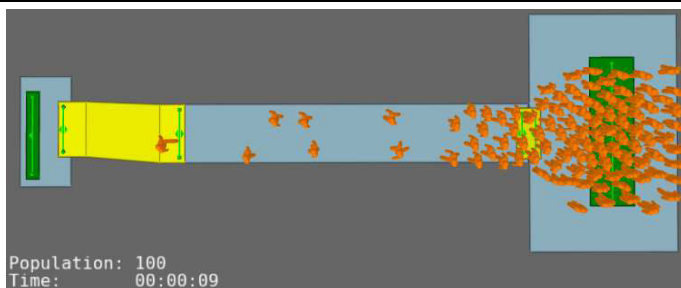

Figure A10.4: Scenario 3 (150 Persons – Stair Down)

Scenario 4 – 100 Persons – Stair Down



Time: 1 second.
The room is populated by 100 agents which are distributed uniformly.



Time: 9 seconds.
There is congestion at the room exit.
The first agent reaches the head of the downward stair.
There is no queuing at the stair.

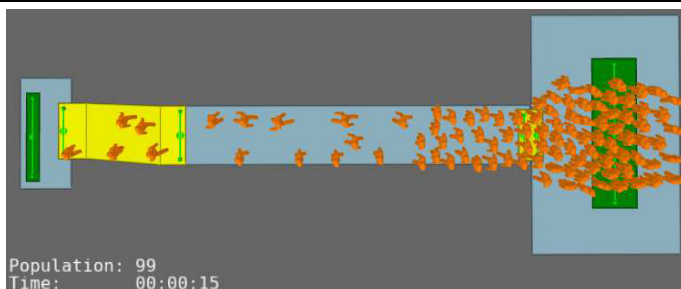

Time: 15 seconds.
There is congestion at the room exit.
There is no queuing at the stair.
The first agent leaves the simulation after reaching the foot of the stair.

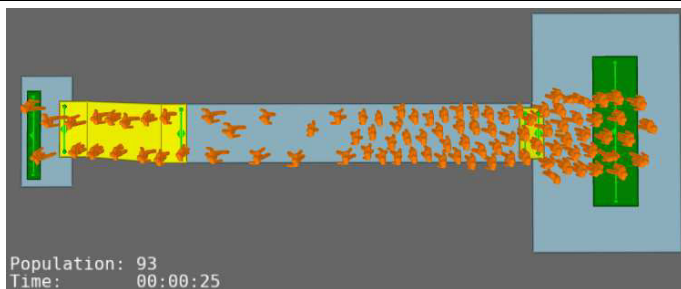

Time: 25 seconds.
The population density in the corridor increases.
There is no queuing at the stair.

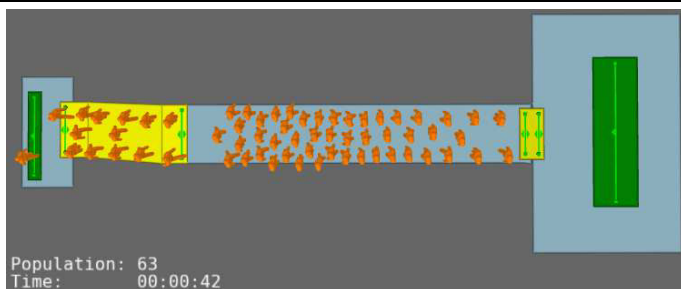

Time: 42 seconds.
All agents have left the room.
There is no queuing at the stair.

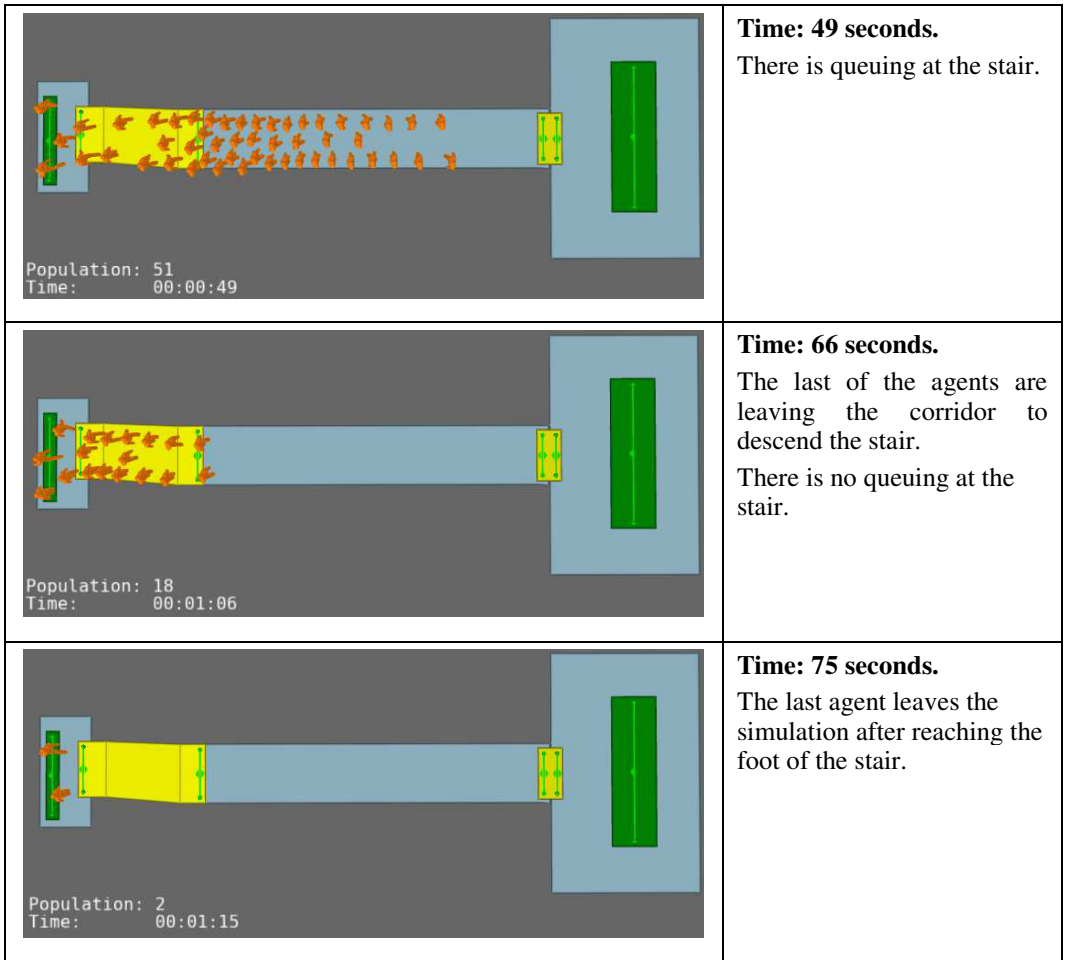

Figure A10.5: Scenario 4 (100 Persons – Stair Down)

A10.5 Conclusion

IMO 1238 Test 11 and NIST 1822 Test 5.1 has been conducted within MassMotion.

Qualitative assessment of the simulation predictions illustrate the ability of MassMotion to replicate congestion:

- at the exit from the room;
- at the end of the corridor adjacent to the stair.

The extent of the congestion at the latter is a function of the direction of the stair (greater congestion is noted for an upward stair than for a downward stair) and the initial room population (an increased population leads to increased congestion).

The predictions indicate that MassMotion is able to reproduce the results (in the form of the qualitative nature of the congestion, i.e. its location and extent) stated in the IMO and NIST guidance given the configured parameters of the model.

Status: Pass.

A11 Test 12: Movement Disabilities

A11.1 Test Description

The test is in accordance with NIST 1822 Test 2.10. There is no associated IMO 1238 test.

Two 5m x 4m floors (rooms) at different elevations are connected by a 2m x 1.5m ramp. (Room 1 is located 1m above ground level while Room 2 is located at ground level.) A 1000mm exit is located at the boundary of Room 2 remote from the ramp. (Figure A11.1.)

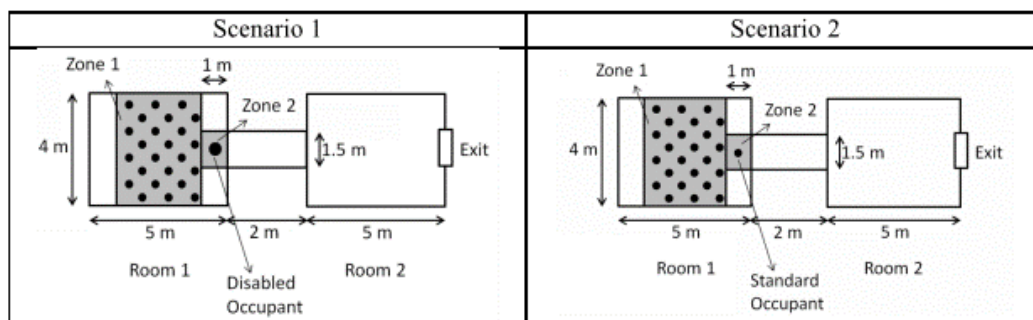

Figure A11.1: Geometric Layout

A 3m x 4m area of Room 1 located 1m from the ramp, (Zone 1) is populated by 24 agents having:

- the default body size (0.5m diameter);
- a preferred horizontal terrain walking speed of 1.25m/s.

Two scenarios are considered:

- **Scenario 1** – A 1m x 1.5m area of Room 1 immediately adjacent to the ramp (Zone 2) is populated by a ‘mobility impaired’ agent having:
 - a body size greater than half the width of the ramp (i.e. > 0.75m), e.g. a wheelchair user;
 - a preferred horizontal terrain walking speed of 0.8m/s;
 - a preferred ramp walking speed of 0.4m/s.

All agents leave the simulation via the exit from Room 2.

- **Scenario 2** – Differs from Scenario 1 only in that the single agent of Zone 2 has the same agent attributes as those in Zone 1 (i.e. no mobility impaired agents are included).

A11.2 Aim of Test

The purpose of the test is to verify that MassMotion is able to predict that the flow of agents is restricted by the presence of a mobility impaired agent (being relatively larger and slower) in a confined space.

A11.3 Simulation Setup

The only deviation from the test description concerns the speed of the mobility impaired agent. MassMotion applies the same factor (in this case 100%) to the preferred horizontal terrain walking

speeds of all the agents ('able-bodied' and 'mobility impaired') when on the ramp. The preferred horizontal terrain walking speed of the mobility impaired agent is, therefore, set to 0.4m/s (slower than that defined in the test description) such that the resultant speed on the ramp is 0.4m/s. The movement of the mobility impaired agent is slower (compared to the test description) on the horizontal floors: overtaking is possible on the horizontal floors and, therefore, the slower movement of the mobility impaired agent should have limited impact.

A sensitivity test for the width of the mobility impaired agent has been undertaken for Scenario 1:

- 0.25m –physically unrealistic for an adult (the agent is too small);
- 1.0m – satisfies the requirement of the test;
- 1.5m – the width of the ramp;
- 2.0m –physically unrealistic (greater than the width of the ramp).

While the 0.25m and 2.0m widths are physically unrealistic, they are included for comparative purposes. (Figure A11.2 illustrates these four cases alongside Scenario 2.)

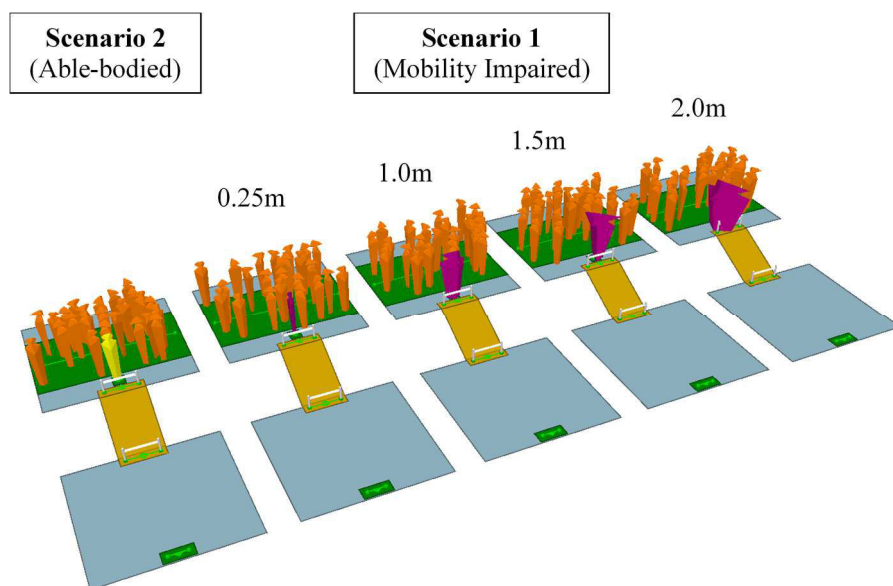

Figure A11.2: MassMotion Models for Scenario 2 and Scenario 1 (x4)

A11.4 Test Results

Figure A11.3 illustrates the MassMotion predictions when the mobility impaired agents of Scenario 1 are still on the ramp.

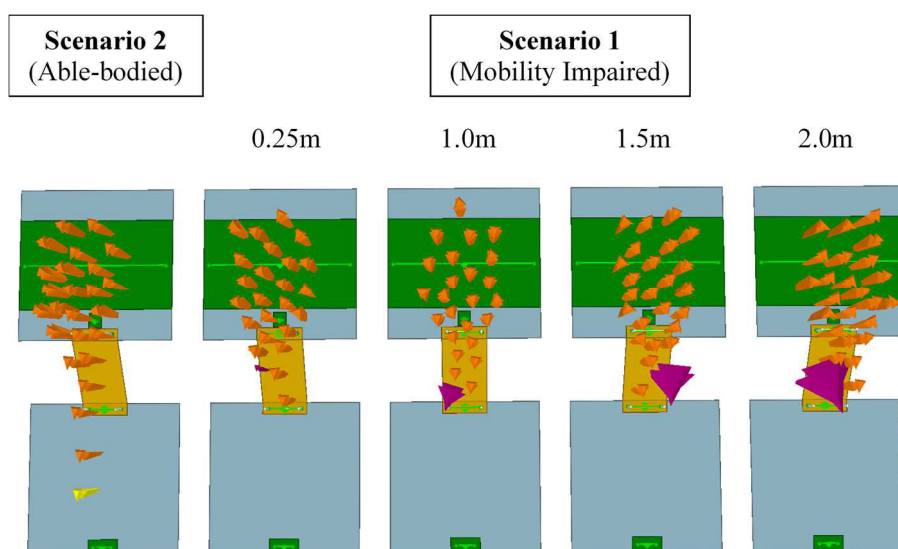

Figure A11.3: MassMotion Simulations of Scenario 2 and Scenario 1 (x4)

For Scenario 1, agents originating in Zone 1 have been impeded by the 1.0m, 1.5m and 2.0m mobility impaired agent of Zone 2 to the extent that they were unable to overtake whilst on the 1.5m wide ramp. Agents originating in Zone 1 were able to overtake the 0.25m mobility impaired agent whilst on the 1.5m wide ramp.

For Scenario 2, the able-bodied agent of Zone 2 has the same preferred walking speed as the agents originating and Zone 1 and, therefore:

- is in advance of the agents originating in Zone 1 in moving towards the exit portal;
- has travelled down the ramp and is well into Room 2 at the corresponding time that the mobility impaired agents are still on the ramp.

In undertaking these simulations, it was noted that:

- in all cases, the presence of the slower agent impeded the exit rate of other agents;
- the actual size of the slower agent had less effect than the random variations within a simulation (as a function of the initial positions of the agents);
- in some cases, faster agents were able to pass the slower agent before it reached the ramp.

A11.5 Conclusion

NIST 1822 Test 2.10 has been conducted within MassMotion.

The predictions indicate that MassMotion is able to reproduce the results (in the form of the qualitative nature of the impedance of faster agents by a slower agent in a confined environment) stated in NIST guidance given the configured parameters of the model.

Status: Pass.

A12 Test 13: Affiliation

A12.1 Test Description

The test is in accordance with NIST 1822 Test 3.3.

Within this test the term ‘Affiliation’ refers to familiarity / preference for a particular exit.

A 15m x 10m floor (room) has two 1000mm exits located:

- on opposing 15m walls;
- such that the centre of the exit is 12m from one of the 10m walls.

(Figure A12.1.)

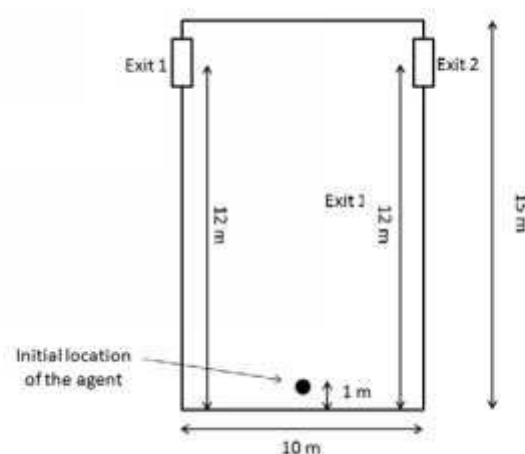

Figure A12.1: Geometric Layout

Two scenarios for the evacuation of a single agent (initially at the centre of the 10m wall remote from the exits) are considered:

- **Scenario 1** – the agent is unfamiliar with both exits;
- **Scenario 2** – the agent is not affiliated (familiar) with Exit 2, i.e. Exit 1 is favoured by the agent.

A12.2 Aim of Test

The purpose of the test is to demonstrate that an agent's increased familiarity with a given exit can be represented and configured within MassMotion.

A12.3 Simulation Setup

The MassMotion physical environment (Figure A12.2) consists of:

- 3 floors (the room and 2 destination areas);
- 2 links (to connect the room to the destination areas at the exits);

- 1 entry portal (associated with the room);
- 2 exit portals (associated with the destination areas).

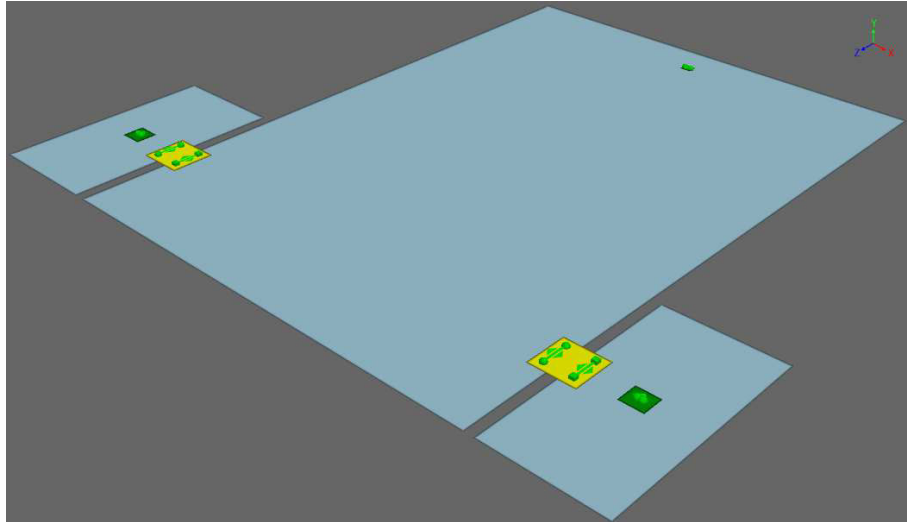

Figure A12.2: MassMotion Physical Environment

The agent was assigned a preferred horizontal terrain walking speed of 1m/s. (All other attributes were as per MassMotion defaults.). The agent was generated within 1s of the start of the simulation.

For Scenario 2, a sensitivity test was undertaken to examine the extent to which Exit 1 is favoured. The exit weights are as defined in Table A12.1.

Exit	Weight (%)		
ID	Scenario 1	Scenario 2	
		Case A	Case B
1	50	75	99
2	50	25	1

Table A12.1: Exit Weights

100 simulations were undertaken for Scenario 1 and both Cases of Scenario 2.

A12.4 Test Results

The frequency of usage of each exit over the 100 simulations is summarised in Table A12.2.

Scenario	Case	Exit Usage	
		Exit 1	Exit 2
1	–	48	52
2	A	73	27
2	B	99	1

Table A12.2: MassMotion Predicted Exit Usage

This demonstrates that the MassMotion predictions for exit usage (and, therefore, the probability of exit usage) follow the weightings applied to the exits as input.

A12.5 Conclusion

NIST 1822 Test 3.3 has been conducted within MassMotion.

Results from the test indicate MassMotion is able to reproduce the results stated in the NIST guidance given the configured parameters of the model.

Status: Pass.

A13 Test 14: Dynamic Availability of Exits

A13.1 Test Description

The test is in accordance with NIST 1822 Test 4.1.

A 15m x 10m floor (room) has two 1000mm exits located:

- on opposing 15m walls;
- such that the centre of the exit is 12m from one of the 10m walls.

(Figure A13.1.)

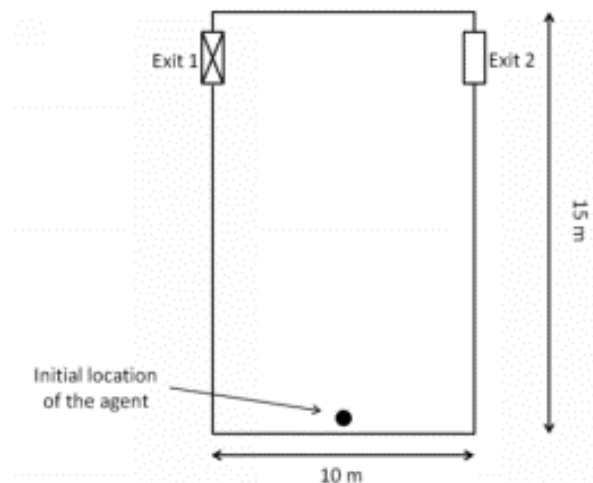

Figure A13.1: Geometric Layout

Both Exit 1 and Exit 2 are available initially. After 1 second, Exit 1 becomes unavailable.

Evacuation of a single agent (initially at the centre of the 10m wall remote from the exits) is considered.

A13.2 Aim of Test

The purpose of the test is to demonstrate that MassMotion is able to represent the dynamic availability of exits.

A13.3 Simulation Setup

The MassMotion physical environment (Figure A13.2) consists of:

- 3 floors (the room and 2 destination areas);
- 2 links (to connect the room to the destination areas at the exits);
- 1 entry portal (associated with the room);
- 2 exit portals (associated with the destination areas).

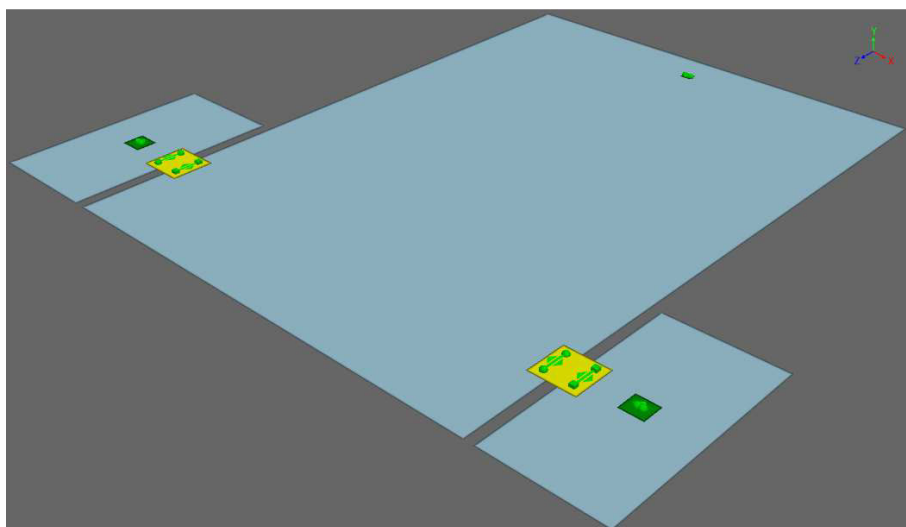

Figure A13.2: MassMotion Physical Environment

The following parameters were set for the simulation. (Any parameter not specified was taken to as per the MassMotion default.)

- Profile:
 - Preferred horizontal terrain walking speed = constant;
 - Value = 1m/s.
- Journey:
 - Timing duration = 1s;
 - Agent count = 1;
 - Entry portal (weight = 1);
 - Exit portal 1 (weight = 0.5);
 - Exit portal 2 (weight = 0.5).
- Links to Exit 1 and Exit 2:
 - Enabled to be used as a 'Gate';
 - Cost of waiting = 100,000s (i.e. a big cost).
- 'Open Gate' event for Exit 1:
 - **Scenario 1** – Gate to be **Open** from 0s to 2s simulation time;
 - **Scenario 2** – Gate to be **Open** from 0s to 7s simulation time.
- 'Open Gate' event for Exit 2:
 - Gate to be **Closed** from 0s to 1s simulation time (to force the agent to prefer Exit 1 initially);
 - Gate to be **Open** from 1s to simulation end.
- Evacuate:
 - Agent count = 1;
 - Profile = as above;
 - Origin = entry portal;
 - Destinations = exit portals.

A13.4 Test Results

Agent route maps are illustrated in Figure A13.3 (Scenario 1) and Figure A13.4 (Scenario 2).

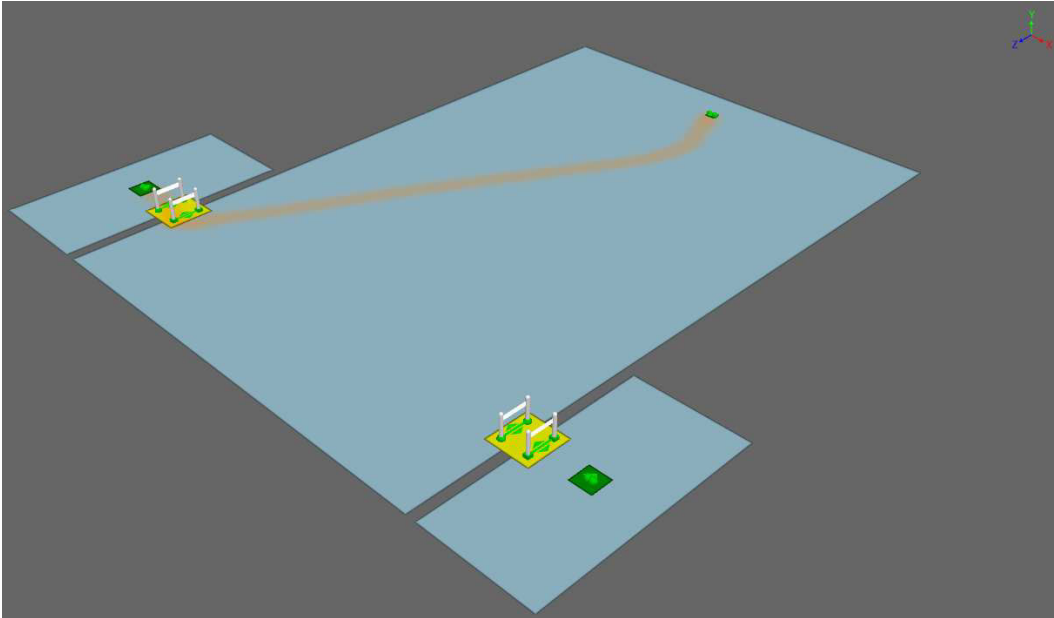

Figure A13.3: Predicted Agent Route Map for Scenario 1 (Exit 1 Closed at 1s)

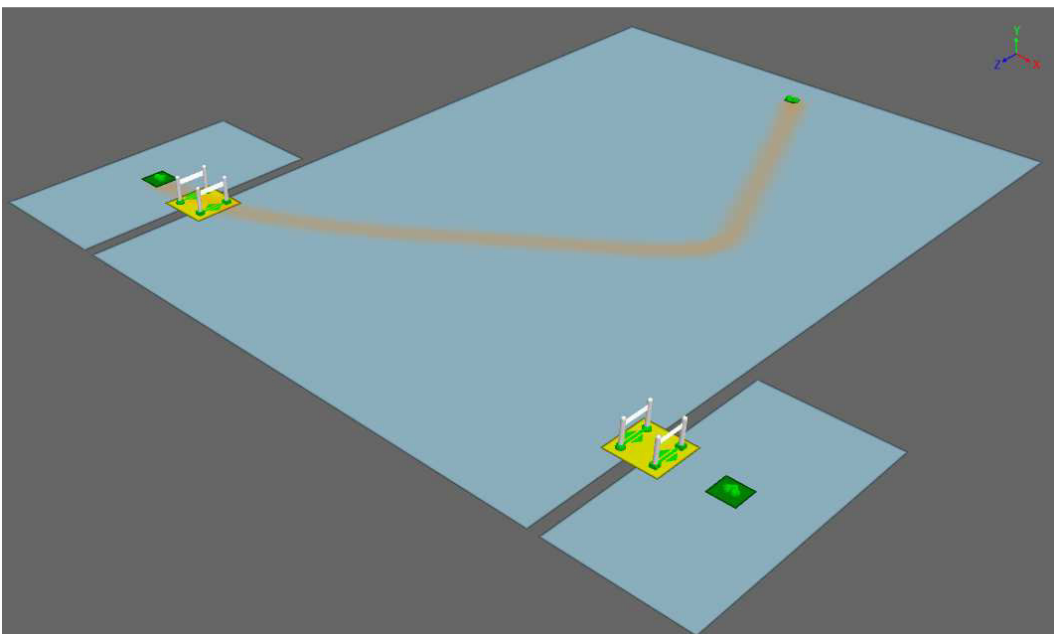

Figure A13.4: Predicted Agent Route Map for Scenario 2 (Exit 1 Closed at 6s)

The agent route map predictions are consistent with anticipated behaviours.

A13.5 Conclusion

NIST 1822 Test 3.3 has been conducted within MassMotion.

Results from the test indicate MassMotion is able to reproduce the results stated in the NIST guidance given the configured parameters of the model.

Status: Pass.

A14 Test 15: Stair Merging

A14.1 Test Description

This test investigates the ability of MassMotion to represent:

- the merging of flows in a stairwell; and
- to assess the effect of occupant densities on the merging of flows in a stairwell.

The test is based on a 3-storey building (with open plan floor plates) and a single dog-leg stair accessed via landings, as illustrated in Figure A14.1.

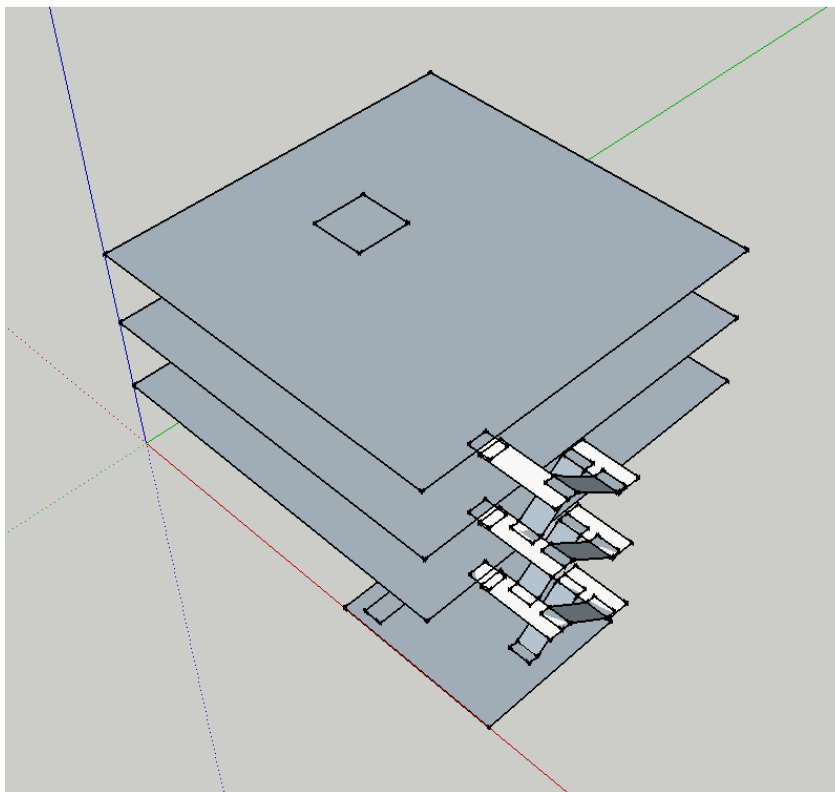

Figure A14.1: Geometric Layout

Table A14.1. summarises the floor occupancies for each of the five scenarios considered in this study.

Scenario	Occupancy (agents)		
	1 st Floor	2 nd Floor	3 rd Floor
1	100	0	0
2	100	100	0
3	100	400	0
4	100	600	0
5	100	200	200

Table A14.1: Floor Occupancies

A14.2 Aim of Test

The purpose of the test is to verify that MassMotion is able to represent the merging of flows at an entry point on the stair.

A14.3 Simulation Setup

The MassMotion model geometry includes:

- Three 20.0m x 20.0m upper floors and a 9.0m x 7.8m ground floor.
- 1.0m wide stair entry doors at the three upper floors.
- Stairs:
 - 1.2m wide with flights spanning 2.5m horizontally;
 - 4.0m x 1.2m landings at each floor;
 - 3.0m x 1.2m half-landings.
- Entry portals on the three upper floors.
- A 6.5m long exit portal at ground floor level.

(See Figures A14.2 to A14.4.)

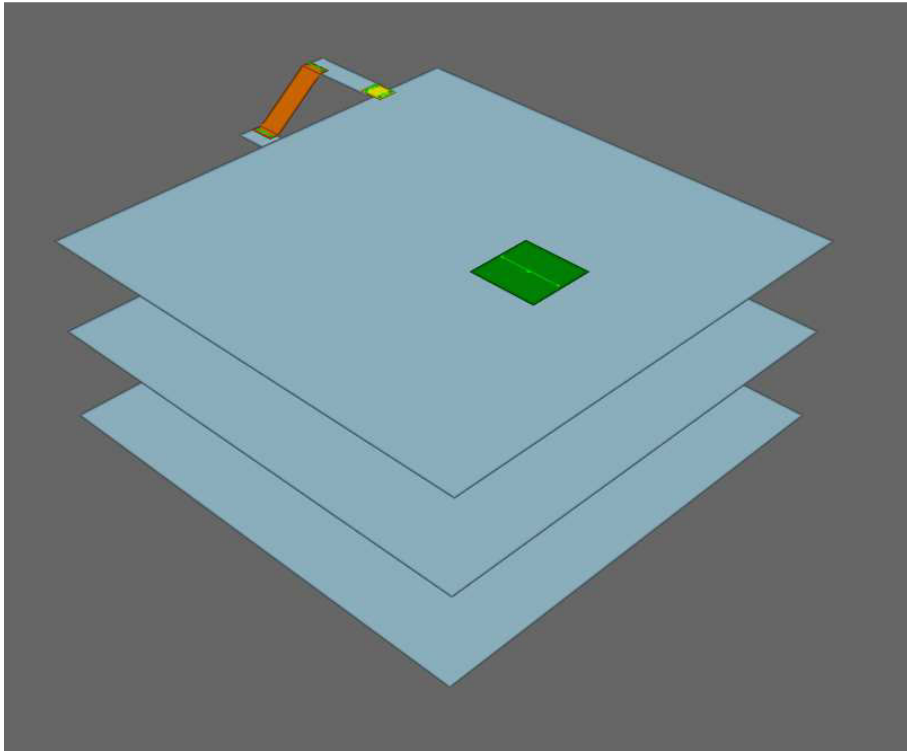

Figure A14.2: MassMotion Physical Environment

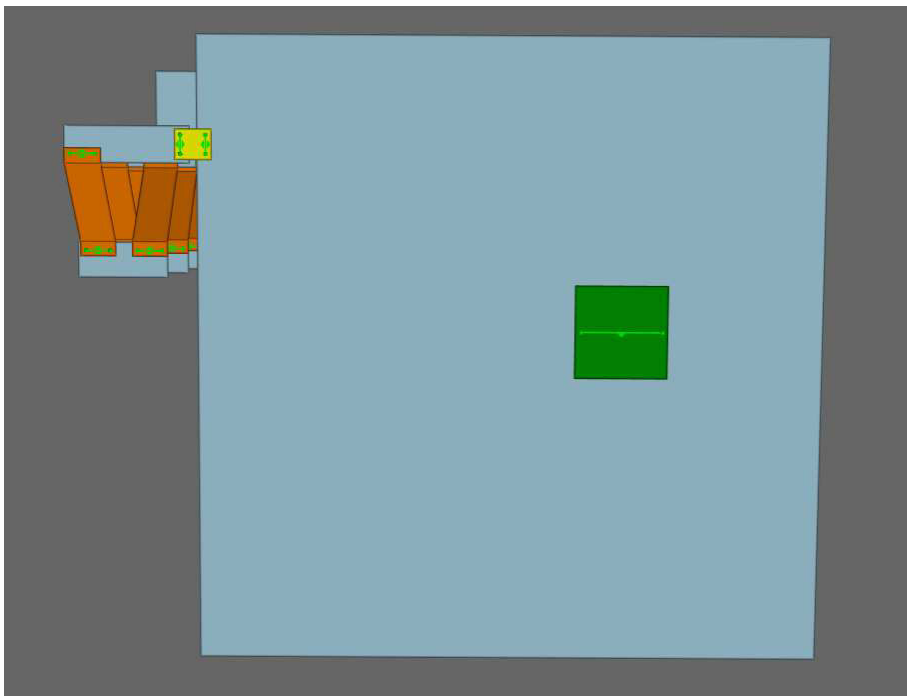

Figure A14.3: MassMotion Physical Environment

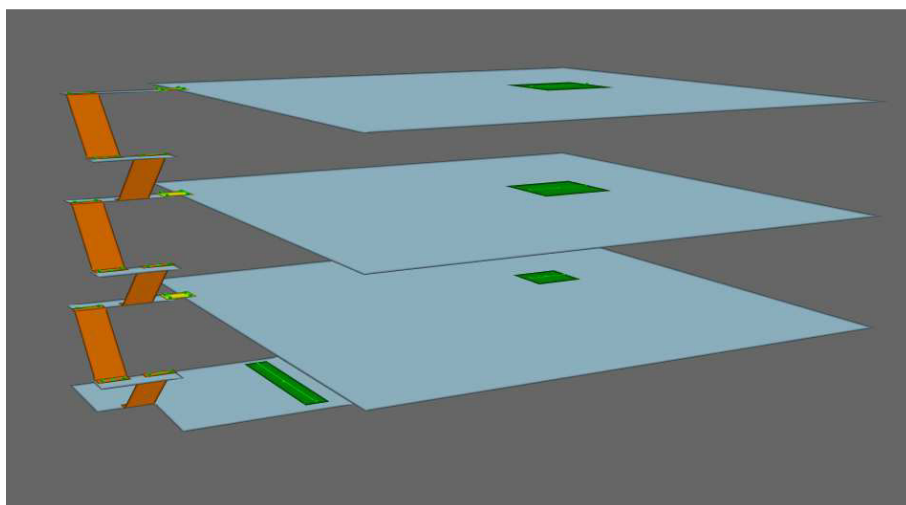

Figure A14.4: MassMotion Physical Environment

The entry portals on each floor were defined so that the agents were randomly distributed across the whole floor plate (rather than within a bounding area of the floor plate).

The default agent attributes (e.g. preferred horizontal terrain walking speed) and zero pre-evacuation times were assigned to all the agents. 'Evacuation' events were created for the agents of each individual floor.

(See Figures A14.5 to A14.8.)



Figure A14.5: Agent Profile

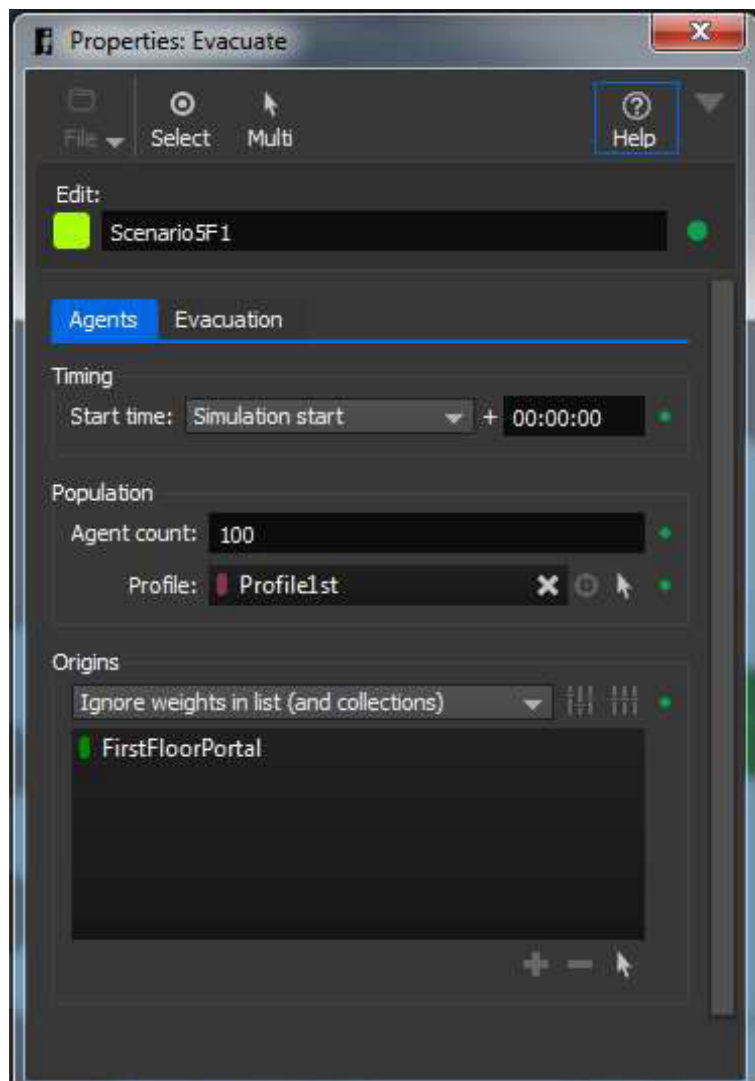

Figure A14.6: Evacuation Event – Agents Origination on First Floor

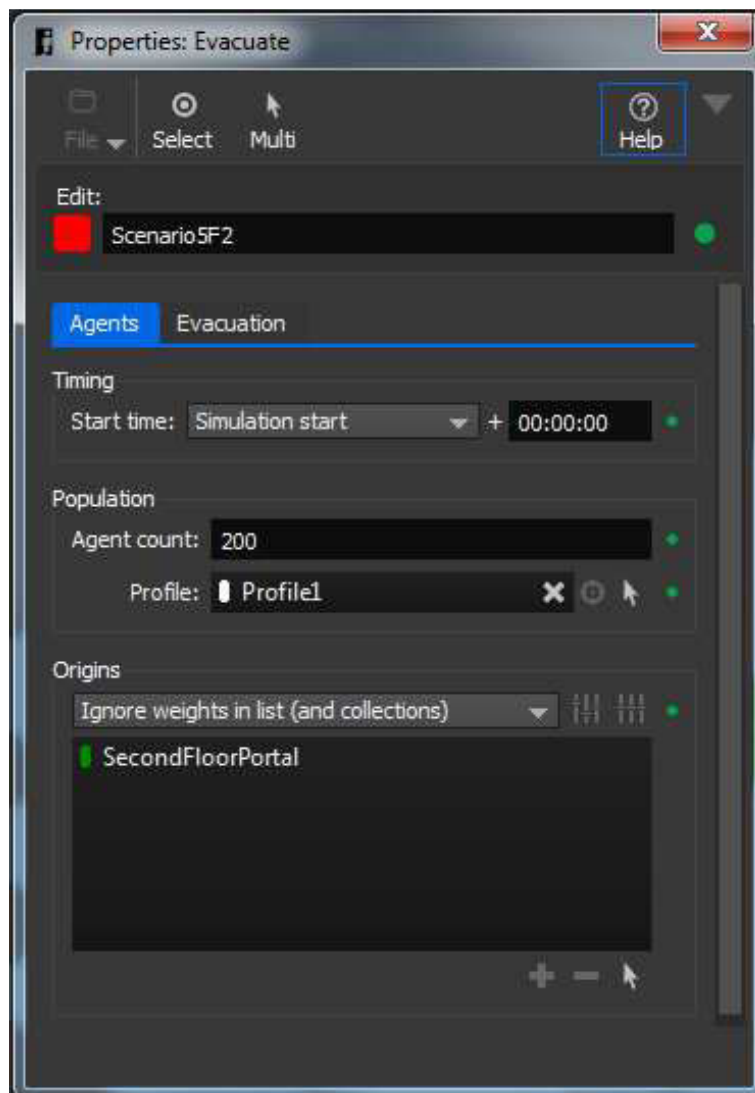

Figure A14.7: Evacuation Event – Agents Origination on Second Floor

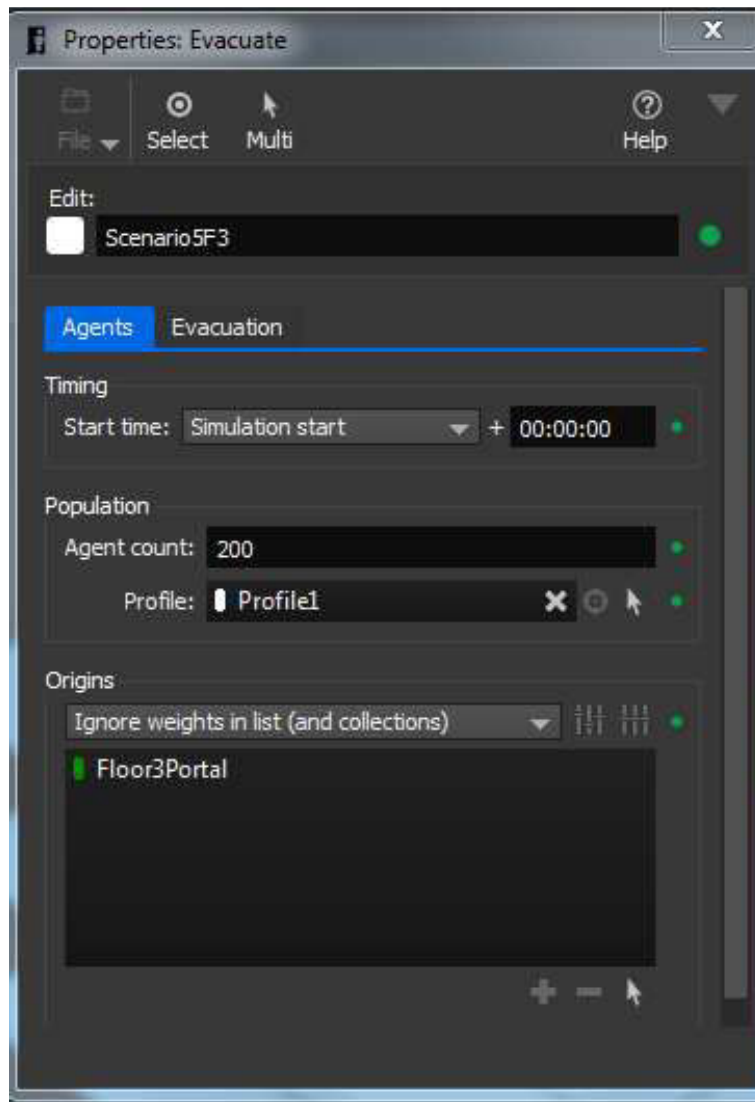

Figure A14.8: Evacuation Event – Agents Origination on Third Floor

A14.4 Test Results

Scenario 1 illustrates the use of stairs without merging flows, Figure A14.9.

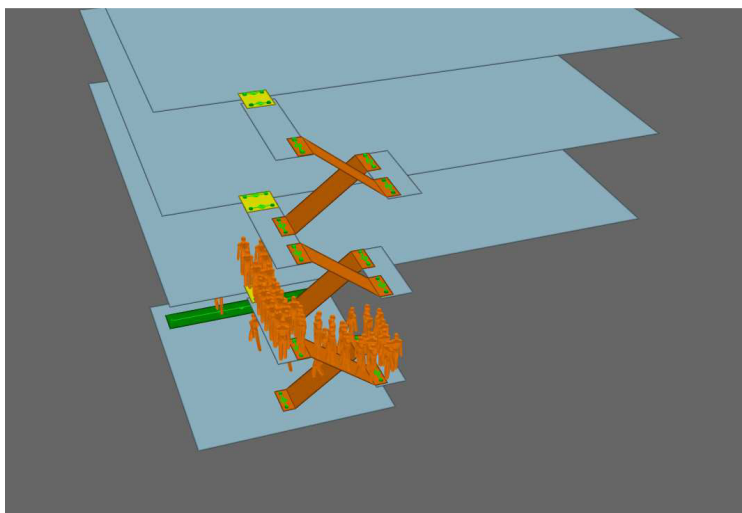

Figure A14.9: Scenario 1 – Stair Use Without Merging Flows

The time taken for the agents to clear the first floor is predicted to be 82s.

Scenarios 2, 3 and 4 investigate the effect that the occupancy of the second floor has on the ability of occupants on the first floor to enter the stair. Table A14.2 summarises the MassMotion predictions.

Scenario	First Floor Clearance		
	Time (seconds)	% Change Compared to Scenario 1	% Change Compared to Scenario 2
1	82	N/A	N/A
2	123	151.2	N/A
3	116	141.4	93.5
4	115	140.2	92.7
5	117	142.7	N/A

Table A14.2: First Floor Clearing Times

Scenario 5 is undertaken to establish if there is any impact on the merging flows if merging occurs on multiple floors (Figure A14.10).

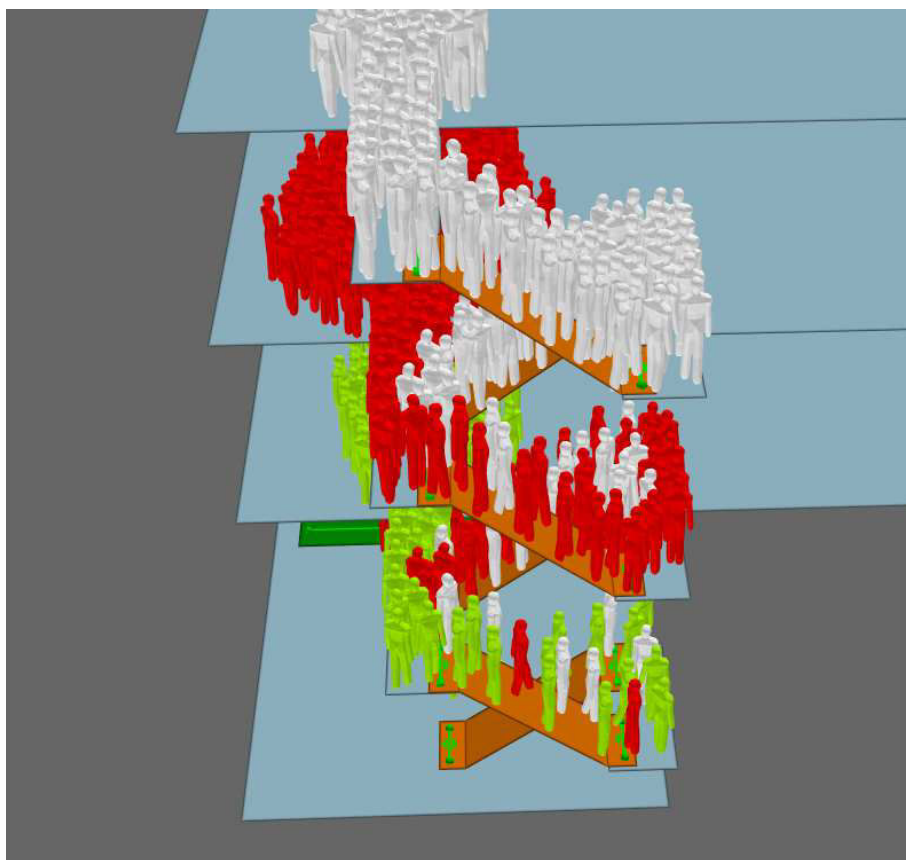

Figure A14.10: Scenario 5 – Merging Flows

It was considered likely that the predictions would be dominated by queuing behaviour on the stairs (and, therefore, that the effect of random sampling on the prediction would not be significant). Only a single simulation was undertaken for each scenario.

Results – Scenarios 2, 3 and 4

The time taken for the agents to clear the first floor is increased substantially when agents are introduced to the second floor.

Increasing the number of agents on the second floor (from 100 agents to 400 agents or 600 agents) has little impact on the time taken for the agents to evacuate from the first floor. This suggests that when a stair is fully utilised, merging (between the stream entering the stair and those already on the stair) occurs at a ratio of approximately 1:1 (in the configuration examined in this test – further testing is required to examine whether this rule holds in all cases).

Results – Scenario 5

The time required for the agents to evacuate from the first floor is 117s, i.e. similar to that for Scenarios 2, 3 and 4. It can be concluded that multiple floor merging flows does not affect the merging flow behaviour.

A14.5 Conclusion

This test examined merging flows in a stairwell within MassMotion. It may be concluded that:

- merging flows can be represented in MassMotion;
- the delay to agents exiting a floor as a result of agents on the stair from a floor(s) above (and, by inference, the delay to agents on the stair as a result of agents entering from a floor below) can be represented by MassMotion; and
- for the configuration under consideration in this test, that when a stair is fully utilised, merging (between the stream entering the stair and those already on the stair) occurs at a ratio of approximately 1:1.

Status: Pass.

A15 Test 16: Stair Flows

A15.1 Test Description

This test investigates the flow rates on (downward and upward) stairs, with the aim of confirming that an increase in stair width leads to an increase in agent flow rate.

Two floors are connected by a stair (height = 3.00m; diagonal = 4.24m; angle = 45°). Five stair widths (1.0m, 1.2m, 1.4m, 1.6m and 1.8m) are considered (Figure A15.1).

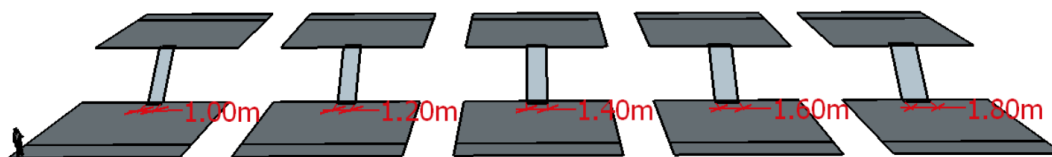

Figure A15.1: Geometric Layout and Stair Widths

Two scenarios are considered:

- **Scenario 1** (Stair Down) – flow from the upper floor to the lower floor.
- **Scenario 2** (Stair Up) – flow from the lower floor to the upper floor.

The study utilises 100 agents (for each scenario / stair width combination) to estimate the flow rates on the stairs.

A15.2 Aim of Test

The purpose of this test is to verify that MassMotion predicts an increase in agent flow rate as the stair width increases.

A15.3 Simulation Setup

The MassMotion geometry, for both scenarios, consists of:

- 5 stairs (as described in Section A15.1);
- 5 upper floors (one per stair) each with an entry / exit portal;
- 5 lower floors (one per stair) each with an exit / entry portal.

MassMotion default properties were adopted for the floors, stairs and portals. (See Figure A15.2.)

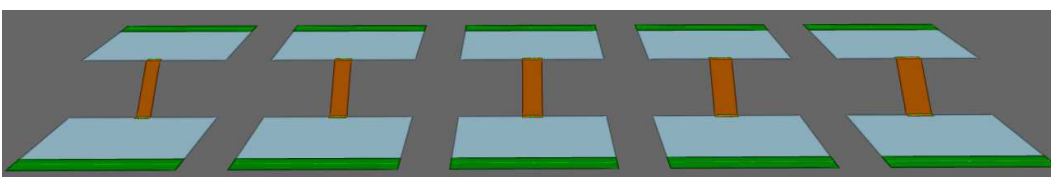

Figure A15.2: MassMotion Physical Environment

The MassMotion default agent attributes were applied to each of the 100 agents utilised in the simulation of each scenario / stair width combination.

'Evacuation' events were created for each stair configuration:

- Scenario 1 (Stair Down) simulations define the entry portal to be on the upper floor and the exit portal to be on the corresponding lower floor.
- Scenario 2 (Stair Up) simulations define the entry portal to be on the lower floor and the exit portal to be on the corresponding upper floor.

For all 'Evacuation' events, the start time for the agent population was 0s after the simulation start; with a 2s pre-evacuation time.

The occupant flow rates are measured at the point where the agents enter the stairs (i.e. at the top in Scenario 1 (flow from the upper floor to the lower floor) and at the bottom in Scenario 2 (flow from the lower floor to the upper floor)).

A15.4 Test Results

Scenario 1 (Stair Down)

Figure A15.3 shows the agent population and instantaneous density at 30 seconds after the start of the simulation (with the stair width increasing from left (1.0m) to right (1.8m)).

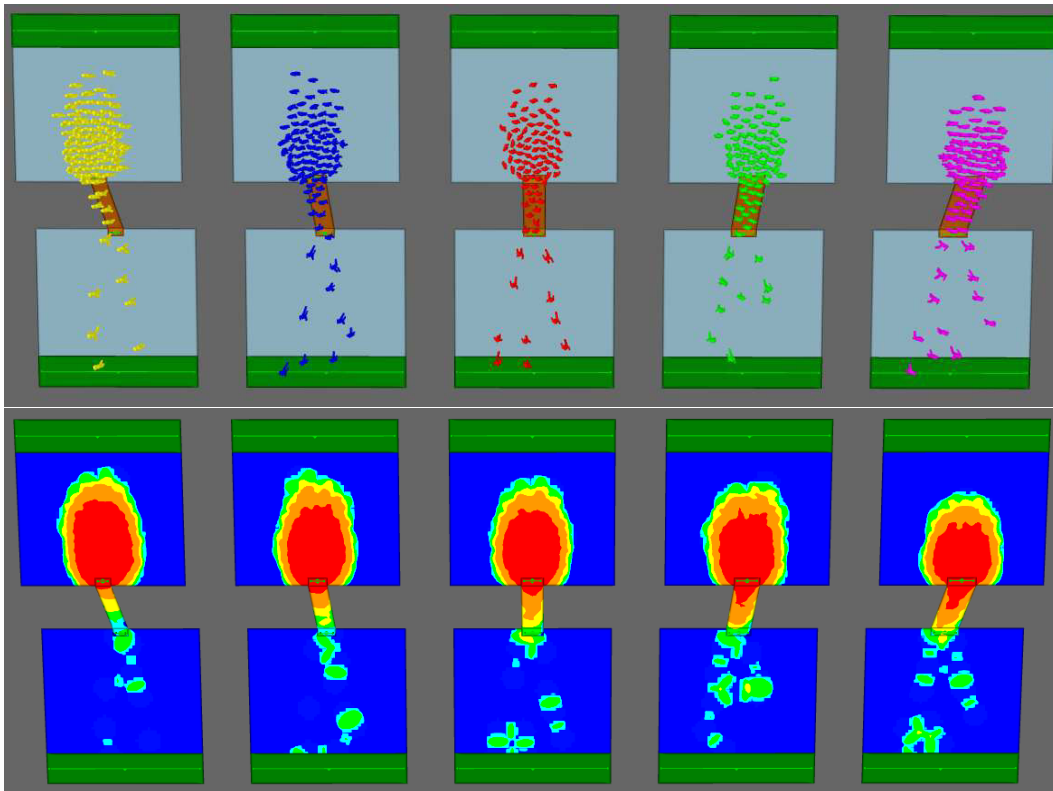

Figure A15.3: Scenario 1 (Stair Down) – Agent Population and Instantaneous Density at 30s

The upper floor clearance times are summarised in Table A15.1.

Time (s)	Observation
0	Simulation start.
10	Agents entered all stairs.
61	Upper floor of 1800mm stair cleared.
74	Upper floor of 1600mm stair cleared.
80	Upper floor of 1400mm stair cleared.
90	Upper floor of 1200mm stair cleared.
117	Upper floor of 1000mm stair cleared.

Table A15.1: Scenario 1 (Stair Down) – Observations

The agent flow rate through each stair as a function of time is illustrated in Figure A15.4. It is calculated by time-averaging the number of agents entering the stairs at one second intervals

starting when the first agent enters the corresponding stair. As may be observed from the figure, there are initial ‘spikes’ in the flow rates. This is a function of the time averaging within the flow rate calculation rather than caused by the actual ‘spikes’ in the flow rate of agents through the monitoring location. (A description of this feature of MassMotion is provided in Section A3.4.)

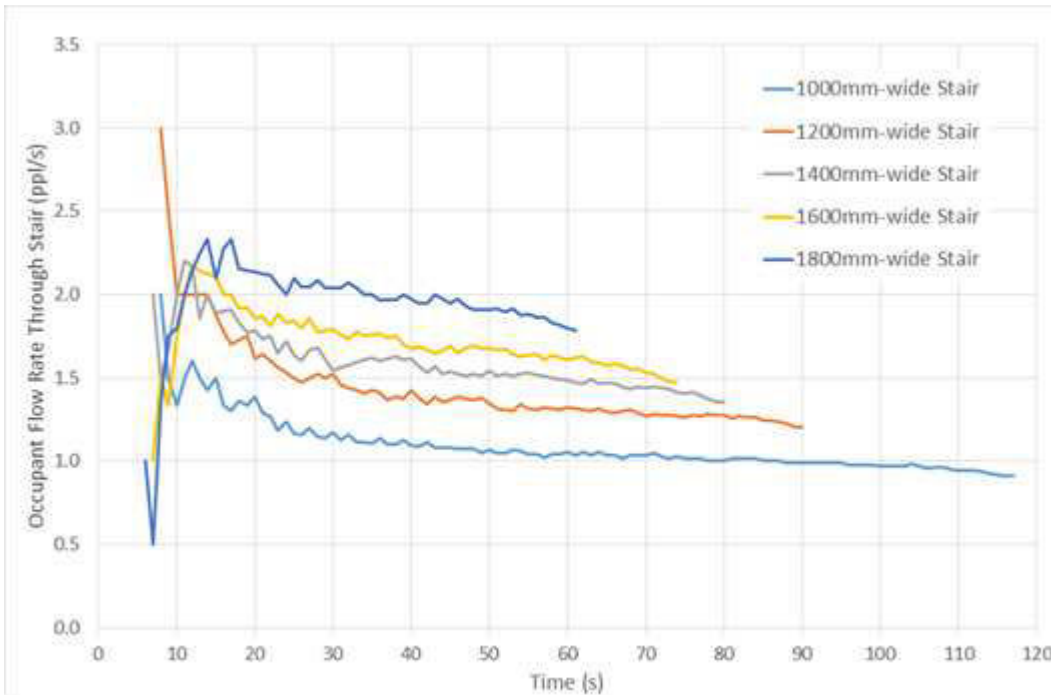

Figure A15.4: Scenario 1 (Stair Down) – Flow Rate Through the Stair

Moving averages and overall averages of the flow rates through all the stairs are presented in Table A15.2.

Time Frame	Average Flow (people/s) Through Stair				
	1.0m	1.2m	1.4m	1.6m	1.8m
Moving Average Start to Finish (0s to 117s)	1.09	1.45	1.60	1.71	1.94
Moving Average Time for Consistent Flow (25s to 117s)	1.03	1.34	1.51	1.66	1.95
Overall Average (Total Occupancy / Total Exit Time)	0.85	1.11	1.25	1.35	1.64
Expected Total Flow Rate Based on an Average Flow Rate per Unit Width of 1.1people/m/s	1.10	1.32	1.54	1.76	1.98

Table A15.2: Scenario 1 (Stair Down) – Average Agent Flow Rates Through the Stair

The 'Moving Average – Time for Consistent Flow' is calculated excluding the spikes from the beginning or the simulation. Assuming an approximately linear relationship between this average and the stair width, then the average flow rate per unit on the stair is estimated as 1.1 people/m/s (i.e. 66people/m/min). This is within the maximum flow rate downstairs reported by Fruin [5][6] of approximately 69people/m/min.

The last row on Table A15.2 shows the expected flow rates when based on the average flow rate per unit of 1.1 people/m/s, which can be compared to the 'Moving Average – Time for Consistent Flow'.

Scenario 2 (Stair Up)

Figure A15.5 shows the agent population and instantaneous density at 30 seconds after the start of the simulation (with the stair width increasing from left (1.0m) to right (1.8m)).

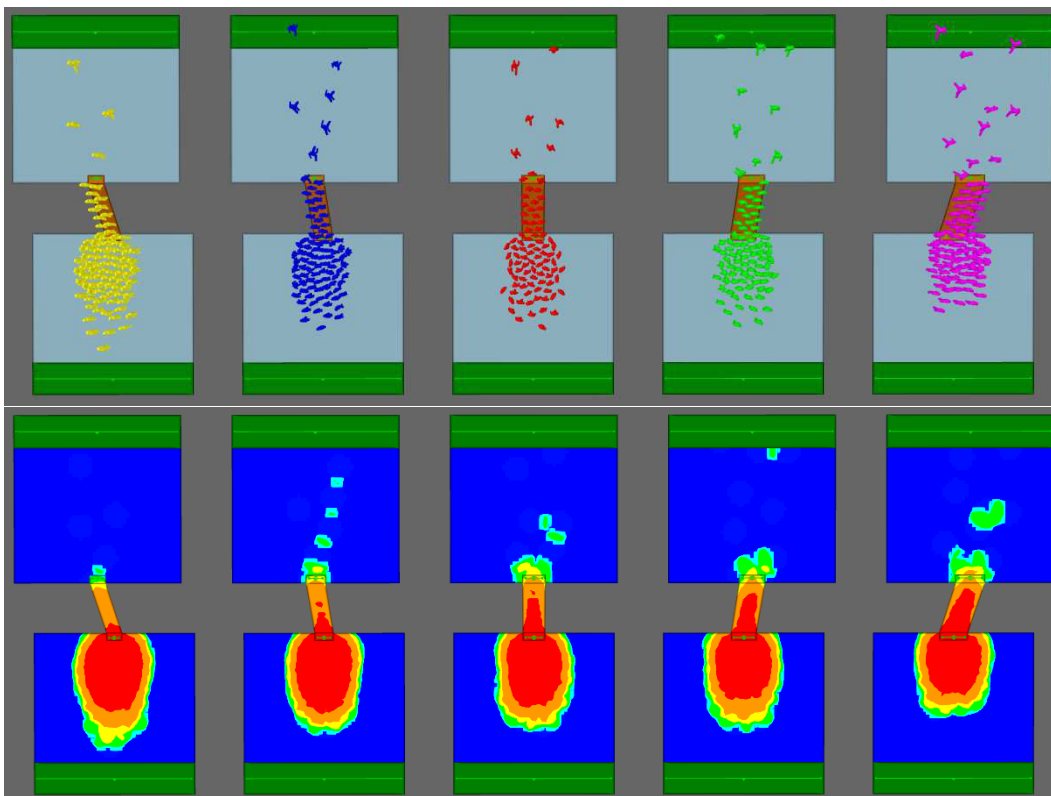

Figure A15.5: Scenario 2 (Stair Up) – Agent Population and Instantaneous Density at 30s

The lower floor clearance times are summarised in Table A15.3.

Time (s)	Observation
0	Simulation start.
7	Agents entered all stairs.
67	Lower floor of 1800mm stair cleared.
77	Lower floor of 1600mm stair cleared.
84	Lower floor of 1400mm stair cleared.
95	Lower floor of 1200mm stair cleared.
116	Lower floor of 1000mm stair cleared.

Table A15.3: Scenario 2 (Stair Up) – Observations

Similar to the downstairs case, the agent flow rate through each stair as a function of time is illustrated in Figure A15.6.

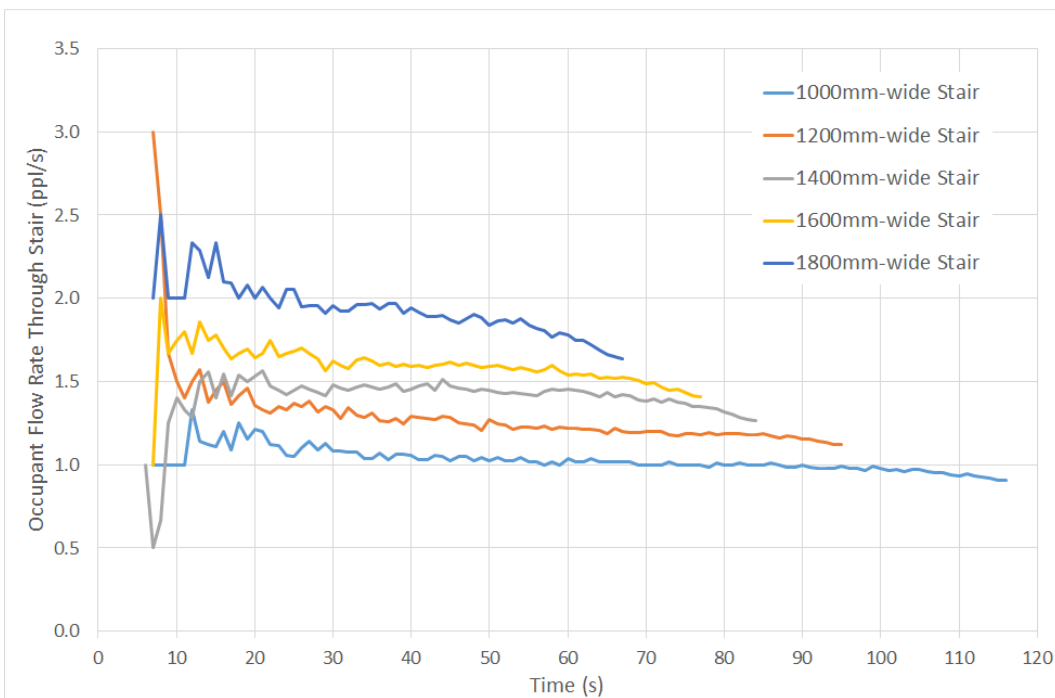

Figure A15.5: Scenario 2 (Stair Up) – Flow Rate Through the Stair

The moving average and overall average is reported in Table A15.4.

Time Frame	Average Flow (people/s) Through Stair				
	1.0m	1.2m	1.4m	1.6m	1.8m
Moving Average Start to Finish (0s to 116s)	1.03	1.30	1.40	1.60	1.94
Moving Average Time for Consistent Flow (25s to 116s)	1.01	1.23	1.42	1.57	1.86
Overall Average (Total Occupancy / Total Exit Time)	0.86	1.05	1.19	1.30	1.49
Expected Total Flow Rate Based on an Average Flow Rate per Unit Width of 1.0people/m/s	1.00	1.20	1.40	1.60	1.80

Table A15.4: Scenario 2 (Stair Up) – Average Agent Flow Rates Through the Stair

As with the downstairs case, the ‘Moving Average – Time for Consistent Flow’ is calculated excluding the spikes from the beginning of the simulation. Assuming an approximately linear relationship between this average and the stair width, then the average flow rate per unit of width is estimated as 1.0people/m/s (i.e. 60people/m/min). This is within the maximum flow rate upstairs reported by Fruin [5][6] of approximately 62 people/m/min.

The last row on Table A15.4 shows the expected flow rates when based on the average flow rate per unit of 1.0 people/m/s, which can be compared to the ‘Moving Average – Time for Consistent Flow’.

A15.5 Conclusion

This test examined flows in (downward and upward) stairs within MassMotion. It may be concluded that:

- the predicted agent flow rate increases almost linearly with increase in stair width for a fully utilised stair with the agents moving down – a normalised agent flow rate of 1.1people/m/s is estimated from these results;
- the predicted agent flow rate increases almost linearly with increase in stair width for a fully utilised stair with the agents moving up – a normalised agent flow rate of 1.0people/m/m is estimated from these results.

Status: Pass.