

LS-DYNA®
KEYWORD USER'S MANUAL

VOLUME II
Material Models

R14@ad6b3a9c5 (02/24/23)
LS-DYNA R14

ANSYS

Websites

<https://lsdyna.ansys.com>
<https://support.ansys.com>

Disclaimer

Copyright © 1992-2023 ANSYS, Inc (“ANSYS”). All Rights Reserved.

LS-DYNA®, LS-OPT® and LS-PrePost® are registered trademarks of ANSYS. All other trademarks, product names and brand names belong to their respective owners.

LST reserves the right to modify the material contained within this manual without prior notice.

The information and examples included herein are for illustrative purposes only and are not intended to be exhaustive or all-inclusive. ANSYS assumes no liability or responsibility whatsoever for any direct or indirect damages or inaccuracies of any type or nature that could be deemed to have resulted from the use of this manual.

Any reproduction, in whole or in part, of this manual is prohibited without the prior written approval of ANSYS. All requests to reproduce the contents hereof should be sent to Ansys legal.

AES Licensing Terms

Copyright © 2001, Dr Brian Gladman <brg@gladman.uk.net>, Worcester, UK. All rights reserved.

The free distribution and use of this software in both source and binary form is allowed (with or without changes) provided that:

1. distributions of this source code include the above copyright notice, this list of conditions and the following disclaimer;
2. distributions in binary form include the above copyright notice, this list of conditions and the following disclaimer in the documentation and/or other associated materials;
3. the copyright holder's name is not used to endorse products built using this software without specific written permission.

DISCLAIMER

This software is provided 'as is' with no explicit or implied warranties in respect of any properties, including, but not limited to, correctness and fitness for purpose.

Issue Date: 21/01/2002

This file contains the code for implementing the key schedule for AES (Rijndael) for block and key sizes of 16, 24, and 32 bytes.

TABLE OF CONTENTS

TABLE OF CONTENTS

TABLE OF CONTENTS	0-1
*EOS.....	1-1
*EOS_LINEAR_POLYNOMIAL	1-7
*EOS_JWL.....	1-9
*EOS_SACK_TUESDAY	1-14
*EOS_GRUNEISEN	1-15
*EOS_RATIO_OF_POLYNOMIALS	1-17
*EOS_LINEAR_POLYNOMIAL_WITH_ENERGY_LEAK	1-21
*EOS_IGNITION_AND_GROWTH_OF_REACTION_IN_HE.....	1-23
*EOS_TABULATED_COMPACTION	1-27
*EOS_TABULATED	1-30
*EOS_PROPELLANT_DEFLAGRATION.....	1-32
*EOS_TENSOR_PORE_COLLAPSE	1-37
*EOS_IDEAL_GAS.....	1-40
*EOS_PHASE_CHANGE	1-42
*EOS_JWLB	1-44
*EOS_GASKET	1-47
*EOS_MIE_GRUNEISEN	1-50
*EOS_MURNAGHAN	1-52
*EOS_USER_DEFINED	1-53
*EOS_USER_LIBRARY	1-54
*MAT.....	2-1
MATERIAL MODEL REFERENCE TABLES	2-10
Alphabetized Materials List.....	2-22
*MAT_ADD_AIRBAG_POROSITY_LEAKAGE.....	2-34
*MAT_ADD_CHEM_SHRINKAGE	2-42
*MAT_ADD_COHESIVE.....	2-44
*MAT_ADD_DAMAGE_DIEM	2-48
*MAT_ADD_DAMAGE_GISSMO	2-62
*MAT_ADD_EROSION	2-74
*MAT_ADD_FATIGUE	2-83
*MAT_ADD_GENERALIZED_DAMAGE.....	2-89
*MAT_ADD_INELASTICITY	2-101

TABLE OF CONTENTS

*MAT_ADD_PERMEABILITY	2-118
*MAT_ADD_PORE_AIR	2-120
*MAT_ADD_PROPERTY_DEPENDENCE	2-123
*MAT_ADD_PZELECTRIC	2-125
*MAT_ADD_SOC_EXPANSION	2-129
*MAT_ADD_THERMAL_EXPANSION	2-131
*MAT_NONLOCAL	2-133
*MAT_ELASTIC	2-137
*MAT_OPTIONTROPIC_ELASTIC	2-140
*MAT_PLASTIC_KINEMATIC	2-155
*MAT_ELASTIC_PLASTIC_THERMAL	2-158
*MAT_SOIL_AND_FOAM	2-161
*MAT_VISCOELASTIC	2-165
*MAT_BLATZ-KO_RUBBER	2-167
*MAT_HIGH_EXPLOSIVE_BURN	2-169
*MAT_NULL	2-172
*MAT_ELASTIC_PLASTIC_HYDRO	2-174
*MAT_STEINBERG	2-180
*MAT_STEINBERG_LUND	2-185
*MAT_ISOTROPIC_ELASTIC_PLASTIC	2-189
*MAT_ISOTROPIC_ELASTIC_FAILURE	2-190
*MAT_SOIL_AND_FOAM_FAILURE	2-192
*MAT_JOHNSON_COOK	2-193
*MAT_PSEUDO_TENSOR	2-203
*MAT_ORIENTED_CRACK	2-211
*MAT_POWER_LAW_PLASTICITY	2-214
*MAT_STRAIN_RATE_DEPENDENT_PLASTICITY	2-216
*MAT_RIGID	2-219
*MAT_ORTHOTROPIC_THERMAL	2-227
*MAT_COMPOSITE_DAMAGE	2-236
*MAT_TEMPERATURE_DEPENDENT_ORTHOTROPIC	2-243
*MAT_PIECEWISE_LINEAR_PLASTICITY	2-249
*MAT_GEOLOGIC_CAP_MODEL	2-256
*MAT_HONEYCOMB	2-262
*MAT_MOONEY-RIVLIN_RUBBER	2-270
*MAT_RESULTANT_PLASTICITY	2-274
*MAT_FORCE_LIMITED	2-275

TABLE OF CONTENTS

*MAT_SHAPE_MEMORY	2-282
*MAT_FRAZER_NASH_RUBBER_MODEL	2-288
*MAT_LAMINATED_GLASS	2-292
*MAT_BARLAT_ANISOTROPIC_PLASTICITY	2-294
*MAT_BARLAT_YLD96	2-299
*MAT_FABRIC	2-304
*MAT_FABRIC_MAP	2-331
*MAT_PLASTIC_GREEN-NAGHDI_RATE	2-345
*MAT_3-PARAMETER_BARLAT	2-346
*MAT_EXTENDED_3-PARAMETER_BARLAT	2-367
*MAT_TRANSVERSELY_ANISOTROPIC_ELASTIC_PLASTIC	2-372
*MAT_BLATZ-KO_FOAM	2-379
*MAT_FLD_TRANSVERSELY_ANISOTROPIC	2-381
*MAT_NONLINEAR_ORTHOTROPIC	2-383
*MAT_USER_DEFINED_MATERIAL_MODELS	2-389
*MAT_BAMMAN	2-396
*MAT_BAMMAN_DAMAGE	2-401
*MAT_CLOSED_CELL_FOAM	2-404
*MAT_ENHANCED_COMPOSITE_DAMAGE	2-407
*MAT_LOW_DENSITY_FOAM	2-424
*MAT_LAMINATED_COMPOSITE_FABRIC	2-429
*MAT_COMPOSITE_FAILURE	2-448
*MAT_ELASTIC_WITH_VISCOSITY	2-455
*MAT_ELASTIC_WITH_VISCOSITY_CURVE	2-458
*MAT_KELVIN-MAXWELL_VISCOELASTIC	2-461
*MAT_VISCOUS_FOAM	2-463
*MAT_CRUSHABLE_FOAM	2-465
*MAT_RATE_SENSITIVE_POWERLAW_PLASTICITY	2-470
*MAT_MODIFIED_ZERILLI_ARMSTRONG	2-473
*MAT_LINEAR_ELASTIC_DISCRETE_BEAM	2-476
*MAT_NONLINEAR_ELASTIC_DISCRETE_BEAM	2-479
*MAT_NONLINEAR_PLASTIC_DISCRETE_BEAM	2-485
*MAT_SID_DAMPER_DISCRETE_BEAM	2-493
*MAT_HYDRAULIC_GAS_DAMPER_DISCRETE_BEAM	2-498
*MAT_CABLE_DISCRETE_BEAM	2-500
*MAT_CONCRETE_DAMAGE	2-503
*MAT_CONCRETE_DAMAGE_REL3	2-508

TABLE OF CONTENTS

*MAT_LOW_DENSITY_VISCOUS_FOAM	2-517
*MAT_ELASTIC_SPRING_DISCRETE_BEAM.....	2-523
*MAT_BILKHU/DUBOIS_FOAM.....	2-525
*MAT_GENERAL_VISCOELASTIC	2-528
*MAT_HYPERELASTIC_RUBBER.....	2-534
*MAT_OGDEN_RUBBER	2-546
*MAT_SOIL_CONCRETE	2-553
*MAT_HYSTERETIC_SOIL	2-557
*MAT_RAMBERG-OSGOOD	2-566
*MAT_PLASTICITY_WITH_DAMAGE.....	2-568
*MAT_FU_CHANG_FOAM	2-577
*MAT_WINFRITH_CONCRETE	2-589
*MAT_WINFRITH_CONCRETE_REINFORCEMENT	2-594
*MAT_ORTHOTROPIC_VISCOELASTIC.....	2-596
*MAT_CELLULAR_RUBBER.....	2-599
*MAT_MTS	2-604
*MAT_PLASTICITY_POLYMER.....	2-609
*MAT_ACOUSTIC	2-613
*MAT_ACOUSTIC_COMPLEX	2-615
*MAT_ACOUSTIC_DAMP	2-617
*MAT_ACOUSTIC_POROUS_DB	2-619
*MAT_SOFT_TISSUE	2-621
*MAT_ELASTIC_6DOF_SPRING_DISCRETE_BEAM	2-628
*MAT_INELASTIC_SPRING_DISCRETE_BEAM	2-630
*MAT_INELASTIC_6DOF_SPRING_DISCRETE_BEAM.....	2-633
*MAT_BRITTLE_DAMAGE	2-635
*MAT_GENERAL_JOINT_DISCRETE_BEAM.....	2-639
*MAT_SIMPLIFIED_JOHNSON_COOK	2-641
*MAT_SIMPLIFIED_JOHNSON_COOK_ORTHOTROPIC_DAMAGE.....	2-644
*MAT_SPOTWELD	2-646
*MAT_SPOTWELD_DAIMLERCHRYSLER	2-671
*MAT_GEPLASTIC_SRATE_2000a	2-676
*MAT_INV_HYPERBOLIC_SIN.....	2-678
*MAT_ANISOTROPIC_VISCOPLASTIC	2-682
*MAT_ANISOTROPIC_PLASTIC	2-691
*MAT_DAMAGE_1.....	2-695
*MAT_DAMAGE_2.....	2-706

TABLE OF CONTENTS

*MAT_ELASTIC_VISCOPLASTIC_THERMAL	2-711
*MAT_MODIFIED_JOHNSON_COOK	2-716
*MAT_ORTHO_ELASTIC_PLASTIC	2-726
*MAT_JOHNSON_HOLMQUIST_CERAMICS	2-731
*MAT_JOHNSON_HOLMQUIST_CONCRETE	2-735
*MAT_FINITE_ELASTIC_STRAIN_PLASTICITY	2-738
*MAT_TRIP	2-741
*MAT_LAYERED_LINEAR_PLASTICITY	2-745
*MAT_UNIFIED_CREEP	2-749
*MAT_UNIFIED_CREEP_ORTHO	2-751
*MAT_COMPOSITE_LAYUP	2-756
*MAT_COMPOSITE_MATRIX	2-759
*MAT_COMPOSITE_DIRECT	2-762
*MAT_GENERAL_NONLINEAR_6DOF_DISCRETE_BEAM	2-764
*MAT_GURSON	2-780
*MAT_GURSON_JC	2-787
*MAT_GURSON_RCDC	2-796
*MAT_GENERAL_NONLINEAR_1DOF_DISCRETE_BEAM	2-802
*MAT_HILL_3R	2-805
*MAT_HILL_3R_3D	2-809
*MAT_HILL_3R_TABULATED	2-816
*MAT_MODIFIED_PIECEWISE_LINEAR_PLASTICITY	2-819
*MAT_PLASTICITY_COMPRESSION_TENSION	2-828
*MAT_KINEMATIC_HARDENING_TRANSVERSELY_ANISOTROPIC	2-834
*MAT_MODIFIED_HONEYCOMB	2-841
*MAT_ARRUDA_BOYCE_RUBBER	2-856
*MAT_HEART_TISSUE	2-859
*MAT_LUNG_TISSUE	2-864
*MAT_SPECIAL_ORTHOTROPIC	2-867
*MAT_ISOTROPIC_SMEARED_CRACK	2-871
*MAT_ORTHOTROPIC_SMEARED_CRACK	2-874
*MAT_BARLAT_YLD2000	2-879
*MAT_VISCOELASTIC_FABRIC	2-894
*MAT_WTM_STM	2-898
*MAT_WTM_STM_PLC	2-910
*MAT_VEGTER	2-915
*MAT_VEGTER_STANDARD	2-922

TABLE OF CONTENTS

*MAT_VEGTER_2017	2-929
*MAT_COHESIVE_MIXED_MODE	2-935
*MAT_MODIFIED_FORCE_LIMITED	2-940
*MAT_VACUUM	2-954
*MAT_RATE_SENSITIVE_POLYMER.....	2-955
*MAT_TRANSVERSELY_ISOTROPIC_CRUSHABLE_FOAM	2-957
*MAT_WOOD	2-962
*MAT_PITZER_CRUSHABLE_FOAM.....	2-973
*MAT_SCHWER_MURRAY_CAP_MODEL	2-975
*MAT_1DOF_GENERALIZED_SPRING.....	2-983
*MAT_FHWA_SOIL	2-985
*MAT_FHWA_SOIL_NEBRASKA	2-988
*MAT_GAS_MIXTURE.....	2-989
*MAT_EMMI	2-996
*MAT_DAMAGE_3.....	2-1004
*MAT_DESHPANDE_FLECK_FOAM.....	2-1017
*MAT_PLASTICITY_COMPRESSION_TENSION_EOS.....	2-1020
*MAT_MUSCLE.....	2-1026
*MAT_ANISOTROPIC_ELASTIC_PLASTIC.....	2-1030
*MAT_RATE_SENSITIVE_COMPOSITE_FABRIC	2-1045
*MAT_CSCM.....	2-1052
*MAT_ALE_INCOMPRESSIBLE.....	2-1065
*MAT_COMPOSITE_MSC.....	2-1067
*MAT_MODIFIED_CRUSHABLE_FOAM	2-1080
*MAT_BRAIN_LINEAR_VISCOELASTIC	2-1083
*MAT_PLASTIC_NONLINEAR_KINEMATIC	2-1085
*MAT_MOMENT_CURVATURE_BEAM	2-1087
*MAT_MCCORMICK.....	2-1091
*MAT_POLYMER	2-1094
*MAT_ARUP_ADHESIVE.....	2-1099
*MAT_RESULTANT_ANISOTROPIC.....	2-1110
*MAT_STEEL_CONCENTRIC_BRACE.....	2-1114
*MAT_CONCRETE_EC2	2-1121
*MAT_MOHR_COULOMB.....	2-1144
*MAT_RC_BEAM.....	2-1151
*MAT_VISCOELASTIC_THERMAL.....	2-1157
*MAT_QUASILINEAR_VISCOELASTIC.....	2-1162

TABLE OF CONTENTS

*MAT_HILL_FOAM	2-1167
*MAT_VISCOELASTIC_HILL_FOAM.....	2-1171
*MAT_LOW_DENSITY_SYNTHETIC_FOAM.....	2-1176
*MAT_SIMPLIFIED_RUBBER/FOAM.....	2-1182
*MAT_SIMPLIFIED_RUBBER_WITH_DAMAGE.....	2-1191
*MAT_COHESIVE_ELASTIC	2-1194
*MAT_COHESIVE_TH	2-1196
*MAT_COHESIVE_GENERAL	2-1200
*MAT_SAMP-1	2-1205
*MAT_SAMP_LIGHT	2-1215
*MAT_THERMO_ELASTO_VISCOPLASTIC_CREEP.....	2-1221
*MAT_ANISOTROPIC_THERMOELASTIC.....	2-1227
*MAT_FLD_3-PARAMETER_BARLAT.....	2-1231
*MAT_SEISMIC_BEAM	2-1237
*MAT_SOIL_BRICK.....	2-1247
*MAT_DRUCKER_PRAGER.....	2-1255
*MAT_RC_SHEAR_WALL	2-1259
*MAT_CONCRETE_BEAM	2-1267
*MAT_GENERAL_SPRING_DISCRETE_BEAM.....	2-1270
*MAT_SEISMIC_ISOLATOR.....	2-1275
*MAT_JOINTED_ROCK.....	2-1287
*MAT_BARLAT_YLD2004	2-1293
*MAT_STEEL_EC3	2-1298
*MAT_HYSTERETIC_REINFORCEMENT.....	2-1301
*MAT_DISCRETE_BEAM_POINT_CONTACT.....	2-1308
*MAT_SOIL_SANISAND.....	2-1314
*MAT_BOLT_BEAM	2-1322
*MAT_HYSTERETIC_BEAM.....	2-1329
*MAT_SPR_JLR	2-1349
*MAT_COMPOSITE_TABULATED_PLASTICITY_DAMAGE.....	2-1358
*MAT_DRY_FABRIC.....	2-1392
*MAT_4A_MICROMECH	2-1400
*MAT_ELASTIC_PHASE_CHANGE	2-1412
*MAT_ORTHOTROPIC_ELASTIC_PHASE_CHANGE.....	2-1414
*MAT_MOONEY-RIVLIN_PHASE_CHANGE.....	2-1419
*MAT_CODAM2	2-1424
*MAT_RIGID_DISCRETE.....	2-1437

TABLE OF CONTENTS

*MAT_ORTHOTROPIC_SIMPLIFIED_DAMAGE	2-1438
*MAT_TABULATED_JOHNSON_COOK	2-1449
*MAT_TABULATED_JOHNSON_COOK_GYS_{OPTION}	2-1457
*MAT_VISCOPLASTIC_MIXED_HARDENING	2-1462
*MAT_KINEMATIC_HARDENING_BARLAT89	2-1464
*MAT_PML_ELASTIC	2-1470
*MAT_PML_ELASTIC_FLUID	2-1472
*MAT_PML_ACOUSTIC	2-1473
*MAT_BIOT_HYSTERETIC	2-1475
*MAT_CAZACU_BARLAT	2-1477
*MAT_VISCOELASTIC_LOOSE_FABRIC	2-1492
*MAT_MICROMECHANICS_DRY_FABRIC	2-1498
*MAT_SCC_ON_RCC	2-1504
*MAT_PML_HYSTERETIC	2-1508
*MAT_PERT_PIECEWISE_LINEAR_PLASTICITY	2-1509
*MAT_COHESIVE_MIXED_MODE_ELASTOPLASTIC_RATE	2-1510
*MAT_JOHNSON_HOLMQUIST_JH1	2-1523
*MAT_KINEMATIC_HARDENING_BARLAT2000	2-1527
*MAT_HILL_90	2-1534
*MAT_UHS_STEEL	2-1545
*MAT_PML_OPTIONTROPIC_ELASTIC	2-1567
*MAT_PML_NULL	2-1571
*MAT_PHS_BMW	2-1573
*MAT_REINFORCED_THERMOPLASTIC	2-1594
*MAT_REINFORCED_THERMOPLASTIC_CRASH	2-1605
*MAT_REINFORCED_THERMOPLASTIC_UDFIBER	2-1620
*MAT_TAILORED_PROPERTIES	2-1627
*MAT_TOUGHENED_ADHESIVE_POLYMER	2-1631
*MAT_GENERALIZED_PHASE_CHANGE	2-1639
*MAT_PIECEWISE_LINEAR_PLASTIC_THERMAL	2-1657
*MAT_AMORPHOUS_SOLIDS_FINITE_STRAIN	2-1660
*MAT_NON_QUADRATIC_FAILURE	2-1663
*MAT_STOUGHTON_NON_ASSOCIATED_FLOW	2-1667
*MAT_MOHR_NON_ASSOCIATED_FLOW	2-1678
*MAT_LAMINATED_FRACTURE_DAIMLER_PINHO	2-1692
*MAT_LAMINATED_FRACTURE_DAIMLER_CAMANHO	2-1706
*MAT_LOU-YOON_ANISOTROPIC_PLASTICITY	2-1721

TABLE OF CONTENTS

*MAT_TABULATED_JOHNSON_COOK_ORTHO_PLASTICITY	2-1729
*MAT_CONSTRAINED	2-1738
*MAT_TISSUE_DISPERSED	2-1745
*MAT_EIGHT_CHAIN_RUBBER.....	2-1753
*MAT_BERGSTROM_BOYCE_RUBBER	2-1765
*MAT_CWM.....	2-1768
*MAT_POWDER	2-1774
*MAT_RHT.....	2-1782
*MAT_CONCRETE_DAMAGE_PLASTIC_MODEL	2-1791
*MAT_PAPER	2-1799
*MAT_SMOOTH_VISCOELASTIC_VISCOPLASTIC	2-1810
*MAT_CHRONOLOGICAL_VISCOELASTIC	2-1818
*MAT_ADHESIVE_CURING_VISCOELASTIC	2-1821
*MAT_CF_MICROMECHANICS.....	2-1825
*MAT_COHESIVE_PAPER	2-1832
*MAT_GLASS.....	2-1837
*MAT_SHAPE_MEMORY_ALLOY.....	2-1846
*MAT_ELASTIC_PERI	2-1857
*MAT_ELASTIC_PERI_LAMINATE.....	2-1858
*MAT_COMPRF	2-1860
*MAT_ANISOTROPIC_HYPERELASTIC	2-1866
*MAT_ANAND_VISCOPLASTICITY.....	2-1885
*MAT_DMN_COMPOSITE_FRC	2-1888
*MAT_HOT_PLATE_ROLLING	2-1903
*MAT_GENERALIZED_ADHESIVE_CURING	2-1912
*MAT_IFPD.....	2-1932
*MAT_COHESIVE_GASKET	2-1933
*MAT_ALE_VACUUM.....	2-1937
*MAT_ALE_GAS_MIXTURE	2-1938
*MAT_ALE_VISCOUS	2-1939
*MAT_ALE_MIXING_LENGTH.....	2-1942
*MAT_ALE_INCOMPRESSIBLE.....	2-1945
*MAT_ALE_HERSCHEL	2-1946
*MAT_SPH_VISCOUS.....	2-1949
*MAT_SPH_INCOMPRESSIBLE_FLUID	2-1953
*MAT_SPH_INCOMPRESSIBLE_STRUCTURE.....	2-1955
*MAT_SPRING_ELASTIC.....	2-1957

TABLE OF CONTENTS

*MAT_DAMPER_VISCOUS	2-1958
*MAT_SPRING_ELASTOPLASTIC	2-1959
*MAT_SPRING_NONLINEAR_ELASTIC	2-1960
*MAT_DAMPER_NONLINEAR_VISCOUS.....	2-1961
*MAT_SPRING_GENERAL_NONLINEAR	2-1962
*MAT_SPRING_MAXWELL	2-1965
*MAT_SPRING_INELASTIC	2-1967
*MAT_SPRING_TRILINEAR_DEGRADING	2-1968
*MAT_SPRING_SQUAT_SHEARWALL.....	2-1969
*MAT_SPRING_MUSCLE	2-1970
*MAT_SEATBELT	2-1975
*MAT_THERMAL.....	3-1
*MAT_THERMAL_ISOTROPIC.....	3-2
*MAT_THERMAL_ORTHOTROPIC	3-4
*MAT_THERMAL_ISOTROPIC_TD	3-7
*MAT_THERMAL_ORTHOTROPIC_TD.....	3-9
*MAT_THERMAL_DISCRETE_BEAM.....	3-14
*MAT_THERMAL_CHEMICAL_REACTION.....	3-15
*MAT_THERMAL_CWM.....	3-25
*MAT_THERMAL_ORTHOTROPIC_TD_LC	3-28
*MAT_THERMAL_ISOTROPIC_PHASE_CHANGE	3-34
*MAT_THERMAL_ISOTROPIC_TD_LC.....	3-37
*MAT_THERMAL_USER_DEFINED	3-41
*MAT_THERMAL_CHEMICAL_REACTION_ORTHOTROPIC.....	3-44

*EOS

When defining an equation of state, the type of equation of state is specified by a corresponding 3-digit number in the command name, e.g., *EOS_004, or equivalently, by its more descriptive designation, e.g., *EOS_GRUNEISEN. The equations of state can be used with a subset of the materials that are available for solid elements; see the MATERIAL MODEL REFERENCE TABLES in the beginning of the *MAT section of this Manual. *EOS_015 is linked to the type 2 thick shell element and can be used to model engine gaskets.

The meaning associated with particular extra history variables for a subset of material models and equations of state are tabulated at <http://www.dynasupport.com/howto-/material/history-variables>. The first three extra history variables when using an equation of state are (1) internal energy, (2) pressure due to bulk viscosity, and (3) the element volume from the previous time step.

TYPE 1:	*EOS_LINEAR_POLYNOMIAL
TYPE 2:	*EOS_JWL
TYPE 3:	*EOS_SACK_TUESDAY
TYPE 4:	*EOS_GRUNEISEN
TYPE 5:	*EOS_RATIO_OF_POLYNOMIALS
TYPE 6:	*EOS_LINEAR_POLYNOMIAL_WITH_ENERGY_LEAK
TYPE 7:	*EOS_IGNITION_AND_GROWTH_OF_REACTION_IN_HE
TYPE 8:	*EOS_TABULATED_COMPACTION
TYPE 9:	*EOS_TABULATED
TYPE 10:	*EOS_PROPELLANT_DEFLAGRATION
TYPE 11:	*EOS_TENSOR_PORE_COLLAPSE
TYPE 12:	*EOS_IDEAL_GAS
TYPE 13:	*EOS_PHASE_CHANGE
TYPE 14:	*EOS_JWLB

*EOS

TYPE 15:	*EOS_GASKET
TYPE 16:	*EOS_MIE_GRUNEISEN
TYPE 19:	*EOS_MURNAGHAN
TYPE 21-30:	*EOS_USER_DEFINED

An additional option **TITLE** may be appended to all the *EOS keywords. If this option is used then an additional line is read for each section in 80a format which can be used to describe the equation of state. At present LS-DYNA does not make use of the title. Inclusion of title simply gives greater clarity to input decks.

Definitions and Conventions

In order to prescribe the boundary and/or initial thermodynamic condition, manual computations are often necessary. Conventions or definitions must be established to simplify this process. Some basic variables are defined in the following. Since many of these variables have already been denoted by different symbols, the notations used here are unique in this section only! They are presented to only clarify their usage. A corresponding SI unit set is also presented as an example.

First consider a few volumetric parameters since they are a measure of compression (or expansion).

Volume:

$$V \approx (\text{m}^3)$$

Mass:

$$M \approx (\text{Kg})$$

Current specific volume (per mass):

$$v = \frac{V}{M} = \frac{1}{\rho} \approx \left(\frac{\text{m}^3}{\text{Kg}} \right)$$

Reference specific volume:

$$v_0 = \frac{V_0}{M} = \frac{1}{\rho_0} \approx \left(\frac{\text{m}^3}{\text{Kg}} \right)$$

Relative volume:

$$v_r = \frac{V}{V_0} = \frac{(V/M)}{(V_0/M)} = \frac{v}{v_0} = \frac{\rho_0}{\rho}$$

Current normalized volume increment:

$$\frac{dv}{v} = \frac{v - v_0}{v} = 1 - \frac{1}{v_r} = 1 - \frac{\rho}{\rho_0}$$

A frequently used volumetric parameter is:

$$\mu = \frac{1}{v_r} - 1 = \frac{v_0 - v}{v} = -\frac{dv}{v} = \frac{\rho}{\rho_0} - 1$$

Sometimes another volumetric parameter is used:

$$\eta = \frac{v_0}{v} = \frac{\rho}{\rho_0}$$

Thus, the relation between μ and η is,

$$\mu = \frac{v_0 - v}{v} = \eta - 1$$

The following table summarizes these volumetric parameters.

VARIABLES	COMPRESSION	NO LOAD	EXPANSION
$v_r = \frac{v}{v_0} = \frac{\rho_0}{\rho}$	< 1	1	> 1
$\eta = \frac{1}{v_r} = \frac{v_0}{v} = \frac{\rho}{\rho_0}$	> 1	1	< 1
$\mu = \frac{1}{v_r} - 1 = \eta - 1$	> 0	0	< 0

V0 – Initial Relative Volume

There are 3 definitions of density that must be distinguished from each other:

$$\begin{aligned} \rho_0 &= \rho_{\text{ref}} \\ &= \text{Density at nominal/reference state, usually non-stress or non-deformed state.} \\ \rho|_{t=0} &= \text{Density at time 0} \\ \rho &= \text{Current density} \end{aligned}$$

Recalling the current relative volume

$$v_r = \frac{\rho_0}{\rho} = \frac{v}{v_0},$$

at time = 0 the relative volume is

$$v_{r0} = v_r|_{t=0} = \frac{\rho_0}{\rho|_{t=0}} = \frac{v|_{t=0}}{v_0}.$$

*EOS

Generally, the V0 input parameter in an *EOS card refers to this v_{r0} . ρ_0 is generally the density defined in the *MAT card. Hence, if a material is mechanically compressed at $t = 0$, V0, or v_{r0} , the initial relative volume, may be computed and input accordingly ($v_0 \neq V0$).

The “reference” state is a unique state with respect to which the material stress tensor is computed. Therefore v_0 is very critical in computing the pressure level in a material. Incorrect choice of v_0 would lead to incorrect pressure computed. In general, v_0 is chosen such that at zero compression or expansion, the material should be in equilibrium with its ambient surrounding. In many of the equations shown in the EOS section, μ is frequently used as a measure of compression (or expansion). However, the users must clearly distinguish between μ and v_{r0} .

E0 – Internal Energy

Internal energy represents the thermal energy state (temperature dependent component) of a system. One definition for internal energy is

$$E = MC_vT \approx (\text{Joule})$$

Note that the capital “E” here is the absolute internal energy. It is not the same as that used in the subsequent *EOS keyword input, or some equations shown for each *EOS card. This internal energy is often defined with respect to a mass or volume unit.

Internal energy per unit mass (also called specific internal energy):

$$e = \frac{E}{M} = C_vT \approx \left(\frac{\text{Joule}}{\text{Kg}} \right)$$

Internal energy per unit current volume:

$$e_V = \frac{M}{V} C_vT = \rho C_vT = \frac{C_vT}{v} \approx \left(\frac{\text{Joule}}{\text{m}^3} = \frac{\text{N}}{\text{m}^2} \right)$$

Internal energy per unit reference volume:

$$e_{V_0} = \frac{M}{V_0} C_vT = \rho_0 C_vT = \frac{C_vT}{v_0} \approx \left(\frac{\text{Joule}}{\text{m}^3} = \frac{\text{N}}{\text{m}^2} \right)$$

e_{V_0} typically refers to the capital “E” shown in some equations under this “EOS” section. Hence the initial “*internal energy per unit reference volume*”, E0, a keyword input parameter in the *EOS section can be computed from

$$e_{V_0}|_{t=0} = \rho_0 C_vT|_{t=0}$$

To convert from e_{V_0} to e_V , simply divide e_{V_0} by v_r

$$e_V = \rho C_vT = [\rho_0 C_vT] \frac{\rho}{\rho_0} = \frac{e_{V_0}}{v_r}$$

Equations of States (EOS)

A thermodynamic state of a homogeneous material, not undergoing any chemical reactions or phase changes, may be defined by two state variables. This relation is generally called an equation of state. For example, a few possible forms relating pressure to two other state variables are

$$P = P(\rho, T) = P(v, e) = P(v_r, e_V) = P(\mu, e_{V_0})$$

The last equation form is frequently used to compute pressure. The EOS for solid phase materials is sometimes partitioned into 2 terms, a cold pressure and a thermal pressure

$$P = P_c(\mu) + P_T(\mu, e_{V_0})$$

$P_c(\mu)$ is the cold pressure hypothetically evaluated along a 0-degree-Kelvin isotherm. This is sometimes called a 0-K pressure-volume relation or cold compression curve. $P_T(\mu, e_{V_0})$ is the thermal pressure component that depends on both volumetric compression and thermal state of the material.

Different forms of the EOS describe different types of materials and how their volumetric compression (or expansion) behaviors. The coefficients for each EOS model come from data-fitting, phenomenological descriptions, or derivations based on classical thermodynamics, etc.

Linear Compression

In low pressure processes, pressure is not significantly affected by temperature. When volumetric compression is within an elastic linear deformation range, a linear bulk modulus may be used to relate volume changes to pressure changes. Recalling the definition of an isotropic bulk modulus is [Fung 1965],

$$\frac{\Delta v}{v} = -\frac{P}{K}$$

This may be rewritten as

$$P = K \left[-\frac{\Delta v}{v} \right] = K\mu.$$

The bulk modulus, K , thus is equivalent to C_1 in *EOS_LINEAR_POLYNOMIAL when all other coefficients are zero. This is a simplest form of an EOS. To initialize a pressure for such a material, only v_{r_0} must be defined.

Initial Conditions

In general, a thermodynamic state must be defined by two state variables. The need to specify v_{r_0} and/or $e_{V_0}|_{t=0}$ depends on the form of the EOS chosen. The user should review the equation term-by-term to establish what parameters to be initialized.

*EOS

For many of the EOS available, pressure is specified (given), and the user must make an assumption on either $e_{V_0}|_{t=0}$ or v_{r_0} . Consider two possibilities (1) $T|_{t=0}$ is defined or assumed from which $e_{V_0}|_{t=0}$ may be computed, or (2) $\rho|_{t=0}$ is defined or assumed from which v_{r_0} may be obtained.

When to Use EOS

For small strains considerations, a total stress tensor may be partitioned into a deviatoric stress component and a mechanical pressure.

$$\sigma_{ij} = \sigma'_{ij} + \frac{\sigma_{kk}}{3} \delta_{ij} = \sigma'_{ij} - P \delta_{ij}$$
$$P = -\frac{\sigma_{kk}}{3}$$

The pressure component may be written from the diagonal stress components.

Note that $\frac{\sigma_{kk}}{3} = \frac{[\sigma_{11} + \sigma_{22} + \sigma_{33}]}{3}$ is positive in tension while P is positive in compression.

Similarly, the total strain tensor may be partitioned into a deviatoric strain component (volume-preserving deformation) and a volumetric deformation.

$$\varepsilon_{ij} = \varepsilon'_{ij} + \frac{\varepsilon_{kk}}{3} \delta_{ij}$$

where $\frac{\varepsilon_{kk}}{3}$ is called the mean normal strain, and ε_{kk} is called the dilatation or volume strain (change in volume per unit initial volume)

$$\varepsilon_{kk} = \frac{V - V_0}{V_0}$$

Roughly speaking, a typical convention may refer to the relation $\sigma'_{ij} = f(\varepsilon'_{ij})$ as a “constitutive equation”, and $P = f(\mu, e_{V_0})$ as an EOS. The use of an EOS may be omitted only when volumetric deformation is very small, and $|P| \ll |\sigma'_{ij}|$.

A Note About Contact When Using an Equation of State

When a part includes an equation of state, it is important that the initial geometry of that part not be perturbed by the contact algorithm. Such perturbation can arise due to initial penetrations in the contact surfaces but can usually be avoided by setting the variable IGNORE to 1 or 2 in the *CONTACT input or by using a segment based contact (SOFT = 2).

***EOS_LINEAR_POLYNOMIAL**

This is Equation of State Form 1.

Purpose: Define coefficients for a linear polynomial EOS, and initialize the thermodynamic state of the material by defining E0 and V0 below.

Card 1	1	2	3	4	5	6	7	8
Variable	EOSID	C0	C1	C2	C3	C4	C5	C6
Type	A	F	F	F	F	F	F	F

Card 2	1	2	3	4	5	6	7	8
Variable	E0	V0						
Type	F	F						

VARIABLE**DESCRIPTION**

EOSID	Equation of state ID. A unique number or label must be specified (see *PART).
C0	The 0 th polynomial equation coefficient
C1	The 1 st polynomial equation coefficient (when used by itself, this is the <i>elastic</i> bulk modulus, meaning it cannot be used for deformation that is beyond the elastic regime).
⋮	⋮
C6	The 6 th polynomial equation coefficient
E0	Initial internal energy per unit reference volume (see the beginning of the *EOS section)
V0	Initial relative volume (see the beginning of the *EOS section)

Remarks:

1. **Pressure.** The linear polynomial equation of state is linear in internal energy. The pressure is given by:

$$P = C_0 + C_1\mu + C_2\mu^2 + C_3\mu^3 + (C_4 + C_5\mu + C_6\mu^2)E.$$

where terms $C_2\mu^2$ and $C_6\mu^2$ are set to zero if $\mu < 0$, $\mu = \rho/\rho_0 - 1$, and ρ/ρ_0 is the ratio of current density to reference density. ρ is a nominal or reference density defined in the *MAT_NULL card.

The linear polynomial equation of state may be used to model gas with the gamma law equation of state. This may be achieved by setting:

$$C_0 = C_1 = C_2 = C_3 = C_6 = 0$$

and

$$C_4 = C_5 = \gamma - 1$$

where

$$\gamma = \frac{C_p}{C_v}$$

is the ratio of specific heats. Pressure for a perfect gas is then given by:

$$P = (\gamma - 1) \frac{\rho}{\rho_0} E = (\gamma - 1) \frac{e_{V_0}}{v_r}$$

E has the units of pressure (where $E = e_{V_0}$ and $v_r = \rho_0/\rho$).

2. **Initial Pressure.** When $C_0 = C_1 = C_2 = C_3 = C_6 = 0$, it does not necessarily mean that the initial pressure is zero ($P_0 \neq C_0!$). The initial pressure depends on the values of all the coefficients and on $\mu|_{t=0}$ and $E|_{t=0}$. The pressure in a material is computed from the whole equation above, $P = P(\mu, E)$. It is always preferable to initialize the initial condition based on $\mu|_{t=0}$ and $E|_{t=0}$. The use of $C_0 = C_1 = C_2 = C_3 = C_6 = 0$ must be done with caution as it may change the form and behavior of the material. The safest way is to use the whole EOS equation to manually check for the pressure value. For example, for an ideal gas, only C_4 and C_5 are nonzero; C_4 and C_5 are equal to $\gamma - 1$ while all other coefficients (C_0, C_1, C_2, C_3 , and C_6) are zero to satisfy the perfect gas equation form.
3. **V0 and E0.** V0 and E0 defined in this card must be the same as the time-zero ordinates for the 2 load curves defined in the *BOUNDARY_AMBIENT_EOS card, if it is used. This is so that they would both consistently define the same initial state for a material.

*EOS_JWL_{OPTION}

This is Equation of State Form 2.

Available options are:

<BLANK>

AFTERBURN

Card Summary:

Card 1. This card is required.

EOSID	A	B	R1	R2	OMEG	E0	V0
-------	---	---	----	----	------	----	----

Card 2a. This card is included if and only if the AFTERBURN keyword option is used and OPT = 1 or 2.

OPT	QT	T1	T2				
-----	----	----	----	--	--	--	--

Card 2b. This card is included if and only if the AFTERBURN keyword option is used and OPT = 3.

OPT	Q0	QA	QM	QN	CONM	CONL	CONT
-----	----	----	----	----	------	------	------

Data Card Definitions:

Card 1	1	2	3	4	5	6	7	8
Variable	EOSID	A	B	R1	R2	OMEG	E0	V0
Type	A	F	F	F	F	F	F	F

VARIABLE

DESCRIPTION

EOSID	Equation of state ID. A unique number or label must be specified (see *PART).
A	A, see Remarks.
B	B, see Remarks.
R1	R ₁ , see Remarks.

VARIABLE	DESCRIPTION
R2	R_2 , see Remarks.
OMEG	ω , see Remarks.
E0	Detonation energy per unit volume and initial value for E . See Remarks.
V0	Initial relative volume, which gives the initial value for V . See Remarks.

Afterburn Card. Additional card for AFTERBURN option with OPT = 1 or 2.

Card 2a	1	2	3	4	5	6	7	8
Variable	OPT	QT	T1	T2				
Type	F	F	F	F				

VARIABLE	DESCRIPTION
OPT	Afterburn option: EQ.0.0: No afterburn energy (Standard *EOS_JWL) EQ.1.0: Constant rate of afterburn energy added between times T1 and T2 EQ.2.0: Linearly increasing rate of afterburn energy added between times T1 and T2 EQ.3.0: Miller's extension for afterburn energy
QT	Afterburn energy per unit volume for simple afterburn
T1	Start time of energy addition for simple afterburn
T2	End time of energy addition for simple afterburn

Afterburn Card. Additional card for AFTERBURN option with OPT = 3.

Card 2b	1	2	3	4	5	6	7	8
Variable	OPT	Q0	QA	QM	QN	CONM	CONL	CONT
Type	F	F	F	F	F	F	F	F
Default	none	none	none	0.5	1/6	1.	1.	1.

VARIABLE**DESCRIPTION**

OPT	<p>Afterburn option</p> <p>EQ.0.0: No afterburn energy (Standard *EOS_JWL)</p> <p>EQ.1.0: Constant rate of afterburn energy added between times T1 and T2</p> <p>EQ.2.0: Linearly increasing rate of afterburn energy added between times T1 and T2</p> <p>EQ.3.0: Miller's extension for afterburn energy</p>
Q0	Afterburn energy per unit volume for Miller's extension
QA	Energy release constant a for Miller's extension
QM	Energy release exponent m for Miller's extension
QN	Pressure exponent n for Miller's extension
CONM	<p>Mass Conversion factors:</p> <p>GT.0.0: Mass conversion factor from model units to calibration units for Miller's extension</p> <p>LT.0.0: Use predefined factors to convert model units to published calibration units of g, cm, μs. Choices for model units are:</p> <p>EQ.-1.0: g, mm, ms</p> <p>EQ.-2.0: g, cm, ms</p> <p>EQ.-3.0: kg, m, s</p> <p>EQ.-4.0: kg, mm, ms</p> <p>EQ.-5.0: metric ton, mm, s</p>

VARIABLE	DESCRIPTION
	EQ.-6.0: lbf-s ² /in, in, s EQ.-7.0: slug, ft, s
CONL	CONM.GT.0.0: Length conversion factor from model units to calibration units for Miller's extension CONM.LT.0.0: Ignored
CONT	CONM.GT.0.0: Time conversion factor from model units to calibration units for Miller's extension CONM.LT.0.0: Ignored

Remarks:

1. **Equation of State.** The JWL equation of state defines the pressure as

$$p = A \left(1 - \frac{\omega}{R_1 V} \right) e^{-R_1 V} + B \left(1 - \frac{\omega}{R_2 V} \right) e^{-R_2 V} + \frac{\omega E}{V},$$

and is usually used for detonation products of high explosives.

A, B, and E0 have units of pressure. R1, R2, OMEG, and V0 are dimensionless. It is recommended that a unit system of gram, centimeter, microsecond be used when a model includes high explosive(s). In this consistent unit system, pressure is in Mbar.

2. **Afterburn.** The AFTERBURN option allows the addition of afterburn energy Q to the calculation of pressure by replacing E in the above equation with (E + Q), that is, the last term on the right-hand side becomes

$$\frac{\omega(E + Q)}{V}$$

The simple afterburn option adds the energy at a constant rate (OPT = 1) or a linearly-increasing rate (OPT = 2) between times T1 and T2 such that the total energy added per unit volume at time T2 is the specified energy QT.

For the Miller's extension model (OPT = 3), the afterburn energy is added using a time-dependent growth term

$$\frac{d\lambda}{dt} = a(1 - \lambda)^m p^n, \quad Q = \lambda Q_0 .$$

Here, m, n, and λ are dimensionless, with λ a positive fraction less than 1.0. The parameter a has units consistent with this growth equation, and Q₀ has units of pressure.

The values for Q_0 , a , m , n published by Miller and Guirguis (1993) are calibrated in the units of g , cm , μs , with the consistent pressure unit of Mbar, though in principle any consistent set of units may be used for calibration. The factors CONM, CONL, and CONT convert the unit system of the model being analyzed to the calibration unit system in which the Miller's extension parameters are specified, such that a mass value in model units may be multiplied by CONM to obtain the corresponding value in calibration units. These conversion factors allow consistent evaluation of the growth equation in the calibrated units. For user convenience, predefined conversion factors are provided for converting various choices for the model units system to the calibration unit system used by Miller and Guirguis.

3. **History Variables.** When this equation of state is used with *MAT_HIGH_EXPLOSIVE_BURN in which the variable BETA is set to 0 or 2, the absolute value of the history variable labeled as "effective plastic strain" is the explosive lighting time. This lighting time takes into account shadowing if invoked (see *CONTROL_EXPLOSIVE_SHADOW).

There are four additional history variables for the JWL equation of state. Those history variables are internal energy, bulk viscosity in units of pressure, volume, and burn fraction, respectively. To output the history variables, set the variable NEIPH in *DATABASE_EXTENT_BINARY.

The AFTERBURN option introduces an additional 5th history variable that records the added afterburn energy Q for simple afterburn (OPT = 1 or 2) but contains the growth term λ when using the Miller's extension model (OPT = 3).

***EOS_SACK_TUESDAY**

This is Equation of State Form 3.

Card 1	1	2	3	4	5	6	7	8
Variable	EOSID	A1	A2	A3	B1	B2	E0	V0
Type	A	F	F	F	F	F	F	F

VARIABLE**DESCRIPTION**

EOSID	Equation of state ID. A unique number or label must be specified (see *PART).
A_i, B_i	Constants in the equation of state
E0	Initial internal energy
V0	Initial relative volume

Remarks:

The Sack equation of state defines pressure as

$$p = \frac{A_3}{V^{A_1}} e^{-A_2 V} \left(1 - \frac{B_1}{V} \right) + \frac{B_2}{V} E$$

and is used for detonation products of high explosives.

*EOS_GRUNEISEN

This is Equation of State Form 4.

Card 1	1	2	3	4	5	6	7	8
Variable	EOSID	C	S1	S2	S3	GAMMA0	A	E0
Type	A	F	F	F	F	F	F	F

Card 2	1	2	3	4	5	6	7	8
Variable	V0	(not used)	LCID					
Type	F		I					

<u>VARIABLE</u>	<u>DESCRIPTION</u>
EOSID	Equation of state ID. A unique number or label must be specified (see *PART).
C, Si, GAMMA0	Constants in the equation of state
A	First order volume correction coefficient
E0	Initial internal energy
V0	Initial relative volume
LCID	Load curve ID, which can be the ID of a *DEFINE_CURVE, *DEFINE_CURVE_FUNCTION, or *DEFINE_FUNCTION, defining the energy deposition rate as a function of time. If an energy leak rate is intended, do not specify a negative ordinate in LCID, rather, use the constant(s) in the equation of state, that is, set GAMMA0 and/or A to a negative value. If *DEFINE_FUNCTION is used, the input of the defined function is time.

Remarks:

The Gruneisen equation of state with cubic shock-velocity as a function of particle-velocity $v_s(v_p)$ defines pressure for compressed materials as

$$p = \frac{\rho_0 C^2 \mu \left[1 + \left(1 - \frac{\gamma_0}{2} \right) \mu - \frac{a}{2} \mu^2 \right]}{\left[1 - (S_1 - 1) \mu - S_2 \frac{\mu^2}{\mu + 1} - S_3 \frac{\mu^3}{(\mu + 1)^2} \right]^2} + (\gamma_0 + a\mu) E$$

and for expanded materials as

$$p = \rho_0 C^2 \mu + (\gamma_0 + a\mu) E .$$

Here C is the intercept of the $v_s(v_p)$ curve (in velocity units); S_1 , S_2 , and S_3 are the unitless coefficients of the slope of the $v_s(v_p)$ curve; γ_0 is the unitless Gruneisen gamma; a is the unitless, first order volume correction to γ_0 ; and

$$\mu = \frac{\rho}{\rho_0} - 1 .$$

E denotes the internal energy, which is increased according to an energy deposition rate as a function of time curve (LCID).

*EOS_RATIO_OF_POLYNOMIALS

This is Equation of State Form 5.

Card Summary:

Card 1. This card is required.

EOSID							
-------	--	--	--	--	--	--	--

Card 2. This card is required.

A10	A11	A12	A13
-----	-----	-----	-----

Card 3. This card is required.

A20	A21	A22	A23
-----	-----	-----	-----

Card 4. This card is required.

A30	A31	A32	A33
-----	-----	-----	-----

Card 5. This card is required.

A40	A41	A42	A43
-----	-----	-----	-----

Card 6. This card is required.

A50	A51	A52	A53
-----	-----	-----	-----

Card 7. This card is required.

A60	A61	A62	A63
-----	-----	-----	-----

Card 8. This card is required.

A70	A71	A72	A73
-----	-----	-----	-----

Card 9. This card is required.

A14	A24		
-----	-----	--	--

Card 10. This card is required.

ALPHA	BETA	E0	V0
-------	------	----	----

Data Card Definitions:

Card 1	1	2	3	4	5	6	7	8
Variable	EOSID							
Type	A							

VARIABLE

DESCRIPTION

EOSID

Equation of state ID. A unique number or label must be specified (see *PART).

Card 2	1	2	3	4	5	6	7	8
Variable	A10		A11		A12		A13	
Type	F		F		F		F	

Card 3	1	2	3	4	5	6	7	8
Variable	A20		A21		A22		A23	
Type	F		F		F		F	

Card 4	1	2	3	4	5	6	7	8
Variable	A30		A31		A32		A33	
Type	F		F		F		F	

Card 5	1	2	3	4	5	6	7	8
Variable	A40		A41		A42		A43	
Type	F		F		F		F	

Card 6	1	2	3	4	5	6	7	8
Variable	A50		A51		A52		A53	
Type	F		F		F		F	

Card 7	1	2	3	4	5	6	7	8
Variable	A60		A61		A62		A63	
Type	F		F		F		F	

Card 8	1	2	3	4	5	6	7	8
Variable	A70		A71		A72		A73	
Type	F		F		F		F	

Card 9	1	2	3	4	5	6	7	8
Variable	A14		A24					
Type	F		F					

VARIABLE

DESCRIPTION

A_{ij}

Polynomial coefficients

Card 10	1	2	3	4	5	6	7	8
Variable	ALPHA		BETA		E0		V0	
Type	F		F		F		F	

VARIABLE	DESCRIPTION
ALPHA	α
BETA	β
E0	Initial internal energy
V0	Initial relative volume

Remarks:

The ratio of polynomials equation of state defines the pressure as

$$p = \frac{F_1 + F_2E + F_3E^2 + F_4E^3}{F_5 + F_6E + F_7E^2} (1 + \alpha\mu) ,$$

where

$$F_i = \sum_{j=0}^n A_{ij}\mu^j , \quad n = \begin{cases} 4 & i < 3 \\ 3 & i \geq 3 \end{cases}$$

$$\mu = \frac{\rho}{\rho_0} - 1$$

In expanded elements F_1 is replaced by $F'_1 = F_1 + \beta\mu^2$. By setting coefficient $A_{10} = 1.0$, the delta-phase pressure modeling for this material will be initiated. The code will reset it to 0.0 after setting flags.

***EOS_LINEAR_POLYNOMIAL_WITH_ENERGY_LEAK**

This is Equation of State Form 6.

Purpose: Define coefficients for a linear polynomial EOS and initialize the thermodynamic state of the material by defining E0 and V0 below. Energy deposition is prescribed using a curve.

Card 1	1	2	3	4	5	6	7	8
Variable	EOSID	C0	C1	C2	C3	C4	C5	C6
Type	A	F	F	F	F	F	F	F

Card 2	1	2	3	4	5	6	7	8
Variable	E0	V0	LCID					
Type	F	F	I					

VARIABLE

DESCRIPTION

EOSID	Equation of state ID. A unique number or label must be specified (see*PART).
<i>C_i</i>	Constants in the equation of state
E0	Initial internal energy
V0	Initial relative volume
LCID	Load curve ID, which can be the ID of *DEFINE_CURVE, *DEFINE_CURVE_FUNCTION or *DEFINE_FUNCTION, defining the energy deposition rate as a function of time. If an energy leak rate is intended, do not specify a negative ordinate in LCID, rather, use the constant(s) in the equation of state, such as setting C4 to a negative value. If *DEFINE_FUNCTION is used, the input of the defined function is time.

Remarks:

This polynomial equation of state, linear in the internal energy per initial volume, E , is given by

$$p = C_0 + C_1\mu + C_2\mu^2 + C_3\mu^3 + (C_4 + C_5\mu + C_6\mu^2)E$$

in which C_1, C_2, C_3, C_4, C_5 , and C_6 are user defined constants and

$$\mu = \frac{1}{V} - 1 .$$

where V is the relative volume. In expanded elements, we set the coefficients of μ^2 to zero, that is,

$$C_2 = C_6 = 0$$

Internal energy, E , is increased according to an energy deposition rate as a function of time curve (LCID).

*EOS_IGNITION_AND_GROWTH_OF_REACTION_IN_HE

This is Equation of State Form 7.

Card 1	1	2	3	4	5	6	7	8
Variable	EOSID	A	B	XP1	XP2	FRER	G	R1
Type	A	F	F	F	F	F	F	F

Card 2	1	2	3	4	5	6	7	8
Variable	R2	R3	R5	R6	FMXIG	FREQ	GROW1	EM
Type	F	F	F	F	F	F	F	F

Card 3	1	2	3	4	5	6	7	8
Variable	AR1	ES1	CVP	CVR	EETAL	CCRIT	ENQ	TMP0
Type	F	F	F	F	F	F	F	F

Card 4	1	2	3	4	5	6	7	8
Variable	GROW2	AR2	ES2	EN	FMXGR	FMNGR		
Type	F	F	F	F	F	F		

VARIABLE

DESCRIPTION

- EOSID Equation of state ID. A unique number or label must be specified (see *PART).
- A Product JWL constant (see second equation in Remarks)
- B Product JWL constant (see second equation in Remarks)
- XP1 Product JWL constant (see second equation in Remarks)

VARIABLE	DESCRIPTION
XP2	Product JWL constant (see second equation in Remarks)
FRER	Constant in ignition term of reaction equation
G	ωC_v of product
R1	Unreacted JWL constant (see first equation in Remarks)
R2	Unreacted JWL constant (see first equation in Remarks)
R3	ωC_v of unreacted explosive
R5	Unreacted JWL constant (see first equation in Remarks)
R6	Unreacted JWL constant (see first equation in Remarks)
FMXIG	Maximum F for ignition term
FREQ	Constant in ignition term of reaction equation
GROW1	Constant in growth term of reaction equation
EM	Constant in growth term of reaction equation
AR1	Constant in growth term of reaction equation
ES1	Constant in growth term of reaction equation
CVP	Heat capacity of reaction products
CVR	Heat capacity of unreacted HE
EETAL	Constant in ignition term of reaction equation
CCRIT	Constant in ignition term of reaction equation
ENQ	Heat of reaction
TMP0	Initial temperature ($^{\circ}$ K)
GROW2	Constant in completion term of reaction equation
AR2	Constant in completion term of reaction equation
ES2	Constant in completion term of reaction equation
EN	Constant in completion term of reaction equation

VARIABLE	DESCRIPTION
FMXGR	Maximum F for growth term
FMNGR	Maximum F for completion term

Remarks:

Equation of State Form 7 is used to calculate the shock initiation (or failure to initiate) and detonation wave propagation of solid high explosives. It should be used instead of the ideal HE burn options whenever there is a question whether the HE will react, there is a finite time required for a shock wave to build up to detonation, and/or there is a finite thickness of the chemical reaction zone in a detonation wave. At relatively low initial pressures (<2-3 GPa), this equation of state should be used with material type 10 for accurate calculations of the unreacted HE behavior. At higher initial pressures, material type 9 can be used. A JWL equation of state defines the pressure in the unreacted explosive as

$$P_e = r_1 e^{-r_5 V_e} + r_2 e^{-r_6 V_e} + r_3 \frac{T_e}{V_e}, \quad (r_3 = \omega_e C_{v_r})$$

where V_e and T_e are the relative volume and temperature, respectively, of the unreacted explosive. Another JWL equation of state defines the pressure in the reaction products as

$$P_p = a e^{-x p_1 V_p} + b e^{-x p_2 V_p} + \frac{g T_p}{V_p}, \quad (g = \omega_p C_{v_p})$$

where V_p and T_p are the relative volume and temperature, respectively, of the reaction products. As the chemical reaction converts unreacted explosive to reaction products, these JWL equations of state are used to calculate the mixture of unreacted explosive and reaction products defined by the fraction reacted F ($F = 0$ implies no reaction, $F = 1$ implies complete reaction). The temperatures and pressures are assumed to be equal ($T_e = T_p, p_e = p_p$) and the relative volumes are additive, that is,

$$V = (1 - F)V_e + FV_p$$

The chemical reaction rate for conversion of unreacted explosive to reaction products consists of three physically realistic terms: an ignition term in which a small amount of explosive reacts soon after the shock wave compresses it; a slow growth of reaction as this initial reaction spreads; and a rapid completion of reaction at high pressure and temperature. The form of the reaction rate equation is

$$\frac{\partial F}{\partial t} = \overbrace{\text{FREQ} \times (1 - F)^{\text{FRER}} (V_e^{-1} - 1 - \text{CCRIT})^{\text{EETAL}}}_{\text{Ignition}} + \overbrace{\text{GROW1} \times (1 - F)^{\text{ES1}} F^{\text{AR1}} p^{\text{EM}}}_{\text{Growth}} + \overbrace{\text{GROW2} \times (1 - F)^{\text{ES2}} F^{\text{AR2}} p^{\text{EN}}}_{\text{Completion}}$$

The ignition rate is set equal to zero when $F \geq \text{FMXIG}$, the growth rate is set equal to zero when $F \geq \text{FMXGR}$, and the completion rate is set equal to zero when $F \leq \text{FMNGR}$.

Details of the computational methods and many examples of one and two dimensional shock initiation and detonation wave calculation can be found in the references (Cochran and Chan [1979], Lee and Tarver [1980]). Unfortunately, sufficient experimental data has been obtained for only two solid explosives to develop very reliable shock initiation models: PBX-9504 (and the related HMX-based explosives LX-14,LX-10,LX-04, etc.) and LX-17 (the insensitive TATB-based explosive). Reactive flow models have been developed for other explosives (TNT, PETN, Composition B, propellants, etc.) but are based on very limited experimental data.

When this EOS is used with *MAT_009, history variables 4, 7, 9, and 10 are temperature, burn fraction, $1/V_e$, and $1/V_p$, respectively. When used with *MAT_010, those history variables are incremented by 1, that is, history variables 5, 8, 10, and 11 are temperature, burn fraction, $1/V_e$, and $1/V_p$, respectively. See NEIPH in *DATABASE_EXTENT_BINARY if these output variables are desired in the databases for post-processing.

*EOS_TABULATED_COMPACION

This is Equation of State Form 8.

Card 1	1	2	3	4	5	6	7	8
Variable	EOSID	GAMMA	E0	V0	LCC	LCT	LCK	LCID
Type	A	F	F	F	I	I	I	I

Parameter Card Pairs. Include one pair of the following two cards for each of $VAR = \varepsilon_{v_i}$, C_i , T_i , and K_i . These cards consist of four additional pairs for a total of 8 additional cards.

Card 3	1	2	3	4	5	6	7	8	9	10
Variable	[VAR]1		[VAR]2		[VAR]3		[VAR]4		[VAR]5	
Type	F		F		F		F		F	

Card 4	1	2	3	4	5	6	7	8	9	10
Variable	[VAR]6		[VAR]7		[VAR]8		[VAR]9		[VAR]10	
Type	F		F		F		F		F	

VARIABLE**DESCRIPTION**

EOSID	Equation of state ID. A unique number or label must be specified (see *PART).
GAMMA	γ (unitless); see equation in Remarks.
E0	Initial internal energy per unit reference volume (force per unit area)
V0	Initial relative volume (unitless)

VARIABLE	DESCRIPTION
LCC	Load curve defining tabulated function C . See equation in Remarks. The abscissa values of LCC, LCT and LCK must be negative of the volumetric strain in monotonically <i>increasing</i> order, in contrast to the convention in *EOS_009. The definition can extend into the tensile regime.
LCT	Load curve defining tabulated function T . See equation in Remarks.
LCK	Load curve defining tabulated bulk modulus
LCID	Load curve ID, which can be the ID of *DEFINE_CURVE, *DEFINE_CURVE_FUNCTION or *DEFINE_FUNCTION, defining the energy deposition rate as a function of time. If an energy leak rate is intended, do not specify a negative ordinate in LCID, rather, use the constant(s) in the equation of state, that is, set GAMMA to a negative value. If *DEFINE_FUNCTION is used, the input of the defined function is time.
$\varepsilon_{v1}, \varepsilon_{v2}, \dots, \varepsilon_{vN}$	Volumetric strain, $\ln(V)$. The first abscissa point, EV1, must be 0.0 or positive if the curve extends into the tensile regime with subsequent points <i>decreasing</i> monotonically.
C_1, C_2, \dots, C_N	$C(\varepsilon_V)$ (units = force per unit area); see equation in Remarks.
T_1, T_2, \dots, T_N	$T(\varepsilon_V)$ (unitless) ; see equation in Remarks.
K_1, K_2, \dots, K_N	Bulk unloading modulus (units = force per unit area)

Remarks:

The tabulated compaction model is linear in the internal energy E , which is increased according to an energy deposition rate as a function of time curve (LCID). Pressure is defined by

$$p = C(\varepsilon_V) + \gamma T(\varepsilon_V)E$$

in the loading phase. The volumetric strain, ε_V , is given by the natural logarithm of the relative volume, V . Unloading occurs along the unloading bulk modulus to the pressure cutoff. The pressure cutoff, a tension limit, is defined in the material model definition. Reloading always follows the unloading path to the point where unloading began and continues on the loading path; see [Figure EOS8-1](#). Up to 10 points and as few as 2 may be used when defining the tabulated functions. LS-DYNA will extrapolate to find the pressure if necessary.

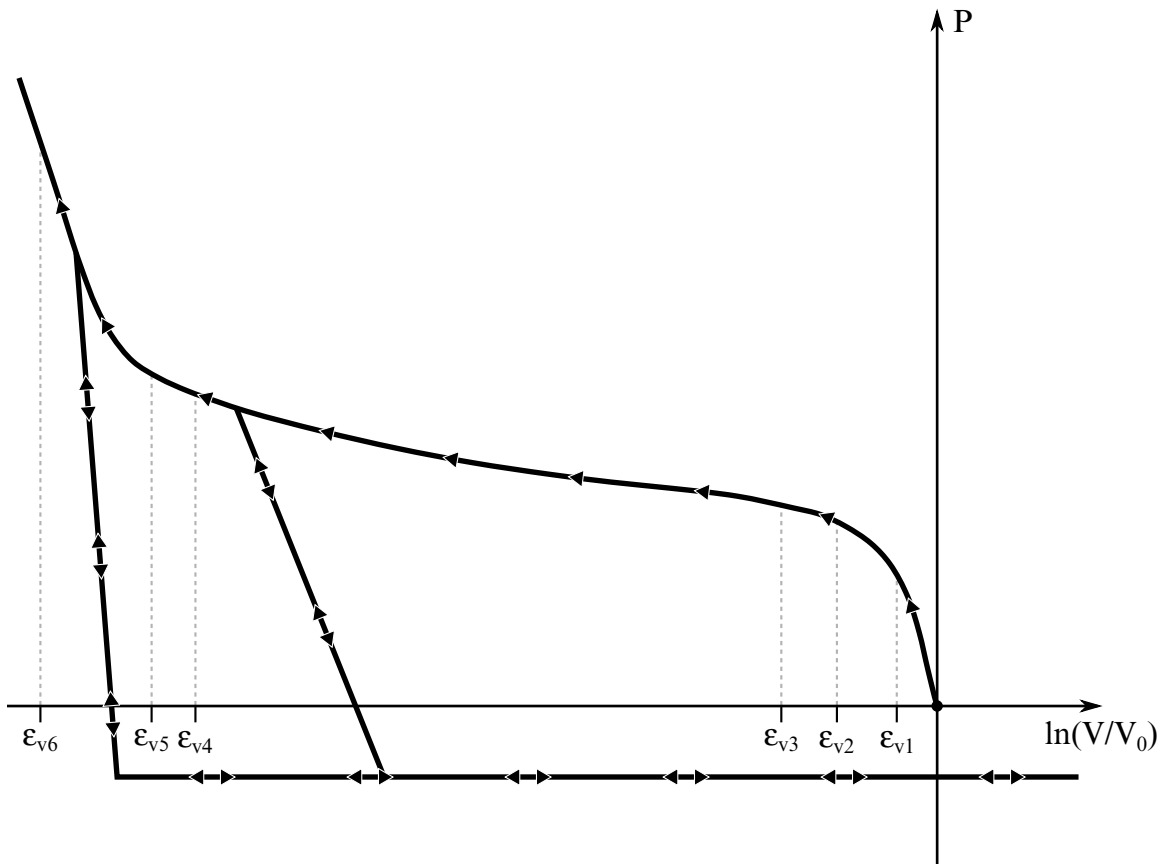

Figure EOS8-1. Pressure as a function of volumetric strain curve for Equation of State Form 8 with compaction. In the compacted states the bulk unloading modulus depends on the peak volumetric strain. Volumetric strain values should be input with correct sign (negative in compression) and in descending order. Pressure is positive in compression.

***EOS_TABULATED**

This is Equation of State Form 9.

Card 1	1	2	3	4	5	6	7	8
Variable	EOSID	GAMA	E0	V0	LCC	LCT		
Type	A	F	F	F	I	I		

Parameter Card Pairs. Include one pair of the following two cards for each of $VAR = \varepsilon_{V_i}, C_i, T_i$. These cards consist of three additional pairs for a total of 6 additional cards. These cards are not required if LCC and LCT are specified.

Card 2	1	2	3	4	5	6	7	8	9	10
Variable	[VAR]1		[VAR]2		[VAR]3		[VAR]4		[VAR]5	
Type	F		F		F		F		F	

Card 3	1	2	3	4	5	6	7	8	9	10
Variable	[VAR]6		[VAR]7		[VAR]8		[VAR]9		[VAR]10	
Type	F		F		F		F		F	

VARIABLE**DESCRIPTION**

EOSID	Equation of state ID. A unique number or label must be specified (see *PART).
GAMA	γ , (unitless) see equation in Remarks.
E0	Initial internal energy per unit reference volume (force per unit area).
V0	Initial relative volume (unitless).

VARIABLE	DESCRIPTION
LCC	Load curve defining tabulated function C . See equation in Remarks. The abscissa values of LCC and LCT must <i>increase</i> monotonically. The definition can extend into the tensile regime.
LCT	Load curve defining tabulated function T . See equation in Remarks.
$\varepsilon_{V_1}, \varepsilon_{V_2}, \dots, \varepsilon_{V_N}$	Volumetric strain, $\ln(V)$, where V is the relative volume. The first abscissa point, EV1, must be 0.0 or positive if the curve extends into the tensile regime with subsequent points <i>decreasing</i> monotonically.
C_1, C_2, \dots, C_N	Tabulated points for function C (force per unit area).
T_1, T_2, \dots, T_N	Tabulated points for function T (unitless).

Remarks:

The tabulated equation of state model is linear in internal energy. Pressure is defined by

$$P = C(\varepsilon_V) + \gamma T(\varepsilon_V)E$$

The volumetric strain, ε_V is given by the natural logarithm of the relative volume V . Up to 10 points and as few as 2 may be used when defining the tabulated functions. LS-DYNA will extrapolate to find the pressure if necessary.

EOS**EOS_PROPELLANT_DEFLAGRATION*****EOS_PROPELLANT_DEFLAGRATION**

This is Equation of State Form 10. It has been added to model airbag propellants.

Card 1	1	2	3	4	5	6	7	8
Variable	EOSID	A	B	XP1	XP2	FRER		
Type	A	F	F	F	F	F		

Card 2	1	2	3	4	5	6	7	8
Variable	G	R1	R2	R3	R5			
Type	F	F	F	F	F			

Card 3	1	2	3	4	5	6	7	8
Variable	R6	FMXIG	FREQ	GROW1	EM			
Type	F	F	F	F	F			

Card 4	1	2	3	4	5	6	7	8
Variable	AR1	ES1	CVP	CVR	EETAL	CCRIT	ENQ	TMP0
Type	F	F	F	F	F			

Card 5	1	2	3	4	5	6	7	8
Variable	GROW2	AR2	ES2	EN	FMXGR	FMNGR		
Type	F	F	F	F	F	F		

VARIABLE	DESCRIPTION
EOSID	Equation of state ID. A unique number or label must be specified (see *PART).
A	Product JWL coefficient
B	Product JWL coefficient
XP1	Product JWL coefficient
XP2	Product JWL coefficient
FRER	Unreacted Co-volume
G	Product ωC_v
R1	Unreacted JWL coefficient
R2	Unreacted JWL coefficient
R3	Unreacted ωC_v
R5	Unreacted JWL coefficient
R6	Unreacted JWL coefficient
FMXIG	Initial Fraction Reacted F_0
FREQ	Initial Pressure P_0
GROW1	First burn rate coefficient
EM	Pressure Exponent (1 st term)
AR1	Exponent on F (1 st term)
ES1	Exponent on $(1 - F)$ (1 st term)
CVP	Heat capacity C_v for products
CVR	Heat capacity C_v for unreacted material
EETAL	Extra, not presently used
CCRIT	Product co-volume
ENQ	Heat of Reaction

VARIABLE	DESCRIPTION
TMP0	Initial Temperature (298°K)
GROW2	Second burn rate coefficient
AR2	Exponent on F (2 nd term)
ES2	Exponent on $(1 - F)$ (2 nd term)
EN	Pressure Exponent (2 nd term)
FMXGR	Maximum F for 1 st term
FMNGR	Minimum F for 2 nd term

Remarks:

A deflagration (burn rate) reactive flow model requires an unreacted solid equation of state, a reaction product equation of state, a reaction rate law and a mixture rule for the two (or more) species. The mixture rule for the standard ignition and growth model [Lee and Tarver 1980] assumes that both pressures and temperatures are completely equilibrated as the reaction proceeds. However, the mixture rule can be modified to allow no thermal conduction or partial heating of the solid by the reaction product gases. For this relatively slow process of airbag propellant burn, the thermal and pressure equilibrium assumptions are valid. The equations of state currently used in the burn model are the JWL, Gruneisen, the van der Waals co-volume, and the perfect gas law, but other equations of state can be easily implemented. In this propellant burn, the gaseous nitrogen produced by the burning sodium azide obeys the perfect gas law as it fills the airbag but may have to be modeled as a van der Waal's gas at the high pressures and temperatures produced in the propellant chamber. The chemical reaction rate law is pressure, particle geometry and surface area dependent, as are most high-pressure burn processes. When the temperature profile of the reacting system is well known, temperature dependent Arrhenius chemical kinetics can be used.

Since the airbag propellant composition and performance data are company private information, it is very difficult to obtain the required information for burn rate modeling. However, Imperial Chemical Industries (ICI) Corporation supplied pressure exponent, particle geometry, packing density, heat of reaction, and atmospheric pressure burn rate data which allowed us to develop the numerical model presented here for their $\text{NaN}_3 + \text{Fe}_2\text{O}_3$ driver airbag propellant. The deflagration model, its implementation, and the results for the ICI propellant are presented in [Hallquist, et.al., 1990].

The unreacted propellant and the reaction product equations of state are both of the form:

$$p = Ae^{-R_1V} + Be^{-R_2V} + \frac{\omega C_v T}{V - d},$$

where p is pressure (in Mbars), V is the relative specific volume (inverse of relative density), ω is the Gruneisen coefficient, C_v is heat capacity (in Mbars-cc/cc°K), T is the temperature in °K, d is the co-volume, and A , B , R_1 and R_2 are constants. Setting $A = B = 0$ yields the van der Waal's co-volume equation of state. The JWL equation of state is generally useful at pressures above several kilobars, while the van der Waal's is useful at pressures below that range and above the range for which the perfect gas law holds. Additionally, setting $A = B = d = 0$ yields the perfect gas law. If accurate values of ω and C_v plus the correct distribution between "cold" compression and internal energies are used, the calculated temperatures are very reasonable and thus can be used to check propellant performance.

The reaction rate used for the propellant deflagration process is of the form:

$$\frac{\partial F}{\partial t} = \underbrace{Z(1-F)^y F^x p^w}_{0 < F < F_{\text{limit1}}} + \underbrace{V(1-F)^u F^r p^s}_{F_{\text{limit2}} < F < 1}$$

where F is the fraction reacted ($F = 0$ implies no reaction, $F = 1$ is complete reaction), t is time, and p is pressure (in Mbars), r , s , u , w , x , y , F_{limit1} and F_{limit2} are constants used to describe the pressure dependence and surface area dependence of the reaction rates. Two (or more) pressure dependant reaction rates are included in case the propellant is a mixture or exhibited a sharp change in reaction rate at some pressure or temperature. Burning surface area dependencies can be approximated using the $(1-F)^y F^x$ terms. Other forms of the reaction rate law, such as Arrhenius temperature dependent $e^{-E/RT}$ type rates, can be used, but these require very accurate temperatures calculations. Although the theoretical justification of pressure dependent burn rates at kilobar type pressures is not complete, a vast amount of experimental burn rate as a function of pressure data does demonstrate this effect and hydrodynamic calculations using pressure dependent burn accurately simulate such experiments.

The deflagration reactive flow model is activated by any pressure or particle velocity increase on one or more zone boundaries in the reactive material. Such an increase creates pressure in those zones and the decomposition begins. If the pressure is relieved, the reaction rate decreases and can go to zero. This feature is important for short duration, partial decomposition reactions. If the pressure is maintained, the fraction reacted eventually reaches one and the material is completely converted to product molecules. The deflagration front rates of advance through the propellant calculated by this model for several propellants are quite close to the experimentally observed burn rate versus pressure curves.

To obtain good agreement with experimental deflagration data, the model requires an accurate description of the unreacted propellant equation of state, either an analytical fit to experimental compression data or an estimated fit based on previous experience with

similar materials. This is also true for the reaction products equation of state. The more experimental burn rate, pressure production and energy delivery data available, the better the form and constants in the reaction rate equation can be determined.

Therefore, the equation used in the burn subroutine for the pressure in the unreacted propellant is

$$P_u = R1 \times e^{-R5 \times V_u} + R2 \times e^{-R6 \times V_u} + \frac{R3 \times T_u}{V_u - FRER} ,$$

where V_u and T_u are the relative volume and temperature respectively of the unreacted propellant. The relative density is obviously the inverse of the relative volume. The pressure P_p in the reaction products is given by:

$$P_p = A \times e^{-XP1 \times V_p} + B \times e^{-XP2 \times V_p} + \frac{G \times T_p}{V_p - CCRIT} .$$

As the reaction proceeds, the unreacted and product pressures and temperatures are assumed to be equilibrated ($T_u = T_p = T$, $P = P_u = P_p$) while the relative volumes are additive:

$$V = (1 - F)V_u + FV_p$$

where V is the total relative volume. Other mixture assumptions can and have been used in different versions of DYNA2D/3D. The reaction rate law has the form:

$$\frac{\partial F}{\partial t} = \text{GROW1} \times (P + \text{FREQ})^{\text{EM}} (F + \text{FMXIG})^{\text{AR1}} (1 - F + \text{FMIXG})^{\text{ES1}} \\ + \text{GROW2} \times (P + \text{FREQ})^{\text{EN}} (F + \text{FMIXG})^{\text{AR2}} (1 - F + \text{FMIXG})^{\text{ES2}} .$$

If F exceeds FMXGR , the GROW1 term is set equal to zero, and, if F is less than FMNGR , the GROW2 term is zero. Thus, two separate (or overlapping) burn rates can be used to describe the rate at which the propellant decomposes.

This equation of state subroutine is used together with a material model to describe the propellant. In the airbag propellant case, a null material model (type #10) can be used. Material type 10 is usually used for a solid propellant or explosive when the shear modulus and yield strength are defined. The propellant material is defined by the material model and the unreacted equation of state until the reaction begins. The calculated mixture states are used until the reaction is complete and then the reaction product equation of state is used. The heat of reaction, ENQ , is assumed to be a constant and the same at all values of F but more complex energy release laws could be implemented.

History variables 4 and 7 are temperature and burn fraction, respectively. See NEIPH in $\text{*DATABASE_EXTENT_BINARY}$ if these output variables are desired in the databases for post-processing.

*EOS_TENSOR_PORE_COLLAPSE

This is Equation of State Form 11.

Card 1	1	2	3	4	5	6	7	8
Variable	EOSID	NLD	NCR	MU1	MU2	IE0	EC0	
Type	A8	F	F	F	F	F	F	

VARIABLE

DESCRIPTION

EOSID	Equation of state ID. A unique number or label must be specified (see *PART).
NLD	Virgin loading load curve ID
NCR	Completely crushed load curve ID
MU1	Excess Compression required before any pores can collapse
MU2	Excess Compression point where the Virgin Loading Curve and the Completely Crushed Curve intersect
IE0	Initial Internal Energy
EC0	Initial Excess Compression

Remarks:

The pore collapse model described in the TENSOR manual [23] is no longer valid and has been replaced by a much simpler method. This is due in part to the lack of experimental data required for the more complex model. It is desired to have a close approximation of the TENSOR model in the LS-DYNA code to enable a quality link between them. The TENSOR model defines two curves, the virgin loading curve and the completely crushed curve, as shown in [Figure EOS11-1](#), as well as the excess compression point required for pore collapse to begin, μ_1 , and the excess compression point required to completely crush the material, μ_2 . From this data and the maximum excess compression the material has attained, u_{max} , the pressure for any excess compression, μ , can be determined.

Unloading occurs along the virgin loading curve until the excess compression surpasses μ_1 . After that, the unloading follows a path between the completely crushed curve and the virgin loading curve. Reloading will follow this curve back up to the virgin loading

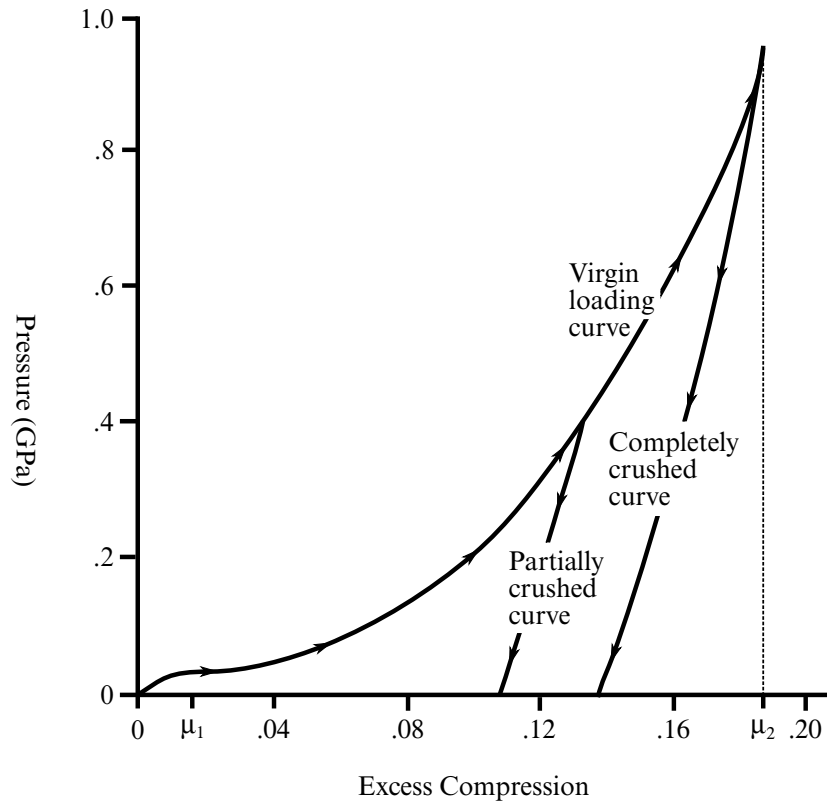

Figure EOS11-1. Pressure versus compaction curve

curve. Once the excess compression exceeds μ_2 , then all unloading will follow the completely crushed curve.

For unloading between μ_1 and μ_2 a partially crushed curve is determined by:

$$p_{pc}(\mu) = p_{cc} \left[\frac{\overbrace{(1 + \mu_B)(1 + \mu)}^{\mu_a}}{1 + \mu_{max}} - 1 \right],$$

where

$$\mu_B = P_{cc}^{-1}(P_{max})$$

and the subscripts “pc” and “cc” refer to the partially crushed and completely crushed states, respectively. This is more readily understood in terms of the relative volume, V .

$$V = \frac{1}{1 + \mu}$$

$$P_{pc}(V) = P_{cc} \left(\frac{V_B}{V_{min}} V \right)$$

This representation suggests that for a fixed

$$V_{min} = \frac{1}{\mu_{max} + 1}$$

the partially crushed curve will separate linearly from the completely crushed curve as V increases to account for pore recovery in the material.

The bulk modulus K is determined to be the slope of the current curve times one plus the excess compression

$$K = \frac{\partial P}{\partial \mu} (1 + \mu) .$$

The slope $\frac{\partial P}{\partial \mu}$ for the partially crushed curve is obtained by differentiation as:

$$\frac{\partial p_{pc}}{\partial \mu} = \frac{\partial p_{cc}}{\partial x} \Big|_{x=\frac{(1+\mu_b)(1+\mu)}{1+\mu_{max}}-1} \left(\frac{1 + \mu_b}{1 + \mu_{max}} \right) .$$

Simplifying,

$$K = \frac{\partial P_{cc}}{\partial \mu_a} \Big|_{\mu_a} (1 + \mu_a) ,$$

where

$$\mu_a = \frac{(1 + \mu_b)(1 + \mu)}{(1 + \mu_{max})} - 1 .$$

The bulk sound speed is determined from the slope of the completely crushed curve at the current pressure to avoid instabilities in the time step.

The virgin loading and completely crushed curves are modeled with monotonic cubic-splines. An optimized vector interpolation scheme is then used to evaluate the cubic-splines. The bulk modulus and sound speed are derived from a linear interpolation on the derivatives of the cubic-splines.

***EOS_IDEAL_GAS**

Purpose: This is Equation of State Form 12 for modeling ideal gas. It is an alternate approach to using *EOS_LINEAR_POLYNOMIAL with $C4 = C5 = (\gamma - 1)$ to model ideal gas. This has a slightly improved energy accounting algorithm.

Card 1	1	2	3	4	5	6	7	8
Variable	EOSID	CV0	CP0	CL	CQ	T0	V0	VCO
Type	A	F	F	F	F	F	F	F

Card 2	1	2	3	4	5	6	7	8
Variable	ADIAB							
Type	F							

VARIABLE**DESCRIPTION**

EOSID	Equation of state ID. A unique number or label must be specified (see *PART).
CV0	Nominal constant-volume specific heat coefficient (at STP)
CP0	Nominal constant-pressure specific heat coefficient (at STP)
CL	Linear coefficient for the variations of C_v and C_p as a function of T .
CQ	Quadratic coefficient for the variations of C_v and C_p as a function of T .
T0	Initial temperature
V0	Initial relative volume (see the beginning of the *EOS section)
VCO	Van der Waals covolume
ADIAB	Adiabatic flag: EQ.0.0: Off EQ.1.0: On; ideal gas follows adiabatic law

Remarks:

1. **Pressure.** The pressure in the ideal gas law is defined as

$$p = \rho(C_p - C_v)T$$

$$C_p = C_{p0} + C_L T + C_Q T^2$$

$$C_v = C_{v0} + C_L T + C_Q T^2$$

where C_p and C_v are the specific heat capacities at constant pressure and at constant volume, respectively. ρ is the density. The relative volume is defined as

$$v_r = \frac{V}{V_0} = \frac{(V/M)}{(V_0/M)} = \frac{v}{v_0} = \frac{\rho_0}{\rho},$$

where ρ_0 is a nominal or reference density defined in the *MAT_NULL card. The initial pressure can then be manually computed as

$$P|_{t=0} = \rho|_{t=0}(C_P - C_V)T|_{t=0}$$

$$\rho|_{t=0} = \left\{ \frac{\rho_0}{v_r|_{t=0}} \right\}$$

$$P|_{t=0} = \left\{ \frac{\rho_0}{v_r|_{t=0}} \right\} (C_P - C_V)T|_{t=0}$$

The initial relative volume, $v_r|_{t=0}$ (V0), initial temperature, $T|_{t=0}$ (T0), and heat capacity information are defined in the *EOS_IDEAL_GAS input. Note that the “reference” density is typically a density at a non-stressed or nominal stress state. The initial pressure should always be checked manually against simulation result.

2. **Energy Conservation.** With adiabatic flag on, the adiabatic state is conserved, but *exact* internal energy conservation is sacrificed.
3. **Deviation from Ideal Gas Model.** The ideal gas model is good for low density gas only. Deviation from the ideal gas behavior may be indicated by the compressibility factor defined as

$$Z = \frac{Pv}{RT}$$

When Z deviates from 1, the gas behavior deviates from ideal.

4. **Initial Temperature and Initial Relative Volume.** V0 and T0 defined in this card must be the same as the time-zero ordinates for the 2 load curves defined in the *BOUNDARY_AMBIENT_EOS card, if it is used. This is so that they both would consistently define the same initial state for a material.

***EOS_PHASE_CHANGE**

This is Equation of State Form 13. This EOS was designed for phase change from liquid to vapor, based on the homogeneous Schmidt model.

Card 1	1	2	3	4	5	6	7	8
Variable	EOSID	RHOL	RHOV	CL	CV	GAMAL	PV	KL
Type	A8	F	F	F	F	F	F	F

Card 2	1	2	3	4	5	6	7	8
Variable	E0	V0						
Type	F	F						

VARIABLE**DESCRIPTION**

EOSID	Equation of state ID. A unique number or label must be specified (see *PART).
RHOL	Density of liquid
RHOV	Density of saturated vapor
CL	Speed of sound of liquid
CV	Speed of sound of vapor
GAMAL	Gamma constant of liquid
PV	Pressure of vapor
KL	Bulk compressibility of liquid
E0	Initial internal energy
V0	Initial relative volume or initial pressure. GT.0.0: Initial relative volume. Default = 1 LT.0.0: Initial pressure.

Remarks:

This model is barotropic, so the pressure is only a function of density change. Details of the model can be found in Souli et al. [2014]. Examples of applications for this model are simulations involving water hammer or fuel injection. The ambient pressure should normally be set to atmospheric pressure.

Example input for water in the MKS system (m, kg, s):

```
*EOS_PHASE_CHANGE
$ EOSID      RHOL      RHOV      CL      CV      PV
  1 9.9742e+2  2.095e-2  1492.00  425.00  1.e+5
```

***EOS_JWLB**

This is Equation of State Form 14. The JWLB (Jones-Wilkens-Lee-Baker) equation of state, developed by Baker [1991] and further described by Baker and Orosz [1991], describes the high pressure regime produced by overdriven detonations while retaining the low pressure expansion behavior required for standard acceleration modeling. The derived form of the equation of state is based on the JWL form due to its computational robustness and asymptotic approach to an ideal gas at high expansions. Additional exponential terms and a variable Gruneisen parameter have been added to adequately describe the high-pressure region above the Chapman-Jouguet state.

Card 1	1	2	3	4	5	6	7	8
Variable	EOSID	A1	A2	A3	A4	A5		
Type	A	F	F	F	F	F		

Card 2	1	2	3	4	5	6	7	8
Variable	R1	R2	R3	R4	R5			
Type	F	F	F	F	F			

Card 3	1	2	3	4	5	6	7	8
Variable	AL1	AL2	AL3	AL4	AL5			
Type	F	F	F	F	F			

Card 4	1	2	3	4	5	6	7	8
Variable	BL1	BL2	BL3	BL4	BL5			
Type	F	F	F	F	F			

Card 5	1	2	3	4	5	6	7	8
Variable	RL1	RL2	RL3	RL4	RL5			
Type	F	F	F	F	F			

Card 6	1	2	3	4	5	6	7	8
Variable	C	OMEGA	E	V0				
Type	F	F	F	F				

VARIABLE**DESCRIPTION**

EOSID	Equation of state identification. A unique number or label must be specified (see *PART).
A_i	Equation of state coefficient A_i . See below.
R_i	Equation of state coefficient R_i . See below.
AL_i	Equation of state coefficient $A_{\lambda i}$. See below.
BL_i	Equation of state coefficient $B_{\lambda i}$. See below.
RL_i	Equation of state coefficient $R_{\lambda i}$. See below.
C	Equation of state coefficient C. See below.
OMEGA	Equation of state coefficient ω . See below.
E	Energy density per unit volume
V0	Initial relative volume

Remarks:

The JWLB equation-of-state defines the pressure as

$$p = \sum_{i=1}^5 A_i \left(1 - \frac{\lambda}{R_i V}\right) e^{-R_i V} + \frac{\lambda E}{V} + C \left(1 - \frac{\lambda}{\omega}\right) V^{-(\omega+1)}$$

$$\lambda = \sum_{i=1}^5 (A_{\lambda i} V + B_{\lambda i}) e^{-R_{\lambda i} V} + \omega$$

where V is the relative volume, E is the energy per unit initial volume, and A_i , R_i , $A_{\lambda i}$, $B_{\lambda i}$, $R_{\lambda i}$, C , and ω are input constants defined above.

JWLB input constants for some common explosives as found in Baker and Stiel [1997] are given in the following table.

	TATB	LX-14	PETN	TNT	Octol 70/30
ρ_0 (g/cc)	1.800	1.821	1.765	1.631	1.803
E_0 (Mbar)	.07040	.10205	.10910	.06656	.09590
D_{CJ} (cm/ μ s)	.76794	.86619	.83041	.67174	.82994
P_{CJ} (Mbar)	.23740	.31717	.29076	.18503	.29369
A_1 (Mbar)	550.06	549.60	521.96	490.07	526.83
A_2 (Mbar)	22.051	64.066	71.104	56.868	60.579
A_3 (Mbar)	.42788	2.0972	4.4774	.82426	.91248
A_4 (Mbar)	.28094	.88940	.97725	.00093	.00159
R_1	16.688	34.636	44.169	40.713	52.106
R_2	6.8050	8.2176	8.7877	9.6754	8.3998
R_3	2.0737	20.401	25.072	2.4350	2.1339
R_4	2.9754	2.0616	2.2251	.15564	.18592
C (Mbar)	.00776	.01251	.01570	.00710	.00968
ω	.27952	.38375	.32357	.30270	.39023
$A_{\lambda 1}$	1423.9	18307.	12.257	.00000	.011929
$B_{\lambda 1}$	14387.	1390.1	52.404	1098.0	18466.
$R_{\lambda 1}$	19.780	19.309	43.932	15.614	20.029
$A_{\lambda 2}$	5.0364	4.4882	8.6351	11.468	5.4192
$B_{\lambda 2}$	-2.6332	-2.6181	-4.9176	-6.5011	-3.2394
$R_{\lambda 2}$	1.7062	1.5076	2.1303	2.1593	1.5868

***EOS_GASKET**

This is Equation of State Form 15. This EOS works with solid elements and thick shell formulations ELFORM = 2, 3, 5 and 7 to model the response of gaskets. For the thick shell formulation #2 only, it is completely decoupled from the shell material, meaning in the local coordinate system of the shell, this model defines the normal stress, σ_{zz} , and does not change any of the other stress components. The model is a reduction of the *MAT_GENERAL_NONLINEAR_6DOF_DISCRETE_BEAM.

Card 1	1	2	3	4	5	6	7	8
Variable	EOSID	LCID1	LCID2	LCID3	LCID4			
Type	A	I	I	I	I			

Card 2	1	2	3	4	5	6	7	8
Variable	UNLOAD	K	DMPF	TFS	CFS	LOFFSET	IVS	
Type	F	F	F	F	F	F	F	

VARIABLE**DESCRIPTION**

EOSID	Equation of state ID. A unique number or label must be specified (see *PART).
LCID1	Load curve for loading
LCID2	Load curve for unloading
LCID3	Load curve for damping as a function of volumetric strain rate
LCID4	Load curve for scaling the damping as a function of the volumetric strain
UNLOAD	Unloading option (see Figure EOS15-1): EQ.0.0: Loading and unloading follow loading curve EQ.1.0: Loading follows loading curve, unloading follows unloading curve. The unloading curve ID if undefined is taken as the loading curve.

VARIABLE

DESCRIPTION

EQ.2.0: Loading follows loading curve, unloading follows unloading stiffness, K , to the unloading curve. The loading and unloading curves may only intersect at the origin of the axes.

EQ.3.0: Quadratic unloading from peak displacement value to a permanent offset.

Unload = 0 PRESSURE Unloading stiffness, for UNLOAD = 2 only

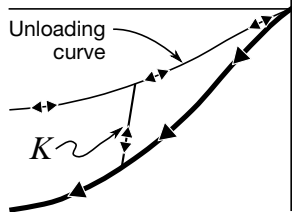
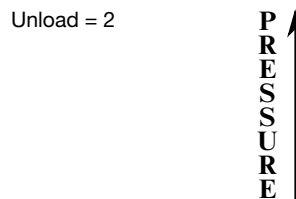
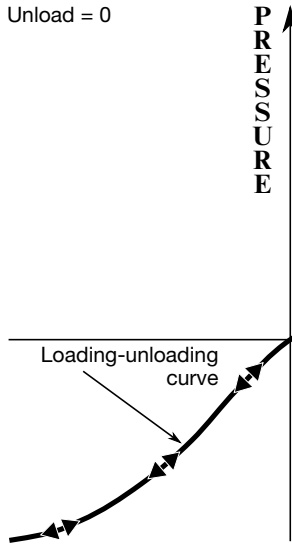

K

DMPF

Damping factor for stability. Values in the neighborhood of unity are recommended. The damping factor is properly scaled to eliminate time step size dependency.

VARIABLE	DESCRIPTION
TFS	Tensile failure strain
CFS	Compressive failure strain
OFFSET	Offset factor between 0 and 1.0 to determine permanent set upon unloading if the UNLOAD = 3.0. The permanent sets in compression and tension are equal to the product of this offset value and the maximum compressive and tensile displacements, respectively.
IVS	Initial volume strain

***EOS_MIE_GRUNEISEN**

This is Equation of State Form 16, a Mie-Gruneisen form with a $p - \alpha$ compaction model.

Card 1	1	2	3	4	5	6	7	8
Variable	EOSID	GAMMA	A1	A2	A3	PEL	PCO	N
Type	A	F	F	F	F	F	F	F
Default	none	none	none	none	none	none	none	none

Card 2	1	2	3	4	5	6	7	8
Variable	ALPHA0	E0	V0					
Type	F	F	F					
Default	none	none	none					

VARIABLE**DESCRIPTION**

EOSID	Equation of state identification. A unique number or label must be specified (see *PART).
GAMMA	Gruneisen gamma
A_i	Hugoniot polynomial coefficient
PEL	Crush pressure
PCO	Compaction pressure
N	Porosity exponent
ALPHA0	Initial porosity
E0	Initial internal energy
V0	Initial relative volume

Remarks:

The equation of state is a Mie-Gruneisen form with a polynomial Hugoniot curve and a $p - \alpha$ compaction model. First, we define a history variable representing the porosity α that is initialised to $\alpha_0 > 1$. The evolution of this variable is given as

$$\alpha(t) = \max \left\{ 1, \min \left[\alpha_0, \min_{s \leq t} \left(1 + (\alpha_0 - 1) \left[\frac{p_{\text{comp}} - p(s)}{p_{\text{comp}} - p_{el}} \right]^N \right) \right] \right\},$$

where $p(t)$ indicates the pressure at time t . For later use, we define the cap pressure as

$$p_c = p_{\text{comp}} - (p_{\text{comp}} - p_{el}) \left[\frac{\alpha - 1}{\alpha_0 - 1} \right]^{\frac{1}{N}}.$$

The remainder of the EOS model is given by the equations

$$p(\rho, e) = \Gamma \alpha \rho e + p_H(\eta) \left[1 - \frac{1}{2} \Gamma \eta \right]$$

$$p_H(\eta) = A_1 \eta + A_2 \eta^2 + A_3 \eta^3$$

together with

$$\eta(\rho) = \frac{\alpha \rho}{\alpha_0 \rho_0} - 1.$$

***EOS_MURNAGHAN**

This is Equation of State Form 19. This EOS was designed to model incompressible fluid flow with SPH or ALE elements.

Card 1	1	2	3	4	5	6	7	8
Variable	EOSID	GAMMA	K0	V0				
Type	A	F	F	F				

VARIABLE**DESCRIPTION**

EOSID	Equation of state ID. A unique number or label must be specified (see *PART).
GAMMA, K0	Constants in the equation of state
V0	Initial relative volume

Remarks:

The Murnaghan equation of state defines pressure as

$$p = k_0 \left[\left(\frac{\rho}{\rho_0} \right)^\gamma - 1 \right] .$$

To model fluid flows accurately, γ is often set to 7, and k_0 is chosen such that

$$c_0 = \sqrt{\frac{\gamma k_0}{\rho_0}} \geq 10v_{\max} ,$$

where v_{\max} is the maximum expected fluid flow velocity. This will ensure low compressibility while allowing for a relatively large time step size.

***EOS_USER_DEFINED**

These are Equations of State 21-30. The user can supply his own subroutines. See also Appendix B. The keyword input must be used for the user interface with data.

Card 1	1	2	3	4	5	6	7	8
Variable	EOSID	EOST	LMC	NHV	IVECT	E0	V0	BULK
Type	A	I	I	I	I	F	F	F

Define LMC material parameters using 8 parameters per card.

Card 2	1	2	3	4	5	6	7	8
Variable	P1	P2	P3	P4	P5	P6	P7	P8
Type	F	F	F	F	F	F	F	F

VARIABLE**DESCRIPTION**

EOSID	Equation of state ID. A unique number or label must be specified (see *PART).
EOST	User equation of state type (21-30 inclusive). A number between 21 and 30 has to be chosen.
LMC	Length of material constant array which is equal to the number of material constants to be input. ($LMC \leq 48$)
NHV	Number of history variables to be stored, see Appendix B.
IVECT	Vectorization flag (on = 1). A vectorized user subroutine must be supplied.
E0	Initial internal energy
V0	Initial relative volume
BULK	Bulk modulus. This value is used in the calculation of the contact surface stiffness.
P_i	Material parameters $i = 1, \dots, LMC$.

***EOS_USER_LIBRARY**

This is Equation of State Form 42.

Purpose: Select a material ID defined in a library called `seslib`, and initialize the thermodynamic state of the material by defining `E0` and `V0` below. `seslib` must be in the working directory.

Card 1	1	2	3	4	5	6	7	8
Variable	EOSID	SESMID						
Type	A	I						

Card 2	1	2	3	4	5	6	7	8
Variable	E0	V0						
Type	F	F						

VARIABLE

DESCRIPTION

EOSID	Equation of state ID. A unique number or label must be specified (see *PART).
SESMID	Material ID
E0	Initial internal energy per unit reference volume (see the beginning of the *EOS section)
V0	Initial relative volume (see the beginning of the *EOS section)

*MAT

LS-DYNA has historically referenced each material model by a number. As shown below, a three digit numerical designation can still be used, e.g., *MAT_001, and is equivalent to a corresponding descriptive designation, e.g., *MAT_ELASTIC. The two equivalent commands for each material model, one numerical and the other descriptive, are listed below. The numbers in square brackets (see key below) identify the element formulations for which the material model is implemented. The number in the curly brackets, {*n*}, indicates the default number of history variables per element integration point that are stored in addition to the 7 history variables which are stored by default. Just as an example, for the type 16 fully integrated shell elements with 2 integration points through the thickness, the total number of history variables is $8 \times (n + 7)$. For the Belytschko-Tsay type 2 element the number is $2 \times (n + 7)$.

The meaning associated with particular extra history variables for a subset of material models and equations of state are tabulated at <http://www.dynasupport.com/howtos/material/history-variables>.

An additional option **TITLE** may be appended to a *MAT keyword in which case an additional line is read in 80a format which can be used to describe the material. At present, LS-DYNA does not make use of the title. Inclusion of titles simply gives greater clarity to input decks.

Key to numbers in square brackets

0	-	Solids (and 2D continuum elements, that is, shell formulations 13, 14, 15)
1H	-	Hughes-Liu beam
1B	-	Belytschko resultant beam
1I	-	Belytschko integrated solid and tubular beams
1T	-	Truss
1D	-	Discrete beam
1SW	-	Spotweld beam
2	-	Shells
3a	-	Thick shell formulations 1, 2, 6
3c	-	Thick shell formulations 3, 5, 7
4	-	Special airbag element
5	-	SPH element (particle)
6	-	Acoustic solid
7	-	Cohesive solid
8A	-	Multi-material ALE solid (validated)

*MAT

- 8B - Multi-material ALE solid (implemented but not validated¹)
- 9 - Membrane element
- 10 - SPR2/SPR3 connectors
- 11 - Peridynamics element
- 12 - Incompressible SPG

*MAT_ADD_AIRBAG_POROSITY_LEAKAGE²

*MAT_ADD_CHEM_SHRINKAGE²

*MAT_ADD_COHESIVE² [7] {see associated material model}

*MAT_ADD_DAMAGE_DIEM² [0,2]

*MAT_ADD_DAMAGE_GISSMO² [0,1H,2,3a,3c,5]

*MAT_ADD_EROSION² [0,1H,2,3a,3c,5,7]

*MAT_ADD_FATIGUE²

*MAT_ADD_GENERALIZED_DAMAGE² [0,2]

*MAT_ADD_INELASTICITY²

*MAT_ADD_PERMEABILITY²

*MAT_ADD_PORE_AIR²

*MAT_ADD_PROPERTY_DEPENDENCE²

*MAT_ADD_PZELECTRIC² [0,3c]

*MAT_ADD_SOC_EXPANSION² [0]

*MAT_ADD_THERMAL_EXPANSION²

*MAT_NONLOCAL²

*MAT_001: *MAT_ELASTIC [0,1H,1B,1I,1T,2,3a,3c,5,8A] {0}

*MAT_001_FLUID: *MAT_ELASTIC_FLUID [0,8A] {0}

*MAT_002: *MAT_OPTIONTROPIC_ELASTIC [0,2,3a,3c] {15}

*MAT_003: *MAT_PLASTIC_KINEMATIC [0,1H,1I,1T,2,3a,3c,5,8A] {5}

*MAT_004: *MAT_ELASTIC_PLASTIC_THERMAL [0,1H,1T,2,3a,3c,5,8B] {3}

*MAT_005: *MAT_SOIL_AND_FOAM [0,5,3c,8A] {0}

*MAT_006: *MAT_VISCOELASTIC [0,1H,2,3a,3c,5,8B] {19}

*MAT_007: *MAT_BLATZ-KO_RUBBER [0,2,3ac,8B] {9}

*MAT_008: *MAT_HIGH_EXPLOSIVE_BURN [0,5,3c,8A] {4}

*MAT_009: *MAT_NULL [0,1,2,3c,5,8A] {3}

*MAT_010: *MAT_ELASTIC_PLASTIC_HYDRO_{OPTION} [0,3c,5,8B] {4}

*MAT_011: *MAT_STEINBERG [0,3c,5,8B] {5}

*MAT_011_LUND: *MAT_STEINBERG_LUND [0,3c,5,8B] {5}

*MAT_012: *MAT_ISOTROPIC_ELASTIC_PLASTIC [0,2,3a,3c,5,8B] {0}

*MAT_013: *MAT_ISOTROPIC_ELASTIC_FAILURE [0,3c,5,8B] {1}

*MAT_014: *MAT_SOIL_AND_FOAM_FAILURE [0,3c,5,8B] {1}

*MAT_015: *MAT_JOHNSON_COOK [0,2,3a,3c,5,8A] {6}

*MAT_016: *MAT_PSEUDO_TENSOR [0,3c,5,8B] {6}

¹ Error associated with advection inherently leads to state variables that may be inconsistent with nonlinear constitutive routines and thus may lead to nonphysical results, nonconservation of energy, and even numerical instability in some cases. Caution is advised, particularly when using the 2nd tier of material models implemented for ALE multi-material solids (designated by [8B]) which are largely untested as ALE materials.

² These commands do not, by themselves, define a material model but rather can be used in certain cases to supplement material models.

*MAT_017:	*MAT_ORIENTED_CRACK [0,3c] {14}
*MAT_018:	*MAT_POWER_LAW_PLASTICITY [0,1H,2,3a,3c,5,8B] {0}
*MAT_019:	*MAT_STRAIN_RATE_DEPENDENT_PLASTICITY [0,2,3a,3c,5,8B] {6}
*MAT_020:	*MAT_RIGID [0,1H,1B,1T,2,3a] {0}
*MAT_021:	*MAT_ORTHOTROPIC_THERMAL [0,2,3ac] {29}
*MAT_022:	*MAT_COMPOSITE_DAMAGE [0,2,3a,3c,5] {12}
*MAT_023:	*MAT_TEMPERATURE_DEPENDENT_ORTHOTROPIC [0,2,3ac] {19}
*MAT_024:	*MAT_PIECEWISE_LINEAR_PLASTICITY [0,1H,2,3a,3c,5,8A] {5}
*MAT_025:	*MAT_GEOLOGIC_CAP_MODEL [0,3c,5] {12}
*MAT_026:	*MAT_HONEYCOMB [0,3c] {20}
*MAT_027:	*MAT_MOONEY-RIVLIN_RUBBER [0,1T,2,3c,8B] {9}
*MAT_028:	*MAT_RESULTANT_PLASTICITY [1B,2] {5}
*MAT_029:	*MAT_FORCE_LIMITED [1B] {30}
*MAT_030:	*MAT_SHAPE_MEMORY [0,1H,2,3ac,5] {23}
*MAT_031:	*MAT_FRAZER_NASH_RUBBER_MODEL [0,3c,8B] {9}
*MAT_032:	*MAT_LAMINATED_GLASS [2,3a] {0}
*MAT_033:	*MAT_BARLAT_ANISOTROPIC_PLASTICITY [0,2,3a,3c] {9}
*MAT_033_96:	*MAT_BARLAT_YLD96 [2,3a] {9}
*MAT_034:	*MAT_FABRIC [4] {29}
*MAT_034M:	*MAT_FABRIC_MAP [4] {17}
*MAT_035:	*MAT_PLASTIC_GREEN-NAGHDI_RATE [0,3c,5,8B] {22}
*MAT_036:	*MAT_3-PARAMETER_BARLAT [2,3a,3c] {7}
*MAT_036E:	*MAT_EXTENDED_3-PARAMETER_BARLAT [2,3a,3c] {7}
*MAT_037:	*MAT_TRANSVERSELY_ANISOTROPIC_ELASTIC_PLASTIC [2,3a] {9}
*MAT_038:	*MAT_BLATZ-KO_FOAM [0,2,3c,8B] {9}
*MAT_039:	*MAT_FLD_TRANSVERSELY_ANISOTROPIC [2,3a] {6}
*MAT_040:	*MAT_NONLINEAR_ORTHOTROPIC [0,2,3c] {17}
*MAT_041-050:	*MAT_USER_DEFINED_MATERIAL_MODELS [0,1H,1T,1D,2,3a,3c,5,8B] {0}
*MAT_051:	*MAT_BAMMAN [0,2,3a,3c,5,8B] {8}
*MAT_052:	*MAT_BAMMAN_DAMAGE [0,2,3a,3c,5,8B] {10}
*MAT_053:	*MAT_CLOSED_CELL_FOAM [0,3c,8B] {0}
*MAT_054-055:	*MAT_ENHANCED_COMPOSITE_DAMAGE [0,2,3a,3c] {20}
*MAT_057:	*MAT_LOW_DENSITY_FOAM [0,3c,5,8B] {26}
*MAT_058:	*MAT_LAMINATED_COMPOSITE_FABRIC [0,2,3a] {15}
*MAT_059:	*MAT_COMPOSITE_FAILURE_{OPTION}_MODEL [0,2,3c,5] {22}
*MAT_060:	*MAT_ELASTIC_WITH_VISCOSITY [0,2,3a,3c,5,8B] {8}
*MAT_060C:	*MAT_ELASTIC_WITH_VISCOSITY_CURVE [0,2,3a,3c,5,8B] {8}
*MAT_061:	*MAT_KELVIN-MAXWELL_VISCOELASTIC [0,3c,5,8B] {14}
*MAT_062:	*MAT_VISCOUS_FOAM [0,3c,8B] {7}
*MAT_063:	*MAT_CRUSHABLE_FOAM [0,3c,5,8B] {8}
*MAT_064:	*MAT_RATE_SENSITIVE_POWERLAW_PLASTICITY [0,2,3a,3c,5,8B] {30}
*MAT_065:	*MAT_MODIFIED_ZERILLI_ARMSTRONG [0,2,3a,3c,5,8B] {6}
*MAT_066:	*MAT_LINEAR_ELASTIC_DISCRETE_BEAM [1D] {8}
*MAT_067:	*MAT_NONLINEAR_ELASTIC_DISCRETE_BEAM [1D] {14}
*MAT_068:	*MAT_NONLINEAR_PLASTIC_DISCRETE_BEAM [1D] {25}
*MAT_069:	*MAT_SID_DAMPER_DISCRETE_BEAM [1D] {13}
*MAT_070:	*MAT_HYDRAULIC_GAS_DAMPER_DISCRETE_BEAM [1D] {8}
*MAT_071:	*MAT_CABLE_DISCRETE_BEAM [1D] {8}
*MAT_072:	*MAT_CONCRETE_DAMAGE [0,3c,5,8B] {6}
*MAT_072R3:	*MAT_CONCRETE_DAMAGE_REL3 [0,3c,5] {6}
*MAT_073:	*MAT_LOW_DENSITY_VISCOUS_FOAM [0,3c,8B] {56}
*MAT_074:	*MAT_ELASTIC_SPRING_DISCRETE_BEAM [1D] {8}
*MAT_075:	*MAT_BILKHU/DUBOIS_FOAM [0,3c,5,8B] {8}
*MAT_076:	*MAT_GENERAL_VISCOELASTIC [0,2,3a,3c,5,8B] {53}

*MAT

*MAT_077_H:	*MAT_HYPERELASTIC_RUBBER [0,2,3c,5,8B] {54}
*MAT_077_O:	*MAT_OGDEN_RUBBER [0,2,3c,5,8B] {54}
*MAT_078:	*MAT_SOIL_CONCRETE [0,3c,5,8B] {3}
*MAT_079:	*MAT_HYSTERETIC_SOIL [0,3c,5,8B] {96}
*MAT_080:	*MAT_RAMBERG-OSGOOD [0,3c,8B] {18}
*MAT_081:	*MAT_PLASTICITY_WITH_DAMAGE [0,2,3a,3c] {5}
*MAT_082(_RCDC):	*MAT_PLASTICITY_WITH_DAMAGE_ORTHO(_RCDC) [0,2,3a,3c] {22}
*MAT_083:	*MAT_FU_CHANG_FOAM [0,3c,5,8B] {54}
*MAT_084:	*MAT_WINFRITH_CONCRETE [0] {54}
*MAT_086:	*MAT_ORTHOTROPIC_VISCOELASTIC [2,3a] {17}
*MAT_087:	*MAT_CELLULAR_RUBBER [0,3c,5,8B] {19}
*MAT_088:	*MAT_MTS [0,2,3a,3c,5,8B] {5}
*MAT_089:	*MAT_PLASTICITY_POLYMER [0,2,3a,3c] {46}
*MAT_090:	*MAT_ACOUSTIC [6] {25}
*MAT_091:	*MAT_SOFT_TISSUE [0,2] {16}
*MAT_092:	*MAT_SOFT_TISSUE_VISCO [0,2] {58}
*MAT_093:	*MAT_ELASTIC_6DOF_SPRING_DISCRETE_BEAM [1D] {25}
*MAT_094:	*MAT_INELASTIC_SPRING_DISCRETE_BEAM [1D] {9}
*MAT_095:	*MAT_INELASTIC_6DOF_SPRING_DISCRETE_BEAM [1D] {25}
*MAT_096:	*MAT_BRITTLE_DAMAGE [0,8B] {51}
*MAT_097:	*MAT_GENERAL_JOINT_DISCRETE_BEAM [1D] {23}
*MAT_098:	*MAT_SIMPLIFIED_JOHNSON_COOK [0,1H,1B,1T,2,3a,3c] {6}
*MAT_099:	*MAT_SIMPLIFIED_JOHNSON_COOK_ORTHOTROPIC_DAMAGE [0,2,3a,3c] {22}
*MAT_100:	*MAT_SPOTWELD_{OPTION} [0,1SW] {6}
*MAT_100_DA:	*MAT_SPOTWELD_DAIMLERCHRYSLER [0] {6}
*MAT_101:	*MAT_GEPLASTIC_SRATE_2000a [2,3a] {15}
*MAT_102(_T):	*MAT_INV_HYPERBOLIC_SIN(_THERMAL) [0,3c,8B] {15}
*MAT_103:	*MAT_ANISOTROPIC_VISCOPLASTIC [0,2,3a,3c,5] {20}
*MAT_103_P:	*MAT_ANISOTROPIC_PLASTIC [2,3a,3c] {20}
*MAT_104:	*MAT_DAMAGE_1 [0,2,3a,3c] {11}
*MAT_105:	*MAT_DAMAGE_2 [0,2,3a,3c] {7}
*MAT_106:	*MAT_ELASTIC_VISCOPLASTIC_THERMAL [0,2,3a,3c,5] {20}
*MAT_107:	*MAT_MODIFIED_JOHNSON_COOK [0,2,3a,3c,5,8B] {15}
*MAT_108:	*MAT_ORTHO_ELASTIC_PLASTIC [2,3a] {15}
*MAT_110:	*MAT_JOHNSON_HOLMQUIST_CERAMICS [0,3c,5] {15}
*MAT_111:	*MAT_JOHNSON_HOLMQUIST_CONCRETE [0,3c,5] {25}
*MAT_112:	*MAT_FINITE_ELASTIC_STRAIN_PLASTICITY [0,3c,5] {22}
*MAT_113:	*MAT_TRIP [2,3a] {5}
*MAT_114:	*MAT_LAYERED_LINEAR_PLASTICITY [2,3a] {13}
*MAT_115:	*MAT_UNIFIED_CREEP [0,2,3a,3c,5] {1}
*MAT_115_O:	*MAT_UNIFIED_CREEP_ORTHO [0,3c,5] {1}
*MAT_116:	*MAT_COMPOSITE_LAYUP [2] {30}
*MAT_117:	*MAT_COMPOSITE_MATRIX [2] {30}
*MAT_118:	*MAT_COMPOSITE_DIRECT [2] {10}
*MAT_119:	*MAT_GENERAL_NONLINEAR_6DOF_DISCRETE_BEAM [1D] {62}
*MAT_120:	*MAT_GURSON [0,2,3a,3c] {12}
*MAT_120_JC:	*MAT_GURSON_JC [0,2] {12}
*MAT_120_RCDC:	*MAT_GURSON_RCDC [0,2] {12}
*MAT_121:	*MAT_GENERAL_NONLINEAR_1DOF_DISCRETE_BEAM [1D] {20}
*MAT_122:	*MAT_HILL_3R [2,3a] {8}
*MAT_122_3D:	*MAT_HILL_3R_3D [0] {28}
*MAT_122_TAB:	*MAT_HILL_3R_TABULATED [2,3a] {8}
*MAT_123:	*MAT_MODIFIED_PIECEWISE_LINEAR_PLASTICITY [0,2,3a,3c,5] {11}
*MAT_124:	*MAT_PLASTICITY_COMPRESSION_TENSION [0,1H,2,3a,3c,5,8B] {7}

*MAT_125:	*MAT_KINEMATIC_HARDENING_TRANSVERSELY_ANISOTROPIC [0,2,3a,3c] {11}
*MAT_126:	*MAT_MODIFIED_HONEYCOMB [0,3c] {20}
*MAT_127:	*MAT_ARRUDA_BOYCE_RUBBER [0,3c,5] {49}
*MAT_128:	*MAT_HEART_TISSUE [0,3c] {15}
*MAT_129:	*MAT_LUNG_TISSUE [0,3c] {49}
*MAT_130:	*MAT_SPECIAL_ORTHOTROPIC [2] {35}
*MAT_131:	*MAT_ISOTROPIC_SMEARED_CRACK [0,5,8B] {15}
*MAT_132:	*MAT_ORTHOTROPIC_SMEARED_CRACK [0] {61}
*MAT_133:	*MAT_BARLAT_YLD2000 [0,2,3a,3c] {9}
*MAT_134:	*MAT_VISCOELASTIC_FABRIC [9]
*MAT_135:	*MAT_WTM_STM [2,3a,3c] {30}
*MAT_135_PLC:	*MAT_WTM_STM_PLC [2,3a] {30}
*MAT_136:	*MAT_VEGTER [2,3a] {5}
*MAT_136_STD:	*MAT_VEGTER_STANDARD [2,3a] {5}
*MAT_136_2017:	*MAT_VEGTER_2017 [2,3a] {5}
*MAT_138:	*MAT_COHESIVE_MIXED_MODE [7] {0}
*MAT_139:	*MAT_MODIFIED_FORCE_LIMITED [1B] {35}
*MAT_140:	*MAT_VACUUM [0,8A] {0}
*MAT_141:	*MAT_RATE_SENSITIVE_POLYMER [0,3c,8B] {6}
*MAT_142:	*MAT_TRANSVERSELY_ISOTROPIC_CRUSHABLE_FOAM [0,3c] {12}
*MAT_143:	*MAT_WOOD_{OPTION} [0,3c,5] {37}
*MAT_144:	*MAT_PITZER_CRUSHABLE_FOAM [0,3c,8B] {7}
*MAT_145:	*MAT_SCHWER_MURRAY_CAP_MODEL [0,5] {50}
*MAT_146:	*MAT_1DOF_GENERALIZED_SPRING [1D] {1}
*MAT_147:	*MAT_FHWA_SOIL [0,3c,5,8B] {15}
*MAT_147_N:	*MAT_FHWA_SOIL_NEBRASKA [0,3c,5,8B] {15}
*MAT_148:	*MAT_GAS_MIXTURE [0,8A] {14}
*MAT_151:	*MAT_EMMI [0,3c,5,8B] {23}
*MAT_153:	*MAT_DAMAGE_3 [0,1H,2,3a,3c]
*MAT_154:	*MAT_DESPANDE_FLECK_FOAM [0,3c,8B] {10}
*MAT_155:	*MAT_PLASTICITY_COMPRESSION_TENSION_EOS [0,3c,5,8B] {16}
*MAT_156:	*MAT_MUSCLE [1T] {0}
*MAT_157:	*MAT_ANISOTROPIC_ELASTIC_PLASTIC [0,2,3a] {5}
*MAT_158:	*MAT_RATE_SENSITIVE_COMPOSITE_FABRIC [2,3a] {54}
*MAT_159:	*MAT_CSCM_{OPTION} [0,3c,5] {22}
*MAT_160:	*MAT_ALE_INCOMPRESSIBLE
*MAT_161:	*MAT_COMPOSITE_MSC [0] {34}
*MAT_162:	*MAT_COMPOSITE_DMGMSC [0] {40}
*MAT_163:	*MAT_MODIFIED_CRUSHABLE_FOAM [0,3c,5,8B] {10}
*MAT_164:	*MAT_BRAIN_LINEAR_VISCOELASTIC [0] {14}
*MAT_165:	*MAT_PLASTIC_NONLINEAR_KINEMATIC [0,2,3a,3c,8B] {8}
*MAT_166:	*MAT_MOMENT_CURVATURE_BEAM [1B] {54}
*MAT_167:	*MAT_MCCORMICK [0,3c,8B] {8}
*MAT_168:	*MAT_POLYMER [0,3c,8B] {60}
*MAT_169:	*MAT_ARUP_ADHESIVE [0] {30}
*MAT_170:	*MAT_RESULTANT_ANISOTROPIC [2,3a] {67}
*MAT_171:	*MAT_STEEL_CONCENTRIC_BRACE [1B] {35}
*MAT_172:	*MAT_CONCRETE_EC2 [1H,2,3a] {64}
*MAT_173:	*MAT_MOHR_COULOMB [0,3c,5] {52}
*MAT_174:	*MAT_RC_BEAM [1H] {22}
*MAT_175:	*MAT_VISCOELASTIC_THERMAL [0,2,3a,3c,5,8B] {86}
*MAT_176:	*MAT_QUASILINEAR_VISCOELASTIC [0,2,3a,3c,5,8B] {81}
*MAT_177:	*MAT_HILL_FOAM [0,3c] {12}
*MAT_178:	*MAT_VISCOELASTIC_HILL_FOAM [0,3c] {92}

*MAT

*MAT_179:	*MAT_LOW_DENSITY_SYNTHETIC_FOAM_{OPTION} [0,3c] {77}
*MAT_180:	*MAT_LOW_DENSITY_SYNTHETIC_FOAM_ORTHO [0,3c]
*MAT_181:	*MAT_SIMPLIFIED_RUBBER/FOAM_{OPTION} [0,2,3c] {39}
*MAT_183:	*MAT_SIMPLIFIED_RUBBER_WITH_DAMAGE [0,2,3c] {44}
*MAT_184:	*MAT_COHESIVE_ELASTIC [7] {0}
*MAT_185:	*MAT_COHESIVE_TH [7] {0}
*MAT_186:	*MAT_COHESIVE_GENERAL [7] {6}
*MAT_187:	*MAT_SAMP-1 [0,2,3a,3c] {38}
*MAT_187L:	*MAT_SAMP_LIGHT [0,2,3a,3c] {7}
*MAT_188:	*MAT_THERMO_ELASTO_VISCOPLASTIC_CREEP [0,2,3a,3c] {27}
*MAT_189:	*MAT_ANISOTROPIC_THERMOELASTIC [0,3c,8B] {21}
*MAT_190:	*MAT_FLD_3-PARAMETER_BARLAT [2,3a] {36}
*MAT_191:	*MAT_SEISMIC_BEAM [1B] {36}
*MAT_192:	*MAT_SOIL_BRICK [0,3c] {96}
*MAT_193:	*MAT_DRUCKER_PRAGER [0,3c] {24}
*MAT_194:	*MAT_RC_SHEAR_WALL [2,3a] {36}
*MAT_195:	*MAT_CONCRETE_BEAM [1H] {5}
*MAT_196:	*MAT_GENERAL_SPRING_DISCRETE_BEAM [1D] {25}
*MAT_197:	*MAT_SEISMIC_ISOLATOR [1D] {20}
*MAT_198:	*MAT_JOINTED_ROCK [0,3c] {31}
*MAT_199:	*MAT_BARLAT_YLD2004 [0,3c] {11}
*MAT_202:	*MAT_STEEL_EC3 [1H] {3}
*MAT_203:	*MAT_HYSTERETIC_REINFORCEMENT [1H,2,3a] {64}
*MAT_205:	*MAT_DISCRETE_BEAM_POINT_CONTACT [1D]
*MAT_207:	*MAT_SOIL_SANISAND [0]
*MAT_208:	*MAT_BOLT_BEAM [1D] {16}
*MAT_209:	*MAT_HYSTERETIC_BEAM [1B] {50}
*MAT_211:	*MAT_SPR_JLR [0] {60}
*MAT_213:	*MAT_COMPOSITE_TABULATED_PLASTICITY_DAMAGE [0,2] {54}
*MAT_214:	*MAT_DRY_FABRIC [9]
*MAT_215:	*MAT_4A_MICROMECH [0,2,3a,3c]
*MAT_216:	*MAT_ELASTIC_PHASE_CHANGE [0]
*MAT_217:	*MAT_ORTHOTROPIC_ELASTIC_PHASE_CHANGE [2]
*MAT_218:	*MAT_MOONEY-RIVLIN_PHASE_CHANGE [0]
*MAT_219:	*MAT_CODAM2 [0,2,3a,3c]
*MAT_220:	*MAT_RIGID_DISCRETE [0,2]
*MAT_221:	*MAT_ORTHOTROPIC_SIMPLIFIED_DAMAGE [0,3c,5] {17}
*MAT_224:	*MAT_TABULATED_JOHNSON_COOK [0,2,3a,3c,,5] {17}
*MAT_224_GYS:	*MAT_TABULATED_JOHNSON_COOK_GYS [0] {17}
*MAT_225:	*MAT_VISCOPLASTIC_MIXED_HARDENING [0,2,3a,3c,5]
*MAT_226:	*MAT_KINEMATIC_HARDENING_BARLAT89 [2,3a]
*MAT_230:	*MAT_PML_ELASTIC [0] {24}
*MAT_231:	*MAT_PML_ACOUSTIC [6] {35}
*MAT_232:	*MAT_BIOT_HYSTERETIC [0,2,3a] {30}
*MAT_233:	*MAT_CAZACU_BARLAT [2,3a]
*MAT_234:	*MAT_VISCOELASTIC_LOOSE_FABRIC [2,3a]
*MAT_235:	*MAT_MICROMECHANICS_DRY_FABRIC [2,3a]
*MAT_236:	*MAT_SCC_ON_RCC [2,3a]
*MAT_237:	*MAT_PML_HYSTERETIC [0] {54}
*MAT_238:	*MAT_PERT_PIECEWISE_LINEAR_PLASTICITY [0,1H,2,3,5,8A]
*MAT_240:	*MAT_COHESIVE_MIXED_MODE_ELASTOPLASTIC_RATE [7] {17}
*MAT_241:	*MAT_JOHNSON_HOLMQUIST_JH1 [0,3c,5]
*MAT_242:	*MAT_KINEMATIC_HARDENING_BARLAT2000 [2,3a]
*MAT_243:	*MAT_HILL_90 [2,3a,3c]

*MAT_244:	*MAT_UHS_STEEL [0,2,3a,3c,5] {35}
*MAT_245:	*MAT_PML_{OPTION}TROPIC_ELASTIC [0] {30}
*MAT_246:	*MAT_PML_NULL [0] {27}
*MAT_248:	*MAT_PHS_BMW [2] {38}
*MAT_249:	*MAT_REINFORCED_THERMOPLASTIC [2]
*MAT_249_CRASH:	*MAT_REINFORCED_THERMOPLASTIC_CRASH [2]
*MAT_249_UDFIBER:	*MAT_REINFORCED_THERMOPLASTIC_UDFIBER [2]
*MAT_251:	*MAT_TAILORED_PROPERTIES [2] {6}
*MAT_252:	*MAT_TOUGHENED_ADHESIVE_POLYMER [0,7] {10}
*MAT_254:	*MAT_GENERALIZED_PHASE_CHANGE [0,2]
*MAT_255:	*MAT_PIECEWISE_LINEAR_PLASTIC_THERMAL [0,2,3a,3c]
*MAT_256:	*MAT_AMORPHOUS_SOLIDS_FINITE_STRAIN [0]
*MAT_258:	*MAT_NON_QUADRATIC_FAILURE [2]
*MAT_260A:	*MAT_STOUGHTON_NON_ASSOCIATED_FLOW [0,2]
*MAT_260B:	*MAT_MOHR_NON_ASSOCIATED_FLOW [2]
*MAT_261:	*MAT_LAMINATED_FRACTURE_DAIMLER_PINHO [0,2,3a,3c]
*MAT_262:	*MAT_LAMINATED_FRACTURE_DAIMLER_CAMANHO [0,2,3a,3c]
*MAT_263:	*MAT_LOU-YOON_ANISOTROPIC_PLASTICITY [0,2]
*MAT_264:	*MAT_TABULATED_JOHNSON_COOK_ORTHO_PLASTICITY [0]
*MAT_265:	*MAT_CONSTRAINED [10]
*MAT_266:	*MAT_TISSUE_DISPERSED [0]
*MAT_267:	*MAT_EIGHT_CHAIN_RUBBER [0,5]
*MAT_269:	*MAT_BERGSTROM_BOYCE_RUBBER [0,5]
*MAT_270:	*MAT_CWM [0,2,5]
*MAT_271:	*MAT_POWDER [0,5]
*MAT_272:	*MAT_RHT [0,5]
*MAT_273:	*MAT_CONCRETE_DAMAGE_PLASTIC_MODEL [0]
*MAT_274:	*MAT_PAPER [0,2]
*MAT_275:	*MAT_SMOOTH_VISCOELASTIC_VISCOPLASTIC [0]
*MAT_276:	*MAT_CHRONOLOGICAL_VISCOELASTIC [2,3a,3c]
*MAT_277:	*MAT_ADHESIVE_CURING_VISCOELASTIC [0,2]
*MAT_278:	*MAT_CF_MICROMECHANICS [0,2]
*MAT_279:	*MAT_COHESIVE_PAPER [7]
*MAT_280:	*MAT_GLASS [2,3a] {32}
*MAT_291:	*MAT_SHAPE_MEMORY_ALLOY [0] {20}
*MAT_292:	*MAT_ELASTIC_PERI [11]
*MAT_292A:	*MAT_ELASTIC_PERI_LAMINATE [11]
*MAT_293:	*MAT_COMPRF [2] {7}
*MAT_295:	*MAT_ANISOTROPIC_HYPERELASTIC [0] {9}
*MAT_296:	*MAT_ANAND_VISCOPLASTICITY [0]
*MAT_303:	*MAT_DMN_COMPOSITE_FRC [0,2]
*MAT_305:	*MAT_HOT_PLATE_ROLLING [0]{12}
*MAT_307:	*MAT_GENERALIZED_ADHESIVE_CURING [0,7]
*MAT_318:	*MAT_TNM_POLYMER [0] {21}
*MAT_319:	*MAT_IFPD [12]
*MAT_326:	*MAT_COHESIVE_GASKET [7] {0}

For discrete (type 6) beam elements, which are used to model complicated dampers and multi-dimensional spring-damper combinations, the following material types are available:

*MAT_066:	*MAT_LINEAR_ELASTIC_DISCRETE_BEAM
-----------	-----------------------------------

*MAT

*MAT_067:	*MAT_NONLINEAR_ELASTIC_DISCRETE_BEAM
*MAT_068:	*MAT_NONLINEAR_PLASTIC_DISCRETE_BEAM
*MAT_069:	*MAT_SID_DAMPER_DISCRETE_BEAM
*MAT_070:	*MAT_HYDRAULIC_GAS_DAMPER_DISCRETE_BEAM
*MAT_071:	*MAT_CABLE_DISCRETE_BEAM
*MAT_074:	*MAT_ELASTIC_SPRING_DISCRETE_BEAM
*MAT_093:	*MAT_ELASTIC_6DOF_SPRING_DISCRETE_BEAM
*MAT_094:	*MAT_INELASTIC_SPRING_DISCRETE_BEAM
*MAT_095:	*MAT_INELASTIC_6DOF_SPRING_DISCRETE_BEAM
*MAT_119:	*MAT_GENERAL_NONLINEAR_6DOF_DISCRETE_BEAM
*MAT_121:	*MAT_GENERAL_NONLINEAR_1DOF_DISCRETE_BEAM
*MAT_146:	*MAT_1DOF_GENERALIZED_SPRING
*MAT_196:	*MAT_GENERAL_SPRING_DISCRETE_BEAM
*MAT_197:	*MAT_SEISMIC_ISOLATOR
*MAT_205:	*MAT_DISCRETE_BEAM_POINT_CONTACT
*MAT_208:	*MAT_BOLT_BEAM

For discrete springs and dampers, the following material types are available:

*MAT_S01:	*MAT_SPRING_ELASTIC
*MAT_S02:	*MAT_DAMPER_VISCOUS
*MAT_S03:	*MAT_SPRING_ELASTOPLASTIC
*MAT_S04:	*MAT_SPRING_NONLINEAR_ELASTIC
*MAT_S05:	*MAT_DAMPER_NONLINEAR_VISCOUS
*MAT_S06:	*MAT_SPRING_GENERAL_NONLINEAR
*MAT_S07:	*MAT_SPRING_MAXWELL
*MAT_S08:	*MAT_SPRING_INELASTIC
*MAT_S13:	*MAT_SPRING_TRILINEAR_DEGRADING
*MAT_S14:	*MAT_SPRING_SQUAT_SHEARWALL
*MAT_S15:	*MAT_SPRING_MUSCLE

For ALE solids the following material types are available:

*MAT_ALE_01:	*MAT_ALE_VACUUM	(same as *MAT_140)
*MAT_ALE_02:	*MAT_ALE_GAS_MIXTURE	(same as *MAT_148)
*MAT_ALE_03:	*MAT_ALE_VISCOUS	(same as *MAT_009)
*MAT_ALE_04:	*MAT_ALE_MIXING_LENGTH	(same as *MAT_149)
*MAT_ALE_05:	*MAT_ALE_INCOMPRESSIBLE	(same as *MAT_160)
*MAT_ALE_06:	*MAT_ALE_HERSCHEL	

The following material type is only available for SPH particles:

*MAT_SPH_01:	*MAT_SPH_VISCOUS	(same as *MAT_009)
*MAT_SPH_02:	*MAT_SPH_INCOMPRESSIBLE_FLUID	
*MAT_SPH_03:	*MAT_SPH_INCOMPRESSIBLE_STRUCTURE	

In addition, most of the material types which are available for solids are also available for SPH. Those material models that may be used for SPH have a "5" included in square brackets in the list of materials given above. In the detailed descriptions of those materials which come later in the User's Manual, the word "solids" implies "solids and SPH".

For the seatbelts one material is available:

*MAT_B01: *MAT_SEATBELT

For thermal materials in a coupled structural/thermal or thermal only analysis, the following materials are available. These materials are related to the structural material through the *PART card.

*MAT_T01: *MAT_THERMAL_ISOTROPIC
*MAT_T02: *MAT_THERMAL_ORTHOTROPIC
*MAT_T03: *MAT_THERMAL_ISOTROPIC_TD
*MAT_T04: *MAT_THERMAL_ORTHOTROPIC_TD
*MAT_T05: *MAT_THERMAL_DISCRETE_BEAM
*MAT_T06: *MAT_THERMAL_CHEMICAL_REACTION
*MAT_T07: *MAT_THERMAL_CWM
*MAT_T08 *MAT_THERMAL_ORTHOTROPIC_TD_LC
*MAT_T09 *MAT_THERMAL_ISOTROPIC_PHASE_CHANGE
*MAT_T10 *MAT_THERMAL_ISOTROPIC_TD_LC
*MAT_T11-T15: *MAT_THERMAL_USER_DEFINED DEFINED
*MAT_T17: *MAT_THERMAL_CHEMICAL_REACTION_ORTHOTROPIC

Remarks:

Curves and tables are sometimes needed for defining material properties. An example would be a curve of effective stress as a function of effective plastic strain defined using the command *DEFINE_CURVE. In general, the following can be said about curves and tables that are referenced by material models:

1. Curves are internally rediscretized using equal increments along the x -axis.
2. Curve data is interpolated between rediscretized data points within the defined range of the curve and extrapolated as needed beyond the defined range of the curve.
3. Extrapolation is not employed for table value. See the manual entries for the *DEFINE_TABLE_... keywords.
4. See Remarks under *DEFINE_CURVE and *DEFINE_TABLE

MATERIAL MODEL REFERENCE TABLES

The tables provided on the following pages list the material models, some of their attributes, and the general classes of physical materials to which the numerical models might be applied.

If a material model, without consideration of *MAT_ADD_EROSION, *MAT_ADD_THERMAL_EXPANSION, *MAT_ADD_SOC_EXPANSION, *MAT_ADD_DAMAGE, *MAT_ADD_GENERALIZED_DAMAGE or *MAT_ADD_INELASTICITY, includes any of the following attributes, a "Y" will appear in the respective column of the table:

SRATE	- Strain-rate effects
FAIL	- Failure criteria
EOS	- Equation-of-State required for 3D solids and 2D continuum elements
THERMAL	- Thermal effects
ANISO	- Anisotropic/orthotropic
DAM	- Damage effects
TENS	- Tension handled differently than compression in some manner

Potential applications of the material models, in terms of classes of physical materials, are abbreviated in the table as follows:

GN	- General
CM	- Composite
CR	- Ceramic
FL	- Fluid
FM	- Foam
GL	- Glass
HY	- Hydrodynamic material
MT	- Metal
PL	- Plastic
RB	- Rubber
SL	- Soil, concrete, or rock
AD	- Adhesive or Cohesive material
BIO	- Biological material
CIV	- Civil Engineering component
HT	- Heat Transfer
F	- Fabric

MATERIAL MODEL REFERENCE TABLES

***MAT**

Material Number And Description		SRATE	FAIL	EOS	THERMAL	ANISO	DAM	TENS	APPS
1	Elastic								GN, FL
2	Orthotropic Elastic (Anisotropic-solids)					Y			CM, MT
3	Plastic Kinematic/Isotropic	Y	Y						CM, MT, PL
4	Elastic Plastic Thermal				Y				MT, PL
5	Soil and Foam							Y	FM, SL
6	Linear Viscoelastic	Y							RB
7	Blatz-Ko Rubber								RB
8	High Explosive Burn			Y					HY
9	Null Material	Y	Y	Y				Y	FL, HY
10	Elastic Plastic Hydro(dynamic)		Y	Y				Y	HY, MT
11	Steinberg: Temp. Dependent Elasto-plastic	Y	Y	Y	Y			Y	HY, MT
12	Isotropic Elastic Plastic								MT
13	Isotropic Elastic with Failure		Y					Y	MT
14	Soil and Foam with Failure		Y					Y	FM, SL
15	Johnson/Cook Plasticity Model	Y	Y	Y	Y		Y	Y	HY, MT
16	Pseudo Tensor Geological Model	Y	Y	Y			Y	Y	SL
17	Oriented Crack (Elastoplastic w/ Fracture)		Y	Y		Y		Y	HY, MT, PL, CR
18	Power Law Plasticity (Isotropic)	Y							MT, PL
19	Strain Rate Dependent Plasticity	Y	Y						MT, PL
20	Rigid								
21	Orthotropic Thermal (Elastic)				Y	Y			GN
22	Composite Damage		Y			Y		Y	CM
23	Temperature Dependent Orthotropic				Y	Y			CM
24	Piecewise Linear Plasticity (Isotropic)	Y	Y						MT, PL
25	Inviscid Two Invariant Geologic Cap		Y					Y	SL
26	Honeycomb	Y	Y			Y		Y	CM, FM, SL
27	Mooney-Rivlin Rubber							Y	RB
28	Resultant Plasticity								MT

Material Number And Description		SRATE	FAIL	EOS	THERMAL	ANISO	DAM	TENS	APPS
29	Force Limited Resultant Formulation							Y	
30	Shape Memory								MT
31	Frazer-Nash Rubber							Y	RB
32	Laminated Glass (Composite)		Y						CM, GL
33	Barlat Anisotropic Plasticity					Y			CR, MT
33_96	Barlat YLD96	Y				Y			MT
34	Fabric					Y		Y	F
35	Plastic-Green Naghdi Rate	Y							MT
36	Three-Parameter Barlat Plasticity	Y			Y	Y			MT
37	Transversely Anisotropic Elastic Plastic					Y			MT
38	Blatz-Ko Foam								FM, PL
39	FLD Transversely Anisotropic					Y			MT
40	Nonlinear Orthotropic		Y		Y	Y		Y	CM
41-50	User Defined Materials	Y	Y	Y	Y	Y	Y	Y	GN
51	Bamman (Temp/Rate Dependent Plasticity)	Y			Y				GN
52	Bamman Damage	Y	Y		Y		Y		MT
53	Closed cell foam (Low density polyurethane)								FM
54	Composite Damage with Chang Failure		Y			Y	Y	Y	CM
55	Composite Damage with Tsai-Wu Failure		Y			Y	Y	Y	CM
57	Low Density Urethane Foam	Y	Y					Y	FM
58	Laminated Composite Fabric		Y			Y	Y	Y	CM, F
59	Composite Failure (Plasticity Based)		Y			Y		Y	CM, CR
60	Elastic with Viscosity (Viscous Glass)	Y			Y				GL
61	Kelvin-Maxwell Viscoelastic	Y							FM
62	Viscous Foam (Crash dummy Foam)	Y							FM
63	Isotropic Crushable Foam	Y						Y	FM
64	Rate Sensitive Powerlaw Plasticity	Y							MT
65	Zerilli-Armstrong (Rate/Temp Plasticity)	Y		Y	Y			Y	MT
66	Linear Elastic Discrete Beam	Y				Y			

MATERIAL MODEL REFERENCE TABLES

***MAT**

Material Number And Description		SRATE	FAIL	EOS	THERMAL	ANISO	DAM	TENS	APPS
67	Nonlinear Elastic Discrete Beam	Y				Y		Y	
68	Nonlinear Plastic Discrete Beam	Y	Y			Y			
69	SID Damper Discrete Beam	Y							
70	Hydraulic Gas Damper Discrete Beam	Y							
71	Cable Discrete Beam (Elastic)							Y	Cables
72	Concrete Damage (incl. Release III)	Y	Y	Y			Y	Y	SL
73	Low Density Viscous Foam	Y	Y					Y	FM
74	Elastic Spring Discrete Beam	Y	Y					Y	
75	Bilkhu/Dubois Foam							Y	FM
76	General Viscoelastic (Maxwell Model)	Y			Y			Y	RB
77	Hyperelastic and Ogden Rubber	Y						Y	RB
78	Soil Concrete		Y				Y	Y	SL
79	Hysteretic Soil (Elasto-Perfectly Plastic)		Y					Y	SL
80	Ramberg-Osgood								SL
81	Plasticity with Damage	Y	Y				Y		MT, PL
82	Plasticity with Damage Ortho	Y	Y			Y	Y		
83	Fu Chang Foam	Y	Y				Y	Y	FM
84	Winfrith Concrete	Y						Y	FM, SL
86	Orthotropic Viscoelastic	Y				Y			RB
87	Cellular Rubber	Y						Y	RB
88	MTS	Y		Y	Y				MT
89	Plasticity Polymer	Y						Y	PL
90	Acoustic							Y	FL
91	Soft Tissue	Y	Y			Y		Y	BIO
92	Soft Tissue (viscous)								
93	Elastic 6DOF Spring Discrete Beam	Y	Y			Y		Y	
94	Inelastic Spring Discrete Beam	Y	Y					Y	
95	Inelastic 6DOF Spring Discrete Beam	Y	Y			Y		Y	
96	Brittle Damage	Y	Y			Y	Y	Y	SL
97	General Joint Discrete Beam								
98	Simplified Johnson Cook	Y	Y						MT
99	Simpl. Johnson Cook Orthotropic Damage	Y	Y			Y	Y		MT

Material Number And Description		SRATE	FAIL	EOS	THERMAL	ANISO	DAM	TENS	APPS
100	Spotweld	Y	Y				Y	Y	MT
101	GE Plastic Strain Rate	Y	Y					Y	PL
102(_T)	Inv. Hyperbolic Sin (Thermal)	Y			Y				MT, PL
103	Anisotropic Viscoplastic	Y	Y			Y			MT
103P	Anisotropic Plastic					Y			MT
104	Damage 1	Y	Y			Y	Y		MT
105	Damage 2	Y	Y				Y		MT
106	Elastic Viscoplastic Thermal	Y			Y				PL
107	Modified Johnson Cook	Y	Y		Y		Y		MT
108	Ortho Elastic Plastic					Y			
110	Johnson Holmquist Ceramics	Y	Y				Y	Y	CR, GL
111	Johnson Holmquist Concrete	Y	Y				Y	Y	SL
112	Finite Elastic Strain Plasticity	Y							PL
113	Transformation Induced Plasticity (TRIP)				Y				MT
114	Layered Linear Plasticity	Y	Y						MT, PL, CM
115	Unified Creep								GN
115_O	Unified Creep Ortho					Y			GN
116	Composite Layup					Y			CM
117	Composite Matrix					Y			CM
118	Composite Direct					Y			CM
119	General Nonlinear 6DOF Discrete Beam	Y	Y			Y		Y	
120	Gurson	Y	Y				Y	Y	MT
121	General Nonlinear 1DOF Discrete Beam	Y	Y					Y	
122	Hill 3RC					Y			MT
122_3D	Hill 3R 3D					Y			MT, CM
122_TAB	Hill 3R Tabulated					Y			MT
123	Modified Piecewise Linear Plasticity	Y	Y						MT, PL
124	Plasticity Compression Tension	Y	Y					Y	MT, PL
125	Kinematic Hardening Transversely Aniso.					Y			MT

MATERIAL MODEL REFERENCE TABLES

***MAT**

Material Number And Description		SRATE	FAIL	EOS	THERMAL	ANISO	DAM	TENS	APPS
126	Modified Honeycomb	Y	Y			Y	Y	Y	CM, FM, SL
127	Arruda Boyce Rubber	Y							RB
128	Heart Tissue					Y		Y	BIO
129	Lung Tissue	Y						Y	BIO
130	Special Orthotropic					Y			
131	Isotropic Smeared Crack		Y				Y	Y	MT, CM
132	Orthotropic Smeared Crack		Y			Y	Y		MT, CM
133	Barlat YLD2000	Y			Y	Y			MT
134	Viscoelastic Fabric								
135	Weak and Strong Texture Model	Y	Y			Y			MT
136	Vegter					Y			MT
136_STD	Vegter Standard Input	Y				Y			MT
136_2017	Vegter Simplified Input	Y				Y			MT
138	Cohesive Mixed Mode		Y			Y	Y	Y	AD
139	Modified Force Limited						Y	Y	
140	Vacuum								
141	Rate Sensitive Polymer	Y							PL
142	Transversely Isotropic Crushable Foam							Y	FM
143	Wood	Y	Y			Y	Y	Y	Wood
144	Pitzer Crushable Foam	Y						Y	FM
145	Schwer Murray Cap Model	Y	Y				Y	Y	SL
146	1DOF Generalized Spring	Y							
147	FWHA Soil	Y					Y	Y	SL
147N	FHWA Soil Nebraska	Y					Y	Y	SL
148	Gas Mixture				Y				FL
151	Evolving Microstructural Model of Inelast.	Y	Y		Y	Y	Y		MT
153	Damage 3	Y	Y				Y		MT, PL
154	Deshpande Fleck Foam		Y						FM
155	Plasticity Compression Tension EOS	Y	Y	Y				Y	Ice
156	Muscle	Y						Y	BIO
157	Anisotropic Elastic Plastic					Y			MT, CM

Material Number And Description		SRATE	FAIL	EOS	THERMAL	ANISO	DAM	TENS	APPS
158	Rate-Sensitive Composite Fabric	Y	Y			Y	Y	Y	CM
159	CSCM	Y	Y				Y	Y	SL
160	ALE incompressible								
161,162	Composite MSC (Dmg)	Y	Y			Y	Y	Y	CM
163	Modified Crushable Foam	Y						Y	FM
164	Brain Linear Viscoelastic	Y							BIO
165	Plastic Nonlinear Kinematic		Y						MT
166	Moment Curvature Beam	Y	Y					Y	CIV
167	McCormick	Y							MT
168	Polymer				Y			Y	PL
169	Arup Adhesive	Y	Y			Y		Y	AD
170	Resultant Anisotropic					Y			PL
171	Steel Concentric Brace						Y	Y	CIV
172	Concrete EC2		Y		Y			Y	SL, MT
173	Mohr Coulomb		Y			Y	Y	Y	SL
174	RC Beam						Y	Y	SL
175	Viscoelastic Thermal	Y			Y			Y	RB
176	Quasilinear Viscoelastic	Y	Y				Y	Y	BIO
177	Hill Foam							Y	FM
178	Viscoelastic Hill Foam (Ortho)	Y						Y	FM
179	Low Density Synthetic Foam	Y	Y			Y	Y	Y	FM
181	Simplified Rubber/Foam	Y	Y				Y	Y	RB, FM
183	Simplified Rubber with Damage	Y					Y	Y	RB
184	Cohesive Elastic		Y					Y	AD
185	Cohesive TH		Y			Y	Y	Y	AD
186	Cohesive General		Y			Y	Y	Y	AD
187	Semi-Analytical Model for Polymers – 1	Y	Y				Y	Y	PL
187L	SAMP light	Y						Y	PL
188	Thermo Elasto Viscoelastic Creep	Y			Y				MT
189	Anisotropic Thermoelastic				Y	Y			
190	Flow limit diagram 3-Parameter Barlat		Y			Y		Y	MT
191	Seismic Beam							Y	CIV

MATERIAL MODEL REFERENCE TABLES

***MAT**

Material Number And Description		SRATE	FAIL	EOS	THERMAL	ANISO	DAM	TENS	APPS
192	Soil Brick	Y				Y		Y	SL
193	Drucker Prager							Y	SL
194	RC Shear Wall		Y				Y	Y	CIV
195	Concrete Beam	Y	Y				Y	Y	CIV
196	General Spring Discrete Beam	Y						Y	
197	Seismic Isolator	Y	Y			Y		Y	CIV
198	Jointed Rock		Y			Y		Y	SL
199	Barlat YLD2004	Y				Y			MT
202	Steel EC3		Y		Y				CIV
203	Hysteretic Reinforcement		Y			Y	Y	Y	CIV
205	Discrete Beam Point Contact		Y					Y	GN, CIV
207	Simple ANIsotropic SAND (SANI-SAND)					Y		Y	SL
208	Bolt Beam		Y				Y	Y	MT
209	Hysteretic Beam		Y				Y	Y	CIV
211	SPR JLR	Y	Y						MT
213	Composite tabulated plasticity and damage	Y	Y		Y	Y	Y	Y	CM
214	Dry Fabric	Y	Y			Y	Y	Y	
215	4A Micromec	Y	Y			Y	Y		CM, PL
216	Elastic Phase Change								GN
217	Orthotropic Elastic Phase Change					Y			GN
218	Mooney Rivlin Rubber Phase Change							Y	RB
219	CODAM2		Y			Y	Y	Y	CM
220	Rigid Discrete								
221	Orthotropic Simplified Damage		Y			Y	Y	Y	CM
224	Tabulated Johnson Cook	Y	Y	Y	Y		Y	Y	HY, MT, PL
224_GYS	Tabulated Johnson Cook GYS	Y	Y	Y	Y		Y	Y	HY, MT, PL
225	Viscoplastic Mixed Hardening	Y	Y						MT, PL
226	Kinematic hardening Barlat 89					Y			MT
230	Elastic Perfectly Matched Layer (PML)	Y							SL

Material Number And Description		SRATE	FAIL	EOS	THERMAL	ANISO	DAM	TENS	APPS
231	Acoustic PML								FL
232	Biot Linear Hysteretic Material	Y							SL
233	Cazacu Barlat					Y		Y	MT
234	Viscoelastic Loose Fabric	Y	Y			Y		Y	F
235	Micromechanic Dry Fabric					Y		Y	F
236	SCC_on_RCC		Y			Y		Y	CM, CR
237	Biot Hysteretic PML	Y							SL
238	Piecewise linear plasticity (PERT)	Y	Y						MT, PL
240	Cohesive mixed mode	Y	Y			Y	Y	Y	AD
241	Johnson Holmquist JH1	Y	Y				Y	Y	CR, GL
242	Kinematic hardening Barlat 2000					Y			MT
243	Hill 90	Y			Y	Y			MT
244	UHS Steel	Y			Y				MT
245	Orthotropic/anisotropic PML	Y							SL
246	Null material PML			Y					FL
248	PHS BMW	Y			Y	Y			MT
249	Reinforced Thermoplastic				Y	Y		Y	CM, F
249_ CRASH	Reinforced Thermoplastic Crash		Y			Y	Y	Y	CM, F
249_ UDfiber	Reinforced Thermoplastic UDfiber				Y	Y		Y	CM, F
251	Tailored Properties	Y	Y						MT, PL
252	Toughened Adhesive Polymer	Y	Y		Y	Y	Y	Y	AD
254	Generalized Phase Change	Y			Y				MT
255	Piecewise linear plastic thermal	Y	Y		Y			Y	MT
256	Amorphous solid (finite strain)	Y						Y	GL
258	Non-quadratic failure	Y	Y				Y		MT
260A	Stoughton non-associated flow	Y				Y			MT
260B	Mohr non-associated flow	Y	Y		Y	Y	Y		MT
261	Laminated Fracture Daimler Pinho	Y	Y			Y	Y	Y	CM
262	Laminated Fracture Daimler Camanho	Y	Y			Y	Y	Y	CM
263	Anisotropic plasticity					Y			MT

Material Number And Description		SRATE	FAIL	EOS	THERMAL	ANISO	DAM	TENS	APPS
264	Tabulated Johnson Cook Orthotropic Plasticity	Y	Y	Y	Y	Y	Y	Y	HY, MT, PL
265	Constrained SPR2/SPR3		Y				Y		MT
266	Dispersed tissue					Y			BIO
267	Eight chain rubber	Y				Y			RB, PL
269	Bergström Boyce rubber	Y							RB
270	Welding material				Y				MT, PL
271	Powder compaction							Y	CR, SL
272	RHT concrete model	Y	Y				Y	Y	SL, CIV
273	Concrete damage plastic	Y	Y				Y	Y	SL
274	Paper					Y		Y	CM, PL
275	Smooth viscoelastic viscoplastic	Y							MT, PL
276	Chronological viscoelastic	Y			Y				RB
277	Adhesive curing viscoelastic	Y			Y				AD
278	CF Micromechanics	Y	Y		Y	Y			CM
279	Cohesive Paper		Y					Y	AD
280	Glass					Y	Y	Y	GL
291	Shape Memory Alloy				Y	Y		Y	MT
292	Isotropic Elastic for Peridynamic Solids		Y						GL, CR, PL, SL
292A	Elastic for Peridynamic Laminates		Y			Y			CM
293	COMPRF	Y				Y		Y	CM
295	Anisotropic hyperelastic					Y		Y	BIO, CM, RB
296	Soldering metal in semiconductor packaging	Y			Y				MT
303	Machine-learning base multiscale material model for fiber-reinforced composites					Y		Y	CM
305	Hot Plate Rolling	Y			Y				MT
307	Generalized Adhesive Curing	Y	Y		Y	Y	Y	Y	AD
318	TNM Polymer	Y			Y				PL
319	Incompressible Fluids with ISPG								FL
326	Gaskets							Y	AD

Material Number And Description		SRATE	FAIL	EOS	THERMAL	ANISO	DAM	TENS	APPS
A01	ALE Vacuum								FL
A02	ALE Gas Mixture				Y				FL
A03	ALE Viscous			Y				Y	FL
A04	ALE Mixing Length								FL
A05	ALE Incompressible								FL
A06	ALE Herschel			Y				Y	FL
SPH01	SPH Viscous			Y				Y	FL
SPH02	SPH Incompressible Fluid							Y	FL
SPH03	SPH Incompressible Structure								FL
S1	Spring Elastic (Linear)								
S2	Damper Viscous (Linear)	Y							
S3	Spring Elastoplastic (Isotropic)								
S4	Spring Nonlinear Elastic	Y						Y	
S5	Damper Nonlinear Viscous	Y						Y	
S6	Spring General Nonlinear							Y	
S7	Spring Maxwell (3-Parameter Viscoelastic)	Y							
S8	Spring Inelastic (Tension or Compression)							Y	
S13	Spring Trilinear Degrading		Y				Y		CIV
S14	Spring Squat Shearwall						Y		CIV
S15	Spring Muscle	Y						Y	BIO
B1	Seatbelt							Y	
T01	Thermal Isotropic				Y				HT
T02	Thermal Orthotropic				Y	Y			HT
T03	Thermal Isotropic (Temp Dependent)				Y				HT
T04	Thermal Orthotropic (Temp Dependent)				Y	Y			HT
T05	Thermal Discrete Beam				Y				HT
T06	Thermal chemical reaction				Y				HT
T07	Thermal CWM (Welding)				Y				HT
T08	Thermal Orthotropic(Temp dep-load curve)				Y	Y			HT
T09	Thermal Isotropic (Phase Change)				Y				HT

Material Number And Description		SRATE	FAIL	EOS	THERMAL	ANISO	DAM	TENS	APPS
T10	Thermal Isotropic (Temp dep-load curve)				Y				HT
T11	Thermal User Defined				Y				HT
T17	Thermal Chemical Reaction Orthotropic				Y	Y			HT

ALPHABETIZED MATERIALS LIST

Alphabetized Materials List

Material Keyword	Number
*EOS_GASKET	*EOS_015
*EOS_GRUNEISEN	*EOS_004
*EOS_IDEAL_GAS	*EOS_012
*EOS_IGNITION_AND_GROWTH_OF_REACTION_IN_HE	*EOS_007
*EOS_JWL	*EOS_002
*EOS_JWLB	*EOS_014
*EOS_LINEAR_POLYNOMIAL	*EOS_001
*EOS_LINEAR_POLYNOMIAL_WITH_ENERGY_LEAK	*EOS_006
*EOS_MIE_GRUNEISEN	*EOS_016
*EOS_MURNAGHAN	*EOS_019
*EOS_PHASE_CHANGE	*EOS_013
*EOS_PROPELLANT_DEFLAGRATION	*EOS_010
*EOS_RATIO_OF_POLYNOMIALS	*EOS_005
*EOS_SACK_TUESDAY	*EOS_003
*EOS_TABULATED	*EOS_009
*EOS_TABULATED_COMPACTION	*EOS_008
*EOS_TENSOR_PORE_COLLAPSE	*EOS_011
*EOS_USER_DEFINED	*EOS_021-*EOS_030
*MAT_{OPTION}TROPIC_ELASTIC	*MAT_002
*MAT_1DOF_GENERALIZED_SPRING	*MAT_146
*MAT_3-PARAMETER_BARLAT	*MAT_036
*MAT_4A_MICROMECH	*MAT_215
*MAT_ACOUSTIC	*MAT_090
*MAT_ADD_AIRBAG_POROSITY_LEAKAGE	
*MAT_ADD_CHEM_SHRINKAGE	
*MAT_ADD_COHESIVE	
*MAT_ADD_DAMAGE_DIEM	

ALPHABETIZED MATERIALS LIST

Material Keyword	Number
*MAT_ADD_DAMAGE_GISSMO	
*MAT_ADD_EROSION	
*MAT_ADD_FATIGUE	
*MAT_ADD_GENERALIZED_DAMAGE	
*MAT_ADD_PERMEABILITY	
*MAT_ADD_PORE_AIR	
*MAT_ADD_SOC_EXPANSION	
*MAT_ADD_THERMAL_EXPANSION	
*MAT_ADHESIVE_CURING_VISCOELASTIC	*MAT_277
*MAT_ALE_GAS_MIXTURE	*MAT_ALE_02
*MAT_ALE_HERSCHEL	*MAT_ALE_06
*MAT_ALE_INCOMPRESSIBLE	*MAT_160
*MAT_ALE_MIXING_LENGTH	*MAT_ALE_04
*MAT_ALE_VACUUM	*MAT_ALE_01
*MAT_ALE_VISCOIS	*MAT_ALE_03
*MAT_AMORPHOUS_SOLIDS_FINITE_STRAIN	*MAT_256
*MAT_ANAND_VISCOPLASTICITY	*MAT_296
*MAT_ANISOTROPIC_ELASTIC	*MAT_002_ANISO
*MAT_ANISOTROPIC_ELASTIC_PLASTIC	*MAT_157
*MAT_ANISOTROPIC_HYPERELASTIC	*MAT_295
*MAT_ANISOTROPIC_PLASTIC	*MAT_103_P
*MAT_ANISOTROPIC_THERMOELASTIC	*MAT_189
*MAT_ANISOTROPIC_VISCOPLASTIC	*MAT_103
*MAT_ARRUDA_BOYCE_RUBBER	*MAT_127
*MAT_ARUP_ADHESIVE	*MAT_169
*MAT_BAMMAN	*MAT_051
*MAT_BAMMAN_DAMAGE	*MAT_052
*MAT_BARLAT_ANISOTROPIC_PLASTICITY	*MAT_033
*MAT_BARLAT_YLD2000	*MAT_133
*MAT_BARLAT_YLD2004	*MAT_199

ALPHABETIZED MATERIALS LIST

Material Keyword	Number
*MAT_BARLAT_YLD96	*MAT_033_96
*MAT_BERGSTROM_BOYCE_RUBBER	*MAT_269
*MAT_BILKHU/DUBOIS_FOAM	*MAT_075
*MAT_BIOT_HYSTERETIC	*MAT_232
*MAT_BLATZ-KO_FOAM	*MAT_038
*MAT_BLATZ-KO_RUBBER	*MAT_007
*MAT_BOLT_BEAM	*MAT_208
*MAT_BRAIN_LINEAR_VISCOELASTIC	*MAT_164
*MAT_BRITTLE_DAMAGE	*MAT_096
*MAT_CABLE_DISCRETE_BEAM	*MAT_071
*MAT_CAZACU_BARLAT	*MAT_233
*MAT_CELLULAR_RUBBER	*MAT_087
*MAT_CF_MICROMECHANICS	*MAT_278
*MAT_CHRONOLOGICAL_VISCOELASTIC	*MAT_276
*MAT_CLOSED_CELL_FOAM	*MAT_053
*MAT_CODAM2	*MAT_219
*MAT_COHESIVE_ELASTIC	*MAT_184
*MAT_COHESIVE_GASKET	*MAT_326
*MAT_COHESIVE_GENERAL	*MAT_186
*MAT_COHESIVE_MIXED_MODE	*MAT_138
*MAT_COHESIVE_MIXED_MODE_ELASTOPLASTIC_RATE	*MAT_240
*MAT_COHESIVE_PAPER	*MAT_279
*MAT_COHESIVE_TH	*MAT_185
*MAT_COMPOSITE_DAMAGE	*MAT_022
*MAT_COMPOSITE_DIRECT	*MAT_118
*MAT_COMPOSITE_DMG_MSC	*MAT_162
*MAT_COMPOSITE_FAILURE_{OPTION}_MODEL	*MAT_059
*MAT_COMPOSITE_LAYUP	*MAT_116
*MAT_COMPOSITE_MATRIX	*MAT_117
*MAT_COMPOSITE_MSC	*MAT_161

ALPHABETIZED MATERIALS LIST

Material Keyword	Number
*MAT_COMPOSITE_TABULATED_PLASTICITY_DAMAGE	*MAT_213
*MAT_COMPRF	*MAT_293
*MAT_CONCRETE_BEAM	*MAT_195
*MAT_CONCRETE_DAMAGE	*MAT_072
*MAT_CONCRETE_DAMAGE_PLASTIC_MODEL	*MAT_273
*MAT_CONCRETE_DAMAGE_REL3	*MAT_072R3
*MAT_CONCRETE_EC2	*MAT_172
*MAT_CONSTRAINED	*MAT_265
*MAT_CRUSHABLE_FOAM	*MAT_063
*MAT_CSCM_{OPTION}	*MAT_159
*MAT_CWM	*MAT_270
*MAT_DAMAGE_1	*MAT_104
*MAT_DAMAGE_2	*MAT_105
*MAT_DAMAGE_3	*MAT_153
*MAT_DAMPER_NONLINEAR_VISCOUS	*MAT_S05
*MAT_DAMPER_VISCOUS	*MAT_S02
*MAT_DESHPANDE_FLECK_FOAM	*MAT_154
*MAT_DISCRETE_BEAM_POINT_CONTACT	*MAT_205
*MAT_DMN_COMPOSITE_FRC	*MAT_303
*MAT_DRUCKER_PRAGER	*MAT_193
*MAT_DRY_FABRIC	*MAT_214
*MAT_EIGHT_CHAIN_RUBBER	*MAT_267
*MAT_ELASTIC	*MAT_001
*MAT_ELASTIC_6DOF_SPRING_DISCRETE_BEAM	*MAT_093
*MAT_ELASTIC_FLUID	*MAT_001_FLUID
*MAT_ELASTIC_PERI	*MAT_292
*MAT_ELASTIC_PERI_LAMINATE	*MAT_292A
*MAT_ELASTIC_PHASE_CHANGE	*MAT_216
*MAT_ELASTIC_PLASTIC_HYDRO_{OPTION}	*MAT_010
*MAT_ELASTIC_PLASTIC_THERMAL	*MAT_004

ALPHABETIZED MATERIALS LIST

Material Keyword	Number
*MAT_ELASTIC_SPRING_DISCRETE_BEAM	*MAT_074
*MAT_ELASTIC_VISCOPLASTIC_THERMAL	*MAT_106
*MAT_ELASTIC_WITH_VISCOSITY	*MAT_060
*MAT_ELASTIC_WITH_VISCOSITY_CURVE	*MAT_060C
*MAT_EMMI	*MAT_151
*MAT_ENHANCED_COMPOSITE_DAMAGE	*MAT_054-055
*MAT_EXTENDED_3-PARAMETER_BARLAT	*MAT_036E
*MAT_FABRIC	*MAT_034
*MAT_FABRIC_MAP	*MAT_034M
*MAT_FHWA_SOIL	*MAT_147
*MAT_FHWA_SOIL_NEBRASKA	*MAT_147_N
*MAT_FINITE_ELASTIC_STRAIN_PLASTICITY	*MAT_112
*MAT_FLD_3-PARAMETER_BARLAT	*MAT_190
*MAT_FLD_TRANSVERSELY_ANISOTROPIC	*MAT_039
*MAT_FORCE_LIMITED	*MAT_029
*MAT_FRAZER_NASH_RUBBER_MODEL	*MAT_031
*MAT_FU_CHANG_FOAM	*MAT_083
*MAT_GAS_MIXTURE	*MAT_148
*MAT_GENERAL_JOINT_DISCRETE_BEAM	*MAT_097
*MAT_GENERAL_NONLINEAR_1DOF_DISCRETE_BEAM	*MAT_121
*MAT_GENERAL_NONLINEAR_6DOF_DISCRETE_BEAM	*MAT_119
*MAT_GENERAL_SPRING_DISCRETE_BEAM	*MAT_196
*MAT_GENERAL_VISCOELASTIC	*MAT_076
*MAT_GENERALIZED_ADHESIVE_CURING	*MAT_307
*MAT_GENERALIZED_PHASE_CHANGE	*MAT_254
*MAT_GEOLOGIC_CAP_MODEL	*MAT_025
*MAT_GEPLASTIC_SRATE_2000a	*MAT_101
*MAT_GLASS	*MAT_280
*MAT_GURSON	*MAT_120
*MAT_GURSON_JC	*MAT_120_JC

ALPHABETIZED MATERIALS LIST

Material Keyword	Number
*MAT_GURSON_RCDC	*MAT_120_RCDC
*MAT_HEART_TISSUE	*MAT_128
*MAT_HIGH_EXPLOSIVE_BURN	*MAT_008
*MAT_HILL_3R	*MAT_122
*MAT_HILL_3R_3D	*MAT_122_3D
*MAT_HILL_3R_TABULATED	*MAT_122_TAB
*MAT_HILL_90	*MAT_243
*MAT_HILL_FOAM	*MAT_177
*MAT_HONEYCOMB	*MAT_026
*MAT_HOT_PLATE_ROLLING	*MAT_305
*MAT_HYDRAULIC_GAS_DAMPER_DISCRETE_BEAM	*MAT_070
*MAT_HYPERELASTIC_RUBBER	*MAT_077_H
*MAT_HYSTERETIC_BEAM	*MAT_209
*MAT_HYSTERETIC_REINFORCEMENT	*MAT_203
*MAT_HYSTERETIC_SOIL	*MAT_079
*MAT_IFPD	*MAT_319
*MAT_INELASTC_6DOF_SPRING_DISCRETE_BEAM	*MAT_095
*MAT_INELASTIC_6DOF_SPRING_DISCRETE_BEAM	*MAT_095
*MAT_INELASTIC_SPRING_DISCRETE_BEAM	*MAT_094
*MAT_INV_HYPERBOLIC_SIN(_THERMAL)	*MAT_102(_T)
*MAT_ISOTROPIC_ELASTIC_FAILURE	*MAT_013
*MAT_ISOTROPIC_ELASTIC_PLASTIC	*MAT_012
*MAT_ISOTROPIC_SMEARED_CRACK	*MAT_131
*MAT_JOHNSON_COOK	*MAT_015
*MAT_JOHNSON_HOLMQUIST_CERAMICS	*MAT_110
*MAT_JOHNSON_HOLMQUIST_CONCRETE	*MAT_111
*MAT_JOHNSON_HOLMQUIST_JH1	*MAT_241
*MAT_JOINTED_ROCK	*MAT_198
*MAT_KELVIN-MAXWELL_VISCOELASTIC	*MAT_061
*MAT_KINEMATIC_HARDENING_BARLAT2000	*MAT_242

ALPHABETIZED MATERIALS LIST

Material Keyword	Number
*MAT_KINEMATIC_HARDENING_BARLAT89	*MAT_226
*MAT_KINEMATIC_HARDENING_TRANSVERSELY_ANISOTROPIC	*MAT_125
*MAT_LAMINATED_COMPOSITE_FABRIC	*MAT_058
*MAT_LAMINATED_FRACTURE_DAIMLER_CAMANHO	*MAT_262
*MAT_LAMINATED_FRACTURE_DAIMLER_PINHO	*MAT_261
*MAT_LAMINATED_GLASS	*MAT_032
*MAT_LAYERED_LINEAR_PLASTICITY	*MAT_114
*MAT_LINEAR_ELASTIC_DISCRETE_BEAM	*MAT_066
*MAT_LOU-YOON_ANISOTROPIC_PLASTICITY	*MAT_263
*MAT_LOW_DENSITY_FOAM	*MAT_057
*MAT_LOW_DENSITY_SYNTHETIC_FOAM_{OPTION}	*MAT_179
*MAT_LOW_DENSITY_VISCOUS_FOAM	*MAT_073
*MAT_LUNG_TISSUE	*MAT_129
*MAT_MCCORMICK	*MAT_167
*MAT_MICROMECHANICS_DRY_FABRIC	*MAT_235
*MAT_MODIFIED_CRUSHABLE_FOAM	*MAT_163
*MAT_MODIFIED_FORCE_LIMITED	*MAT_139
*MAT_MODIFIED_HONEYCOMB	*MAT_126
*MAT_MODIFIED_JOHNSON_COOK	*MAT_107
*MAT_MODIFIED_PIECEWISE_LINEAR_PLASTICITY	*MAT_123
*MAT_MODIFIED_ZERILLI_ARMSTRONG	*MAT_065
*MAT_MOHR_COULOMB	*MAT_173
*MAT_MOHR_NON_ASSOCIATED_FLOW	*MAT_260B
*MAT_MOMENT_CURVATURE_BEAM	*MAT_166
*MAT_MOONEY-RIVLIN_RUBBER	*MAT_027
*MAT_MOONEY-RIVLIN_PHASE_CHANGE	*MAT_218
*MAT_MTS	*MAT_088
*MAT_MUSCLE	*MAT_156
*MAT_NON_QUADRATIC_FAILURE	*MAT_258
*MAT_NONLINEAR_ELASTIC_DISCRETE_BEAM	*MAT_067

ALPHABETIZED MATERIALS LIST

Material Keyword	Number
*MAT_NONLINEAR_ORTHOTROPIC	*MAT_040
*MAT_NONLINEAR_PLASTIC_DISCRETE_BEAM	*MAT_068
*MAT_NONLOCAL	
*MAT_NULL	*MAT_009
*MAT_OGDEN_RUBBER	*MAT_077_O
*MAT_OPTIONTROPIC_ELASTIC	*MAT_002
*MAT_ORIENTED_CRACK	*MAT_017
*MAT_ORTHO_ELASTIC_PLASTIC	*MAT_108
*MAT_ORTHOTROPIC_ELASTIC_PHASE_CHANGE	*MAT_217
*MAT_ORTHOTROPIC_SIMPLIFIED_DAMAGE	*MAT_221
*MAT_ORTHOTROPIC_SMEARED_CRACK	*MAT_132
*MAT_ORTHOTROPIC_THERMAL	*MAT_021
*MAT_ORTHOTROPIC_VISCOELASTIC	*MAT_086
*MAT_PAPER	*MAT_274
*MAT_PERT_PIECEWISE_LINEAR_PLASTICITY	*MAT_238
*MAT_PHS_BMW	*MAT_248
*MAT_PIECEWISE_LINEAR_PLASTIC_THERMAL	*MAT_255
*MAT_PIECEWISE_LINEAR_PLASTICITY	*MAT_024
*MAT_PITZER_CRUSHABL_EFOAM	*MAT_144
*MAT_PLASTIC_GREEN-NAGHDI_RATE	*MAT_035
*MAT_PLASTIC_KINEMATIC	*MAT_003
*MAT_PLASTIC_NONLINEAR_KINEMATIC	*MAT_165
*MAT_PLASTICITY_COMPRESSION_TENSION	*MAT_124
*MAT_PLASTICITY_COMPRESSION_TENSION_EOS	*MAT_155
*MAT_PLASTICITY_POLYMER	*MAT_089
*MAT_PLASTICITY_WITH_DAMAGE	*MAT_081
*MAT_PLASTICITY_WITH_DAMAGE_ORTHO(_RCDC)	*MAT_082(_RCDC)
*MAT_PML_{OPTION}TROPIC_ELASTIC	*MAT_245
*MAT_PML_ACOUSTIC	*MAT_231
*MAT_PML_ELASTIC	*MAT_230

ALPHABETIZED MATERIALS LIST

Material Keyword	Number
*MAT_PML_ELASTIC_FLUID	*MAT_230
*MAT_PML_HYSTERETIC	*MAT_237
*MAT_PML_NULL	*MAT_246
*MAT_POLYMER	*MAT_168
*MAT_POWDER	*MAT_271
*MAT_POWER_LAW_PLASTICITY	*MAT_018
*MAT_PSEUDO_TENSOR	*MAT_016
*MAT_QUASILINEAR_VISCOELASTIC	*MAT_176
*MAT_RAMBERG-OSGOOD	*MAT_080
*MAT_RATE_SENSITIVE_COMPOSITE_FABRIC	*MAT_158
*MAT_RATE_SENSITIVE_POLYMER	*MAT_141
*MAT_RATE_SENSITIVE_POWERLAW_PLASTICITY	*MAT_064
*MAT_RC_BEAM	*MAT_174
*MAT_RC_SHEAR_WALL	*MAT_194
*MAT_REINFORCED_THERMOPLASTIC	*MAT_249
*MAT_REINFORCED_THERMOPLASTIC_UDFIBER	*MAT_249_UDFIBER
*MAT_RESULTANT_ANISOTROPIC	*MAT_170
*MAT_RESULTANT_PLASTICITY	*MAT_028
*MAT_RHT	*MAT_272
*MAT_RIGID	*MAT_020
*MAT_RIGID_DISCRETE	*MAT_220
*MAT_SAMP-1	*MAT_187
*MAT_SAMP_LIGHT	*MAT_187L
*MAT_SCC_ON_RCC	*MAT_236
*MAT_SCHWER_MURRAY_CAP_MODEL	*MAT_145
*MAT_SEATBELT	*MAT_B01
*MAT_SEISMIC_BEAM	*MAT_191
*MAT_SEISMIC_ISOLATOR	*MAT_197
*MAT_SHAPE_MEMORY	*MAT_030
*MAT_SHAPE_MEMORY_ALLOY	*MAT_291

ALPHABETIZED MATERIALS LIST

Material Keyword	Number
*MAT_SID_DAMPER_DISCRETE_BEAM	*MAT_069
*MAT_SIMPLIFIED_JOHNSON_COOK	*MAT_098
*MAT_SIMPLIFIED_JOHNSON_COOK_ORTHOTROPIC_DAMAGE	*MAT_099
*MAT_SIMPLIFIED_RUBBER/FOAM_{OPTION}	*MAT_181
*MAT_SIMPLIFIED_RUBBER_WITH_DAMAGE	*MAT_183
*MAT_SMOOTH_VISCOELASTIC_VISCOPLASTIC	*MAT_275
*MAT_SOFT_TISSUE	*MAT_091
*MAT_SOFT_TISSUE_VISCO	*MAT_092
*MAT_SOIL_AND_FOAM	*MAT_005
*MAT_SOIL_AND_FOAM_FAILURE	*MAT_014
*MAT_SOIL_BRICK	*MAT_192
*MAT_SOIL_CONCRETE	*MAT_078
*MAT_SOIL_SANISAND	*MAT_207
*MAT_SPECIAL_ORTHOTROPIC	*MAT_130
*MAT_SPH_INCOMPRESSIBLE_FLUID	*MAT_SPH_02
*MAT_SPH_INCOMPRESSIBLE_STRUCTURE	*MAT_SPH_03
*MAT_SPH_VISCOUS	*MAT_SPH_01
*MAT_SPOTWELD_{OPTION}	*MAT_100
*MAT_SPOTWELD_DAIMLERCHRYSLER	*MAT_100_DA
*MAT_SPR_JLR	*MAT_211
*MAT_SPRING_ELASTIC	*MAT_S01
*MAT_SPRING_ELASTOPLASTIC	*MAT_S03
*MAT_SPRING_GENERAL_NONLINEAR	*MAT_S06
*MAT_SPRING_INELASTIC	*MAT_S08
*MAT_SPRING_MAXWELL	*MAT_S07
*MAT_SPRING_MUSCLE	*MAT_S15
*MAT_SPRING_NONLINEAR_ELASTIC	*MAT_S04
*MAT_SPRING_SQUAT_SHEARWALL	*MAT_S14
*MAT_SPRING_TRILINEAR_DEGRADING	*MAT_S13
*MAT_STEEL_CONCENTRIC_BRACE	*MAT_171

ALPHABETIZED MATERIALS LIST

Material Keyword	Number
*MAT_STEEL_EC3	*MAT_202
*MAT_STEINBERG	*MAT_011
*MAT_STEINBERG_LUND	*MAT_011_LUND
*MAT_STOUGHTON_NON_ASSOCIATED_FLOW	*MAT_260A
*MAT_STRAIN_RATE_DEPENDENT_PLASTICITY	*MAT_019
*MAT_TABULATED_JOHNSON_COOK	*MAT_224
*MAT_TABULATED_JOHNSON_COOK_GYS	*MAT_224_GYS
*MAT_TABULATED_JOHNSON_COOK_ORTHO_PLASTICITY	*MAT_264
*MAT_TAILORED_PROPERTIES	*MAT_251
*MAT_TEMPERATURE_DEPENDENT_ORTHOTROPIC	*MAT_023
*MAT_THERMAL_CHEMICAL_REACTION	*MAT_T06
*MAT_THERMAL_CHEMICAL_REACTION_ORTHOTROPIC	*MAT_T17
*MAT_THERMAL_CWM	*MAT_T07
*MAT_THERMAL_DISCRETE_BEAM	*MAT_T05
*MAT_THERMAL_ISOTROPIC	*MAT_TO1
*MAT_THERMAL_ISOTROPIC_PHASE_CHANGE	*MAT_T09
*MAT_THERMAL_ISOTROPIC_TD	*MAT_T03
*MAT_THERMAL_ISOTROPIC_TD_LC	*MAT_T10
*MAT_THERMAL_OPTION	*MAT_T00
*MAT_THERMAL_ORTHOTROPIC	*MAT_T02
*MAT_THERMAL_ORTHOTROPIC_TD	*MAT_T04
*MAT_THERMAL_ORTHOTROPIC_TD_LC	*MAT_T08
*MAT_THERMAL_USER_DEFINED	*MAT_T11
*MAT_THERMO_ELASTO_VISCOPLASTIC_CREEP	*MAT_188
*MAT_TISSUE_DISPERSSED	*MAT_266
*MAT_TNM_POLYMER	*MAT_318
*MAT_TOUGHENED_ADHESIVE_POLYMER	*MAT_252
*MAT_TRANSVERSELY_ANISOTROPIC_ELASTIC_PLASTIC	*MAT_037
*MAT_TRANSVERSELY_ISOTROPIC_CRUSHABLE_FOAM	*MAT_142
*MAT_TRIP	*MAT_113

ALPHABETIZED MATERIALS LIST

Material Keyword	Number
*MAT_UHS_STEEL	*MAT_244
*MAT_UNIFIED_CREEP	*MAT_115
*MAT_UNIFIED_CREEP_ORTHO	*MAT_115_O
*MAT_USER_DEFINED_MATERIAL_MODELS	*MAT_041-050
*MAT_VACUUM	*MAT_140
*MAT_VEGTER	*MAT_136
*MAT_VEGTER_STANDARD	*MAT_136_STD
*MAT_VEGTER_2017	*MAT_136_2017
*MAT_VISCOELASTIC	*MAT_006
*MAT_VISCOELASTIC_FABRIC	*MAT_134
*MAT_VISCOELASTIC_HILL_FOAM	*MAT_178
*MAT_VISCOELASTIC_LOOSE_FABRIC	*MAT_234
*MAT_VISCOELASTIC_THERMAL	*MAT_175
*MAT_VISCOPLASTIC_MIXED_HARDENING	*MAT_225
*MAT_VISCOUS_FOAM	*MAT_062
*MAT_WINFRITH_CONCRETE_REINFORCEMENT	*MAT_084_REINF
*MAT_WINFRITH_CONCRETE	*MAT_084
*MAT_WOOD_{OPTION}	*MAT_143
*MAT_WTM_STM	*MAT_135
*MAT_WTM_STM_PLC	*MAT_135_PLC

***MAT_ADD_AIRBAG_POROSITY_LEAKAGE**

This command allows users to model porosity leakage through non-fabric material when such material is used as part of control volume, airbag. It applies to both *AIRBAG_HYBRID and *AIRBAG_WANG_NEFSKE.

Card Summary:

Card 1a. This card is included if and only if $0 < X0 < 1$.

MID	X2	X3	ELA	FVOPT	X0	X1	
-----	----	----	-----	-------	----	----	--

Card 1b. This card is included if $X0 = 0$ and $FVOPT < 7$.

MID	FLC	FAC	ELA	FVOPT	X0	X1	
-----	-----	-----	-----	-------	----	----	--

Card 1c. This card is included if $X0 = 0$ and $FVOPT \geq 7$.

MID	FLC	FAC	ELA	FVOPT	X0	X1	
-----	-----	-----	-----	-------	----	----	--

Card 1d. This card is included if $X0 = 1$ and $FVOPT < 7$.

MID	FLC	FAC	ELA	FVOPT	X0	X1	
-----	-----	-----	-----	-------	----	----	--

Card 1e. This card is included if $X0 = 1$ and $FVOPT \geq 7$.

MID	FLC	FAC	ELA	FVOPT	X0	X1	
-----	-----	-----	-----	-------	----	----	--

Data Card Definitions:

This card is included if and only if $0 < X0 < 1$.

Card 1a	1	2	3	4	5	6	7	8
Variable	MID	X2	X3	ELA	FVOPT	X0	X1	
Type	A	F	F	F	F	F	F	
Default	none	none	1.0	none	none	none	none	

VARIABLE**DESCRIPTION**

MID

Material ID for which the porosity leakage property applies

VARIABLE	DESCRIPTION
X2	X2 is one of the coefficients of the porosity in the equation of Anagonye and Wang [1999]. (Defined below in description for X0/X1)
X3	X3 is one of the coefficients of the porosity in the equation of Anagonye and Wang [1999]. (Defined below in description for X0/X1)
ELA	<p>Effective leakage area for blocked fabric, ELA</p> <p>LT.0.0: ELA is the load curve ID of the curve defining ELA as a function of time. The default value of zero assumes that no leakage occurs. A value of .10 would assume that 10% of the blocked fabric is leaking gas.</p>
FVOPT	<p>Fabric venting option.</p> <p>EQ.1: Wang-Nefske formulas for venting through an orifice are used. Blockage is not considered.</p> <p>EQ.2: Wang-Nefske formulas for venting through an orifice are used. Blockage of venting area due to contact is considered.</p> <p>EQ.3: Leakage formulas of Graefe, Krummheuer, and Siejak [1990] are used. Blockage is not considered.</p> <p>EQ.4: Leakage formulas of Graefe, Krummheuer, and Siejak [1990] are used. Blockage of venting area due to contact is considered.</p> <p>EQ.5: Leakage formulas based on flow through a porous media are used. Blockage is not considered.</p> <p>EQ.6: Leakage formulas based on flow through a porous media are used. Blockage of venting area due to contact is considered.</p> <p>EQ.7: Leakage is based on gas volume outflow as a function of pressure load curve [Lian, 2000]. Blockage is not considered. Absolute pressure is used in the porous-velocity-versus-pressure load curve, given as FAC.</p> <p>EQ.8: Leakage is based on gas volume outflow as a function of pressure load curve [Lian 2000]. Blockage of venting or porous area due to contact is considered. Absolute pressure is used in the porous-velocity-versus-pressure load curve, given as FAC.</p>

VARIABLE	DESCRIPTION
X0, X1	Coefficients of Anagonye and Wang [1999] porosity equation for the leakage area: $A_{\text{leak}} = A_0(X_0 + X_1r_s + X_2r_p + X_3r_s r_p)$

This card is included if X0 = 0 and FVOPT < 7.

Card 1b	1	2	3	4	5	6	7	8
Variable	MID	FLC	FAC	ELA	FVOPT	X0	X1	
Type	A	F	F	F	F	F	F	
Default	none	opt	1.0	none	none	none	none	

VARIABLE	DESCRIPTION
MID	Material ID for which the porosity leakage property applies
FLC	Optional fabric porous leakage flow coefficient: GE.0.0: fabric porous leakage flow coefficient LT.0.0: FLC is the load curve ID of the curve defining FLC as a function of time.
FAC	Optional fabric characteristic parameter: GE.0.0: optional fabric characteristic parameter LT.0.0: FAC is the load curve ID of the curve defining FAC as a function of absolute pressure.
ELA	Effective leakage area for blocked fabric, ELA. LT.0.0: ELA is the load curve ID of the curve defining ELA as a function of time. The default value of zero assumes that no leakage occurs. A value of .10 would assume that 10% of the blocked fabric is leaking gas.
FVOPT	Fabric venting option. EQ.1: Wang-Nefske formulas for venting through an orifice are used. Blockage is not considered.

VARIABLE	DESCRIPTION
----------	-------------

EQ.2: Wang-Nefske formulas for venting through an orifice are used. Blockage of venting area due to contact is considered.

EQ.3: Leakage formulas of Graefe, Krummheuer, and Siejak [1990] are used. Blockage is not considered.

EQ.4: Leakage formulas of Graefe, Krummheuer, and Siejak [1990] are used. Blockage of venting area due to contact is considered.

EQ.5: Leakage formulas based on flow through a porous media are used. Blockage is not considered.

EQ.6: Leakage formulas based on flow through a porous media are used. Blockage of venting area due to contact is considered.

X0, X1 Coefficients of Anagonye and Wang [1999] porosity equation for the leakage area:

$$A_{\text{leak}} = A_0(X_0 + X_1r_s + X_2r_p + X_3r_s r_p)$$

This card is included if X0 = 0 and FVOPT ≥ 7.

Card 1c	1	2	3	4	5	6	7	8
Variable	MID	FLC	FAC	ELA	FVOPT	X0	X1	
Type	A	F	F	F	F	F	F	
Default	none	opt	1.0	none	none	none	none	

VARIABLE	DESCRIPTION
----------	-------------

MID Material ID for which the porosity leakage property applies

FLC Optional fabric porous leakage flow coefficient:
 GE.0.0: fabric porous leakage flow coefficient
 LT.0.0: |FLC| is the load curve ID of the curve defining FLC as a function of time.

FAC Optional fabric characteristic parameter:

VARIABLE	DESCRIPTION
----------	-------------

GE.0.0: optional fabric characteristic parameter

LT.0.0: FAC defines leakage volume flux rate as a function of absolute pressure. The volume flux (per area) rate (per time) has the unit of velocity and it is equivalent to relative porous gas speed.

$$\left[\frac{d(\text{Vol}_{\text{flux}})}{dt} \right] = \frac{[\text{volume}]}{[\text{area}]} \frac{1}{[\text{time}]} = \frac{[\text{length}]}{[\text{time}]} = [\text{velocity}]$$

ELA Effective leakage area for blocked fabric, ELA.

LT.0.0: |ELA| is the load curve ID of the curve defining ELA as a function of time. The default value of zero assumes that no leakage occurs. A value of .10 would assume that 10% of the blocked fabric is leaking gas.

FVOPT Fabric venting option.

EQ.7: Leakage is based on gas volume outflow as a function of pressure load curve [Lian, 2000]. Blockage is not considered. Absolute pressure is used in the porous-velocity-versus-pressure load curve, given as FAC.

EQ.8: Leakage is based on gas volume outflow as a function of pressure load curve [Lian 2000]. Blockage of venting or porous area due to contact is considered. Absolute pressure is used in the porous-velocity-versus-pressure load curve, given as FAC.

X0, X1 Coefficients of Anagonye and Wang [1999] porosity equation for the leakage area:

$$A_{\text{leak}} = A_0(X_0 + X_1r_s + X_2r_p + X_3r_s r_p)$$

This card is included if X0 = 1 and FVOPT < 7.

Card 1d	1	2	3	4	5	6	7	8
Variable	MID	FLC	FAC	ELA	FVOPT	X0	X1	
Type	A	F	F	F	F	F	F	
Default	none	opt	1.0	none	none	none	none	

VARIABLE	DESCRIPTION
MID	Material ID for which the porosity leakage property applies
FLC	<p>Optional fabric porous leakage flow coefficient:</p> <p>GE.0.0: fabric porous leakage flow coefficient</p> <p>LT.0.0: FLC is the load curve ID defining FLC as a function of the stretching ratio defined as $r_s = A/A_0$.</p>
FAC	<p>Optional fabric characteristic parameter:</p> <p>GE.0.0: optional fabric characteristic parameter</p> <p>LT.0.0: FAC is the load curve ID defining FAC as a function of the pressure ratio defined as $r_p = P_{\text{air}}/P_{\text{bag}}$. See Remark 2 of *MAT_FABRIC.</p>
ELA	<p>Effective leakage area for blocked fabric, ELA.</p> <p>LT.0.0: ELA is the load curve ID of the curve defining ELA as a function of time. The default value of zero assumes that no leakage occurs. A value of .10 would assume that 10% of the blocked fabric is leaking gas.</p>
FVOPT	<p>Fabric venting option.</p> <p>EQ.1: Wang-Nefske formulas for venting through an orifice are used. Blockage is not considered.</p> <p>EQ.2: Wang-Nefske formulas for venting through an orifice are used. Blockage of venting area due to contact is considered.</p> <p>EQ.3: Leakage formulas of Graefe, Krummheuer, and Siejak [1990] are used. Blockage is not considered.</p> <p>EQ.4: Leakage formulas of Graefe, Krummheuer, and Siejak [1990] are used. Blockage of venting area due to contact is considered.</p> <p>EQ.5: Leakage formulas based on flow through a porous media are used. Blockage is not considered.</p> <p>EQ.6: Leakage formulas based on flow through a porous media are used. Blockage of venting area due to contact is considered.</p>

VARIABLE**DESCRIPTION**

X0, X1

Coefficients of Anagonye and Wang [1999] porosity equation for the leakage area:

$$A_{\text{leak}} = A_0(X_0 + X_1r_s + X_2r_p + X_3r_s r_p)$$

This card is included if X0 = 1 and FVOPT ≥ 7.

Card 1e	1	2	3	4	5	6	7	8
Variable	MID	FLC	FAC	ELA	FVOPT	X0	X1	
Type	A	F	F	F	F	F	F	
Default	none	opt	1.0	none	none	none	none	

VARIABLE**DESCRIPTION**

MID

Material ID for which the porosity leakage property applies

FLC

Optional fabric characteristic parameter:

GE.0.0: optional fabric characteristic parameter

LT.0.0: |FAC| is the the load curve ID defining FLC as a function of the stretching ratio defined as $r_s = A/A_0$.

FAC

Optional fabric characteristic parameter:

GE.0.0: optional fabric characteristic parameter

LT.0.0: FAC defines leakage volume flux rate as a function of absolute pressure. The volume flux (per area) rate (per time) has the unit of velocity and it is equivalent to relative porous gas speed.

$$\left[\frac{d(\text{Vol}_{\text{flux}})}{dt} \right] = \frac{[\text{volume}]}{[\text{area}]} \frac{1}{[\text{time}]} = \frac{[\text{length}]}{[\text{time}]} = [\text{velocity}]$$

ELA

Effective leakage area for blocked fabric, ELA.

LT.0.0: |ELA| is the load curve ID of the curve defining ELA versus time. The default value of zero assumes that no leakage occurs. A value of .10 would assume that 10% of the blocked fabric is leaking gas.

VARIABLE	DESCRIPTION
FVOPT	<p>Fabric venting option.</p> <p>EQ.7: Leakage is based on gas volume outflow as a function of pressure load curve [Lian, 2000]. Blockage is not considered. Absolute pressure is used in the porous-velocity-versus-pressure load curve, given as FAC.</p> <p>EQ.8: Leakage is based on gas volume outflow as a function of pressure load curve [Lian 2000]. Blockage of venting or porous area due to contact is considered. Absolute pressure is used in the porous-velocity-versus-pressure load curve, given as FAC.</p>
X0, X1	<p>Coefficients of Anagonye and Wang [1999] porosity equation for the leakage area:</p> $A_{\text{leak}} = A_0(X_0 + X_1r_s + X_2r_p + X_3r_s r_p)$

***MAT_ADD_CHEM_SHRINKAGE**

The ADD_CHEM_SHRINKAGE option allows for adding the chemical shrinkage effect to a material model.

Card 1	1	2	3	4	5	6	7	8
Variable	PID	LCID						
Type	I	I						
Default	none	none						

VARIABLE**DESCRIPTION**

PID

Part ID for which the chemical shrinkage effect applies

LCID

Load curve ID (see *DEFINE_CURVE) defining the chemical shrinkage coefficient, β , or a proxy in experiments for the chemical shrinkage coefficient, α , as a function of temperature, T . If α as a function of T is defined, α is converted to the chemical shrinkage coefficient by LS-DYNA (see [Remark 2](#)).

Remarks:

- Chemical Shrinkage Effect on Strain.** If the chemical shrinkage effect is included, the strain rate tensor, $\dot{\epsilon}$, is given by

$$\dot{\epsilon} = \dot{\epsilon}^e + \dot{\epsilon}^p + \dot{\epsilon}^c .$$

Here, $\dot{\epsilon}^e$ is the elastic strain rate tensor, $\dot{\epsilon}^p$ is the plastic strain rate tensor, and $\dot{\epsilon}^c$ is the chemical shrinkage strain rate tensor. $\dot{\epsilon}^c$ is given by

$$\dot{\epsilon}^c = \beta \dot{T} \mathbf{I} .$$

Here β is the chemical shrinkage coefficient and \dot{T} is the rate of temperature change.

- Chemical Shrinkage Coefficient.** The chemical shrinkage coefficient can be defined in two ways with LCID: either directly or through the proxy variable from experiments, α . If α is defined as the ordinate, LS-DYNA internally converts the ordinate of the load curve, LCID, to β :

$$\beta = (1 - \alpha)^3 - 1 .$$

Note that DATTYP on *DEFINE_CURVE *must be set to -100* if LCID defines α as a function of temperature.

- 3. Thermal Expansion with Shrinkage Effects.** If both thermal expansion and chemical shrinkage effects are modeled in one simulation, the thermal expansion should be defined with *MAT_THERMAL_ISOTROPIC_TITLE. The TITLE keyword option must be defined to distinguish between the thermal expansion and chemical shrinkage.

***MAT_ADD_COHESIVE**

The ADD_COHESIVE option offers the possibility to use a selection of three-dimensional material models in LS-DYNA in conjunction with cohesive elements. See [Remark 1](#).

Usually the cohesive elements (ELFORM = 19 and 20 of *SECTION_SOLID) can only be used with a small number of material models (41-50, 138, 184, 185, 186, 240). But with this additional keyword, a larger number of standard three-dimensional material models can be used that would only be available for solid elements in general. Currently the following material models are supported: 1, 3, 4, 6, 15, 24, 41-50, 57, 81, 82, 83, 89, 96, 98, 103, 104, 105, 106, 107, 115, 120, 123, 124, 141, 168, 173, 187, 188, 193, 224, 225, 251, 252, 255, 277, and 307.

Card 1	1	2	3	4	5	6	7	8
Variable	PID	ROFLG	INTFAIL	THICK	UNIAX			
Type	I	F	F	F	F			
Default	none	0.0	0.0	0.0	0.0			

VARIABLE**DESCRIPTION**

PID

Part ID for which the cohesive property applies.

ROFLG

Flag for whether density is specified per unit area or volume.

EQ.0.0: Density specified per unit volume (default).

EQ.1.0: Density specified per unit area for controlling the mass of cohesive elements with an initial volume of zero.

INTFAIL

The number of integration points required for the cohesive element to be deleted. The value of INTFAIL may range from 1 to 4 with 1 the recommended value.

LT.0.0: Employs a Newton-Cotes integration scheme. The element will be deleted when $|\text{INTFAIL}|$ integration points have failed.EQ.0.0: Employs a Newton-Cotes integration scheme. The element will *not* be deleted even if it satisfies the failure criterion.

VARIABLE	DESCRIPTION
	GT.0.0: Employs a Gauss integration scheme. The element will be deleted when INTFAIL integration points have failed.
THICK	Thickness of the adhesive layer (see Remark 3): EQ.0.0: The actual thickness of the cohesive element is used. GT.0.0: User specified thickness.
UNIAX	Flag for enforcing a uniaxial stress state (see Remark 2): EQ.0.0: No modification of the three-dimensional stress state (default). EQ.1.0: Stress components that are not used for the cohesive element are reset to 0.0 after each evaluation of the constitutive model.

Remarks:

- Three-Dimensional Constitutive Laws with Cohesive Elements.** Cohesive elements possess 3 kinematic variables, namely, two relative displacements δ_1 , δ_2 in tangential directions and one relative displacement δ_3 in normal direction. In a corresponding constitutive model, they are used to compute 3 associated traction stresses t_1 , t_2 , and t_3 . For example, in the elastic case (*MAT_COHESIVE_ELASTIC):

$$\begin{bmatrix} t_1 \\ t_2 \\ t_3 \end{bmatrix} = \begin{bmatrix} E_T & 0 & 0 \\ 0 & E_T & 0 \\ 0 & 0 & E_N \end{bmatrix} \begin{bmatrix} \delta_1 \\ \delta_2 \\ \delta_3 \end{bmatrix}.$$

Hypoelastic three-dimensional material models for standard solid elements, however, are formulated with respect to 6 independent strain rates and 6 associated stress rates. For isotropic elasticity (*MAT_ELASTIC):

$$\begin{bmatrix} \dot{\sigma}_{xx} \\ \dot{\sigma}_{yy} \\ \dot{\sigma}_{zz} \\ \dot{\sigma}_{xy} \\ \dot{\sigma}_{yz} \\ \dot{\sigma}_{zx} \end{bmatrix} = \frac{E}{(1+\nu)(1-2\nu)} \begin{bmatrix} 1-\nu & \nu & \nu & 0 & 0 & 0 \\ \nu & 1-\nu & \nu & 0 & 0 & 0 \\ \nu & \nu & 1-\nu & 0 & 0 & 0 \\ 0 & 0 & 0 & 1-2\nu & 0 & 0 \\ 0 & 0 & 0 & 0 & 1-2\nu & 0 \\ 0 & 0 & 0 & 0 & 0 & 1-2\nu \end{bmatrix} \begin{bmatrix} \dot{\epsilon}_{xx} \\ \dot{\epsilon}_{yy} \\ \dot{\epsilon}_{zz} \\ \dot{\epsilon}_{xy} \\ \dot{\epsilon}_{yz} \\ \dot{\epsilon}_{zx} \end{bmatrix}.$$

To be able to use such three-dimensional material models in a cohesive element environment, an assumption is necessary to transform 3 relative displacements to 6 strain rates. Therefore, we assume that neither lateral expansion nor in-plane shearing is possible. Thus,

$$\begin{bmatrix} \delta_1 \\ \delta_2 \\ \delta_3 \end{bmatrix} \rightarrow \begin{bmatrix} \dot{\epsilon}_{xx} \\ \dot{\epsilon}_{yy} \\ \dot{\epsilon}_{zz} \\ \dot{\epsilon}_{xy} \\ \dot{\epsilon}_{yz} \\ \dot{\epsilon}_{zx} \end{bmatrix} = \begin{bmatrix} 0 \\ 0 \\ \dot{\delta}_3/(t + \delta_3) \\ 0 \\ \dot{\delta}_2/(t + \delta_3) \\ \dot{\delta}_1/(t + \delta_3) \end{bmatrix},$$

where t is the initial thickness of the adhesive layer; see parameter THICK. These strain rates are then used in a three-dimensional constitutive model to obtain new Cauchy stresses, where 3 components can finally be used for the cohesive element:

$$\begin{bmatrix} \sigma_{xx} \\ \sigma_{yy} \\ \sigma_{zz} \\ \sigma_{xy} \\ \sigma_{yz} \\ \sigma_{zx} \end{bmatrix} \rightarrow \begin{bmatrix} t_1 \\ t_2 \\ t_3 \end{bmatrix} = \begin{bmatrix} \sigma_{zx} \\ \sigma_{yz} \\ \sigma_{zz} \end{bmatrix}.$$

For hyperelastic material models 57 and 83, the deformation gradient is obtained by an incremental update of the strain rates mentioned above.

2. **Forcing Uniaxial Stress State.** As stated in [Remark 1](#), only three values from the six stress components are used for the cohesive element. By default, the remaining stress components are not modified. Consequently, transverse normal stresses, σ_{xx} and σ_{yy} , and in-plane shear stress, σ_{xy} , will in most cases build-up during the simulation of uniaxial loading of the cohesive zone due to Poisson's effect and the given reduced strain rate tensor. These stress components should not affect the response of the cohesive element for elastic or viscoelastic material models. They will, however, have a significant effect for most materials with plasticity. If undesired, the effect can be reduced by setting the UNIAX flag which resets the unused stress components σ_{xx} , σ_{yy} and σ_{xy} to 0.0 after each evaluation of the three-dimensional constitutive model.
3. **Critical Time Step.** The critical time step size for cohesive elements depends on nodal masses (that is, element volume and density) and the stiffness of the material, $\max(E_T, E_N)$. Note that stiffness has units of stress per length³, such as N/mm³. With *MAT_ADD_COHESIVE, the elastic moduli (stress unit) from the corresponding 3-dimensional material model are taken and related to the thickness (length unit) of the cohesive element. Thus, the thickness of the cohesive element (either coming from geometry or THICK) changes the critical time step size. Therefore, we recommend using a reasonable value for THICK.
4. **Output to d3plot.** If this keyword is used with a three-dimensional material model, the output to d3plot or elout is organized as with other material models for cohesive elements; see for example *MAT_184. Instead of the usual six stress components, three traction stresses are written into those databases. The in-

plane shear traction along the 1-2 edge replaces the x component of stress, the orthogonal in-plane shear traction replaces the y component of stress, and the traction in the normal direction replaces the z component of stress.

***MAT_ADD_DAMAGE_DIEM**

Many of the constitutive models in LS-DYNA do not allow failure and erosion. The ADD_DAMAGE_DIEM option provides a way of including damage and failure in these models. DIEM comprises various “damage initiation and evolution models.” See remarks for details.

This keyword originates from a split out of *MAT_ADD_EROSION, where only “sudden” failure criteria without damage remain. It applies to nonlinear element formulations including 2D continuum elements, beam element formulation 1, 3D shell elements (including isogeometric shells), 3D solid elements (including isogeometric solids) and thick shells.

NOTE: All *MAT_ADD_DAMAGE_DIEM commands in a model can be disabled by using *CONTROL_MAT.

Card 1	1	2	3	4	5	6	7	8
Variable	MID	NDIEMC	DINIT	DEPS	NUMFIP			
Type	A	F	F	F	F			
Default	none	0.0	0.0	0.0	1.0			

Data Card Pairs. Include NDIEMC pairs of Cards 2 and 3.

Card 2	1	2	3	4	5	6	7	8
Variable	DITYP	P1	P2	P3	P4	P5		
Type	F	F	F	F	F	F		
Default	0.0	0.0	0.0	0.0	0.0	0.0		

Card 3	1	2	3	4	5	6	7	8
Variable	DETYP	DCTYP	Q1	Q2	Q3	Q4		
Type	F	F	F	F	F	F		
Default	0.0	0.0	0.0	0.0	0.0	0.0		

VARIABLE**DESCRIPTION**

MID	Material identification for which this erosion definition applies. A unique number or label must be specified (see *PART).
NDIEMC	Number of damage initiation and evolution model (DIEM) criteria to be applied, at most 5 is allowed.
DINIT	Damage initialization option: EQ.0: No action is taken. EQ.1: Damage history is initiated based on values of the initial plastic strains and the initial strain tensor. This is to be used in multistage analyses.
DEPS	Plastic strain increment between evaluation of damage instability and evolution criteria. See Remark 1 . The default is zero.
NUMFIP	Number or percentage of failed integration points prior to element deletion (default value is 1): GT.0.0: Number of integration points which must fail before element is deleted. LT.0.0: Applies only to shells. NUMFIP is the percentage of layers which must fail before an element fails. For shell formulations with 4 integration points per layer, the layer is considered failed if any of the integration points in the layer fails.
DITYP	Damage initiation type (see Damage Initiation section): EQ.0.0: Ductile based on stress triaxiality EQ.1.0: Shear EQ.2.0: MSFLD

VARIABLE	DESCRIPTION
	EQ.3.0: FLD
	EQ.4.0: Ductile based on normalized principal stress
P1	<p>Damage initiation parameter:</p> <p>DITYP.EQ.0.0: Load curve/table ID representing plastic strain at the onset of damage as a function of stress triaxiality (η) and optionally plastic strain rate, represented by ϵ_D^p in the theory below. If the first strain rate value in the table is negative, it is assumed to be given with respect to logarithmic strain rate.</p> <p>DITYP.EQ.1.0: Load curve/table ID representing plastic strain at onset of damage as a function of shear influence (θ) and optionally plastic strain rate, represented by ϵ_D^p in the theory below. If the first strain rate value in the table is negative, it is assumed to be given with respect to logarithmic strain rate.</p> <p>DITYP.EQ.2.0: Load curve/table ID representing plastic strain at onset of damage as a function of ratio of principal plastic strain rates (α) and optionally plastic strain rate, represented by ϵ_D^p in the theory below. If the first strain rate value in the table is negative, it is assumed to be given with respect to logarithmic strain rate.</p> <p>DITYP.EQ.3.0: Load curve/table ID representing plastic strain at onset of damage as a function of ratio of principal plastic strain rates (α) and optionally plastic strain rate, represented by ϵ_D^p in the theory below. If the first strain rate value in the table is negative, it is assumed to be given with respect to logarithmic strain rate.</p> <p>DITYP.EQ.4.0: Load curve/table ID representing plastic strain at onset of damage as a function of stress state parameter (β) and optionally plastic strain rate, represented by ϵ_D^p in the theory below. If the first strain rate value in the table is negative, it is assumed to be given with respect to logarithmic strain rate.</p>

VARIABLE	DESCRIPTION
P2	Damage initiation parameter: DITYP.EQ.0.0: Not used DITYP.EQ.1.0: Pressure influence parameter, k_s DITYP.EQ.2.0: Layer specification: EQ.0: Mid layer EQ.1: Outer layer DITYP.EQ.3.0: Layer specification: EQ.0: Mid layer EQ.1: Outer layer DITYP.EQ.4.0: Triaxiality influence parameter, k_d
P3	Damage initiation parameter: DITYP.EQ.0.0: Not used DITYP.EQ.1.0: Computation of maximum shear stress for shells: EQ.0: 3-dimensional EQ.1: 2-dimensional DITYP.EQ.2.0: Initiation formulation: EQ.0: Direct EQ.1: Incremental DITYP.EQ.3.0: Initiation formulation: EQ.0: Direct EQ.1: Incremental DITYP.EQ.4.0: Not used
P4	Plane stress option for shell elements: EQ.0.0: Transverse shear stresses, σ_{yz} and σ_{zx} , are included in the computation of stress invariants, such as the triaxiality. EQ.1.0: Transverse shear stresses, σ_{yz} and σ_{zx} , are <i>not</i> included in the computation of stress invariants, such as the triaxiality. Useful in combination with “plane stress” material models, where the transverse shear stresses are also excluded from the yield condition, such as *MAT_024_2D or *MAT_036.

VARIABLE	DESCRIPTION
P5	Load curve or table ID representing regularization factor as a function of the characteristic element size (curve) or regularization factor as a function of the characteristic element size and abscissa value of the criterion used (table). The criterion is the curve/table specified in P1. For example, for DITYP = 0.0, the regularization factor would depend on stress triaxiality. This factor scales the plastic strain at the onset of damage defined with P1.
DETYP	Damage evolution type: EQ.0.0: Linear softening. Evolution of damage is a function of the plastic displacement after the initiation of damage. EQ.1.0: Linear softening, Evolution of damage is a function of the fracture energy after the initiation of damage.
DCTYP	Damage composition option for multiple criteria: EQ.-1.0: Damage not coupled to stress EQ.0.0: Maximum EQ.1.0: Multiplicative
Q1	Damage evolution parameter: DETYP.EQ.0.0: Plastic displacement at failure, u_f^p . A negative value corresponds to a <i>table</i> ID for u_f^p as a function of triaxiality and damage. DETYP.EQ.1.0: Fracture energy at failure, G_f
Q2	Set to 1.0 to output information to log files (messag and d3hsp) when an integration point fails.
Q3	Damage evolution parameter: DETYP.EQ.0.0: Exponent, α , in nonlinear damage evolution law, activated when $u_f^p > 0$ and $\alpha > 0$. DETYP.EQ.1.0: Not used.

VARIABLE	DESCRIPTION
Q4	Load curve or table ID representing regularization factor as a function of the characteristic element size (curve) or regularization factor as a function of the characteristic element size and abscissa value of the criterion used (table). The criterion is the curve/table specified in P1. For example, for DITYP = 0.0, the regularization factor would depend on stress triaxiality. If Q4 is input with a negative sign, the second table input should be plastic strain rate instead of the abscissa value. This factor scales the damage evolution parameter Q1.

Remarks:

1. **DEPS.** In DIEM, you may invoke up to 5 damage initiation and evolution criteria. For the sake of efficiency, the parameter DEPS can be used to only check these criteria in quantified increments of plastic strain. In other words, the criteria are only checked when the effective plastic strain goes beyond DEPS, $2 \times \text{DEPS}$, $3 \times \text{DEPS}$, etc. For $\text{DEPS} = 0$ the checks are performed in each step there is plastic flow. A reasonable value of DEPS could, for instance, be $\text{DEPS} = 0.0001$.
2. **Damage Initiation and Evolution Variables.** Assume that n initiation/evolution types have been specified in the input deck ($n = \text{NDIEMC}$). At each integration point a damage initiation variable, ω_D^i , and an evolution history variable D^i exist, such that,

$$\omega_D^i \in [0, \infty)$$

and

$$D^i \in [0,1] , \quad i = 1, \dots, n .$$

These are initially set to zero and evolve with the deformation of the elements according to rules associated with the specific damage initiation and evolution type chosen, see below for details.

These quantities can be post-processed as ordinary material history variables and their positions in the history variables array is given in d3hsp, search for the string *Damage history listing*. The damage initiation variables do not influence the results but serve to indicate the onset of damage. As an alternative, the keyword *DEFINE_MATERIAL_HISTORIES can be used to output the instability and damage, following

<i>*DEFINE_MATERIAL_HISTORIES Properties</i>		
Label	Attributes	Description
Instability	- - - -	Maximum initiation variable, $\max_{i=1,\dots,n} \omega_D^i$
Damage	- - - -	Effective damage D , see below

The damage evolution variables govern the damage in the material and are used to form the global damage $D \in [0,1]$. Each criterion is of either of DCTYP set to maximum (DCTYP = 0) or multiplicative (DCTYP = 1), or one could choose to not couple damage to the stress by setting DCTYP = -1. This means that the damage value is calculated and stored, but it is not affecting the stress as for the other options, so if all DCTYP are set to -1 there will be no damage or failure. Letting I_{\max} denote the set of evolution types with DCTYP set to maximum and I_{mult} denote the set of evolution types with DCTYP set to multiplicative the global damage, D , is defined as

$$D = \max(D_{\max}, D_{\text{mult}}) ,$$

where

$$D_{\max} = \max_{i \in I_{\max}} D^i ,$$

and

$$D_{\text{mult}} = 1 - \prod_{i \in I_{\text{mult}}} (1 - D^i) .$$

The damage variable relates the macroscopic (damaged) to microscopic (true) stress by

$$\sigma = (1 - D)\tilde{\sigma} .$$

Once the damage has reached the level of D_{erode} (=0.99 by default) the stress is set to zero and the integration point is assumed failed and not processed thereafter. For NUMFIP > 0, a shell element is eroded and removed from the finite element model when NUMFIP integration points have failed. For NUMFIP < 0, a shell element is eroded and removed from the finite element model when -NUMFIP percent of the layers have failed.

Damage Initiation, ω_D :

For each evolution type i , ω_D^i governs the onset of damage. For $i \neq j$, the evolution of ω_D^i is independent from the evolution of ω_D^j . The following list enumerates the algorithms for modelling damage initiation.

In this subsection we suppress the superscripted i indexing the evolution type.

1. **Ductility Based on Stress Triaxiality (DITYP = 0).** For the ductile initiation option, a function $\varepsilon_D^p = \varepsilon_D^p(\eta, \dot{\varepsilon}^p)$ represents the plastic strain at onset of damage (P1). This is a function of stress triaxiality defined as

$$\eta = -\frac{p}{q},$$

with p being the pressure and q the von Mises equivalent stress. Optionally this can be defined as a table with the second dependency being on the effective plastic strain rate $\dot{\varepsilon}^p$, where a negative sign of the first strain rate in the table means that it is in logarithmic scale. The damage initiation history variable evolves according to

$$\omega_D = \int_0^{\varepsilon^p} \frac{d\varepsilon^p}{\varepsilon_D^p}.$$

2. **Shear (DITYP = 1).** For the shear initiation option, a function $\varepsilon_D^p = \varepsilon_D^p(\theta, \dot{\varepsilon}^p)$ represents the plastic strain at onset of damage (P1). This is a function of a shear stress function defined as

$$\theta = \frac{q + k_s p}{\tau}.$$

Here p is the pressure, q is the von Mises equivalent stress and τ is the maximum shear stress defined as a function of the principal stress values:

$$\tau = \frac{(\sigma_{\text{major}} - \sigma_{\text{minor}})}{2}.$$

Parameter P3 allows you to select which principal stresses are used in this equation for shell elements. With $P3 = 0$, only the in-plane stresses are considered (2-dimensional approach), whereas with $P3 = 1$, they are computed from the full stress tensor (3-dimensional approach). The latter case leads to higher shear fracture risk for the range between uniaxial and biaxial loading. Introduced here is also the pressure influence parameter k_s (P2). Optionally this can be defined as a table with the second dependency being on the effective plastic strain rate $\dot{\varepsilon}^p$, where a negative sign of the first strain rate in the table means that it is in logarithmic scale. The damage initiation history variable evolves according to

$$\omega_D = \int_0^{\varepsilon^p} \frac{d\varepsilon^p}{\varepsilon_D^p}.$$

3. **MSFLD (DITYP = 2).** For the MSFLD initiation option, a function $\varepsilon_D^p = \varepsilon_D^p(\alpha, \dot{\varepsilon}^p)$ represents the plastic strain at onset of damage (P1). This is a function of the ratio of principal plastic strain rates defined as

$$\alpha = \frac{\dot{\varepsilon}_{\text{minor}}^p}{\dot{\varepsilon}_{\text{major}}^p}.$$

The MSFLD criterion is only relevant for shells and with restrictions (discussed in the section [MSFLD and FLD with solid and thick shell elements](#)) for hexa/penta solids/tshells. The principal strains should be interpreted as the in-plane principal strains. For simplicity the plastic strain evolution in this formula is assumed to stem from an associated von Mises flow rule. Hence,

$$\alpha = \frac{s_{\text{minor}}}{s_{\text{major}}}$$

with s being the deviatoric stress. This ensures that the calculation of α , is in a sense, robust at the expense of being slightly inaccurate for materials with anisotropic yield functions and/or non-associated flow rules. Optionally this can be defined as a table with the second dependency being on the effective plastic strain rate, $\dot{\epsilon}^p$, where a negative sign of the first strain rate in the table means that it is in logarithmic scale. For $\dot{\epsilon}^p = 0$, the value of ϵ_D^p is set to a large number to prevent the onset of damage for no plastic evolution. Furthermore, the plastic strain used in this failure criteria is a modified effective plastic strain that only evolves when the pressure is negative, meaning the material is not affected in compression.

This modified plastic strain can be monitored as the second history variable of the initiation history variables in the binary output database. For $P3 = 0$, the damage initiation history variable is calculated directly from the ratio of (modified) plastic strain and the critical plastic strain

$$\omega_D = \max_{t \leq T} \frac{\epsilon^p}{\epsilon_D^p} .$$

This should be interpreted as the maximum value up to this point in time. If $P3 = 1$ the damage initiation history variable is instead incrementally updated from the ratio of (modified) plastic strain and the critical plastic strain

$$\omega_D = \int_0^{\epsilon^p} \frac{d\epsilon^p}{\epsilon_D^p} .$$

For this initiation option with shells, $P2$ is used to determine the layer in the shell where the criterion is evaluated. If $P2 = 0$, the criterion is evaluated in the mid-layer only, whereas if $P2 = 1$, it is evaluated in the outer layers only (bottom and top). This can be used to distinguish between a membrane instability typically used for FLD evaluations ($P2 = 0$) and a bending instability ($P2 = 1$). For shells, as soon as ω_D reaches 1 in any of the integration points of interest, *all* integration points in the shell goes over in damage mode, meaning subsequent damage is applied to the entire element. For solids/tshells, only $P2 = 0$ is currently supported, and when ω_D reaches 1 in the center of the section then all elements in the section goes into damage mode. Again, more details for solids or thick shells are provided in the section titled [MSFLD and FLD with solid and thick shell elements](#).

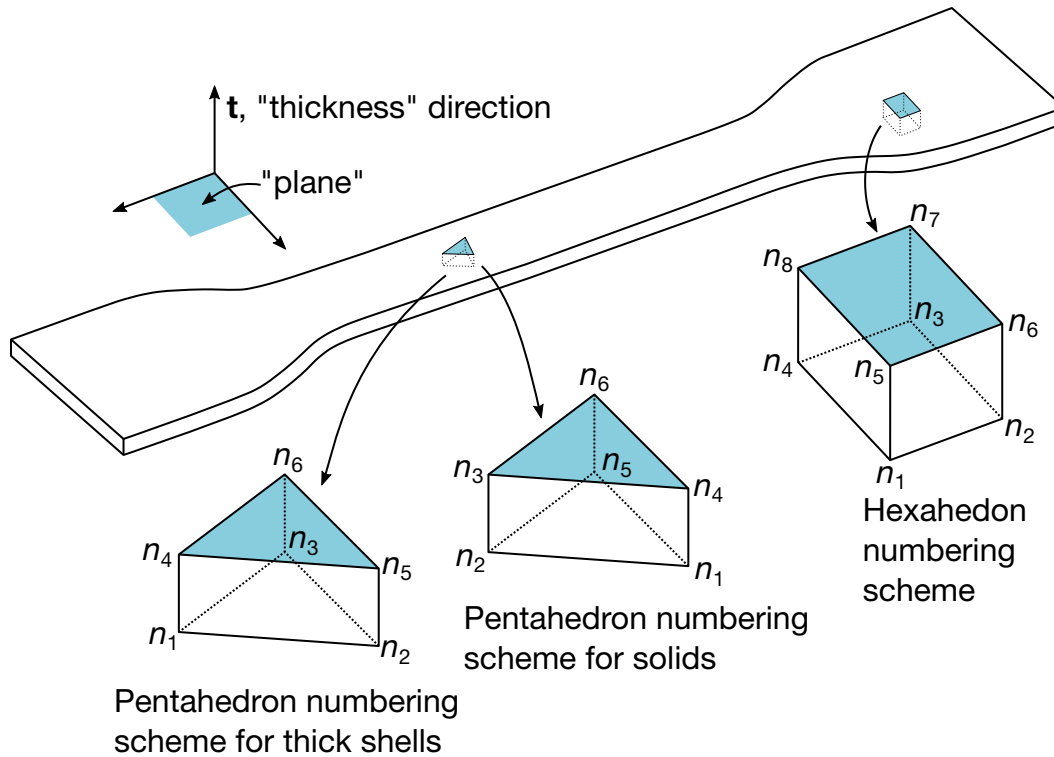

Figure 2-1. Solid and thick shell elements must be oriented in a part in a specific way when using MSFLD or FLD (DITYP = 2 or 3). This figure illustrates the required element numbering scheme and the thickness direction, t .

- FLD (DITYP = 3).** The FLD initiation criterion is identical to MSFLD with one subtle difference: the plastic strain used to evaluate the criteria does not account for the sign of the hydrostatic stress but is instead identical to the effective plastic strain directly from the underlying material model. In other words, it is not the modified plastic strain used in the MSFLD criterion, but apart from that it is an identical criterion.
- Ductile based on normalized principal stress (DITYP = 4).** For the ductile initiation option the plastic strain at the onset of damage (P1) is taken as a function of β and $\dot{\epsilon}^p$, that is $\epsilon_D^p = \epsilon_D^p(\beta, \dot{\epsilon}^p)$. Here β is the normalized principal stress

$$\beta = \frac{q + k_d p}{\sigma_{\text{major}}} ,$$

where p is the pressure, q is the von Mises equivalent stress, σ_{major} is the major principal stress, and k_d is the pressure influence parameter specified in the P2 field. Optionally, this can be defined as a table with the second dependency being on the effective plastic strain rate $\dot{\epsilon}^p$, where a negative sign of the first strain rate in the table means that it is in logarithmic scale. The damage initiation history variable evolves according to

$$\omega_D = \int_0^{\varepsilon^p} \frac{d\varepsilon^p}{\varepsilon_D^p} .$$

MSFLD and FLD with solid and thick shell elements

When using MSFLD or FLD with solid or thick shell elements, the following restrictions apply:

- The part should be a thin walled section, with a well-defined “thickness” direction, t , and associated “plane” indicated in blue in [Figure 2-1](#).
- Only low order hexahedra or pentahedra may be used.
- The same number of elements in t -direction must be used, essentially in the form of an extruded shell mesh. The stack of elements at any location, from bottom to top, comprises the “section”.
- The element numbering scheme must in itself indicate the thickness direction, t , as illustrated in [Figure 2-1](#), for each element in the part.
- The geometry may be curved, but the mesh topology must not change. Thus, for T-intersections and similar geometries, appropriate pre-processing measures must be undertaken.

Damage Evolution, D :

For the evolution of the associated damage variable, D , we introduce the plastic displacement, u^p , which evolves according to

$$\dot{u}^p = \begin{cases} 0 & \omega_D < 1 \\ l\dot{\varepsilon}^p & \omega_D \geq 1 \end{cases}$$

Here l is a characteristic length of the element. Fracture energy is related to plastic displacement as follows

$$G_f = \int_0^{u_f^p} \sigma_y du^p ,$$

where σ_y is the yield stress. The following list enumerates the algorithms available for modelling damage.

1. **Linear (DETYP = 0).** With this option, if $\alpha = 0$ (Q3) and Q1 is positive, the damage variable evolves linearly with the plastic displacement after onset of damage:

$$\dot{D} = \frac{\dot{u}^p}{u_f^p} .$$

Here u_f^p is the plastic displacement at failure (Q1).

If Q1 is negative, then -Q1 refers to a table that defines u_f^p as a function of triaxiality and damage, that is, $u_f^p = u_f^p(\eta, D)$. In this case with $\alpha = 0$, the damage evolution law generalizes to:

$$\dot{D} = \frac{\dot{u}^p}{\frac{\partial u_f^p}{\partial D}} .$$

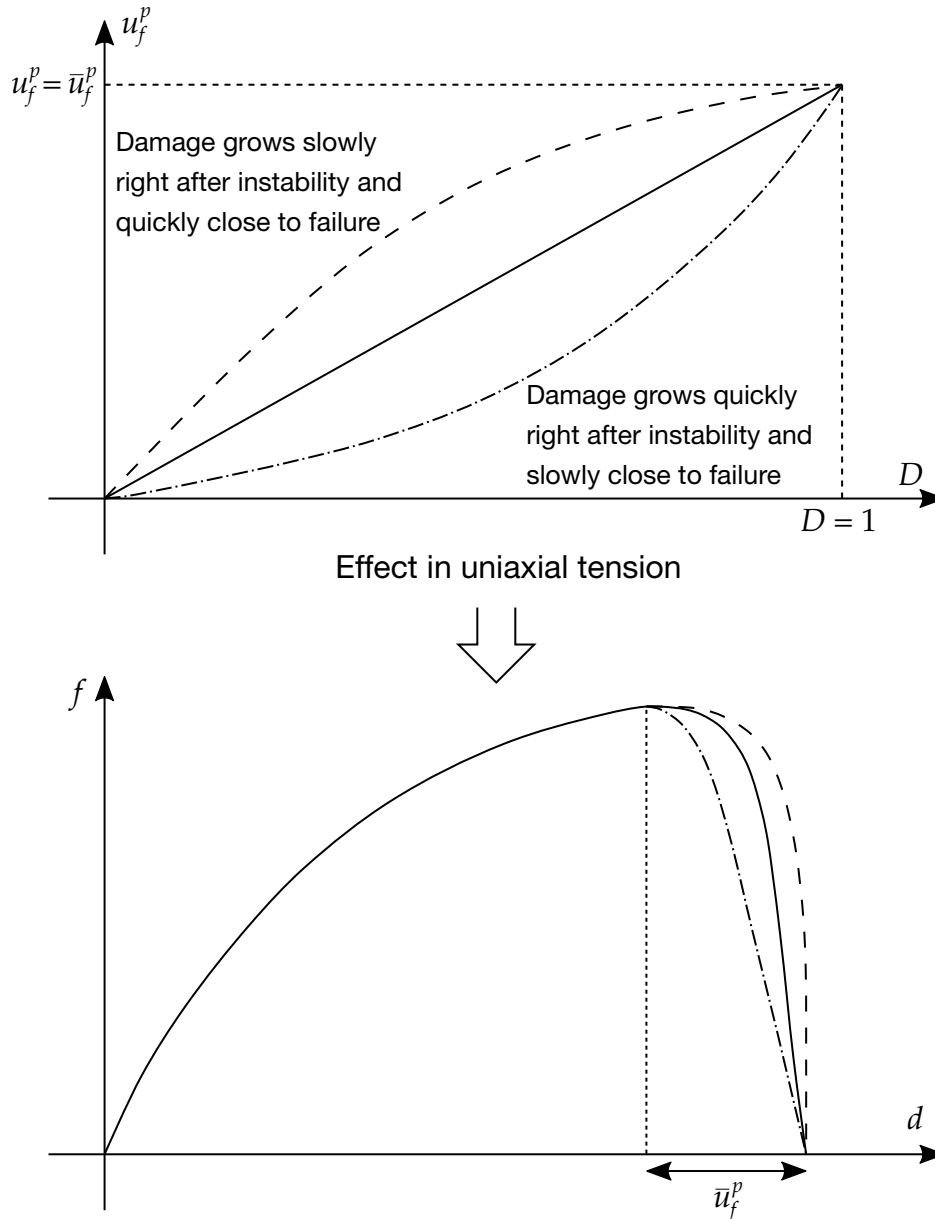

Figure 2-2. Top plot illustrates plastic displacement at failure as a function of damage for a given triaxiality for DETYP = 0 and $\alpha = 0$. The different curves illustrate different possible types of post-instability characteristics. The bottom plot illustrates qualitatively how these curves may interact in a tension test. d is the displacement and f is the force.

For a fixed triaxiality, η , $\bar{u}_f^p := u_f^p(\eta, 1)$ defines the plastic displacement at failure, and the shape of $u_f^p(\eta, D)$ as a function of D determines the post-instability characteristics.

A linear curve, as illustrated by the solid line in Figure 2-2, corresponds exactly to a constant plastic displacement to failure equal to \bar{u}_f^p and can be seen as a reference curve for this discussion. For simplicity assume uniaxial tension ($\eta =$

1/3). A curve with positive curvature, represented by the dash-dots in [Figure 2-2](#), means that damage evolves quickly right after onset of instability and more slowly when approaching failure. In contrast, damage evolves slowly early and more quickly later on for a curve with negative curvature, represented by the dashes. The qualitative effect these curves have in a uniaxial tension test is also illustrated. The correlation between a damage curve and the actual behavior in tests is not straightforward, thus these curves need to be established on a trial-and-error basis.

For $\alpha > 0$ and $u_f^p > 0$, the damage evolution follows an exponential law given by

$$D = \frac{1 - e^{-\alpha \frac{u^p}{u_f^p}}}{1 - e^{-\alpha}}$$

where $u^p = \int \dot{u}^p$.

2. **Linear (DETYP = 1).** With this option the damage variable evolves linearly as follows

$$\dot{D} = \frac{\dot{u}^p}{u_f^p} ,$$

where $u_f^p = 2G_f / \sigma_{y_0}$ and σ_{y_0} is the yield stress when failure criterion is reached.

***MAT_ADD_DAMAGE_GISSMO_{OPTION}**

<BLANK>

STOCHASTIC

Many of the constitutive models in LS-DYNA do not allow failure and erosion. *MAT_ADD_DAMAGE_GISSMO provides a way to include damage and failure in these models. GISSMO is the “generalized incremental stress-state dependent damage model.” It applies to nonlinear element formulations including 2D continuum elements, beam element formulation 1, 3D shells (including isogeometric shells), 3D thick shells, 3D solids (including isogeometric solids), and SPH. See remarks for details. The STOCHASTIC option allows spatially varying failure behavior. See *DEFINE_STOCHASTIC_VARIATION for additional information.

*MAT_ADD_DAMAGE_GISSMO originates from splitting *MAT_ADD_EROSION. Only “sudden” failure criteria without damage remain in *MAT_ADD_EROSION.

NOTE: Use *CONTROL_MAT to disable all *MAT_ADD_DAMAGE_GISSMO commands in a model.

Card 1	1	2	3	4	5	6	7	8
Variable	MID		DTYP	REFSZ	NUMFIP			
Type	A		F	F	F			
Default	none		0.0	0.0	1.0			

Card 2	1	2	3	4	5	6	7	8
Variable	LCSDG	ECRIT	DMGEXP	DCRIT	FADEXP	LCREGD	INSTF	
Type	F	F	F	F	F	F	I	
Default	0.0	0.0	1.0	0.0	1.0	0.0	0	

Card 3	1	2	3	4	5	6	7	8
Variable	LCSRS	SHRF	BIAXF	LCDLIM	MIDFAIL	HISVN	SOFT	LP2BI
Type	F	F	F	F	F	F	F	F
Default	0.0	0.0	0.0	0.0	0.0	0.0	0.0	0.0

VARIABLE**DESCRIPTION**

MID	Material identification for which this erosion definition applies. A unique number or label must be specified (see *PART).
DTYP	<p>DTYP is interpreted digit-wise as follows:</p> $DTYP = [NM] = M + 10 \times N$ <p>M.EQ.0: Damage is accumulated, but there is no coupling to flow stress and no failure.</p> <p>M.EQ.1: Damage is accumulated, and element failure occurs for $D = 1$. Coupling of damage to flow stress depending on parameters, see remarks below.</p> <p>N.EQ.0: Equivalent plastic strain is the driving quantity for the damage. (To be more precise, it's the history variable that LS-PrePost blindly labels as "plastic strain." What this history variable actually represents depends on the material model.)</p> <p>N.GT.0: The N^{th} additional history variable is the driving quantity for damage. These additional history variables are the same ones flagged by the *DATABASE_EXTENT_BINARY keyword's NEIPS and NEIPH fields. For example, for solid elements with *MAT_187, setting $N = 6$ causes volumetric plastic strain to be the driving quantity for the GISSMO damage.</p>
REFSZ	<p>Reference element size for which an additional output of damage (and potentially plastic strain) will be generated. This is necessary to ensure the applicability of resulting damage quantities when transferred to different mesh sizes.</p> <p>GT.0: Reference size related damage values are written to history variables $ND + 9$ and $ND + 10$. These damage values</p>

VARIABLE**DESCRIPTION**

are computed in the same fashion as the actual damage, just with the given reference element size.

LT.0: The reference element size is |REFSZ|. In addition to the reference size related damage values, a corresponding plastic strain is computed and written to history variable ND + 17. See remarks for details.

NUMFIP

Number or percentage of failed integration points prior to element deletion (default value is 1). When the material is a composite with different through-the-thickness material types defined using *PART_COMPOSITE, then values other than 1 will not work correctly; use *DEFINE_ELEMENT_EROSION instead.

GT.0.0: Number of integration points which must fail before element is deleted.

LT.0.0: Applies only to shells. |NUMFIP| is the percentage of layers which must fail before an element is deleted. For shell formulations with 4 integration points per layer, the layer is considered failed if any of the integration points in the layer fails.

LCSDG

Failure strain curve/table or function:

GT.0.0: Load curve ID or table ID. As a load curve, it defines equivalent plastic strain to failure as a function of triaxiality. As a table, it defines for each Lode parameter value (between -1 and 1) a load curve ID giving the equivalent plastic strain to failure as a function of triaxiality for that Lode parameter value. With HISVN \neq 0, a 3D table can be used, where failure strain is a function of the history variable (TABLE_3D), Lode parameter (TABLE), and triaxiality (CURVE). With HISVN = 0, a 3D table introduces thermal effects, that is, failure strain is a function of temperature (TABLE_3D), Lode parameter (TABLE), and triaxiality (CURVE). As a 4D table, failure strain is a function of strain rate (TABLE_4D), temperature (TABLE_3D), Lode parameter (TABLE), and triaxiality (CURVE).

LT.0.0: |LCSDG| is the ID of a function (*DEFINE_FUNCTION) with the arguments triaxiality η , Lode parameter L , plastic strain rate $\dot{\epsilon}^p$, temperature T , history variable HISVN, and element size l_e : $f(\eta, L, \dot{\epsilon}^p, T, \text{HISVN}, l_e)$. Note that the

VARIABLE	DESCRIPTION
ECRIT	<p data-bbox="639 254 1425 323">sequence of the arguments is important, not their names.</p> <p data-bbox="488 373 1240 403">Critical plastic strain (material instability); see below.</p> <p data-bbox="524 428 1425 930">LT.0.0: ECRIT is either a load curve ID defining critical equivalent plastic strain versus triaxiality or a table ID defining critical equivalent plastic strain as a function of triaxiality and Lode parameter (as in LCSDG). With $HISVN \neq 0$, a 3D table can be used, where critical strain is a function of the history variable (TABLE_3D), Lode parameter (TABLE), and triaxiality (CURVE). With $HISVN = 0$, a 3D table introduces thermal effects, that is, critical strain is a function of temperature (TABLE_3D), Lode parameter (TABLE), and triaxiality (CURVE). As a 4D table, critical strain is a function of strain rate (TABLE_4D), temperature (TABLE_3D), Lode parameter (TABLE), and triaxiality (CURVE).</p> <p data-bbox="524 953 1425 1022">EQ.0.0: Fixed value DCRIT defining critical damage is read (see below).</p> <p data-bbox="524 1045 1425 1119">GT.0.0: Fixed value for stress-state independent critical equivalent plastic strain</p>
DMGEXP	Exponent for nonlinear damage accumulation; see remarks.
DCRIT	Damage threshold value (critical damage). If a load curve of critical plastic strain or fixed value is given by ECRIT, input is ignored.
FADEXP	<p data-bbox="488 1350 1117 1379">Exponent for damage-related stress fadeout:</p> <p data-bbox="524 1402 1425 1667">LT.0.0: FADEXP is a load curve ID or table ID. As a load curve it gives the fading exponent as a function of element size. As a table, it specifies the fading exponent as a function triaxiality (TABLE) and element size (CURVE). For 3D tables, it specifies the fading exponent as a function Lode parameter (TABLE_3D), triaxiality (TABLE), and element size (CURVE).</p> <p data-bbox="524 1690 1005 1724">GT.0.0: Constant fading exponent</p>
LCREGD	Load curve ID or table ID defining element size dependent regularization factors for equivalent plastic strain to failure:

VARIABLE	DESCRIPTION
	<p>GT.0.0: Load curve ID (regularization factor as a function of element size) or table ID (regularization factor vs. element size curves vs. effective rate)</p> <p>LT.0.0: LCREGD is a table ID (regularization factor vs. element size curves vs. triaxiality) or a 3D table ID (regularization factor as function of Lode parameter, triaxiality, and element size). This table provides an alternative to the use of SHRF and BIAXF for defining the effect of triaxiality on element size regularization of equivalent plastic strain to failure.</p>
INSTF	<p>Flag for governing the behavior of instability measure, F, and fading exponent, FADEXP (see Remarks):</p> <p>EQ.0: F is incrementally updated, and FADEXP, if from a table, is allowed to vary.</p> <p>EQ.1: F is incrementally updated, and FADEXP is kept constant after $F = 1$.</p> <p>EQ.2: F is only 0 or 1 (after ECRIT is reached), and FADEXP, if from a table, is allowed to vary.</p> <p>EQ.3: F is only 0 or 1 (after ECRIT is reached), and FADEXP is kept constant after $F = 1$.</p>
LCSRS	<p>Load curve ID or table ID. Load curve ID defining failure strain scaling factor for LCSDG as a function of strain rate. If the first strain rate value in the curve is negative, it is assumed that all strain rate values are given as a natural logarithm of the strain rate. <i>The curve should not extrapolate to zero or failure may occur at low strain.</i> Table ID defining failure strain scaling factor as a function of strain rate (TABLE) and triaxiality (CURVE).</p> <p>GT.0: Scale ECRIT.</p> <p>LT.0: Do not scale ECRIT.</p>
SHRF	<p>Reduction factor for regularization for shear stress states. This parameter can be defined between -1.0 and +1.0. See remarks below.</p>
BIAXF	<p>Reduction factor for regularization for biaxial stress states. This parameter can be defined between -1.0 and +1.0. See remarks below.</p>

VARIABLE	DESCRIPTION
LCDLIM	Load curve ID defining damage limit values as a function of triaxiality. Damage can be restricted to values less than 1.0 to prevent further stress reduction and failure for certain triaxialities.
MIDFAIL	<p>Mid-plane failure option for shell elements. If active, then critical strain is only checked at the mid-plane integration point (IP), meaning an odd number for NIP should be used. The other integration points compute their damage, but no coupling to the stresses is done first. As soon as the mid-plane IP reaches ECRIT/DCRIT, then all the other IPs are also checked.</p> <p>EQ.0.0: Inactive.</p> <p>EQ.1.0: Active. Those of the non-mid-plane IPs that are already above their critical value immediately start to reduce the stresses. Those still below the critical value still do not couple, only if they reach their criterion.</p> <p>EQ.2.0: Active. All of the non-mid-plane IPs immediately start to reduce the stresses. NUMFIP is active.</p> <p>EQ.3.0: Active. Same as 2 but when $D = 1$ is reached in the middle integration point, the element is eroded instantaneously. NUMFIP is disregarded.</p> <p>EQ.4.0: Active. Damage and failure are applied only to the mid-point. When $D = 1$ at the midpoint, the element is eroded. NUMFIP is disregarded. Integration points away from the midplane see no stress reduction and no failure.</p>
HISVN	<p>History variable used to evaluate the 3D table LCSDG (and optionally 3D table ECRIT < 0):</p> <p>GT.0.0: Constant value</p> <p>LT.0.0: The constant value found at position HISVN where HISVN is the location in the history array of *INITIAL_STRESS_SHELL/SOLID.</p>
SOFT	<p>Softening reduction factor for failure strain in crashfront elements. Crashfront elements are elements that are direct neighbors of failed (deleted) elements.</p> <p>EQ.0.0: Inactive</p> <p>GT.0.0: Plastic failure strain, ϵ_f (LCSDG), and critical plastic strain, $\epsilon_{p,loc}$ (ECRIT), will be scaled by SOFT.</p>

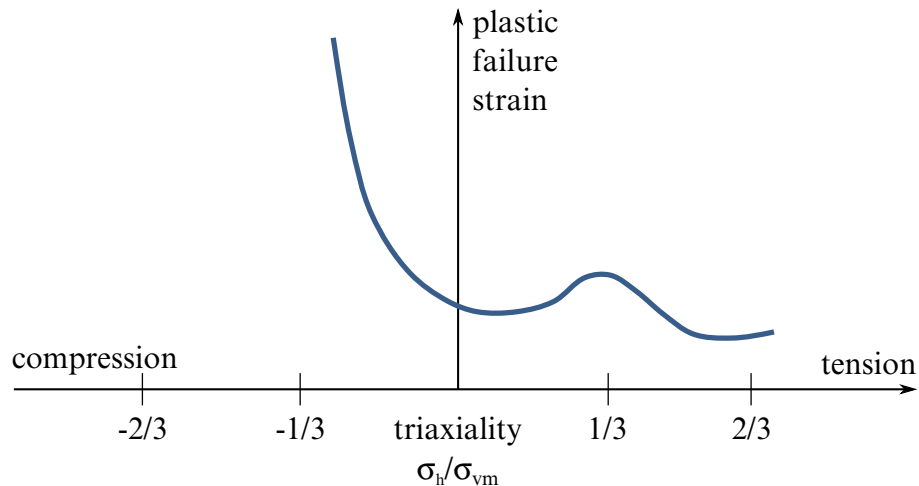

Figure 2-3. Typical failure curve for metal sheet, modeled with shell elements.

VARIABLE	DESCRIPTION
	LT.0.0: Only plastic failure strain, ϵ_f (LCSDG), will be scaled by SOFT .
LP2BI	<p>Option to use a bending indicator instead of the Lode parameter. Everywhere in this keyword's manual description, the term "Lode parameter" can/should be replaced by the expression "bending indicator," which is adopted from *MAT_258 (compare with variable Ω). Only available for shell elements. NUMFIP = 1 is mandatory in this case.</p> <p>EQ.0.0: Inactive.</p> <p>EQ.1.0: Active. Constant regularization (LCREGD) applied.</p> <p>EQ.2.0: Active. Regularization (LCRGED) fully applied under pure membrane loading ($\Omega = 0$) but not at all under pure bending ($\Omega = 1$). Linear interpolation in between.</p>

Remarks:

The GISSMO damage model is a phenomenological formulation that allows for an incremental description of damage accumulation, including softening and failure. It is intended to provide a maximum in variability for the description of damage for a variety of metallic materials, such as *MAT_024, *MAT_036, and *MAT_103. The input of parameters is based on tabulated data, allowing the user to directly convert test data to numerical input. The model was originally developed by Neukamm et al. [2008] and further investigated and enhanced by Effelsberg et al. [2012] and Andrade et al. [2014, 2016].

The model is based on an incremental formulation of damage accumulation:

$$\Delta D = \frac{\text{DMGEXP} \times D^{\left(1 - \frac{1}{\text{DMGEXP}}\right)}}{\varepsilon_f} \Delta \varepsilon_p$$

where,

D Damage value ($0 \leq D \leq 1$). For numerical reasons, D is initialized to a value of 10^{-20} for all damage types in the first time step.

ε_f Equivalent plastic strain to failure, determined from LCSDG as a function of the current triaxiality value η (and Lode parameter L as an option).

A typical failure curve LCSDG for metal sheet, modelled with shell elements is shown in [Figure 2-3](#). Triaxiality should be monotonically increasing in this curve. A reasonable range for triaxiality is $-2/3$ to $2/3$ if shell elements are used (plane stress).

For 3-dimensional stress states (solid elements), the possible range of triaxiality goes from $-\infty$ to $+\infty$, but to get a good resolution in the internal load curve discretization (depending on parameter LCINT of *CONTROL_SOLUTION) you should define lower limits, such as -1 to 1 if LCINT = 100 (default).

$\Delta \varepsilon_p$ Equivalent plastic strain increment

For constant values of failure strain, this damage rate can be integrated to get a relation of damage and actual equivalent plastic strain:

$$D = \left(\frac{\varepsilon_p}{\varepsilon_f}\right)^{\text{DMGEXP}}, \quad \text{for } \varepsilon_f = \text{constant}$$

Triaxiality, η , as a measure of the current stress state is defined as

$$\eta = \frac{\sigma_H}{\sigma_M},$$

with hydrostatic stress, σ_H , and von Mises stress, σ_M . Lode parameter L as an additional measure of the current stress state is defined as

$$L = \frac{27}{2} \frac{J_3}{\sigma_M^3},$$

with third invariant of the stress deviator, J_3 .

For DTYP = 0, damage is accumulated according to the description above, yet no softening and failure is taken into account. Thus, parameters ECRIT, DCRIT and FADEXP will not have any influence. This option can be used to calculate pre-damage in multi-stage deformations without influencing the simulation results.

For DTYPE = 1, elements will be deleted if $D \geq 1$.

Depending on the set of parameters given by ECRIT (or DCRIT) and FADEXP, a Le-maitre-type coupling of damage and stress (*effective stress concept*) can be used.

Three principal ways to define damage can be used:

1. Input of a fixed value of critical plastic strain (ECRIT > 0.). As soon as the magnitude of plastic strain reaches this value, the current damage parameter D is stored as critical damage DCRIT and the damage coupling flag is set to unity, in order to facilitate an identification of critical elements in post-processing. From this point on, damage is coupled to the stress tensor using the following relation:

$$\sigma = \tilde{\sigma} \left[1 - \left(\frac{D - \text{DCRIT}}{1 - \text{DCRIT}} \right)^{\text{FADEXP}} \right]$$

This leads to a continuous reduction of stress, up to the load-bearing capacity completely vanishing as D reaches unity. The fading exponent FADEXP can be element size dependent to allow for the consideration of an element-size dependent amount of energy to be dissipated during element fade-out.

2. Input of a load curve defining critical plastic strain as a function of triaxiality (ECRIT < 0.), pointing to load curve ID |ECRIT|. This allows for a definition of triaxiality-dependent material instability, which takes account of instability and localization occurring depending on the actual load case. One possibility is the use of instability curves predicted by instability models (e.g., Swift, Hill, Marciniak-Kuczynski, etc.). Another possibility is the use of a transformed Forming Limit Diagram as an input for the expected onset of softening and localization. Using this load curve, the instability measure F is accumulated using the following relation, which is similar to the accumulation of damage D except for the instability curve is used as an input:

$$\Delta F = \frac{\text{DMGEXP}}{\varepsilon_{p,loc}} F^{\left(1 - \frac{1}{\text{DMGEXP}}\right)} \Delta \varepsilon_p$$

with,

F Instability measure ($0 \leq F \leq 1$).

$\varepsilon_{p,loc}$ Equivalent plastic strain to instability, determined from ECRIT

$\Delta \varepsilon_p$ Equivalent plastic strain increment

As soon as the instability measure F reaches unity, the current value of damage D in the respective element is stored. Damage will from this point on be coupled to the flow stress using the relation described above.

3. If no input for ECRIT is made, parameter DCRIT will be considered. Coupling of damage to the stress tensor starts if this value (*damage threshold*) is exceeded

($0 \leq \text{DCRIT} \leq 1$). Coupling of damage to stress is done using the relation described above.

This input allows for the use of extreme values also – for example, $\text{DCRIT} = 1.0$ would lead to no coupling at all, and element deletion under full load (brittle fracture).

The values of SHRF and BIAXF generally lie between 0.0 and 1.0 where 0.0 means full regularization and 1.0 means no regularization under shear (triaxiality = 0.0 for $\text{SHRF} = 1.0$) or biaxial tension (triaxiality = 2/3 for $\text{BIAXF} = 1.0$). Any other intermediate triaxiality follows a linear interpolation between triaxiality 0.0 and 1/3 and also between triaxiality 1/3 and 2/3. Notice that a full regularization is always undertaken for a one-dimensional tensile stress state (triaxiality = 1/3) according to the factors defined under LCREGD . For the sake of generalization, both SHRF and BIAXF can also assume negative values (e.g., $\text{SHRF} = -1.0$ and $\text{BIAXF} = -1.0$). In this case, regularization is affected not at triaxialities 0.0 and 2/3 but rather at the triaxialities where the failure curve (LCSDG) crosses the instability curve ($-\text{ECRIT}$). The use of a triaxiality-dependent regularization approach may be necessary because simple regularization only depending on the element size can be unrealistic for certain stress states.

If the results of a first simulation should be transferred to a second computation with potentially modified mesh size, such as mapping from forming to crash, it might be necessary to alter damage values (and maybe plastic strain) as well. For that purpose, reference element size REFSZ can be defined. With $\text{REFSZ} > 0$, corresponding damage is computed in the same fashion as the actual damage, just with the given reference element size instead, and written to history variable $\text{ND} + 9$. An alternative approach is available with the definition of $\text{REFSZ} < 0$. In that case, a plastic strain with regard to $|\text{REFSZ}|$ is computed first:

$$\Delta \varepsilon_p^{|\text{REFSZ}|} = \Delta \varepsilon_p \frac{\varepsilon_p^f(|\text{REFSZ}|) - \varepsilon_p^{\text{ECRIT}}}{\varepsilon_p^f(l_e) - \varepsilon_p^{\text{ECRIT}}} \quad (\text{if } F \geq 1)$$

The accumulated value of that is written to history variable $\text{ND} + 17$. Afterwards, damage with respect to the $|\text{REFSZ}|$ is computed similarly to the standard damage accumulation, only using this new reference plastic strain:

$$\Delta D^{|\text{REFSZ}|} = \frac{\text{DMGEXP} \times (D^{|\text{REFSZ}|})^{(1 - \frac{1}{\text{DMGEXP}})}}{\varepsilon_p^f(|\text{REFSZ}|)} \Delta \varepsilon_p^{|\text{REFSZ}|}$$

This “reference damage” is stored on history variable $\text{ND} + 9$.

History Variables:

History variables of the GISSMO damage model are written to the post-processing database. Therefore, NEIPH and NEIPS must be set in $*\text{DATABASE_EXTENT_BINARY}$.

The damage history variables start at position ND, which is displayed in d3hsp file as, for example, "first damage history variable = 6" which means that ND = 6. For example, if you wish to view the damage parameter (first GISSMO history variable) for a *MAT_024 shell element, you must set NEIPS = 6. In LS-PrePost, you access the damage parameter as history variable #6.

History Variable #	Description
ND	Damage parameter D ($10^{-20} < D \leq 1$)
ND + 1	Damage threshold DCRIT
ND + 2	Domain flag for damage coupling (0: no coupling, 1: coupling)
ND + 3	Triaxiality variable, $\eta = \sigma_H / \sigma_M$
ND + 4	Equivalent plastic strain
ND + 5	Regularization factor for failure strain (determined from LCREGD)
ND + 6	Exponent for stress fading FADEXP
ND + 7	Calculated element size, l_e
ND + 8	Instability measure F
ND + 9	Resultant damage parameter D for element size REFSZ
ND + 10	Resultant damage threshold DCRIT for element size REFSZ
ND + 11	Averaged triaxiality: $\eta_{n+1}^{\text{avg}} = \frac{1}{D_{n+1}} (D_n \times \eta_n^{\text{avg}} + (D_{n+1} - D_n) \times \eta_{n+1})$
ND + 12	Lode parameter value L (only calculated if LCSDG refers to a table)
ND + 13	Alternative damage value: $D^{1/\text{DMGEXP}}$
ND + 14	Averaged Lode parameter:

History Variable #	Description
	$L_{n+1}^{\text{avg}} = \frac{1}{D_{n+1}} (D_n \times L_n^{\text{avg}} + (D_{n+1} - D_n) \times L_{n+1})$
ND + 15	MIDFAIL control flag (set to -1 in case mid-plane IP reaches ECRIT/DCRIT)
ND + 16	Number of IPs/layers (NUMFIP > 0/< 0) that must fail before an element gets deleted
ND + 17	Plastic strain value related to reference element size (only if REFSZ < 0)
ND + 18	Effective damage value (stress scaling factor)
ND + 19	History variable for 3D table LCSDG (only if HISVN ≠ 0)
ND + 20	Random scale factor on failure strain (only if STOCHASTIC option is used)

***MAT_ADD_EROSION**

Many of the constitutive models in LS-DYNA do not allow failure and erosion. The ADD_EROSION option provides a way of including failure in these models. This option can also be applied to constitutive models that already include other failure/erosion criteria.

Each of the failure criteria defined here are applied independently, and once a sufficient number of those criteria are satisfied according to NCS, the element is deleted from the calculation.

This keyword applies to nonlinear element formulations including 2D continuum elements, beam formulations 1 and 11, 3D shell elements (including isogeometric shells), 3D thick shell elements, 3D solid elements (including isogeometric solids), and SPH.

Damage models GISSMO and DIEM are still available using IDAM on Card 3 for backward compatibility. The keywords *MAT_ADD_DAMAGE_DIEM and *MAT_ADD_DAMAGE_GISSMO are preferable methods for adding damage. A combination of *MAT_ADD_EROSION failure criteria with damage from *MAT_ADD_DAMAGE_DIEM/GISSMO is possible as long as IDAM = 0 is used.

NOTE: All *MAT_ADD_EROSION commands in a model can be disabled by using *CONTROL_MAT.

Card Summary:

Card 1. This card is required.

MID	EXCL	MXPRES	MNEPS	EFFEPS	VOLEPS	NUMFIP	NCS
-----	------	--------	-------	--------	--------	--------	-----

Card 2. This card is required.

MNPRES	SIGP1	SIGVM	MXEPS	EPSSH	SIGTH	IMPULSE	FAILTM
--------	-------	-------	-------	-------	-------	---------	--------

Card 3. This card is optional.

IDAM							LCREGD
------	--	--	--	--	--	--	--------

Card 4. This card is optional.

LCFLD	NSFF	EPSTHIN	ENGCRT	RADCRT	LCEPS12	LCEPS13	LCEPSMX
-------	------	---------	--------	--------	---------	---------	---------

Card 5. This card is optional.

DTEFLT	VOLFRAC	MXTMP	DTMIN				
--------	---------	-------	-------	--	--	--	--

Data Card Definitions:

Card 1	1	2	3	4	5	6	7	8
Variable	MID	EXCL	MXPRES	MNEPS	EFFEPS	VOLEPS	NUMFIP	NCS
Type	A	F	F	F	F	F	F	F
Default	none	0.0	0.0	0.0	0.0	0.0	1.0	1.0/0.0

VARIABLE**DESCRIPTION**

MID	Material identification for which this erosion definition applies. A unique number or label must be specified (see *PART).
EXCL	<p>The exclusion number (default value of 0.0 is recommended). For any failure value in *MAT_ADD_EROSION which is set to this exclusion number, the associated failure criterion is not invoked. Or in other words, only the failure values which are not set to the exclusion number are invoked. The default value of EXCL (0.0) eliminates from consideration any failure criterion whose failure value is left blank or set to 0.0.</p> <p>As an example, to prevent a material from developing tensile pressure, the user could specify an unusual value for the exclusion number, such as 1234, set MNPRES to 0.0, and set all the other failure values in *MAT_ADD_EROSION to 1234. However, use of an exclusion number in this way is nonessential since the same effect could be achieved without use of the exclusion number by setting MNPRES to a very small negative value and leaving all the other failure values blank (or set to zero).</p>
MXPRES	Maximum pressure at failure, P_{\max} . If the value is exactly zero, it is automatically excluded to maintain compatibility with old input files.
MNEPS	Minimum principal strain at failure, ϵ_{\min} . If the value is exactly zero, it is automatically excluded to maintain compatibility with old input files.

VARIABLE	DESCRIPTION
EFFEPS	<p>Maximum effective strain at failure:</p> $\epsilon_{\text{eff}} = \sum_{ij} \sqrt{\frac{2}{3} \epsilon_{ij}^{\text{dev}} \epsilon_{ij}^{\text{dev}}} .$ <p>If the value is exactly zero, it is automatically excluded to maintain compatibility with old input files. If the value is negative, then EFFEPS is the effective plastic strain at failure. In combination with cohesive elements, EFFEPS is the maximum effective in-plane strain.</p>
VOLEPS	<p>Volumetric strain at failure,</p> $\epsilon_{\text{vol}} = \epsilon_{11} + \epsilon_{22} + \epsilon_{33} ,$ <p>or</p> $\ln(\text{relative volume}) .$ <p>VOLEPS can be a positive or negative number depending on whether the failure is in tension or compression, respectively. If the value is exactly zero, it is automatically excluded to maintain compatibility with old input files.</p>
NUMFIP	<p>Number or percentage of failed integration points prior to element deletion (default is 1). See Remark 2. NUMFIP does not apply to higher order solid element types 24, 25, 26, 27, 28, and 29, rather see the variable VOLFRAC. Also, when the material is a composite defined with *PART_COMPOSITE with different materials through-the-thickness, this field should not be used; use *DEFINE_ELEMENT_EROSION instead.</p> <p>GT.0.0: Number of integration points which must fail before element is deleted</p> <p>LT.0.0: Applies only to shells. NUMFIP is the percentage of integration points which must exceed the failure criterion before the element fails. If NUMFIP < -100, then NUMFIP -100 is the number of failed integration points prior to element deletion.</p>
NCS	<p>Number of failure conditions to satisfy before failure occurs. For example, if SIGP1 and SIGVM are defined and if NCS = 2, both failure criteria must be met before element deletion can occur. The default is set to unity.</p>

Card 2	1	2	3	4	5	6	7	8
Variable	MNPRES	SIGP1	SIGVM	MXEPS	EPSSH	SIGTH	IMPULSE	FAILTM
Type	F	F	F	F	F	F	F	F
Default	none	none	none	none	none	none	none	none

VARIABLE**DESCRIPTION**

MNPRES	Minimum pressure at failure, P_{\min} .
SIGP1	Maximum principal stress at failure, σ_{\max} .
SIGVM	Equivalent stress at failure, $\bar{\sigma}_{\max}$ LT.0: -SIGVM is a load curve ID giving the equivalent stress at failure as a function of the effective strain rate (the curve should not extrapolate to zero or failure may occur at low strain).
MXEPS	Variable to invoke a failure criterion based on maximum principal strain. GT.0.0: Maximum principal strain at failure, ϵ_{\max} LT.0.0: -MXEPS is the ID of a curve giving maximum principal strain at failure as a function of effective strain rate (The curve should not extrapolate to zero or failure may occur at low strain). A filter is applied to the effective strain rate according to DTEFLT (see Card 5).
EPSSH	Tensorial shear strain at failure, $\gamma_{\max}/2$
SIGTH	Threshold stress, σ_0
IMPULSE	Stress impulse for failure, K_f
FAILTM	Failure time. When the problem time exceeds the failure time, the material is removed. GT.0: Failure time is active during any phase of the analysis. LT.0: Failure time is set to FAILTM . This criterion is inactive during the dynamic relaxation phase.

Damage Model Card. The following card is optional.

Card 3	1	2	3	4	5	6	7	8
Variable	IDAM							LCREGD
Type	A8							F
Default	0.0							0.0

VARIABLE**DESCRIPTION**

IDAM

Flag for damage model.

EQ.0: No damage model is used.

NE.0: Damage models GISSMO or DIEM, see manuals of R10 and before. Still available here for backward compatibility (see preferred keywords *MAT_ADD_DAMAGE_DIEM/GISSMO as of R11).

LCREGD

Load curve ID defining element size dependent regularization factors. This feature can be used with the standard failure criteria of Cards 1 (MXPRES, MNEPS, EFFEPS, VOLEPS), 2 (MNPRES, SIGP1, SIGVM, MXEPS, EPSSH, IMPULSE) and 4 (LCFLD, EPSTHIN).

Additional Failure Criteria Card. This card is optional.

Card 4	1	2	3	4	5	6	7	8
Variable	LCFLD	NSFF	EPSTHIN	ENGCRIT	RADCRIT	LCEPS12	LCEPS13	LCEPSMX
Type	F	F	F	F	F	I	I	I
Default	0.0	0.0	0.0	0.0	0.0	0	0	0

VARIABLE	DESCRIPTION
LCFLD	Load curve ID or table ID. Load curve defines the Forming Limit Diagram, where minor engineering strains in percent are defined as abscissa values and major engineering strains in percent are defined as ordinate values. Table defines for each strain rate (LCFLD > 0) or for each shell thickness (LCFLD < 0) an associated FLD curve. The forming limit diagram is shown in Figure M39-1 . When defining the curve, list pairs of minor and major strains starting with the left most point and ending with the right most point. This criterion is only available for shell elements.
NSFF	Number of explicit time step cycles for stress fade-out used in the LCFLD criterion. Default is 10.
EPSTHIN	Thinning strain at failure for thin and thick shells. GT.0.0: Individual thinning for each integration point from z-strain LT.0.0: Averaged thinning strain from element thickness change
ENGCRT	Critical energy for nonlocal failure criterion; see Remark 1i below.
RADCRT	Critical radius for nonlocal failure criterion; see Remark 1i below.
LCEPS12	Load curve ID defining in-plane shear strain limit γ_{12}^c as a function of element size. See Remark 1j .
LCEPS13	Load curve ID defining through-thickness shear strain limit γ_{13}^c as a function of element size. See Remark 1j .
LCEPSMX	Load curve ID defining in-plane major strain limit ϵ_1^c as a function of element size. See Remark 1j .

Additional Failure Criteria Card. This card is optional.

Card 5	1	2	3	4	5	6	7	8
Variable	DTEFLT	VOLFRAC	MXTMP	DTMIN				
Type	F	F	F	F				
Default	↓	0.5	none	none				

VARIABLE	DESCRIPTION
DTEFLT	The time period (or inverse of the cutoff frequency) for the low-pass filter applied to the effective strain rate when MXEPS is negative. If DTEFLT is set to zero or left blank, no filtering of the effective strain rate is performed in the determination of the maximum principal strain to failure.
VOLFRAC	The volume fraction required to fail before the element is deleted. The default is 0.5. It is used for higher order solid element types 24, 25, 26, 27, 28, and 29, and all isogeometric solids and shell elements. See Remark 4 .
MXTMP	Maximum temperature at failure
DTMIN	Minimum time step size at failure

Remarks:

1. **Failure Criteria.** In addition to failure time, supported criteria for failure are:
 - a) $P \geq P_{\max}$, where P is the pressure (positive in compression), and P_{\max} is the maximum pressure at failure
 - b) $\varepsilon_3 \leq \varepsilon_{\min}$, where ε_3 is the minimum principal strain, and ε_{\min} is the minimum principal strain at failure
 - c) $P \leq P_{\min}$, where P is the pressure (positive in compression), and P_{\min} is the minimum pressure at failure
 - d) $\sigma_1 \geq \sigma_{\max}$, where σ_1 is the maximum principal stress, and σ_{\max} is the maximum principal stress at failure
 - e) $\sqrt{\frac{3}{2} \sigma'_{ij} \sigma'_{ij}} \geq \bar{\sigma}_{\max}$, where σ'_{ij} are the deviatoric stress components, and $\bar{\sigma}_{\max}$ is the equivalent stress at failure
 - f) $\varepsilon_1 \geq \varepsilon_{\max}$, where ε_1 is the maximum principal strain, and ε_{\max} is the maximum principal strain at failure
 - g) $\gamma_1 \geq \gamma_{\max}/2$, where γ_1 is the maximum tensorial shear strain = $(\varepsilon_1 - \varepsilon_3)/2$, and γ_{\max} is the engineering shear strain at failure
 - h) The Tuler-Butcher criterion,

$$\int_0^t [\max(0, \sigma_1 - \sigma_0)]^2 dt \geq K_f ,$$

where σ_1 is the maximum principal stress, σ_0 is a specified threshold stress, $\sigma_1 \geq \sigma_0 \geq 0$, and K_f is the stress impulse for failure. Stress values below the threshold value are too low to cause fracture even for very long duration loadings.

- i) A nonlocal failure criterion which is mainly intended for windshield impact can be defined using ENGCRT, RADCRT, and one additional “main” failure criterion (only SIGP1 is available at the moment). All three parameters should be defined for one part, namely the windshield glass and the glass should be discretized with shell elements. The course of events of this nonlocal failure model is as follows: If the main failure criterion SIGP1 is fulfilled, the corresponding element is flagged as center of impact, but no element erosion takes place yet. Then, the internal energy of shells inside a circle, defined by RADCRT, around the center of impact is tested against the product of the given critical energy ENGCRT and the “area factor”. The area factor is defined as,

$$\text{Area Factor} = \frac{\text{total area of shell elements found inside the circle}}{2\pi \times \text{RADCRT}^2}$$

The reason for having two times the circle area in the denominator is that we expect two layers of shell elements, as would typically be the case for laminated windshield glass. If this energy criterion is exceeded, all elements of the part are now allowed to be eroded by the main failure criterion.

- j) An element size dependent mixed-mode fracture criterion (MMFC) can be defined for shell elements using load curves LCEPS12, LCEPS23, and LCEPSMX. Failure happens if NCS (see Card 1) of these three criteria are met

$$\begin{aligned} \text{LCEPS12: } \gamma_{12} &= \frac{1}{2}(\varepsilon_1 - \varepsilon_2) \geq \gamma_{12}^c(l_e) & \text{if } -2.0 \leq \varepsilon_2/\varepsilon_1 \leq -0.5 \\ \text{LCEPS13: } \gamma_{13} &= \frac{1}{2}(\varepsilon_1 - \varepsilon_3) \geq \gamma_{13}^c(l_e) & \text{if } -0.5 \leq \varepsilon_2/\varepsilon_1 \leq 1.0 \\ \text{LCEPSMX: } & \varepsilon_1 \geq \varepsilon_1^c(l_e) & \text{if } -0.5 \leq \varepsilon_2/\varepsilon_1 \leq 1.0 \end{aligned}$$

where γ_{12} and γ_{13} are in-plane and through-thickness shear strains, ε_1 and ε_2 are in-plane major and minor strains, and ε_3 is the through-thickness strain. The characteristic element size is l_e and it is computed as the square root of the shell element area. More details can be found in Zhu & Zhu (2011).

2. **NUMFIP.** Element erosion depends on the type of element and the value of NUMFIP.

- a) When NUMFIP > 0, elements erode when NUMFIP points fail.

- b) For shells only, when $-100 \leq \text{NUMFIP} < 0$, elements erode when $|\text{NUMFIP}|$ percent of the integration points fail.
- c) For shells only, when $\text{NUMFIP} < -100$, elements erode when $|\text{NUMFIP}| - 100$ integration points fail.

For $\text{NUMFIP} > 0$ and $-100 \leq \text{NUMFIP} < 0$, layers retain full strength until the element is eroded. For $\text{NUMFIP} < -100$, the stress at an integration point immediately drops to zero when failure is detected at that integration point.

3. **Instability.** If the keyword `*DEFINE_MATERIAL_HISTORIES` is used to output the instability, the following table gives a summary of the output properties. Currently only failure values based on the first two cards of this keyword are supported but others can be added on request; for the unsupported options the output will be zero. The instability value is defined as the quantity of interest divided by its corresponding upper limit (restricted to be positive).

<i>*DEFINE_MATERIAL_HISTORIES Properties</i>		
Label	Attributes	Description
Instability	- - - -	Maximum of the ones listed below
Instability	-1 - - -	P/MXPRES
Instability	-2 - - -	ϵ_3/MNEPS
Instability	-3 - - -	ϵ_p/EFFEPS
Instability	-4 - - -	$\epsilon_{\text{vol}}/\text{VOLEPS}$
Instability	-5 - - -	P/MNPRES
Instability	-6 - - -	$\sigma_1/\text{SIGP1}$
Instability	-7 - - -	$\sqrt{\frac{3}{2} \sigma'_{ij} \sigma'_{ij}}/\text{SIGVM}$
Instability	-8 - - -	ϵ_1/MXEPS
Instability	-9 - - -	γ_1/EPSSH
Instability	-10 - - -	$\int_0^t [\max(0, \sigma_1 - \sigma_0)]^2 dt / \text{IMPULSE}$
Instability	-12 - - -	t/FAILTM

4. **VOLFRAC.** The volumes associated with individual integration points in higher order finite elements and isogeometric elements varies widely. Thus, the number of failed integration points is not a reliable criterion for determining element failure. To obtain a more stable and consistent response, LS-DYNA uses the volume fraction of the failed material for these types of elements.

***MAT_ADD_FATIGUE_{OPTION}**

Available options include:

<BLANK>

EN

The ADD_FATIGUE option defines the S-N or the E-N (with option EN) fatigue property of a material model.

Card Summary:

Card 1a. This card is included if and only if no keyword option (<BLANK>) is used and LCID > 0.

MID	LCID	LTYPE				SNLIMT	SNTYPE
-----	------	-------	--	--	--	--------	--------

Card 1b. This card is included if and only if no keyword option (<BLANK>) is used and LCID < 0.

MID	LCID	LTYPE	A	B	STHRES	SNLIMT	SNTYPE
-----	------	-------	---	---	--------	--------	--------

Card 1c. This card is included if and only if the keyword option EN is used.

MID	KP	NP	SIGMAF	EPSP	BP	CP	
-----	----	----	--------	------	----	----	--

Card 2a. This card is read if no keyword option (<BLANK>) is used and LCID < 0. Include one card for each additional S-N curve segment. Between zero and seven of these cards may be included in the deck. This input ends at the next keyword ("*") card.

			A_i	B_i	$STHRES_i$		
--	--	--	-------	-------	------------	--	--

Card 2b. This card is read if the keyword option EN is used. Card 2b is not needed if E and PR have been defined in the original material card.

E	PR						
---	----	--	--	--	--	--	--

Data Card Definitions:

Card 1a	1	2	3	4	5	6	7	8
Variable	MID	LCID	LTYPE				SNLIMT	SNTYPE
Type	A	I	I				I	I
Default	none	-1	0				0	0

VARIABLE**DESCRIPTION**

MID	Material ID for which the fatigue property applies
LCID	S-N fatigue curve ID: GT.0: S-N fatigue curve ID
LTYPE	Type of S-N curve: EQ.0: Semi-log interpolation (default) EQ.1: Log-log interpolation EQ.2: Linear-linear interpolation
SNLIMT	SNLIMT determines the algorithm used when stress is lower than the lowest stress on S-N curve. EQ.0: Use the life at the last point on S-N curve EQ.1: Extrapolation from the last two points on S-N curve EQ.2: Infinity
SNTYPE	Stress type of S-N curve: EQ.0: Stress range (default) EQ.1: Stress amplitude

Card 1b	1	2	3	4	5	6	7	8
Variable	MID	LCID	LTYPE	A	B	STHRES	SNLIMIT	SNTYPE
Type	I	I	I	F	F	F	I	I
Default	none	-1	0	0.0	0.0	none	0	0

VARIABLE**DESCRIPTION**

MID	Material ID for which the fatigue property applies
LCID	S-N fatigue curve ID: EQ.-1: S-N fatigue curve uses equation $NS^b = a$ EQ.-2: S-N fatigue curve uses equation $\log(S) = a - b \log(N)$ EQ.-3: S-N fatigue curve uses equation $S = a N^b$ EQ.-4: S-N fatigue curve uses equation $S = a - b \log(N)$
LTYPE	Type of S-N curve: EQ.0: Semi-log interpolation (default) EQ.1: Log-log interpolation EQ.2: Linear-linear interpolation
A	Material parameter a in S-N fatigue equation
B	Material parameter b in S-N fatigue equation
STHRES	Fatigue threshold stress
SNLIMIT	SNLIMIT determines the algorithm used when stress is lower than STHRES. EQ.0: Use the life at STHRES EQ.1: Ignored EQ.2: Infinity
SNTYPE	Stress type of S-N curve. EQ.0: Stress range (default) EQ.1: Stress amplitude

Card 1c	1	2	3	4	5	6	7	8
Variable	MID	KP	NP	SIGMAF	EPSP	BP	CP	
Type	I	F	F	F	F	F	F	
Default	none	none	none	none	none	none	none	

VARIABLE

DESCRIPTION

MID	Material identification for which the fatigue property applies
KP	K' , the cyclic strength coefficient
NP	N' , the cyclic strain hardening exponent
SIGMAF	σ'_f , the fatigue strength coefficient
EPSP	ϵ'_f , the fatigue ductility coefficient
BP	b' , the fatigue strength exponent (Basquin's exponent)
CP	c' , the fatigue ductility exponent (Coffin-Manson exponent)

S-N Curve Segment Cards. Include one card for each additional S-N curve segment. Between zero and seven of these cards may be included in the deck. This input ends at the next keyword ("*") card.

Card 2a	1	2	3	4	5	6	7	8
Variable				A_i	B_i	STHRES $_i$		
Type				F	F	F		
Default				0.0	0.0	none		

VARIABLE

DESCRIPTION

A_i	Material parameter a in S-N fatigue equation for the i^{th} segment
B_i	Material parameter b in S-N fatigue equation for the i^{th} segment

VARIABLE	DESCRIPTION							
----------	-------------	--	--	--	--	--	--	--

STHRES*i* Fatigue threshold stress for the *i*th segment which acts as the lower stress limit of that segment

Card 2b	1	2	3	4	5	6	7	8
Variable	E	PR						
Type	I	F						
Default	none	none						

VARIABLE	DESCRIPTION							
----------	-------------	--	--	--	--	--	--	--

E Young's modulus

PR Poisson's ratio

Remarks:

1. **S-N Curves.** For fatigue analysis based on stress (OPTION = <BLANK>), S-N curves can be defined by *DEFINE_CURVE or by a predefined equation. When they are defined by curves, the abscissa values (the first column under *DEFINE_CURVE) represent N (number of cycles to failure) and the ordinate values (2nd column under *DEFINE_CURVE) represent S (stress). There are 4 different predefined equations:

a) *LCID* = -1:

$$NS^b = a$$

b) *LCID* = -2:

$$\log(S) = a - b \log(N)$$

c) *LCID* = -3:

$$S = a N^b$$

d) *LCID* = -4:

$$S = a - b \log(N)$$

Here *N* is the number of cycles for fatigue failure and *S* is the stress amplitude. Note that the two equations can be converted to each other, with some minor algebraic manipulation on the constants *a* and *b*.

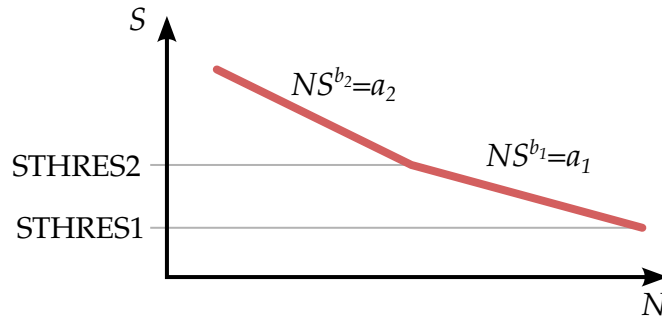

Figure 2-4. S-N Curve having multiple slopes

To define an S-N curve with multiple slopes, the S-N curve can be split into multiple segments with each segment defined by a set of parameters A_i , B_i and $STHRES_i$. Up to 8 sets of the parameters (A_i , B_i and $STHRES_i$) can be defined. The lower limit of the i^{th} segment is represented by the threshold stress $STHRES_i$, as shown in [Figure 2-4](#). This only applies to the case where $LCID < 0$.

2. **Related Keywords.** This model is applicable to frequency domain fatigue analysis, defined by the keywords: *FREQUENCY_DOMAIN_RANDOM_VIBRATION_FATIGUE and *FREQUENCY_DOMAIN_SSD_FATIGUE. It also applies to time domain fatigue analysis, defined by the keyword *FATIGUE (see these keywords for further details).
3. **Strain-Based Fatigue.** For fatigue analysis based on strain ($OPTION = EN$), the cyclic stress-strain curve is defined by

$$\varepsilon = \frac{\sigma}{E} + \left(\frac{\sigma}{K'}\right)^{\frac{1}{n'}}$$

The relationship between true local strain amplitude and endurance is

$$\frac{\Delta\varepsilon}{2} = \frac{\sigma'_f}{E} (2N)^{b'} + \varepsilon'_f (2N)^{c'}$$

***MAT_ADD_GENERALIZED_DAMAGE**

This option provides a way of including generalized (tensor type) damage and failure in standard LS-DYNA material models. The basic idea is to apply a general damage model (e.g. GISSMO) using several history variables as damage driving quantities at the same time. With this feature it may be possible to obtain, for example, anisotropic damage behavior or separate stress degradation for volumetric and deviatoric deformations. A maximum of three simultaneous damage evolutions (meaning definition of 3 history variables) is possible. A detailed description of this model can be found in Erhart et al. [2017].

This option currently applies to shell element types 1, 2, 3, 4, 16, and 17 and solid element types -2, -1, 1, 2, 3, 4, 10, 13, 15, 16, and 17.

Card Summary:

Card 1. This card is required.

MID	IDAM	DTYP	REFSZ	NUMFIP		PDDT	NHIS
-----	------	------	-------	--------	--	------	------

Card 2. This card is required.

HIS1	HIS2	HIS3	IFLG1	IFLG2	IFLG3	IFLG4	
------	------	------	-------	-------	-------	-------	--

Card 3. This card is required.

D11	D22	D33	D44	D55	D66		
-----	-----	-----	-----	-----	-----	--	--

Card 4a. This card is included for shell elements

D12	D21	D24	D42	D14	D41		
-----	-----	-----	-----	-----	-----	--	--

Card 4b. This card is included for solid elements.

D12	D21	D23	D32	D13	D31		
-----	-----	-----	-----	-----	-----	--	--

Card 5.1. NHIS sets of Cards 5.1 and 5.2 (total of $2 \times$ NHIS cards) must be defined for each history variable (HIS_n).

LCSDG	ECRIT	DMGEXP	DCRIT	FADEXP	LCREG		
-------	-------	--------	-------	--------	-------	--	--

Card 5.2. NHIS sets of Cards 5.1 and 5.2 (total of $2 \times$ NHIS cards) must be defined for each history variable (HIS_n).

LCSRS	SHRF	BIAXF	LCDLIM	MIDFAIL	NFLOC		
-------	------	-------	--------	---------	-------	--	--

Data Card Definitions:

Card 1	1	2	3	4	5	6	7	8
Variable	MID	IDAM	DTYP	REFSZ	NUMFIP		PDDT	NHIS
Type	A	I	I	F	F		I	I
Default	none	0	0	0.0	1.0		0	1

VARIABLE**DESCRIPTION**

MID	Material ID for which this generalized damage definition applies
IDAM	Flag for damage model: EQ.0: No damage model is used. EQ.1: GISSMO damage model
DTYP	Flag for damage behavior: EQ.0: Damage is accumulated; no coupling to flow stress, no failure. EQ.1: Damage is accumulated; element failure occurs for $D = 1$.
REFSZ	Reference element size, for which an additional output of damage will be generated. This is necessary to ensure the applicability of resulting damage quantities when transferred to different mesh sizes.
NUMFIP	Number of failed integration points prior to element deletion. The default is unity. LT.0: $ \text{NUMFIP} $ is the percentage of layers which must fail before the element fails.
PDDT	Pre-defined damage tensors. If non-zero, damage tensor coefficients D11 to D66 on Cards 3 and 4 will be ignored. See Remark 2 . EQ.0: No pre-defined damage tensor is used. EQ.1: Isotropic damage tensor EQ.2: 2-parameter isotropic damage tensor for volumetric-deviatoric split

VARIABLE	DESCRIPTION
----------	-------------

EQ.3: Anisotropic damage tensor as in MAT_104 (FLAG = -1)
 EQ.4: 3-parameter damage tensor associated with IFLG1 = 2

NHIS Number of history variables as driving quantities (min = 1, max = 3)

Card 2	1	2	3	4	5	6	7	8
Variable	HIS1	HIS2	HIS3	IFLG1	IFLG2	IFLG3	IFLG4	
Type	I	I	I	I	I	I	I	
Default	0	optional	optional	0	0	0	0	

VARIABLE	DESCRIPTION
----------	-------------

HIS n Choice of variable as driving quantity for damage, called “history value” in the following:

EQ.0: Equivalent plastic strain rate is the driving quantity for the damage if IFLG1 = 0. Alternatively, if IFLG1 = 1, components of the plastic strain rate tensor are driving quantities for damage (see [Remarks 2](#) and [3](#)).

GT.0: The rate of the additional history variable HIS n is the driving quantity for damage. IFLG1 should be set to 0.

LT.0: *DEFINE_FUNCTION IDs defining the damage driving quantities as a function of the components of the plastic strain rate tensor; IFLG1 should be set to 1.

IFLG1 Damage driving quantities:

EQ.0: Rates of history variables HIS n

EQ.1: Specific components of the plastic strain rate tensor; see [Remarks 2](#) and [3](#).

EQ.2: Predefined functions of plastic strain rate components for orthotropic damage model. HIS n inputs will be ignored, and IFLG2 should be set to 1. This option is for shell elements only.

VARIABLE**DESCRIPTION**

	EQ.3: Specific components of the total strain rate tensor; see Remarks 2 and 3 .
IFLG2	<p>Damage strain coordinate system:</p> <p>EQ.0: Local element system (shells) or global system (solids)</p> <p>EQ.1: Material system, only applicable for non-isotropic material models. Supported models for shell elements: all materials with AOPT feature. Supported models for solid elements: 22, 33, 41-50, 58, 103, 122, 133, 157, 199, 233.</p> <p>EQ.2: Principal strain system (rotating)</p> <p>EQ.3: Principal strain system (fixed when instability/coupling starts)</p>
IFLG3	<p>Erosion criteria and damage coupling system:</p> <p>EQ.0: Erosion occurs when one of the damage parameters computed reaches unity; the damage tensor components are based on the individual damage parameters d_1 to d_3.</p> <p>EQ.1: Erosion occurs when a single damage parameter D reaches unity; the damage tensor components are based on this single damage parameter.</p>
IFLG4	<p>Damage drivers' evolution flag. This option is relevant for cyclic loading when IFLG1 is set to 1 or 3. Damage cannot increase with decreasing strain or history variable, but as soon as the strain/history increase again after unloading (i.e., below the previously reached maximum), the damage also increases again (behavior with IFLG4 = 0). This can be prevented with IFLG4 = 1, where the last maximum strain/history is saved.</p>

Card 3	1	2	3	4	5	6	7	8
Variable	D11	D22	D33	D44	D55	D66		
Type	I	I	I	I	I	I		

Damage for Shell Elements Card. This card is included for shell elements.

Card 4a	1	2	3	4	5	6	7	8
Variable	D12	D21	D24	D42	D14	D41		
Type	I	I	I	I	I	I		

Damage for Solid Elements. This card is included for solid elements.

Card 4b	1	2	3	4	5	6	7	8
Variable	D12	D21	D23	D32	D13	D31		
Type	I	I	I	I	I	I		

VARIABLE

DESCRIPTION

D_{ij}

DEFINE_FUNCTION IDs for damage tensor coefficients; see [Remark 2](#).

Damage Definition Cards for IDAM = 1 (GISSMO). NHIS sets of Cards 5.1 and 5.2 (total of 2 × NHIS cards) must be defined for each history variable (HIS_n).

Card 5.1	1	2	3	4	5	6	7	8
Variable	LCSDG	ECRIT	DMGEXP	DCRIT	FADEXP	LCREG		
Type	I	F	F	F	F	I		
Default	0	0.0	1.0	0.0	1.0	0		

VARIABLE

DESCRIPTION

LCSDG

Load curve ID defining corresponding history value to failure as a function of triaxiality.

ECRIT

Critical history value (material instability):

LT.0.0: |ECRIT| is load curve ID defining critical history value as a function of triaxiality.

VARIABLE	DESCRIPTION
	EQ.0.0: Fixed value DCRIT defining critical damage is read. GT.0.0: Fixed value for stress-state independent critical history value
DMGEXP	Exponent for nonlinear damage accumulation
DCRIT	Damage threshold value (critical damage). If a load curve of critical history value or fixed value is given by ECRIT, input is ignored.
FADEXP	Exponent for damage-related stress fadeout. LT.0.0: FADEXP is load curve ID defining element-size dependent fading exponent GT.0.0: Constant fading exponent
LCREG	Load curve ID defining element size dependent regularization factors for history value to failure

Damage Definition Cards for IDAM = 1 (GISSMO). NHIS sets of Cards 5.1 and 5.2 (total of $2 \times$ NHIS cards) must be defined for each history variable (HIS_n).

Card 5.2	1	2	3	4	5	6	7	8
Variable	LCSRS	SHRF	BIAXF	LCDLIM	MIDFAIL	NFLOC		
Type	I	F	F	I	F	F		
Default	0	0.0	0.0	0	0.0	0.0		

VARIABLE	DESCRIPTION
LCSRS	Load curve ID defining failure history value scaling factor for LCS-DG as a function of history value rate. If the first rate value in the curve is negative, it is assumed that all rate values are given as natural logarithm of the history rate. GT.0: Scale ECRIT as well. LT.0: Do not scale ECRIT.
SHRF	Reduction factors for regularization at triaxiality = 0 (shear)
BIAXF	Reduction factors for regularization at triaxiality = 2/3 (biaxial)

VARIABLE	DESCRIPTION
LCDLIM	Load curve ID defining damage limit values as a function of triaxiality. Damage can be restricted to values less than 1.0 to prevent further stress reduction and failure for certain triaxialities.
MIDFAIL	Mid-plane failure option for shell elements. If active, then critical strain is only checked at the mid-plane integration point, meaning an odd number for NIP should be used. Damage is computed at the other integration points, but no coupling to the stresses is done first. As soon as the mid-plane IP reaches ECRIT/DCRIT, then all the other IPs are also checked (exception: MIDFAIL = 4). EQ.0.0: Inactive EQ.1.0: Active. The stresses immediately begin to reduce for non-mid-plane IPs that are already above their critical value. Coupling only occurs for IPs that reach their criterion. EQ.2.0: Active. The stresses immediately begin to reduce for all the non-mid-plane IPs. NUMFIP is active. EQ.3.0: Active. Same as 2, but when $D = 1$ is reached in the middle integration point, the element is eroded instantaneously. NUMFIP is disregarded. EQ.4.0: Active. Damage and failure is applied only on the mid-point. When $D = 1$ on the midpoint, the element is eroded. NUMFIP is disregarded. Integration points away from the midplane see no stress reduction and no failure.
NFLOC	Optional "local" number of failed integration points prior to element deletion. Overwrites the definition of NUMFIP for history variable HIS_n .

Remarks:

1. **Comparison to GISSMO Damage Model.** The GISSMO damage model is described in detail in the remarks of *MAT_ADD_DAMAGE_GISSMO. If $NHIS = 1$ and $HIS1 = 0$ is used, this keyword behaves the same as GISSMO. The main difference between this keyword and GISSMO is that up to 3 independent but simultaneous damage evolutions are possible. Therefore, parameters LCS-DG, ECRIT, DMGEXP, DCRIT, FADEXP, LCREGD, LCSRS, SHRF, BIAXF, and LCDLIM can be defined separately for each history variable.

2. **Damage Tensor.** The relation between nominal (damaged) stresses σ_{ij} and effective (undamaged) stresses $\tilde{\sigma}_{ij}$ is now expressed as

$$\begin{bmatrix} \sigma_{11} \\ \sigma_{22} \\ \sigma_{33} \\ \sigma_{12} \\ \sigma_{23} \\ \sigma_{31} \end{bmatrix} = \begin{bmatrix} D_{11} & D_{12} & D_{13} & 0 & 0 & 0 \\ D_{21} & D_{22} & D_{23} & 0 & 0 & 0 \\ D_{31} & D_{32} & D_{33} & 0 & 0 & 0 \\ 0 & 0 & 0 & D_{44} & 0 & 0 \\ 0 & 0 & 0 & 0 & D_{55} & 0 \\ 0 & 0 & 0 & 0 & 0 & D_{66} \end{bmatrix} \begin{bmatrix} \tilde{\sigma}_{11} \\ \tilde{\sigma}_{22} \\ \tilde{\sigma}_{33} \\ \tilde{\sigma}_{12} \\ \tilde{\sigma}_{23} \\ \tilde{\sigma}_{31} \end{bmatrix}$$

with damage tensor **D**. Each damage tensor coefficient D_{ij} can be defined using *DEFINE_FUNCTION as a function of damage parameters d_1 to d_3 . For simple isotropic damage driven by plastic strain (NHIS = 1, HIS1 = 0, IFLG1 = IFLG2 = IFLG3 = 0) that would be

$$\begin{bmatrix} \sigma_{11} \\ \sigma_{22} \\ \sigma_{33} \\ \sigma_{12} \\ \sigma_{23} \\ \sigma_{31} \end{bmatrix} = (1 - d_1) \begin{bmatrix} 1 & 0 & 0 & 0 & 0 & 0 \\ 0 & 1 & 0 & 0 & 0 & 0 \\ 0 & 0 & 1 & 0 & 0 & 0 \\ 0 & 0 & 0 & 1 & 0 & 0 \\ 0 & 0 & 0 & 0 & 1 & 0 \\ 0 & 0 & 0 & 0 & 0 & 1 \end{bmatrix} \begin{bmatrix} \tilde{\sigma}_{11} \\ \tilde{\sigma}_{22} \\ \tilde{\sigma}_{33} \\ \tilde{\sigma}_{12} \\ \tilde{\sigma}_{23} \\ \tilde{\sigma}_{31} \end{bmatrix}$$

That means the following function should be defined for D11 to D66 (Card 3):

```
*DEFINE_FUNCTION
1,D11toD66
func1 (d1, d2, d3) = (1.0 - d1)
```

and all entries in Card 4 can be left empty or equal to zero in that case.

If GISSMO (IDAM = 1) is used, the damage parameters used in those functions are internally replaced by

$$d_i \rightarrow \left(\frac{d_i - DCRIT_i}{1 - DCRIT_i} \right)^{FADEXP_i}$$

In the case of plane stress (shell) elements, coupling between normal stresses and shear stresses is implemented and the damage tensor is defined as below:

$$\begin{bmatrix} \sigma_{11} \\ \sigma_{22} \\ 0 \\ \sigma_{12} \\ \sigma_{23} \\ \sigma_{31} \end{bmatrix} = \begin{bmatrix} D_{11} & D_{12} & 0 & D_{14} & 0 & 0 \\ D_{21} & D_{22} & 0 & D_{24} & 0 & 0 \\ 0 & 0 & D_{33} & 0 & 0 & 0 \\ D_{41} & D_{42} & 0 & D_{44} & 0 & 0 \\ 0 & 0 & 0 & 0 & D_{55} & 0 \\ 0 & 0 & 0 & 0 & 0 & D_{66} \end{bmatrix} \begin{bmatrix} \tilde{\sigma}_{11} \\ \tilde{\sigma}_{22} \\ 0 \\ \tilde{\sigma}_{12} \\ \tilde{\sigma}_{23} \\ \tilde{\sigma}_{31} \end{bmatrix}$$

Since the evaluation of *DEFINE_FUNCTION for variables D11 to D66 is relatively time consuming, pre-defined damage tensors (PDDT) can be used. Currently the following options are available for shell elements:

PDDT	Damage Tensor
1	$(1 - D_1) \begin{bmatrix} 1 & 0 & 0 & 0 & 0 & 0 \\ 0 & 1 & 0 & 0 & 0 & 0 \\ 0 & 0 & 1 & 0 & 0 & 0 \\ 0 & 0 & 0 & 1 & 0 & 0 \\ 0 & 0 & 0 & 0 & 1 & 0 \\ 0 & 0 & 0 & 0 & 0 & 1 \end{bmatrix}$
2	$\begin{bmatrix} 1 - \frac{2}{3}D_1 - \frac{1}{3}D_2 & \frac{1}{3}D_1 - \frac{1}{3}D_2 & 0 & 0 & 0 & 0 \\ \frac{1}{3}D_1 - \frac{1}{3}D_2 & 1 - \frac{2}{3}D_1 - \frac{1}{3}D_2 & 0 & 0 & 0 & 0 \\ 0 & 0 & 1 & 0 & 0 & 0 \\ 0 & 0 & 0 & 1 - D_1 & 0 & 0 \\ 0 & 0 & 0 & 0 & 1 & 0 \\ 0 & 0 & 0 & 0 & 0 & 1 \end{bmatrix}$
3	$\begin{bmatrix} 1 - D_1 & 0 & 0 & 0 & 0 & 0 \\ 0 & 1 - D_2 & 0 & 0 & 0 & 0 \\ 0 & 0 & 1 & 0 & 0 & 0 \\ 0 & 0 & 0 & 1 - \frac{1}{2}(D_1 + D_2) & 0 & 0 \\ 0 & 0 & 0 & 0 & 1 - \frac{1}{2}D_2 & 0 \\ 0 & 0 & 0 & 0 & 0 & 1 - \frac{1}{2}D_1 \end{bmatrix}$
4	$\begin{bmatrix} 1 - D_1 & 0 & 0 & 0 & 0 & 0 \\ 0 & 1 - D_2 & 0 & 0 & 0 & 0 \\ 0 & 0 & 1 - D_3 & 0 & 0 & 0 \\ 0 & 0 & 0 & 1 & 0 & 0 \\ 0 & 0 & 0 & 0 & 1 & 0 \\ 0 & 0 & 0 & 0 & 0 & 1 \end{bmatrix}$

and the following ones for solid elements:

PDD T	Damage Tensor
1	$(1 - D_1) \begin{bmatrix} 1 & 0 & 0 & 0 & 0 & 0 \\ 0 & 1 & 0 & 0 & 0 & 0 \\ 0 & 0 & 1 & 0 & 0 & 0 \\ 0 & 0 & 0 & 1 & 0 & 0 \\ 0 & 0 & 0 & 0 & 1 & 0 \\ 0 & 0 & 0 & 0 & 0 & 1 \end{bmatrix}$
2	$\begin{bmatrix} 1 - \frac{2}{3}D_1 - \frac{1}{3}D_2 & \frac{1}{3}D_1 - \frac{1}{3}D_2 & \frac{1}{3}D_1 - \frac{1}{3}D_2 & 0 & 0 & 0 \\ \frac{1}{3}D_1 - \frac{1}{3}D_2 & 1 - \frac{2}{3}D_1 - \frac{1}{3}D_2 & \frac{1}{3}D_1 - \frac{1}{3}D_2 & 0 & 0 & 0 \\ \frac{1}{3}D_1 - \frac{1}{3}D_2 & \frac{1}{3}D_1 - \frac{1}{3}D_2 & 1 - \frac{2}{3}D_1 - \frac{1}{3}D_2 & 0 & 0 & 0 \\ 0 & 0 & 0 & 1 - D_1 & 0 & 0 \\ 0 & 0 & 0 & 0 & 1 - D_1 & 0 \\ 0 & 0 & 0 & 0 & 0 & 1 - D_1 \end{bmatrix}$
3	$\begin{bmatrix} 1 - D_1 & 0 & 0 & 0 & 0 & 0 \\ 0 & 1 - D_2 & 0 & 0 & 0 & 0 \\ 0 & 0 & 1 - D_3 & 0 & 0 & 0 \\ 0 & 0 & 0 & 1 - \frac{1}{2}(D_1 + D_2) & 0 & 0 \\ 0 & 0 & 0 & 0 & 1 - \frac{1}{2}(D_2 + D_3) & 0 \\ 0 & 0 & 0 & 0 & 0 & 1 - \frac{1}{2}(D_3 + D_1) \end{bmatrix}$

- History Variables.** The increment of the damage parameter is computed in GISSMO based on a driving quantity that has the dimension of a strain rate:

$$\dot{d} = nd^{1-1/n} \frac{HIS_i}{epf}$$

The history variables defined by the user through HIS_i should thus have the dimension of a strain as the rate is computed internally by MAT_ADD_GENERALIZED_DAMAGE:

$$HIS_i = \frac{HIS_i(t^{n+1}) - HIS_i(t^n)}{t^{n+1} - t^n}$$

History variables can either come directly from associated material models (IFLG1 = 0 and HIS_i > 0), or they can be equivalent to plastic strain rate tensor components (IFLG1 = 1 and HIS_i = 0):

$$\begin{aligned} \dot{HIS}_1 &= \dot{\epsilon}_{xx}^p, & \dot{HIS}_2 &= \dot{\epsilon}_{yy}^p, & \dot{HIS}_3 &= \dot{\epsilon}_{xy}^p & \text{for IFLG2} &= 0 \\ \dot{HIS}_1 &= \dot{\epsilon}_{aa}^p, & \dot{HIS}_2 &= \dot{\epsilon}_{bb}^p, & \dot{HIS}_3 &= \dot{\epsilon}_{ab}^p & \text{for IFLG2} &= 1 \\ \dot{HIS}_1 &= \dot{\epsilon}_1^p, & \dot{HIS}_2 &= \dot{\epsilon}_2^p, & \dot{HIS}_3 &= 0 & \text{for IFLG2} &= 2 \end{aligned}$$

or they can be provided via *DEFINE_FUNCTIONS by the user (IFLG1 = 1 and HISi < 0):

$$\begin{aligned} \dot{HIS}_i &= f_i(\dot{\epsilon}_{xx}^p, \dot{\epsilon}_{yy}^p, \dot{\epsilon}_{zz}^p, \dot{\epsilon}_{xy}^p, \dot{\epsilon}_{yz}^p, \dot{\epsilon}_{zx}^p) & \text{for IFLG2} &= 0 \\ \dot{HIS}_i &= f_i(\dot{\epsilon}_{aa}^p, \dot{\epsilon}_{bb}^p, \dot{\epsilon}_{zz}^p, \dot{\epsilon}_{ab}^p, \dot{\epsilon}_{bz}^p, \dot{\epsilon}_{za}^p) & \text{for IFLG2} &= 1 \\ \dot{HIS}_i &= f_i(\dot{\epsilon}_1^p, \dot{\epsilon}_2^p) & \text{for IFLG2} &= 2 \end{aligned}$$

The following example defines a history variable (HISi = -1234) as function of the transverse shear strains in material coordinate system (a, b, z) for shells:

```
*DEFINE_FUNCTION
1234
fhis1(eaa, ebb, ezz, eab, ebz, eza) = 1.1547*sqrt(ebz**2 + eza**2)
```

The plastic strain rate tensor is not always available in the material law and is estimated as:

$$\dot{\epsilon}^p = \frac{\dot{\epsilon}_{eff}^p}{\dot{\epsilon}_{eff}} \left[\dot{\epsilon} - \frac{\dot{\epsilon}_{vol}}{3} \delta \right]$$

This is a good approximation for isochoric materials with small elastic strains (such as metals) and correct for J2 plasticity.

You can also use the *total* strain rate components $\dot{\epsilon}_{ij}$ instead of the *plastic* strain rate components $\dot{\epsilon}_{ij}^p$ by changing IFLG1 = 1 to IFLG1 = 3. Setting IFLG4 = 1 should be considered in that case (see description for IFLG4).

The following table gives an overview of the driving quantities used for incrementing the damage in function of the input parameters (strain superscript “p” for “plastic” is omitted for convenience):

IFLG1	IFLG2	HISi > 0	HISi = 0	HISi < 0
0	0	\dot{HIS}_i	$\dot{\epsilon}$	N/A
0	1	\dot{HIS}_i	N/A	N/A
0	2	\dot{HIS}_i	N/A	N/A
1/3	0	N/A	$\dot{\epsilon}_{ij}$	$f(\dot{\epsilon}_{ij})$
1/3	1	N/A	$\dot{\epsilon}_{ij}^{mat}$	$f(\dot{\epsilon}_{ij}^{mat})$

IFLG1	IFLG2	HIS _i > 0	HIS _i = 0	HIS _i < 0
1/3	2	N/A	$\dot{\epsilon}_i$	$f(\dot{\epsilon}_i)$
2	0	N/A		
2	1	Preprogrammed functions of plastic strain rate		
2	2	N/A		

4. **Post-Processing History Variables.** History variables of the GENERALIZED_DAMAGE model are written to the post-processing database behind those already occupied by the material model which is used in combination:

History Variable #	Description
ND	Triaxiality variable σ_H/σ_M
ND + 1	Lode parameter value
ND + 2	Single damage parameter D , ($10^{-20} < D \leq 1$), only for IFLG3 = 1
ND + 3	Damage parameter d_1
ND + 4	Damage parameter d_2
ND + 5	Damage parameter d_3
ND + 6	Damage threshold DCRIT ₁
ND + 7	Damage threshold DCRIT ₂
ND + 8	Damage threshold DCRIT ₃
ND + 12	History variable HIS ₁
ND + 13	History variable HIS ₂
ND + 14	History variable HIS ₃
ND + 15	Angle between principal and material axes
ND + 21	Characteristic element size (used in LCREG)

For instance, ND = 6 for *MAT_024, ND = 9 for *MAT_036, and ND = 23 for *MAT_187. Exact information of the variable locations can be found in the d3hsp section "MAGD damage history listing."

*MAT_ADD_INELASTICITY

The purpose of this card is to add inelasticity features to an arbitrary standard material model. It may either be used as a modular concept on top of a simple elastic model or patching a more complex material model with a missing inelastic feature.

This keyword is under development and currently only applies to shell types 2, 4 and 16, and solid types -18, -2, -1, 1, 2, 10, 15, 16 and 17. Implicit as well as explicit analyses are supported, and the user should be aware of an extra cost associated with using this feature.

Card Summary:

Card 1. This card is required. NIELINKS groups of Cards 4 through 6 should follow this card, possibly after input of anisotropy information in Cards 2 and 3.

MID	NIELINKS		G	K	AOPT	MACF	BETA
-----	----------	--	---	---	------	------	------

Card 2. For AOPT > 0, define Cards 2 and 3.

XP	YP	ZP	A1	A2	A3		
----	----	----	----	----	----	--	--

Card 3. For AOPT > 0, define Cards 2 and 3.

V1	V2	V3	D1	D2	D3		
----	----	----	----	----	----	--	--

Card 4. For each link, Cards 4 through 6 are required. NIELAWS groups of Cards 5 and 6 should follow immediately after each Card 4.

NIELAWS	WEIGHT						
---------	--------	--	--	--	--	--	--

Card 5. NIELAWS sets of Cards 5 and 6 are required after each Card 4.

LAW	MODEL						
-----	-------	--	--	--	--	--	--

Card 6a. This card is required for LAW = 3 and MODEL = 1.

P1	P2						
----	----	--	--	--	--	--	--

Card 6b. This card is required for LAW = 3 and MODEL = 2.

P1							
----	--	--	--	--	--	--	--

Card 6c. This card is included for LAW = 5 and MODEL ≤ 2.

P1	P2	P3					
----	----	----	--	--	--	--	--

Card 6d. This card is required for LAW = 5 and MODEL = 3, and LAW = 6 and MODEL = 4.

P1	P2	P3	P4	P5	P6	P7	
----	----	----	----	----	----	----	--

Card 6e. This card is required for LAW = 5 and MODEL = 4, and LAW = 6 and MODEL = 5.

P1	P2	P3	P4				
----	----	----	----	--	--	--	--

Card 6f. This card is required for LAW = 6 and MODEL ≤ 3

P1	P2	P3	P4	P5	P6	P7	P8
----	----	----	----	----	----	----	----

Data Card Definitions:

Main Card. Only one instance of this card is needed. NIELINKS groups of Cards 4 through 6 should follow this card, possibly after input of anisotropy information in Cards 2 and 3.

Card 1	1	2	3	4	5	6	7	8
Variable	MID	NIELINKS		G	K	AOPT	MACF	BETA
Type	A	I		F	F	F	F	F
Default	none	1		0	0	0	0	0

VARIABLE

DESCRIPTION

MID	Material identification for which this inelasticity definition applies. A unique number or label must be specified (see *PART).
NIELINKS	Number of links/networks/phases specified by the user. An additional link may be added internally if the weights below do not sum up to unity.
G	Characteristic shear modulus used for some of the inelasticity models. This should reflect the elastic stiffness for the material without any inelasticity effects. For instance, if *MAT_ELASTIC is used, set $G = E/(2(1 + \nu))$.

VARIABLE	DESCRIPTION
K	Characteristic bulk modulus used for some of the inelasticity models. This should reflect the elastic stiffness for the material without any inelasticity effects. For instance, if *MAT_ELASTIC is used, set $K = E/(3(1 - 2\nu))$.
AOPT	<p>Material axes option (see *MAT_002 for a detailed description):</p> <p>EQ.0.0: Locally orthotropic with material axes determined by element nodes. For shells only, the material axes are then rotated about the normal vector to the surface of the shell by the angle BETA.</p> <p>EQ.1.0: Locally orthotropic with material axes determined by a point, P, in space and the global location of the element center. This option is for solid elements only.</p> <p>EQ.2.0: Globally orthotropic with material axes determined by vectors defined below</p> <p>EQ.3.0: Locally orthotropic material axes determined by a vector \mathbf{v} and the normal vector to the plane of the element. The plane of a solid element is the midsurface between the inner surface and outer surface defined by the first four nodes and the last four nodes of the connectivity of the element, respectively. Thus, for solid elements, AOPT = 3 is only available for hexahedrons. \mathbf{a} is determined by taking the cross product of \mathbf{v} with the normal vector, \mathbf{b} is determined by taking the cross product of the normal vector with \mathbf{a}, and \mathbf{c} is the normal vector. Then \mathbf{a} and \mathbf{b} are rotated about \mathbf{c} by an angle BETA. BETA may be set in the keyword input for the element or in the input for this keyword. Note that for solids, the material axes may be switched depending on the choice of MACF. The switch may occur before or after applying BETA depending on the value of MACF.</p> <p>EQ.4.0: Locally orthotropic in cylindrical coordinate system with the material axes determined by a vector, \mathbf{v}, and an originating point, P, defining the centerline axis. This option is for solid elements only.</p> <p>LT.0.0: The absolute value of AOPT is a coordinate system ID.</p>
MACF	<p>Material axes change flag for solid elements:</p> <p>EQ.-4: Switch material axes b and c before BETA rotation</p>

VARIABLE

DESCRIPTION

- EQ.-3: Switch material axes *a* and *c* before BETA rotation
- EQ.-2: Switch material axes *a* and *b* before BETA rotation
- EQ.1: No change, default
- EQ.2: Switch material axes *a* and *b* after BETA rotation
- EQ.3: Switch material axes *a* and *c* after BETA rotation
- EQ.4: Switch material axes *b* and *c* after BETA rotation

Figure M2-2 indicates when LS-DYNA applies MACF during the process to obtain the final material axes. If BETA on *ELEMENT_SOLID_{OPTION} is defined, then that BETA is used for the rotation for all AOPT options. Otherwise, if AOPT = 3, the BETA input on Card 3 rotates the axes. For all other values of AOPT, the material axes will be switched as specified by MACF, but no BETA rotation will be performed.

BETA Material angle in degrees for AOPT = 0 (shells only) and AOPT = 3 (all element types). This angle may be overridden on the element card; see *ELEMENT_SHELL_BETA and *ELEMENT_SOLID_ORTHO.

Anisotropy cards. Include Cards 2 and 3 if AOPT > 0.

Card 2	1	2	3	4	5	6	7	8
Variable	XP	YP	ZP	A1	A2	A3		
Type	F	F	F	F	F	F		
Default	0.0	0.0	0.0	0.0	0.0	0.0		

Card 3	1	2	3	4	5	6	7	8
Variable	V1	V2	V3	D1	D2	D3		
Type	F	F	F	F	F	F		
Default	0.0	0.0	0.0	0.0	0.0	0.0		

VARIABLE	DESCRIPTION
XP, YP, ZP	Coordinates of point, p , for AOPT = 1 and 4; see *MAT_002.
A1, A2, A3	Components of vector, \mathbf{a} , for AOPT = 2; see *MAT_002.
V1, V2, V3	Components of vector, \mathbf{v} , for AOPT = 3 and 4; see *MAT_002.
D1, D2, D3	Components of vector, \mathbf{d} , for AOPT = 2; see *MAT_002.

Link/network/phase Cards. Include NIELINKS sets of all cards that follow; NIELAWS groups of Cards 5 and 6 should follow immediately after each Card 4.

Card 4	1	2	3	4	5	6	7	8
Variable	NIELAWS	WEIGHT						
Type	I	F						
Default	none	0 or 1						

VARIABLE	DESCRIPTION
NIELAWS	Number of inelasticity laws that apply to this material model at this link, each contributing in its own way to the total inelastic strain (rate)
WEIGHT	Weight of this link/network/phase used when computing total stress.

Inelasticity model cards. Include NIELAWS sets of Cards 5 and 6; the Card 6 determined by the law and model selected should follow immediately after Card 5.

Card 5	1	2	3	4	5	6	7	8
Variable	LAW	MODEL						
Type	I	I						
Default	none	none						

VARIABLE	DESCRIPTION
----------	-------------

LAW	<p>Inelasticity law. One of the laws listed below must be chosen:</p> <p>EQ.3: Isotropic hardening plasticity</p> <p>EQ.5: Creep</p> <p>EQ.6: Viscoelasticity</p>
MODEL	<p>Model definition with choice dependent on the specified law above. A valid combination of law and model must be chosen.</p> <p>For isotropic hardening plasticity (LAW = 3), choices are</p> <p>EQ.1: Linear hardening</p> <p>EQ.2: Hardening from curve/table</p> <p>For creep (LAW = 5), choices are</p> <p>EQ.1: Norton incremental formulation</p> <p>EQ.2: Norton total formulation</p> <p>EQ.3: Norton-Bailey formulation</p> <p>EQ.4: Bergström-Boyce formulation</p> <p>For viscoelasticity (LAW = 6), choices are</p> <p>EQ.1: Bulk and shear decay, with optional temperature shifts, hypoelastic version</p> <p>EQ.2: Bulk and shear decay, with optional temperature shifts, hyperelastic version #1</p> <p>EQ.3: Bulk and shear decay, with optional temperature shifts, hyperelastic version #2</p> <p>EQ.4: Norton-Bailey formulation</p> <p>EQ.5: Bergström-Boyce formulation</p>

Inelasticity Parameters. This card is included for LAW = 3 and MODEL = 1.

Card 6a	1	2	3	4	5	6	7	8
Variable	P1	P2						
Type	F	F						
Default	0.0	0.0						

<u>VARIABLE</u>	<u>DESCRIPTION</u>
P1	Virgin yield stress, σ_0
P2	Hardening, H

Inelasticity Parameters. This card is included for LAW = 3 and MODEL = 2.

Card 6b	1	2	3	4	5	6	7	8
Variable	P1							
Type	I							
Default	0							

<u>VARIABLE</u>	<u>DESCRIPTION</u>
P1	Curve or table ID that defines the hardening

Inelasticity Parameters. This card is included for LAW = 5 and MODEL \leq 2.

Card 6c	1	2	3	4	5	6	7	8
Variable	P1	P2	P3					
Type	F	F	F					
Default	0.0	0.0	0.0					

<u>VARIABLE</u>	<u>DESCRIPTION</u>
P1	Norton creep parameter, A
P2	Norton creep parameter, m
P3	Norton creep parameter, n

Inelasticity Parameters. This card is included for LAW = 5 with MODEL = 3 and for LAW = 6 with MODEL = 4.

Card 6d	1	2	3	4	5	6	7	8
Variable	P1	P2	P3	P4	P5	P6	P7	
Type	F	F	F	F	F	F	F	
Default	0.0	0.0	0.0	0.0	0.0	0.0	0.0	

VARIABLE**DESCRIPTION**

P1	Norton-Bailey creep parameter, A
P2	Norton-Bailey creep parameter, σ_0
P3	Norton-Bailey creep parameter, n
P4	Norton-Bailey creep parameter, T_0
P5	Norton-Bailey creep parameter, p
P6	Norton-Bailey creep parameter, m
P7	Norton-Bailey creep parameter, ε_0

Inelasticity Parameters. This card is included for LAW = 5 with MODEL = 4 and for LAW = 6 with MODEL = 5.

Card 6e	1	2	3	4	5	6	7	8
Variable	P1	P2	P3	P4				
Type	F	F	F	F				
Default	0.0	0.0	0.0	0.0				

VARIABLE**DESCRIPTION**

P1	Bergström-Boyce creep parameter, A
P2	Bergström-Boyce creep parameter, m

VARIABLE	DESCRIPTION
P3	Bergström-Boyce creep parameter, C
P4	Bergström-Boyce creep parameter, E

Inelasticity Parameters. This card is included for LAW = 6 and MODEL = 1, 2, or 3.

Card 6f	1	2	3	4	5	6	7	8
Variable	P1	P2	P3	P4	P5	P6	P7	P8
Type	F	F	F	F	F	F	F	F
Default	0.0	0.0	0.0	0.0	0.0	0.0	0.0	0.0

VARIABLE	DESCRIPTION
P1	Shear decay coefficient, β_G
P2	Bulk decay coefficient, β_K
P3	Shear reference temperature, T_G
P4	Shear shift coefficient, A_G
P5	Shear shift coefficient, B_G
P6	Bulk reference temperature, T_K
P7	Bulk shift coefficient, A_K
P8	Bulk shift coefficient, B_K

Remarks:

General

The resulting stress from an integration point with inelasticities is the sum of the stress σ_I from each link, weighed by its weight, w_I (see WEIGHT above). A link in this context can also be referred to as a network or a phase, depending on the physical interpretation, and we use the subscript I to refer to a specific one. So, the stress, σ , is in the end given by

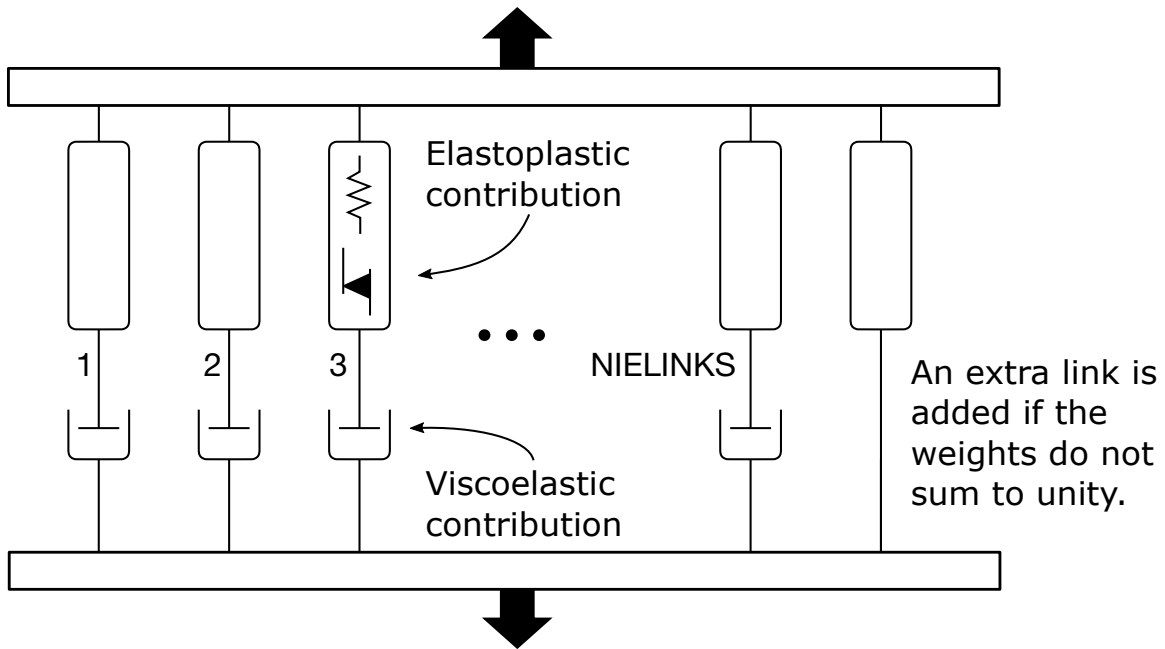

Figure 2-5. Schematic view of how inelasticity is added to the model.

$$\sigma = \sum_{I=1}^{NIELINKS(+1)} w_I \sigma_I .$$

The data for the links are specified by the user, except for a possible last one which is internally created if the weights do not sum to unity (whence the +1 in the number of terms in the sum above). This last link will get its stress $\sigma_{NIELINKS+1}$ only from the material model without any inelasticities, and its weight will be

$$w_{NIELINKS+1} = 1 - \sum_{I=1}^{NIELINKS} w_I ,$$

that is, just enough for the total weight to sum to 1. The stress for each link will be treated next, for which we drop the subscript I for the sake of clarity, and emphasize that this first part will only treat creep and plasticity, since viscoelasticity is somewhat different and explained on its own at the end of this section.

A single link/network/phase

Infinitesimal description

The inelasticity feature assumes that the strain or strain rate is somehow decomposed into an elastic and inelastic part. This decomposition is in general not trivial and depends upon the underlying material model, but to make things simple we can begin by restricting ourselves to a small deformation context. In this case the decomposition is *additive*, so

$$\varepsilon = \varepsilon_e + \varepsilon_i ,$$

where $\boldsymbol{\varepsilon}$ is the *total* (given) strain, $\boldsymbol{\varepsilon}_e$ is the *elastic* strain, and $\boldsymbol{\varepsilon}_i$ is the *inelastic* strain. A material model then amounts to determining the stress for the elastic strain, which can be written as

$$\boldsymbol{\sigma} = \boldsymbol{\sigma}(\boldsymbol{\varepsilon}_e) = \boldsymbol{\sigma}(\boldsymbol{\varepsilon} - \boldsymbol{\varepsilon}_i).$$

The material model used as a basis for this feature, that is, the model indicated by parameter MID above, here acts as the function $\boldsymbol{\sigma}(\ast)$. If no inelasticity is added to the model, $\boldsymbol{\varepsilon}_i = \mathbf{0}$ and the stress will be given by $\boldsymbol{\sigma}(\boldsymbol{\varepsilon})$. It is simply a plain evaluation of the material model in the absence of this keyword. For linear elasticity, for instance, the function would be given by Hooke's law

$$\boldsymbol{\sigma}(\boldsymbol{\varepsilon}) = \mathbf{C}\boldsymbol{\varepsilon} ,$$

where \mathbf{C} is the Hooke elasticity tensor. Needless to say, the material model itself can deal with inelasticities of various kinds, such as plasticity, creep, thermal expansion and viscoelasticity, so the variable $\boldsymbol{\varepsilon}_i$ is restricted to the inelasticities specifically defined here and thus added to whatever is used in the material model. For the sake of generality, we allow the inelastic strain to come from many sources and be combined:

$$\boldsymbol{\varepsilon}_i = \boldsymbol{\varepsilon}_i^1 + \boldsymbol{\varepsilon}_i^2 + \boldsymbol{\varepsilon}_i^3 + \dots .$$

Here each superscript on the right-hand side refers to a specific combination of LAW and MODEL (excluding viscoelastic laws).

Large strain formulation

For incrementally updated material models, using hypoelasticity with an objective rate of stress, the exposition above is generalized to large deformations by applying the appropriate time derivative to strains and stresses:

$$\boldsymbol{\varepsilon} \rightarrow \mathbf{D}, \quad \boldsymbol{\varepsilon}_e \rightarrow \mathbf{D}_e, \quad \boldsymbol{\varepsilon}_i \rightarrow \mathbf{D}_i, \quad \boldsymbol{\sigma} \rightarrow \boldsymbol{\sigma}^\nabla, \dots$$

Here \mathbf{D} is the rate of deformation tensor, and ∇ indicates an objective time derivative³. For now, we restrict the evolution of inelastic strain to be based on a von Mises stress potential:

$$\mathbf{D}_i^j = \dot{\boldsymbol{\varepsilon}}_i^j \frac{\partial \bar{\sigma}}{\partial \boldsymbol{\sigma}} ,$$

where

$$\bar{\sigma} = \sqrt{\frac{3}{2} \mathbf{s} : \mathbf{s}} \quad \left(\mathbf{s} = \boldsymbol{\sigma} - \frac{1}{3} \boldsymbol{\sigma} : \mathbf{I} \right)$$

is the von Mises effective stress, and $\dot{\boldsymbol{\varepsilon}}_i^j$ is the rate of effective inelastic strain for the MODEL and LAW corresponding to superscript j . The constitutive law is thus written as

$$\boldsymbol{\sigma}^\nabla = \boldsymbol{\sigma}^\nabla(\mathbf{D}_e) = \boldsymbol{\sigma}^\nabla(\mathbf{D} - \mathbf{D}_i) .$$

³ In LS-DYNA the objective rate is to be understood as the Jaumann rate for solid elements and the rate resulting from the specific co-rotational formulation for shell elements.

For hyperelastic materials the role of D_e is replaced by the *elastic deformation gradient*, F_e , and instead of a constitutive law for the rate of stress, the total stress is given as

$$\sigma = \sigma(F_e) .$$

The evolution of the elastic deformation gradient is taken as

$$\dot{F}_e = (L - L_i)F_e ,$$

where $L = \frac{\partial v}{\partial x}$ is the *spatial velocity gradient* and L_i is the inelastic part. For simplicity, we assume zero plastic spin for all involved features, thus $W_i = \mathbf{0}$ and $L_i = D_i$.

From here, we will give the evolution law of the effective inelastic strain for the available contributions.

Isotropic hardening (LAW = 3)

The current yield stress is defined as

$$\sigma_Y = \begin{cases} \sigma_0 + H\varepsilon_p & \text{MODEL} = 1 \\ c(\varepsilon_p, \dot{\varepsilon}_p) & \text{MODEL} = 2 \end{cases} ,$$

where the inelastic strain is represented by the plastic strain, ε_p , and c is the curve or table used to evaluate the yield stress. The evolution of plastic strain is given by the KKT condition

$$\bar{\sigma} - \sigma_Y \leq 0, \quad \dot{\varepsilon}_p \geq 0, \quad (\bar{\sigma} - \sigma_Y)\dot{\varepsilon}_p = 0 .$$

In other words, it is the classical von Mises plasticity available in many standard plasticity models; see, for instance, *MAT_PIECEWISE_LINEAR_PLASTICITY (*MAT_024). As an example, materials 1 and 2 below are equivalent.

```
*MAT_ELASTIC
$      mid      ro      e      pr
      1      7.8e-9  210000.0  0.3
*MAT_ADD_INELASTICITY
$      mid
      1
$  nielaws
      1
$      law      model
      3          2
$      cid
      1
*MAT_PIECEWISE_LINEAR_PLASTICITY
$      mid      ro      e      pr
      1      7.8e-9  210000.0  0.3
$
                        lcsc
                        1
```

CID/LCSS can be either a curve or table defining effective stress as a function of effective plastic strain.

Creep (LAW = 5)

For creep, the inelastic strain is represented by the creep strain, ε_c . The evolution depends on the model specified.

- a) *Norton incremental formulation (MODEL = 1)*

$$\dot{\varepsilon}_c = A\bar{\sigma}^m t^n.$$

This is essentially the creep law available in *MAT_THERMO_ELASTO_VISCOPLASTIC_CREEP (*MAT_188).

- b) *Norton total formulation (MODEL = 2).*

$$\dot{\varepsilon}_c = \frac{d}{dt} (A\bar{\sigma}^m t^n) .$$

This is essentially the creep law available in *MAT_UNIFIED_CREEP (*MAT_115), with some slight modifications.

- c) *Norton-Bailey formulation (MODEL = 3).*

$$\dot{\varepsilon}_c = \left(A \left(\frac{\bar{\sigma}}{\sigma_0} \right)^n \left(\frac{T}{T_0} \right)^p \left((m+1)(\varepsilon_0 + \varepsilon_c) \right)^m \right)^{\frac{1}{m+1}} .$$

Here T is the current temperature.

- d) *Bergström-Boyce formulation (MODEL = 4).*

$$\dot{\varepsilon}_c = A(\lambda_c - 1 + E)^C \bar{\sigma}^m ,$$

where $\lambda_c = \sqrt{\frac{1}{3} \mathbf{I} : \mathbf{B}_c} \geq 1$ and $\mathbf{B}_c = \exp\{2\varepsilon_c\}$

Viscoelasticity (LAW = 6)

In the absence of viscoelasticity, we are now done with the description of the stress update, and we simply set

$$s_I = s$$

$$p_I = p$$

where we use s_I and p_I to denote the final deviatoric stress and pressure in link I that is used in the weighted sum at the beginning of this section. The s and p are to be understood as the deviatoric stress and pressure resulting from treatment of creep and plasticity that we just covered, so $\sigma = s - p\mathbf{I}$. For viscoelasticity the stress in link I will be subject to stress decay (relaxation and creep), in that it evolves according to the specified

viscoelastic law. For deviatoric and volumetric decay coefficients β_s and β_p , we have for the hypoelastic laws (MODEL = 1 and MODEL = 4):

$$\begin{aligned}\mathbf{s}_I^\nabla &= \mathbf{s}^\nabla - \beta_s \mathbf{s}_I \\ \dot{p}_I &= \dot{p} - \beta_p p_I\end{aligned}$$

The hyperelastic laws are formulated directly in terms of the Kirchhoff stress $\boldsymbol{\tau} = J\boldsymbol{\sigma}$, where $J = \det \mathbf{F}$. More specifically, using the notation $q = -\frac{1}{3}\boldsymbol{\tau}:\mathbf{I}$ and $\mathbf{t} = \boldsymbol{\tau} + q\mathbf{I}$, we have for hyperelastic law #1 (MODEL = 2)

$$\begin{aligned}\mathbf{t}_I &= \mathbf{t} - \text{dev} \left[\beta_s \int_0^t e^{-\beta_s(t-s)} \bar{\mathbf{F}}_{s \rightarrow t} \mathbf{t}(s) \bar{\mathbf{F}}_{s \rightarrow t}^T ds \right] \\ q_I &= q - \beta_p \int_0^t e^{-\beta_p(t-s)} q(s) ds\end{aligned}$$

and for hyperelastic law #2 (MODEL = 3)

$$\begin{aligned}\mathbf{t}_I &= \mathbf{t} - \text{sym} \left[\beta_s \int_0^t e^{-\beta_s(t-s)} \mathbf{F}_{s \rightarrow t} \mathbf{t}(s) \mathbf{F}_{s \rightarrow t}^{-1} ds \right] \\ q_I &= q - \beta_p \int_0^t e^{-\beta_p(t-s)} q(s) ds\end{aligned}$$

The Kirchhoff stress for link I is obtained as $\boldsymbol{\tau}_I = \mathbf{t}_I - q_I \mathbf{I}$. Here we use $\bar{\mathbf{F}}_{s \rightarrow t} = J_{s \rightarrow t}^{-1/3} \mathbf{F}_{s \rightarrow t}$ where $J_{s \rightarrow t} = \det \mathbf{F}_{s \rightarrow t}$ and $\mathbf{F}_{s \rightarrow t}$ is the deformation gradient between the configuration at time s and time t . For law #1, $\bar{\mathbf{F}}_{s \rightarrow t}$ is used to push the stress forward from time s to time t , while for law #2, $\mathbf{F}_{s \rightarrow t}$ is used to transform the stress from time s to time t , both essential to preserve frame invariance.

The decay coefficients can be constants but can also dependent on the state of the system (stress, internal variables, temperature, etc.). Note that if the decay coefficients are equal to zero ($\beta_s = \beta_p = 0$), this is equivalent to not having viscoelasticity. Currently, we can specify temperature dependent decay coefficients to affect both the deviatoric and volumetric stress, formalized in the following.

Linear viscoelasticity (MODEL = 1)

For viscoelasticity, the decay of stress is governed by the decay coefficients β_s and β_p , optionally incorporating shift functions depending on the temperature T . In this implementation, the shear and bulk decay are given as

$$\begin{aligned}\beta_s &= \beta_G \phi_G(T) \\ \beta_p &= \beta_K \phi_K(T)\end{aligned}$$

where ϕ_* (* being G or K) are shift functions given by

$$\phi_*(T) = \begin{cases} e^{-A_*\left(\frac{1}{T}-\frac{1}{T_*}\right)} & \text{if } B_* = 0 \text{ (Arrhenius)} \\ e^{-A_*\left(\frac{T-T_*}{B_*+T-T_*}\right)} & \text{if } B_* \neq 0 \text{ (Williams - Landel - Ferry)} \end{cases}$$

This is essentially the viscoelastic law available in *MAT_GENERAL_VISCOELASTIC (*MAT_076), except that the driving mechanism for the stress is here s^∇ and \dot{p} rather than $2G_I D_{\text{dev}}$ and $K_I D_{\text{vol}}$. Note also, that in contrast to *MAT_076, the shift coefficients are to be given for each link and for both the shear and bulk decay. This allows for using independent shifts for each link, and if the traditional usage of the shift functions is desired one needs to put the same triplet (i.e., the values of T_* , A_* and B_*) on all links (parameters P3-P5 for shear, and P6-P8 for bulk). If *MAT_ELASTIC is used in combination with viscoelasticity here, the two formulations can be made (almost) equivalent after proper transformation of input data. For instance, the following two material definitions (1 and 2) are equivalent;

```
*MAT_ELASTIC
$      mid      ro      e      pr
      1      7.8e-9 210000.0      0.2
*MAT_ADD_INELASTICITY
$      mid  nielinks
      12
$  nielaws  weight
      10.3
$      law  model
      6      1
$  betag  betak
      0.05
$  nielaws  weight
      10.5
$      law  model
      6      1
$  betag  betak
      0.005
*MAT_GENERAL_VISCOELASTIC
$      mid      ro      bulk
      2      7.8e-9 116666.67
$ blank card

$      g      betag
43750.0      0.005
26250.0      0.05
17500.0
```

In general, with

$$G = \frac{E}{2(1 + \nu)}, \quad K = \frac{E}{3(1 - 2\nu)}$$

in *MAT_ELASTIC, and G_I and K_I in *MAT_GENERAL_VISCOELASTIC, we have

$$G = \sum G_I, \quad K = \sum K_I$$

while the weights are given as

$$w_I = \frac{G_I}{G} = \frac{K_I}{K}$$

which implies that the add inelasticity approach is somewhat more restrictive than the general approach. However, an almost pure shear/bulk link can be created by setting the bulk/shear decay coefficient to a very large number compared to the simulation time. To be specific, to get a shear link set $\beta_K \gg 1/T$ and to get a bulk link set $\beta_G \gg 1/T$, where T is the termination time. See also VFLAG in *MAT_GENERAL_HYPERELASTIC_RUBBER for the difference of the two approaches.

Nonlinear viscoelasticity

The nonlinear creep laws (LAW = 5) can be formulated as nonlinear viscoelastic laws (LAW = 6) by setting

$$\beta_s = \frac{G}{\sigma_I} \dot{\epsilon}_c$$

$$\beta_p = 0$$

where G is an estimated elastic stiffness of the base material, σ_I is the von Mises effective stress of s_I and $\dot{\epsilon}_c$ is the creep law of interest. Currently the following models are supported

- e) *Norton-Bailey formulation (MODEL = 4).*

$$\dot{\epsilon}_c = \left(A \left(\frac{\sigma_I}{\sigma_0} \right)^n \left(\frac{T}{T_0} \right)^p \left((m+1)(\epsilon_0 + \epsilon_c) \right)^m \right)^{\frac{1}{m+1}},$$

where T is the current temperature.

- f) *Bergström-Boyce formulation (MODEL = 5).*

$$\dot{\epsilon}_c = A(\lambda_c - 1 + E)^C \sigma_I^m,$$

where $\lambda_c = \sqrt{\frac{1}{3} \mathbf{I} : \mathbf{B}_c} \geq 1$ and $\mathbf{B}_c = \exp\{2\epsilon_c\}$

For linear elasticity the creep and nonlinear viscoelastic laws are equivalent. For other models they are similar assuming that a reasonable value of G is used (see input field 4 on Card 1).

History

With *DEFINE_MATERIAL_HISTORIES you can output the effective plastic and creep strains for plastic and creep models, respectively. The presence of this keyword in the

input deck will automatically move the total plastic strain to the appropriate location in the d3plot database. Its value will be

$$\epsilon_p = \sum_{I=1}^{NIELINKS} w_I \epsilon_p^I$$

The creep strain can also be retrieved similarly as shown in the following table.

<i>*DEFINE_MATERIAL_HISTORIES Properties</i>		
Label	Attributes	Description
Effective Creep Strain	- - - -	$\epsilon_c = \sum_{I=1}^{NIELINKS} w_I \epsilon_c^I$

***MAT_ADD_PERMEABILITY**

Add permeability to material model for consolidation calculations. See *CONTROL_-PORE_FLUID.

Card 1	1	2	3	4	5	6	7	8
Variable	MID	PERM	PERMY	PERMZ	THEXP	LCKZ	PMTYP	
Type	A	F/I	F/I	F/I	F	I	I	
Default	none	none	PERM	PERM	0.0	none	0	

VARIABLE**DESCRIPTION**

MID	Material identification – must be same as the structural material.
PERM	Permeability or load curve ID defining permeability, depending on the definition of PMTYP below. If PERMY and PERMZ are non-zero, then PERM gives the permeability in the global X direction. See Remark 3 .
PERMY	Optional permeability or load curve ID defining permeability in the global Y direction, depending on the definition of PMTYP below
PERMZ	Optional permeability or load curve ID defining permeability in the global Z direction, depending on the definition of PMTYP below
THEXP	Undrained volumetric thermal expansion coefficient (see Remark 2): GE.0.0: Constant undrained volumetric thermal expansion coefficient LT.0.0: THEXP is the ID of a load curve giving the thermal expansion coefficient (<i>y</i> -axis) as a function of temperature (<i>x</i> -axis).
LCKZ	Load curve giving factor on PERM as a function of z-coordinate
PMTYP	Permeability definition type: EQ.0: PERM is a constant.

VARIABLE	DESCRIPTION
	EQ.1: PERM is a load curve ID giving permeability (y -axis) as a function of the volume ratio of current volume to volume in the stress-free state (x -axis).
	EQ.2: PERM is a load curve ID giving permeability (y -axis) as a function of effective plastic strain (x -axis) of materials other than MAT_072R3. For MAT_072R3, the x -axis is the output selector specified by NOUT; see *MAT_072R3.
	EQ.3: PERM is a load curve ID giving permeability (y -axis) as a function of effective pressure (x -axis) which is positive when in compression.

Remarks:

1. **Permeability Units.** The units of PERM are length/time (volume flow rate of water per unit area per gradient of pore pressure head).
2. **Thermal Expansion.** THEXP represents the thermal expansion of the material caused by the pore fluid (units: 1/temperature). It should be set equal to $n\alpha_w$, where n is the porosity of the soil and α_w is the volumetric thermal expansion coefficient of the pore fluid. If the pore fluid is water, the thermal expansion coefficient varies strongly with temperature; a curve of coefficient as a function of temperature may be input instead of a constant value. Note that this property is for *volumetric* strain increase, whereas regular thermal expansion coefficients (e.g. on *MAT or *MAT_ADD_THERMAL_EXPANSION) are linear, meaning they describe thermal expansion in one direction. The volumetric expansion coefficient is three times the linear thermal expansion coefficient. The regular thermal expansion coefficients apply to the soil skeleton and to drained parts. Pore pressure can be generated due to the difference of expansion coefficients of the soil skeleton and pore fluid, that is, if THEXP is not equal to three times the regular thermal expansion coefficient for the part.
3. **Isotropic/Orthotropic Permeability.** If only PERM is defined and PERMY and PERMZ are left blank or zero, the permeability is isotropic. To obtain orthotropic permeability, define values for PERM, PERMY and PERMZ, giving the permeability in the global X, Y and Z directions respectively.

***MAT_ADD_PORE_AIR**

For pore air pressure calculations.

Card 1	1	2	3	4	5	6	7	8
Variable	MID	PA_RHO	PA_PRE	PORE				
Type	A	I	F	F				
Default	none	AIR_RO	AIR_RO	1.				
Remarks	1			1, 2				

Card 2	1	2	3	4	5	6	7	8
Variable	PERM1	PERM2	PERM3	CDARCY	CDF	LCPGD1	LCPGD2	LCPGD3
Type	F	F	F	F	F	I	I	I
Default	0.	PERM1	PERM1	1.	0.	none	LCPGD1	LCPGD1
Remarks	2, 3, 4, 5	2, 3, 4, 5	2, 3, 4, 5	1	1, 5	6	6	6

VARIABLE**DESCRIPTION**

MID	Material identification which must be same as the structural material
PA_RHO	Initial density of pore air. The default is the atmospheric air density, AIR_RO, defined in *CONTROL_PORE_AIR
PA_PRE	Initial pressure of pore air. The default is the atmospheric air pressure, AIR_P, defined in *CONTROL_PORE_AIR
PORE	Porosity, meaning the ratio of pores to total volume (default = 1)

VARIABLE	DESCRIPTION
PERMi	Permeability of pore air along x , y , and z -directions. If less than 0, PERMi is taken to be the curve ID defining the permeability coefficient as a function of volume ratio of current volume to volume in the stress free state.
CDARCY	Coefficient of Darcy's law
CDF	Coefficient of Dupuit-Forchheimer law
LCPGDi	Curves defining non-linear Darcy's laws along x , y and z -directions

Remarks:

- Card 1.** This card must be defined for all materials requiring consideration of pore air pressure. The pressure contribution of pore air is $(\rho - \rho_{\text{atm}})RT \times \text{PORE}$, where ρ and ρ_{atm} are the current and atmospheric air densities, R is air's gas constant, T is atmospheric air temperature and PORE is the porosity. The values for R , T and PORE are assumed to be constant during simulation.
- Permeability Model.** The unit of PERMi is $[\text{Length}]^3[\text{time}]/[\text{mass}]$, (air flow velocity per gradient of excess pore pressure), i.e.

$$(\text{CDARCY} + \text{CDF} \times |v_i|) \times \text{PORE} \times v_i = \text{PERMi} \times \frac{\partial P_a}{\partial x_i}, \quad i = 1,2,3$$

where v_i is the pore air flow velocity along the i^{th} direction, $\partial P_a / \partial x_i$ is the pore air pressure gradient along the i^{th} direction, and $x_1 = x$, $x_2 = y$, $x_3 = z$.

- Default Values for PERM2 and PERM3.** PERM2 and PERM3 are assumed to be equal to PERM1 when they are not defined. A definition of "0" means no permeability.
- Local Coordinate Systems.** When MID is an orthotropic material, such as *MAT_002 or *MAT_142, (x, y, z) , or $(1,2,3)$, refers to the local material coordinate system (a, b, c) ; otherwise it refers to the global coordinate system.
- CDF for Viscosity.** CDF can be used to consider the viscosity effect for high speed air flow.
- Nonlinearity.** LCPGDi can be used to define a non-linear Darcy's law as follows:

$$(\text{CDARCY} + \text{CDF} \times |v_i|) \times \text{PORE} \times v_i = \text{PERMi} \times f_i \frac{\partial P_a}{\partial x_i}, \quad i = 1,2,3$$

where f_i is the value of the function defined by the LCPGD i field. The linear version of Darcy's law (see [Remark 2](#)) can be recovered when the LCPGD i curves are defined as straight lines of slope of 1.

***MAT_ADD_PROPERTY_DEPENDENCE_{OPTION}**

Available options include:

FREQ

TIME

The ADD_PROPERTY_DEPENDENCE option defines dependence of a material property on frequency or time.

Card 1	1	2	3					
Variable	MID	PROP	LCID					
Type	A	C	I					
Default	none	none	0					

VARIABLE**DESCRIPTION**

MID	Material identification for which the property dependence applies
PROP	Name of the property (same as the variable for a material model in keyword card). For example, "E" is used for Young's modulus in *MAT_ELASTIC. See Remark 4 .
LCID	Curve ID to define the property dependence. For the FREQ keyword option, the abscissa values define frequency; for the TIME keyword option, the abscissa values define time. The ordinate values define the property at each frequency or each time

Remarks:

1. **Overview.** This keyword defines how a property (for example, the Young's modulus) of a material changes with frequency (for FREQ option) or with time (for TIME option). Particularly, *MAT_ADD_PROPERTY_DEPENDENCE_-FREQ can be used in direct SSD analysis (*FREQUENCY_DOMAIN_SSD_DIRECT_FREQUENCY_DEPENDENT).
2. **Properties without Frequency/Time Dependence.** Some properties of a material model have no frequency or time dependence. A warning message will be

issued if a dependence curve is defined on a property of a material, which has no frequency or time dependence.

3. **Initial Property Values.** The original property value defined in a material card will be overridden by the property values defined at frequency or time 0 in this keyword. If the starting frequency or time of LCID in this keyword is larger than 0, then the original property value defined in the material card is used until the starting frequency or time of LCID is reached.
4. **Supported Material Models and Properties.** So far, only the Young's modulus (E) of *MAT_ELASTIC is supported by this keyword. More material models (and properties) will be supported in the future.

*MAT_ADD_PZELECTRIC

The ADD_PZELECTRIC option is used to occupy an arbitrary material model in LS-DYNA with a piezoelectric property. This option applies to 4-node solids, 6-node solids, 8-node solids, thick shells, 2D plane strain elements and axisymmetric solids. Orthotropic properties are assumed. This feature is available in SMP since 115324/dev and MPP since 126577/dev. We recommend a double precision executable.

Card Summary:

Card 1. This card is required.

MID	DTYPE	GPT	AOPT				
-----	-------	-----	------	--	--	--	--

Card 2. This card is required.

DXX	DYY	DZZ	DXY	DXZ	DYZ		
-----	-----	-----	-----	-----	-----	--	--

Card 3. This card is required.

PX11	PX22	PX33	PX12	PX13	PX23	PY11	PY22
------	------	------	------	------	------	------	------

Card 4. This card is required.

PY33	PY12	PY13	PY23	PZ11	PZ22	PZ33	PZ12
------	------	------	------	------	------	------	------

Card 5. This card is required.

PZ13	PZ23						
------	------	--	--	--	--	--	--

Card 6. This card is required.

XP	YP	ZP	A1	A2	A3		
----	----	----	----	----	----	--	--

Card 7. This card is required.

			D1	D2	D3		
--	--	--	----	----	----	--	--

Data Card Definitions:

Card 1	1	2	3	4	5	6	7	8
Variable	MID	DTYPE	GPT	AOPT				
Type	A	A	F	I				
Default	none	S	8	0				

VARIABLE**DESCRIPTION**

MID	Material ID for which the piezoelectric properties apply
DTYPE	Type of piezoelectric property definition (see remarks below) EQ.S: Stress based definition EQ.E: Strain based definition
GPT	Number of Gauss points used for integration: EQ.0: Default value 8, full integration EQ.1: Reduced integration
AOPT	Material axes option (see <i>MAT_OPTIONTROPIC_ELASTIC</i> for a more complete description): EQ.0.0: Locally orthotropic with material axes determined by element nodes 1, 2, and 4, as with <i>*DEFINE_COORDINATE_NODES</i> . EQ.1.0: Locally orthotropic with material axes determined by a point in space and the global location of the element center; this is the a -direction. This option is for solid elements only. EQ.2.0: Globally orthotropic with material axes determined by vectors defined below, as with <i>*DEFINE_COORDINATE_VECTOR</i> .

Card 2	1	2	3	4	5	6	7	8
Variable	DXX	DYY	DZZ	DXY	DXZ	DYZ		
Type	F	F	F	F	F	F		

VARIABLE**DESCRIPTION** $D_{\alpha\beta}$ Dielectric permittivity matrix, $d_{\alpha\beta}$. $\alpha, \beta = x, y, z$ (see remarks below).

Card 3	1	2	3	4	5	6	7	8
Variable	PX11	PX22	PX33	PX12	PX13	PX23	PY11	PY22
Type	F	F	F	F	F	F	F	F

Card 4	1	2	3	4	5	6	7	8
Variable	PY33	PY12	PY13	PY23	PZ11	PZ22	PZ33	PZ12
Type	F	F	F	F	F	F	F	F

Card 5	1	2	3	4	5	6	7	8
Variable	PZ13	PZ23						
Type	F	F						

VARIABLE**DESCRIPTION** $P_{\alpha ij}$ Piezoelectric matrix which depends on DTYPE (see remarks below). $\alpha = x, y, z$ and $i, j = 1, 2, 3$.

Card 6	1	2	3	4	5	6	7	8
Variable	XP	YP	ZP	A1	A2	A3		
Type	F	F	F	F	F	F		

VARIABLE**DESCRIPTION**

XP, YP, ZP

Coordinates of point p for AOPT = 1

A1, A2, A3

Components of vector \mathbf{a} for AOPT = 2

Card 7	1	2	3	4	5	6	7	8
Variable				D1	D2	D3		
Type				F	F	F		

VARIABLE**DESCRIPTION**

D1, D2, D3

Components of vector \mathbf{d} for AOPT = 2**Remarks:**

The stress-based definition for piezoelectric effects is:

$$\sigma_{ij} = k_{ijkl}\varepsilon_{kl} - p_{\alpha ij}E_{\alpha}$$

$$\Delta_{\alpha} = p_{\alpha kl}\varepsilon_{kl} + d_{\alpha\beta}E_{\beta}$$

Here σ_{ij} are the mechanical stresses, k_{ijkl} are the material stiffness constants, ε_{kl} are the material strains, $p_{\alpha ij}$ are the stress-based piezoelectric coefficients, Δ_{α} are the electric displacements, E_{α} are the electric fields, and $d_{\alpha\beta}$ are the dielectric permittivity constants.

The strain-based definition for piezoelectric effects is:

$$\varepsilon_{ij} = f_{ijkl}\sigma_{kl} + P_{\alpha ij}E_{\alpha}$$

$$\Delta_{\alpha} = P_{\alpha kl}\sigma_{kl} + d_{\alpha\beta}E_{\beta}$$

Here f_{ijkl} are the material flexibility parameters and $P_{\alpha ij}$ are the strain-based piezoelectric coefficients.

***MAT_ADD_SOC_EXPANSION**

The ADD_SOC_EXPANSION option adds a state of charge (SOC) expansion property to an (arbitrary) material model in LS-DYNA. The state of charge comes from the EM module during a coupled simulation. This option currently only applies to solid elements type -2, -1, 1, 2, and 10 and to hypoelastic material models.

Card 1	1	2	3	4	5	6	7	8
Variable	PID	LCID	MULT	LCIDY	MULTY	LCIDZ	MULTZ	
Type	I	I	F	I	F	I	F	
Default	none	0	1.0	LCID	MULT	LCID	MULT	

VARIABLE**DESCRIPTION**

PID	Part ID for which the SOC expansion property applies
LCID	For isotropic material models, LCID is the load curve ID defining the SOC expansion coefficient as a function of state of charge. In this case, LCIDY, MULTY, LCIDZ, and MULTZ are ignored. For anisotropic material models, LCID and MULT define the SOC expansion coefficient in the local material <i>a</i> -direction. In either case, if LCID is zero, the SOC expansion coefficient is constant and equal to MULT.
MULT	Scale factor scaling load curve given by LCID
LCIDY	Load curve ID defining the SOC expansion coefficient in the local material <i>b</i> -direction as a function of state of charge. If zero, the SOC expansion coefficient in the local material <i>b</i> -direction is constant and equal to MULTY. If MULTY = 0.0 as well, LCID and MULT specify the SOC expansion coefficient in the local material <i>b</i> -direction.
MULTY	Scale factor scaling load curve given by LCIDY

VARIABLE	DESCRIPTION
LCIDZ	Load curve ID defining the SOC expansion coefficient in the local material <i>c</i> -direction as a function of state of charge. If zero, the SOC expansion coefficient in the local material <i>c</i> -direction is constant and equal to MULTZ. If MULTZ = 0.0 as well, LCID and MULT specify the SOC expansion coefficient in the local material <i>c</i> -direction.
MULTZ	Scale factor scaling load curve given by LCIDZ

Remarks:

When invoking the isotropic SOC expansion property (no local *y* and *z* parameters) for a material, the stress update is based on the elastic strain rates given by

$$\dot{\epsilon}_{ij}^e = \dot{\epsilon}_{ij} - \gamma(\text{SOC})\dot{\text{SOC}} \times \delta_{ij}$$

rather than on the total strain rates, $\dot{\epsilon}_{ij}$. For orthotropic properties, which apply only to materials with anisotropy, this equation is generalized to

$$\dot{\epsilon}_{ij}^e = \dot{\epsilon}_{ij} - \gamma_k(\text{SOC})\dot{\text{SOC}} q_{ik}q_{jk} .$$

Here q_{ij} represents the matrix with material directions with respect to the current configuration.

***MAT_ADD_THERMAL_EXPANSION**

The ADD_THERMAL_EXPANSION option adds a thermal expansion property to an arbitrary material model in LS-DYNA. This option applies to all nonlinear solid, shell, thick shell and beam elements and to all material models except those models which use resultant formulations, such as *MAT_RESULTANT_PLASTICITY and *MAT_SPECIAL_ORTHOTROPIC. Orthotropic expansion effects are supported for anisotropic materials.

Card 1	1	2	3	4	5	6	7	8
Variable	PID	LCID	MULT	LCIDY	MULTY	LCIDZ	MULTZ	
Type	I	I	F	I	F	I	F	
Default	none	none	1.0	LCID	MULT	LCID	MULT	

VARIABLE**DESCRIPTION**

PID	Part ID for which the thermal expansion property applies
LCID	For isotropic material models, LCID is the load curve ID defining the thermal expansion coefficient as a function of temperature. In this case, LCIDY, MULTY, LCIDZ, and MULTZ are ignored. For anisotropic material models, LCID and MULT define the thermal expansion coefficient in the local material <i>a</i> -direction. In either case, if LCID is zero, the thermal expansion coefficient is constant and equal to MULT.
MULT	Scale factor scaling load curve given by LCID
LCIDY	Load curve ID defining the thermal expansion coefficient in the local material <i>b</i> -direction as a function of temperature. If zero, the thermal expansion coefficient in the local material <i>b</i> -direction is constant and equal to MULTY. If MULTY = 0 as well, LCID and MULT define the thermal expansion coefficient in the local material <i>b</i> -direction.
MULTY	Scale factor scaling load curve given by LCIDY

VARIABLE	DESCRIPTION
LCIDZ	Load curve ID defining the thermal expansion coefficient in the local material c -direction as a function of temperature. If zero, the thermal expansion coefficient in the local material c -direction is constant and equal to MULTZ. If MULTZ = 0 as well, LCID and MULT define the thermal expansion coefficient in the local material c -direction.
MULTZ	Scale factor scaling load curve given by LCIDZ

Remarks:

When invoking the isotropic thermal expansion property (no local y and z parameters) for a material, the stress update is based on the elastic strain rates given by

$$\dot{\epsilon}_{ij}^e = \dot{\epsilon}_{ij} - \alpha(T)\dot{T}\delta_{ij}$$

rather than on the total strain rates $\dot{\epsilon}_{ij}$. For a material with the stress based on the deformation gradient, F_{ij} , the elastic part of the deformation gradient is used for the stress computations:

$$F_{ij}^e = J_T^{-1/3} F_{ij} ,$$

where J_T is the thermal Jacobian. The thermal Jacobian is updated using the rate given by

$$\dot{J}_T = 3\alpha(T)\dot{T}J_T .$$

For orthotropic properties, which apply only to materials with anisotropy, these equations are generalized to

$$\dot{\epsilon}_{ij}^e = \dot{\epsilon}_{ij} - \alpha_k(T)\dot{T}q_{ik}q_{jk}$$

and

$$F_{ij}^e = F_{ik}\beta_l^{-1}Q_{kl}Q_{jl} ,$$

where the β_i are updated as

$$\dot{\beta}_i = \alpha_i(T)\dot{T}\beta_i .$$

Here q_{ij} represents the matrix with material directions with respect to the current configuration whereas Q_{ij} are the corresponding directions with respect to the initial configuration. For (shell) materials with multiple layers of different anisotropy directions, the mid surface layer determines the orthotropy for the thermal expansion.

***MAT_NONLOCAL**

In nonlocal failure theories, the failure criterion depends on the state of the material within a radius of influence which surrounds the integration point. An advantage of nonlocal failure is that mesh size sensitivity on failure is greatly reduced leading to results which converge to a unique solution as the mesh is refined.

Without a nonlocal criterion, strains will tend to localize randomly with mesh refinement leading to results which can change significantly from mesh to mesh. The nonlocal failure treatment can be a great help in predicting the onset and the evolution of material failure. This option can be used with two and three-dimensional solid elements, three-dimensional shell elements, and thick shell elements. This option applies to a subset of elasto-plastic materials that include a damage-based failure criterion.

Card 1	1	2	3	4	5	6	7	8
Variable	IDNL	PID	P	Q	L	NFREQ	NHV	NHVT
Type	I	I	F	F	F	I	I	I
Default	none	none	none	none	none	none	none	none

History Cards. Include as many cards as needed to identify the NHV and NHVT history variables. *One card 2 will be read, even if both NHV and NHVT are zero.* If only NHV > 0, then NL_i are assumed to be incremental variables. If only NHVT > 0, then NL_i are assumed to be non-incremental variables. If both NHV and NHVT are nonzero, then NHV variables will be read starting at Card 2, and NHVT variables will be read starting on a new line.

Card 2	1	2	3	4	5	6	7	8
Variable	NL1	NL2	NL3	NL4	NL5	NL6	NL7	NL8
Type	I	I	I	I	I	I	I	I
Default	none	none	none	none	none	none	none	none

Symmetry Plane Cards. Define one card for each symmetry plane. Up to six symmetry planes can be defined. The next keyword (“*”) card terminates this input.

Cards 3	1	2	3	4	5	6	7	8
Variable	XC1	YC1	ZC1	XC2	YC2	ZC2		
Type	F	F	F	F	F	F		
Default	none	none	none	none	none	none		

VARIABLE**DESCRIPTION**

IDNL	Nonlocal material input ID
PID	Part ID for nonlocal material
P	Exponent of weighting function. A typical value might be 8 depending somewhat on the choice of L. See Remark 4 .
Q	Exponent of weighting function. A typical value might be 2. See Remark 4 .
L	Characteristic length. This length should span a few elements. See Remark 4 .
NFREQ	Number of time steps between searching for integration points that lie in the neighborhood. Nonlocal smoothing will be done each cycle using these neighbors until the next search is done. The neighbor search can add significant computational time, so it is suggested that NFREQ be set to a value between 10 and 100 depending on the problem. This parameter may be somewhat problem dependent. If NFREQ = 0, a single search will be done at the start of the calculation.
NHV	Number of variables with nonlocal treatment of increments. See Remark 1
NHVT	Number of variables with nonlocal treatment of total values. See Remark 1 .
NL1, ..., NL8	Identifies the history variable(s) for nonlocal treatment. Define NHV + NHVT values (maximum of 8 values per line). See Remark 2 .

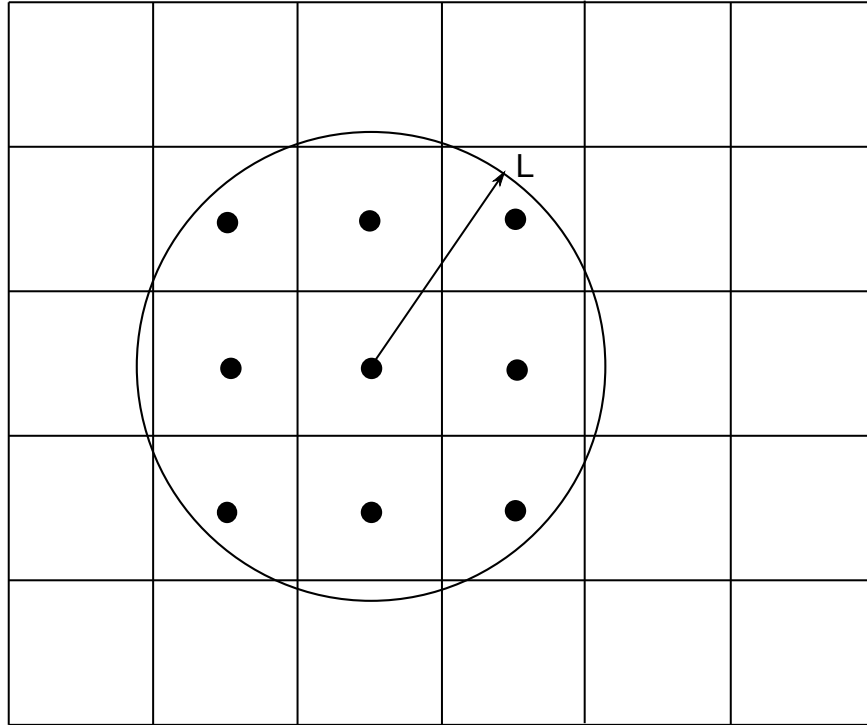

Figure 2-6. Here \dot{f}_r and x_r are respectively the nonlocal rate of increase of damage and the center of the element e_r , and \dot{f}_{local}^i , V_i and y_i are respectively the local rate of increase of damage, the volume and the center of element e_i .

VARIABLE	DESCRIPTION
XC1, YC1, ZC1	Coordinate of point on symmetry plane
XC2, YC2, ZC2	Coordinate of a point along the normal vector

Remarks:

1. **NHV and NHVT.** NHV is a count of the number of variables for which increments of the variable are used in the nonlocal function. NHVT is a count of the number of variables for which the whole value of the variable is used in the nonlocal function. NHVT type variables would be used only if the variable is itself an increment of some value which is rare. Many history variables are calculated by a sum of increments, but since the variable is the sum, one would include this variable in the NHV type variables for nonlocal treatment so that only the increments are modified.
2. **History Variables.** For elastoplastic material models in LS-DYNA which use the plastic strain as a failure criterion, setting the variable NL1 to 1 would flag plastic strain for nonlocal treatment. A sampling of other history variables that can be flagged for nonlocal treatment are listed in the table below. The value in

the third column in the table below corresponds to the history variable number as tabulated at <http://www.dynasupport.com/howtos/material/history-variables>. Note that the NL*n* value is the history variable number plus 1.

Material Model Name		*MAT_NONLOCAL NL <i>n</i> Value	History Variable Number
JOHNSON_COOK	15	5 (shells); 7 (solids)	4 (shells); 6 (solids)
PLASTICITY_WITH_DAMAGE	81	2	1
DAMAGE_1	104	4	3
DAMAGE_2	105	2	1
JOHNSON_HOLMQUIST_CONCRETE	111	2	1
GURSON	120	2	1

- Integration Points and Nonlocal Equations.** When applying the nonlocal equations to shell and thick shell elements, integration points lying in the same plane within the radius determined by the characteristic length are considered. Therefore, it is important to define the connectivity of the shell elements consistently within the part ID, so that, for example, the outer integration points lie on the same surface.
- Nonlocal Equations.** The equations and our implementation are based on the implementation by Worswick and Lalbin [1999] of the nonlocal theory to Pijaudier-Cabot and Bazant [1987]. Let Ω_r be the neighborhood of radius, L , of element e_r and $\{e_i\}_{i=1,\dots,N_r}$ the list of elements included in Ω_r , then

$$f_r = \dot{f}(x_r) = \frac{1}{W_r} \int_{\Omega_r} \dot{f}_{\text{local}} w(x_r - y) dy \approx \frac{1}{W_r} \sum_{i=1}^{N_r} \dot{f}_{\text{local}}^i w_{ri} V_i$$

where

$$W_r = W(x_r) = \int w(x_r - y) dy \approx \frac{1}{W_r} \sum_{i=1}^{N_r} w_{ri} V_i$$

$$w_{ri} = w(x_r - y_i) = \frac{1}{\left[1 + \left(\frac{\|x_r - y_i\|}{L}\right)^p\right]^q}$$

***MAT_ELASTIC_{OPTION}**

This is Material Type 1. This is an isotropic hypoelastic material and is available for beam, shell, and solid elements in LS-DYNA. A specialization of this material allows for modeling fluids.

Available options include:

<BLANK>

FLUID

such that the keyword cards appear as:

*MAT_ELASTIC or MAT_001

*MAT_ELASTIC_FLUID or MAT_001_FLUID

The fluid option is valid for solid elements only.

Card 1	1	2	3	4	5	6	7	8
Variable	MID	R0	E	PR	DA	DB	K	
Type	A	F	F	F	F	F	F	
Default	none	none	none	0.0	0.0	0.0	0.0	

Additional card for FLUID keyword option.

Card 2	1	2	3	4	5	6	7	8
Variable	VC	CP						
Type	F	F						
Default	none	10 ²⁰						

VARIABLE

DESCRIPTION

MID

Material identification. A unique number or label must be specified (see *PART).

VARIABLE	DESCRIPTION
RO	Mass density
E	Young's modulus
PR	Poisson's ratio
DA	Axial damping factor (used for Belytschko-Schwer beam, type 2, only).
DB	Bending damping factor (used for Belytschko-Schwer beam, type 2, only).
K	Bulk modulus (define for fluid option only).
VC	Tensor viscosity coefficient; values between .1 and .5 should be okay.
CP	Cavitation pressure (default = 10^{20}).

Remarks:

- Finite Strains.** This hypoelastic material model may not be stable for finite (large) strains. If large strains are expected, a hyperelastic material model, such as *MAT_002, would be more appropriate.
- Damping Factors.** The axial and bending damping factors are used to damp down numerical noise. The update of the force resultants, F_i , and moment resultants, M_i , includes the damping factors:

$$F_i^{n+1} = F_i^n + \left(1 + \frac{DA}{\Delta t}\right) \Delta F_i^{n+\frac{1}{2}}$$

$$M_i^{n+1} = M_i^n + \left(1 + \frac{DB}{\Delta t}\right) \Delta M_i^{n+\frac{1}{2}}$$

- Effective Plastic Strain.** The history variable labeled as "effective plastic strain" by LS-PrePost is volumetric strain in the case of *MAT_ELASTIC.
- Truss Elements and Damping Stress.** Truss elements include a damping stress given by

$$\sigma = 0.05\rho cL/\Delta t$$

where ρ is the mass density, c is the material wave speed, L is the element length, and Δt is the computation time step.

5. **FLUID Keyword Option.** For the FLUID keyword option, the bulk modulus field, K , must be defined, and both the Young's modulus and Poisson's ratio fields are ignored. Fluid-like behavior is obtained where the bulk modulus, K , and pressure rate, \dot{p} , are given by:

$$K = \frac{E}{3(1 - 2\nu)}$$

$$\dot{p} = -K\dot{\epsilon}_{ii}$$

and the shear modulus is set to zero. A tensor viscosity is used which acts only the deviatoric stresses, S_{ij}^{n+1} , given in terms of the damping coefficient as:

$$S_{ij}^{n+1} = VC \times \Delta L \times a \times \rho \dot{\epsilon}'_{ij}$$

where ΔL is a characteristic element length, a is the fluid bulk sound speed, ρ is the fluid density, and $\dot{\epsilon}'_{ij}$ is the deviatoric strain rate.

***MAT_OPTIONTROPIC_ELASTIC**

This is Material Type 2. This material is valid for modeling the elastic-orthotropic behavior of solids, shells, and thick shells. An anisotropic option is available for solid elements. For orthotropic solids an isotropic frictional damping is available.

Depending on the element type and solver, the implementation of this material model changes. See the theory manual for more details than the overview provided here. In the case of solids with an explicit solver or nonlinear implicit solver (meaning NSOLVR ≠ 1 on *CONTROL_IMPLICIT_SOLUTION), the model is the (hyperelastic) St. Venant-Kirchhoff model. The stress update is performed using the second Piola-Kirchhoff tensor. It is then transformed into the Cauchy stress for output. For shells (and this includes the 2D continuum elements, that is, shell types 13, 14, and 15), the model is implemented in the local coordinates of the shell as linear elasticity for explicit and nonlinear implicit. While the material response is linear, the shells themselves can undergo finite rotations consistent with applied forces. For the linear implicit solver, this material model is a linear elasticity model.

NOTE: This material does not support specification of a material angle, β_i , for each through-thickness integration point of a shell.

Available options include:

ORTHO

ANISO

such that the keyword cards appear:

*MAT_ORTHOTROPIC_ELASTIC or MAT_002 (4 cards follow)

*MAT_ANISOTROPIC_ELASTIC or MAT_002_ANIS (5 cards follow)

Card Summary:

Card 1a.1. This card is required for the ORTHO keyword option.

MID	RO	EA	EB	EC	PRBA	PRCA	PRCB
-----	----	----	----	----	------	------	------

Card 1a.2. This card is required for the ORTHO keyword option.

GAB	GBC	GCA	AOPT	G	SIGF		
-----	-----	-----	------	---	------	--	--

Card 1b.1. This card is required for the ANISO keyword option.

MID	RO	C11	C12	C22	C13	C23	C33
-----	----	-----	-----	-----	-----	-----	-----

Card 1b.2. This card is required for the ANISO keyword option.

C14	C24	C34	C44	C15	C25	C35	C45
-----	-----	-----	-----	-----	-----	-----	-----

Card 1b.3. This card is required for the ANISO keyword option.

C55	C16	C26	C36	C46	C56	C66	AOPT
-----	-----	-----	-----	-----	-----	-----	------

Card 2. This card is required.

XP	YP	ZP	A1	A2	A3	MACF	IHIS
----	----	----	----	----	----	------	------

Card 3. This card is required.

V1	V2	V3	D1	D2	D3	BETA	REF
----	----	----	----	----	----	------	-----

Data Card Definitions:

Orthotropic Card 1. Included for ORTHO keyword option.

Card 1a.1	1	2	3	4	5	6	7	8
Variable	MID	RO	EA	EB	EC	PRBA	PRCA	PRCB
Type	A	F	F	F	F	F	F	F

VARIABLE

DESCRIPTION

MID	Material identification. A unique number or label must be specified (see *PART).
RO	Mass density
EA	E_a , Young's modulus in a -direction
EB	E_b , Young's modulus in b -direction
EC	E_c , Young's modulus in c -direction (nonzero value required but not used for shells)
PRBA	ν_{ba} , Poisson's ratio in the ba direction

VARIABLE	DESCRIPTION
PRCA	ν_{ca} , Poisson's ratio in the <i>ca</i> direction
PRCB	ν_{cb} , Poisson's ratio in the <i>cb</i> direction

Orthotropic Card 2. Included for ORTHO keyword option.

Card 1a.2	1	2	3	4	5	6	7	8
Variable	GAB	GBC	GCA	AOPT	G	SIGF		
Type	F	F	F	F	F	F		

VARIABLE	DESCRIPTION
GAB	G_{ab} , shear modulus in the <i>ab</i> direction
GBC	G_{bc} , shear modulus in the <i>bc</i> direction
GCA	G_{ca} , shear modulus in the <i>ca</i> direction
AOPT	Material axes option (see Figure M2-1 and the Material Directions section): <p>EQ.0.0: Locally orthotropic with material axes determined by element nodes as shown in Figure M2-1. The a-direction is from node 1 to node 2 of the element. The b-direction is orthogonal to the a-direction and is in the plane formed by nodes 1, 2, and 4. When this option is used in two-dimensional planar and axisymmetric analysis, it is critical that the nodes in the element definition be numbered counterclockwise for this option to work correctly. For shells only, the material axes are then rotated about the normal vector to the surface of the shell by the angle BETA.</p> <p>EQ.1.0: Locally orthotropic with material axes determined by a point, <i>P</i>, in space and the global location of the element center; this is the a-direction. This option is for solid elements only.</p> <p>EQ.2.0: Globally orthotropic with material axes determined by vectors a and d input below, as with *DEFINE_COORDINATE_VECTOR</p>

VARIABLE**DESCRIPTION**

EQ.3.0: Locally orthotropic material axes determined by a vector \mathbf{v} and the normal vector to the plane of the element (see [Figure M2-1](#)). The plane of a solid element is the midsurface between the inner surface and outer surface defined by the first four nodes and the last four nodes of the connectivity of the element, respectively. Thus, for solid elements, AOPT = 3 is only available for hexahedrons. \mathbf{a} is determined by taking the cross product of \mathbf{v} with the normal vector, \mathbf{b} is determined by taking the cross product of the normal vector with \mathbf{a} , and \mathbf{c} is the normal vector. Then \mathbf{a} and \mathbf{b} are rotated about \mathbf{c} by an angle BETA. BETA may be set in the keyword input for the element or in the input for this keyword. Note that for solids, the material axes may be switched depending on the choice of MACF. The switch may occur before or after applying BETA depending on the value of MACF.

EQ.4.0: Locally orthotropic in a cylindrical coordinate system with the material axes determined by a vector \mathbf{v} , and an originating point, P , which define the centerline axis. This option is for solid elements only.

LT.0.0: |AOPT| is a coordinate system ID (see *DEFINE_COORDINATE_OPTION).

G Shear modulus for frequency independent damping. Frequency independent damping is based on a spring and slider in series. The critical stress for the slider mechanism is SIGF. For the best results, the value of G should be 250-1000 times greater than SIGF. This option applies only to solid elements.

SIGF Limit stress for frequency independent, frictional, damping

Anisotropic Card 1. Included for ANISO keyword option.

Card 1b.1	1	2	3	4	5	6	7	8
Variable	MID	R0	C11	C12	C22	C13	C23	C33
Type	A	F	F	F	F	F	F	F

Anisotropic Card 2. Included for ANISO keyword option.

Card 1b.2	1	2	3	4	5	6	7	8
Variable	C14	C24	C34	C44	C15	C25	C35	C45
Type	F	F	F	F	F	F	F	F

Anisotropic Card 3. Included for ANISO keyword option.

Card 1b.3	1	2	3	4	5	6	7	8
Variable	C55	C16	C26	C36	C46	C56	C66	AOPT
Type	F	F	F	F	F	F	F	F

VARIABLE**DESCRIPTION**

MID	Material identification. A unique number or label must be specified (see *PART).
RO	Mass density
C11	The 1, 1 term in the 6×6 anisotropic constitutive matrix. Note that 1 corresponds to the <i>a</i> material direction
C12	The 1, 2 term in the 6×6 anisotropic constitutive matrix. Note that 2 corresponds to the <i>b</i> material direction
⋮	⋮
C66	The 6, 6 term in the 6×6 anisotropic constitutive matrix.
AOPT	Material axes option (see Figure M2-1 and the Material Directions section):

VARIABLE	DESCRIPTION
EQ.0.0:	Locally orthotropic with material axes determined by element nodes as shown in Figure M2-1 . The a -direction is from node 1 to node 2 of the element. The b -direction is orthogonal to the a -direction and is in the plane formed by nodes 1, 2, and 4. When this option is used in two-dimensional planar and axisymmetric analysis, it is critical that the nodes in the element definition be numbered counterclockwise for this option to work correctly. For shells only, the material axes are then rotated about the normal vector to the surface of the shell by the angle BETA.
EQ.1.0:	Locally orthotropic with material axes determined by a point, <i>P</i> , in space and the global location of the element center; this is the a -direction. This option is for solid elements only.
EQ.2.0:	Globally orthotropic with material axes determined by vectors a and d input below, as with *DEFINE_COORDINATE_VECTOR
EQ.3.0:	Locally orthotropic material axes determined by a vector v and the normal vector to the plane of the element (see Figure M2-1). The plane of a solid element is the midsurface between the inner surface and outer surface defined by the first four nodes and the last four nodes of the connectivity of the element, respectively. Thus, for solid elements, AOPT = 3 is only available for hexahedrons. a is determined by taking the cross product of v with the normal vector, b is determined by taking the cross product of the normal vector with a , and c is the normal vector. Then a and b are rotated about c by an angle BETA. BETA may be set in the keyword input for the element or in the input for this keyword. Note that for solids, the material axes may be switched depending on the choice of MACF. The switch may occur before or after applying BETA depending on the value of MACF.
EQ.4.0:	Locally orthotropic in a cylindrical coordinate system with the material axes determined by a vector v , and an originating point, <i>P</i> , which define the centerline axis. This option is for solid elements only.
LT.0.0:	AOPT is a coordinate system ID (see *DEFINE_COORDINATE_OPTION).

Local Coordinate System Card 1. Required for all keyword options.

Card 2	1	2	3	4	5	6	7	8
Variable	XP	YP	ZP	A1	A2	A3	MACF	IHIS
Type	F	F	F	F	F	F	I	I

VARIABLE

DESCRIPTION

XP, YP, ZP

Coordinates of point *P* for AOPT = 1 and 4

A1, A2, A3

Components of vector **a** for AOPT = 2

MACF

Material axes change flag for solid elements:

EQ.-4: Switch material axes *b* and *c* before BETA rotation

EQ.-3: Switch material axes *a* and *c* before BETA rotation

EQ.-2: Switch material axes *a* and *b* before BETA rotation

EQ.1: No change, default

EQ.2: Switch material axes *a* and *b* after BETA rotation

EQ.3: Switch material axes *a* and *c* after BETA rotation

EQ.4: Switch material axes *b* and *c* after BETA rotation

Figure M2-2 indicates when LS-DYNA applies MACF when finding the final material axes. If BETA on *ELEMENT_SOLID_{OPTION} is defined, then that BETA rotates the axes for all AOPT options. Otherwise, unless AOPT = 3, the material axes will be switched as specified by MACF, but no BETA rotation will occur. If AOPT = 3, then BETA input on Card 3 rotates the axes.

IHIS

Flag for anisotropic stiffness terms initialization (for solid elements only):

EQ.0: C11, C12, ... from Cards 1b.1, 1b.2, and 1.b3 are used.

EQ.1: C11, C12, ... are initialized with history data from *INITIAL_STRESS_SOLID.

Local Coordinate System Card 2. Required for all keyword options.

Card 3	1	2	3	4	5	6	7	8
Variable	V1	V2	V3	D1	D2	D3	BETA	REF
Type	F	F	F	F	F	F	F	F

VARIABLE**DESCRIPTION**

V1, V2, V3

Components of vector **v** for AOPT = 3 and 4.

D1, D2, D3

Components of vector **d** for AOPT = 2.

BETA

Angle in degrees of a material rotation about the c-axis, available for AOPT = 0 (shells and tshells only) and AOPT = 3 (all element types). This angle may be overridden on the element card; see *ELEMENT_SHELL_BETA, *ELEMENT_TSHELL_BETA, and *ELEMENT_SOLID_ORTHO.

REF

Flag to use reference geometry specified with *INITIAL_FOAM_REFERENCE_GEOMETRY to initialize the stress tensor.

EQ.0.0: Off

EQ.1.0: On

Remarks:

1. **Stress-Strain Material Law.** The material law that relates stresses to strains is defined as:

$$\mathbf{C} = \mathbf{T}^T \mathbf{C}_L \mathbf{T}$$

where \mathbf{T} is a transformation matrix, and \mathbf{C}_L is the constitutive matrix defined in terms of the material constants of the orthogonal material axes, $\{\mathbf{a}, \mathbf{b}, \mathbf{c}\}$. The inverse of \mathbf{C}_L for the orthotropic case is defined as:

$$\mathbf{C}_L^{-1} = \begin{bmatrix} \frac{1}{E_a} & -\frac{\nu_{ba}}{E_b} & -\frac{\nu_{ca}}{E_c} & 0 & 0 & 0 \\ -\frac{\nu_{ab}}{E_a} & \frac{1}{E_b} & -\frac{\nu_{cb}}{E_c} & 0 & 0 & 0 \\ -\frac{\nu_{ac}}{E_a} & -\frac{\nu_{bc}}{E_b} & \frac{1}{E_c} & 0 & 0 & 0 \\ 0 & 0 & 0 & \frac{1}{G_{ab}} & 0 & 0 \\ 0 & 0 & 0 & 0 & \frac{1}{G_{bc}} & 0 \\ 0 & 0 & 0 & 0 & 0 & \frac{1}{G_{ca}} \end{bmatrix}$$

where,

$$\frac{\nu_{ab}}{E_a} = \frac{\nu_{ba}}{E_b} \quad , \quad \frac{\nu_{ca}}{E_c} = \frac{\nu_{ac}}{E_a} \quad , \quad \frac{\nu_{cb}}{E_c} = \frac{\nu_{bc}}{E_b} \quad .$$

2. **Frequency Independent Damping.** The frequency independent damping is obtained by having a spring and slider in series as shown in the following sketch:

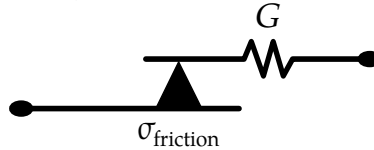

This option applies only to orthotropic solid elements and affects only the deviatoric stresses.

3. **Poisson's Ratio.** PRBA is the minor Poisson's ratio if $EA > EB$, and the major Poisson's ratio will be equal to $PRBA(EA/EB)$. If $EB > EA$, then PRBA is the major Poisson's ratio. PRCA and PRCB are similarly defined. They are the minor Poisson's ratio if $EA > EC$ or $EB > EC$, and the major Poisson's ratio if the $EC > EA$ or $EC > EB$.

Care should be taken when using material parameters from third party products regarding the directional indices a, b and c , as they may differ from the definition used in LS-DYNA.

4. **History Variables.** This material has the following history variables. Note that for shells and thick shells with element formulations 1, 2, and 6 the history variable labeled as "effective plastic strain" by LS-PrePost is stiffness component C_{11} .

History Variable #	Description (solids and thick shells 3, 5, and 7)	Description (shells and thick shells 1, 2 and 6)
1	Deformation gradient component F_{11}	Stiffness component C_{12}
2	Deformation gradient component F_{12}	Stiffness component C_{13}
3	Deformation gradient component F_{13}	Stiffness component C_{14}
4	Deformation gradient component F_{21}	Stiffness component C_{22}
5	Deformation gradient component F_{22}	Stiffness component C_{23}
6	Deformation gradient component F_{23}	Stiffness component C_{24}
7	Deformation gradient component F_{31}	Stiffness component C_{33}
8	Deformation gradient component F_{32}	Stiffness component C_{34}
9	Deformation gradient component F_{33}	Stiffness component C_{44}
10		Stiffness component C_{55}
11		Stiffness component C_{56}
12		Stiffness component C_{66}

Material Directions:

We will give an overview of how LS-DYNA finds the principal material directions for solid and shell elements for this material and other anisotropic materials based on the input. We will call the material coordinate system the $\{\mathbf{a}, \mathbf{b}, \mathbf{c}\}$ coordinate system. The AOPT options illustrated in [Figure M2-1](#) define the preliminary $\{\mathbf{a}, \mathbf{b}, \mathbf{c}\}$ system for all elements of the parts that use the material, but this is not the final material direction. The $\{\mathbf{a}, \mathbf{b}, \mathbf{c}\}$ system defined by the AOPT options may be offset by a final rotation about the \mathbf{c} -axis. The offset angle we call BETA. Note that *ELEMENT_SOLID_ORTHO and *ELEMENT_SHELL_MCID allow you to set the preliminary $\{\mathbf{a}, \mathbf{b}, \mathbf{c}\}$ coordinate system for individual solid and shell elements, instead of using the preliminary system created with AOPT. [Figures M2-2](#) and [M2-3](#) give the flow chart for finding the final material direction based on the input to the *MAT keyword and the *ELEMENT keyword. As indicated in the figures, the orientation of the final material axes is updated continuously through the simulation as the element moves and deforms, in accordance with the invariant numbering scheme (INN in *CONTROL_ACCURACY).

For solid elements, the BETA angle is specified in one of two ways. When using AOPT = 3, the BETA parameter defines the offset angle for all elements that use the material. The BETA parameter on *MAT has no meaning for the other AOPT options. Alternatively, a BETA angle can be defined for individual solid elements as described in Remark 5 for *ELEMENT_SOLID_ORTHO. The BETA angle set using the ORTHO option is available for all values of AOPT, and it overrides the BETA angle on the *MAT card for AOPT = 3 (see Figure M2-2). Note that when the BETA angle is applied in either case depends on the value of MACF (if available) of the *MAT keyword. With MACF two of the material directions may be switched.

There are two fundamental differences between shell and solid element orthotropic materials. (In the following discussion, tshell elements fall into the “shell” category.) First, the **c**-direction is always normal to a shell element such that the **a** and **b**-directions are within the plane of the element. Second, for some anisotropic materials, shell elements may have unique fiber directions within each layer through the thickness of the element so that a layered composite can be modeled with a single element.

As a result of the **c**-direction being defined by the element normal, MACF does not apply to shells. Similarly, AOPT = 1 and AOPT = 4 are not available for shells. Also, AOPT = 2 requires only the vector **a** be specified since **d** is not used. The shell procedure projects the inputted **a**-direction onto each element surface.

Note that when AOPT = 0 is used in two-dimensional planar and axisymmetric analysis, it is critical that the nodes in the element definition be numbered counterclockwise for this option to work correctly.

Similar to solid elements, the {**a**, **b**, **c**} coordinate system determined by AOPT is then modified by a rotation about the **c**-axis which we will call ϕ . For those materials that allow a unique rotation angle for each integration point through the element thickness, the rotation angle is calculated by

$$\phi_i = \beta + \beta_i ,$$

where β is a rotation for the element, and β_i is the rotation for the i^{th} layer of the element. The β angle can be input using the BETA parameter on the *MAT data but will be overridden for individual elements if *ELEMENT_SHELL_BETA (*ELEMENT_TSHELL_BETA) is used. The β_i angles are input using the ICOMP = 1 option of *SECTION_SHELL (*SECTION_TSHELL) or with *PART_COMPOSITE (*PART_COMPOSITE_TSHELL). If β or β_i is omitted, they are assumed to be zero.

All anisotropic shell materials have the BETA parameter on the *MAT card available for both AOPT = 0 and AOPT = 3, except for materials 91 and 92 which have it available (but called FANG instead of BETA) for AOPT = 0, 2, and 3.

All anisotropic shell materials allow an angle for each integration point through the thickness, β_i , *except for* materials 2, 86, 91, 92, 117, 130, 170, 172, and 194.

Illustration of AOPT: Figure M2-1

AOPT = 0.0

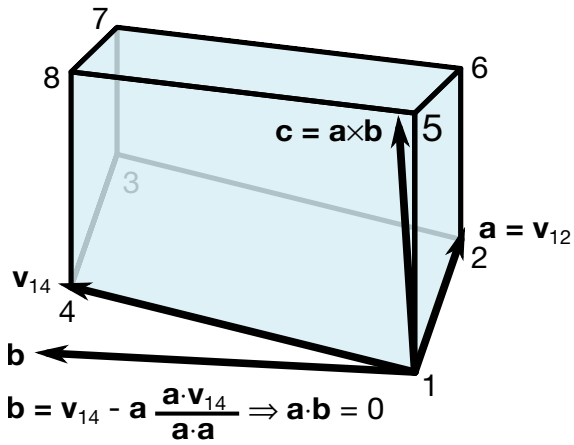

AOPT = 1.0 (solid only)

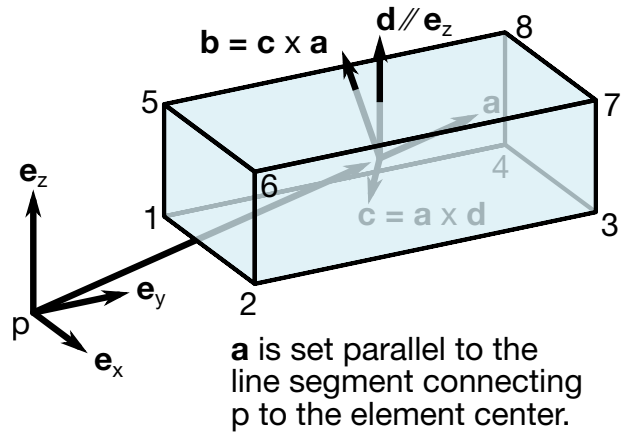

AOPT = 2.0 (solid)

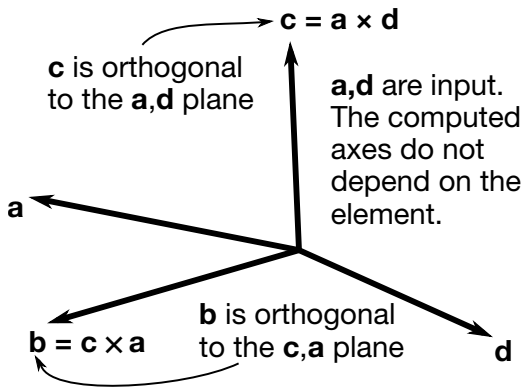

AOPT = 2.0 (shell)

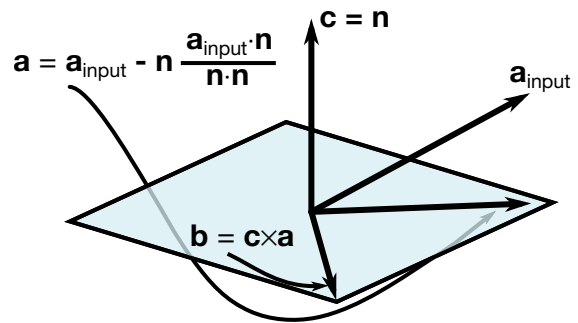

AOPT = 3.0

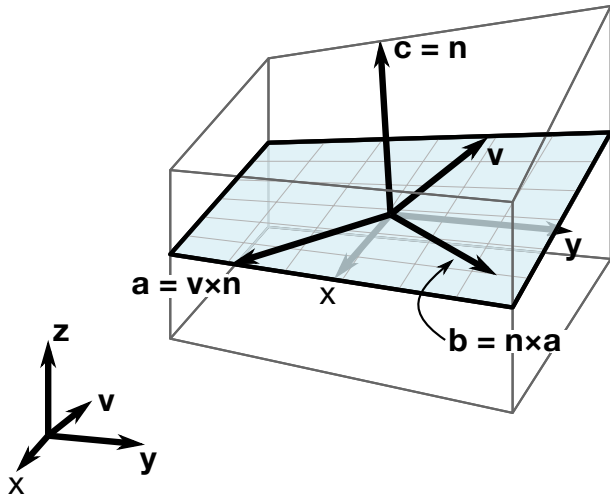

AOPT = 4.0 (solid only)

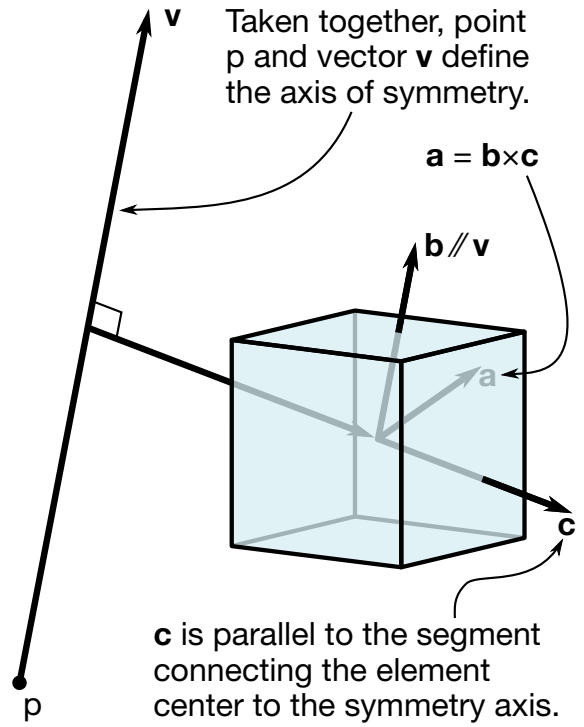

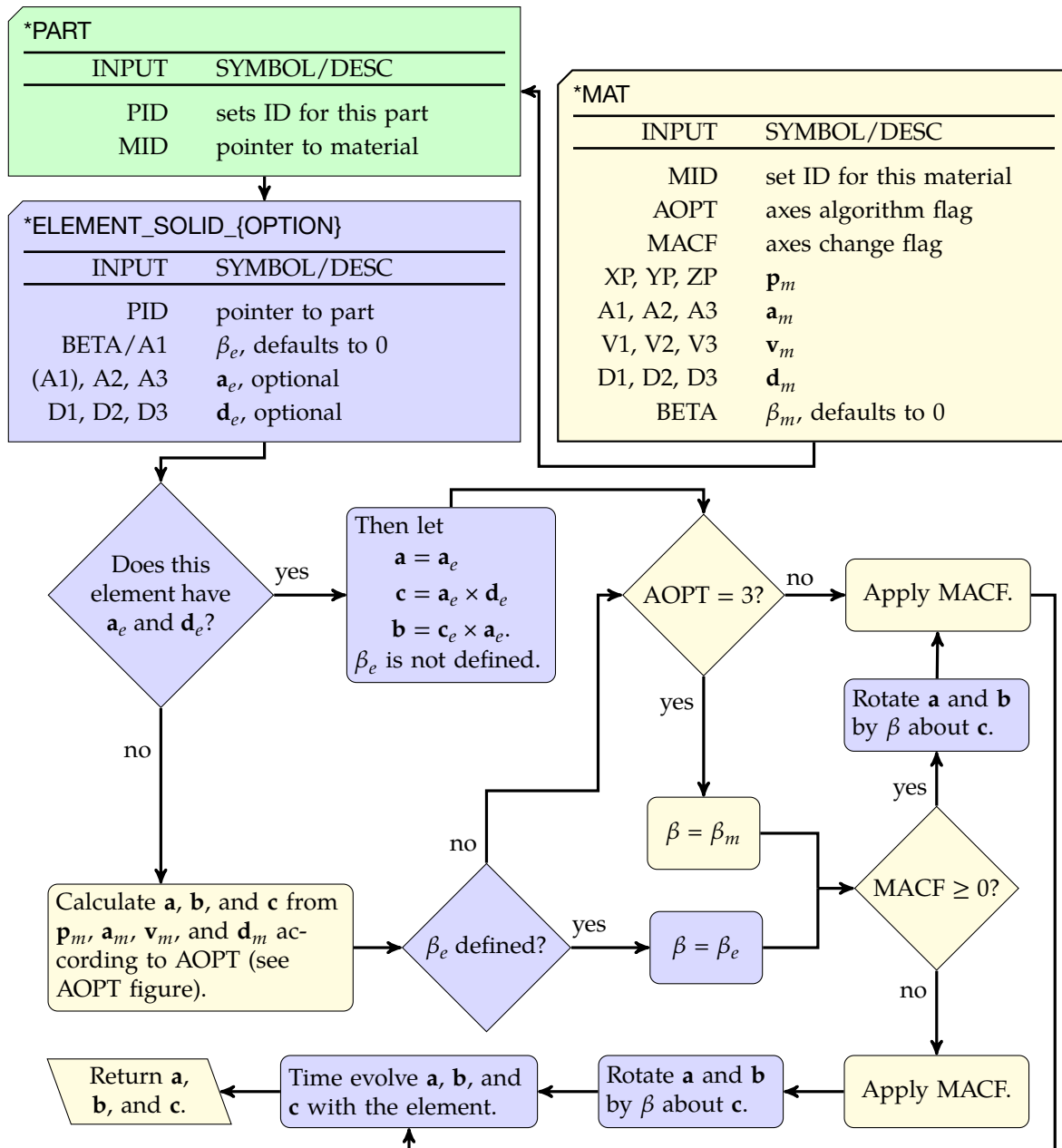

Figure M2-2. Flowchart showing how for each solid element LS-DYNA determines the vectors $\{\mathbf{a}, \mathbf{b}, \mathbf{c}\}$ from the input.

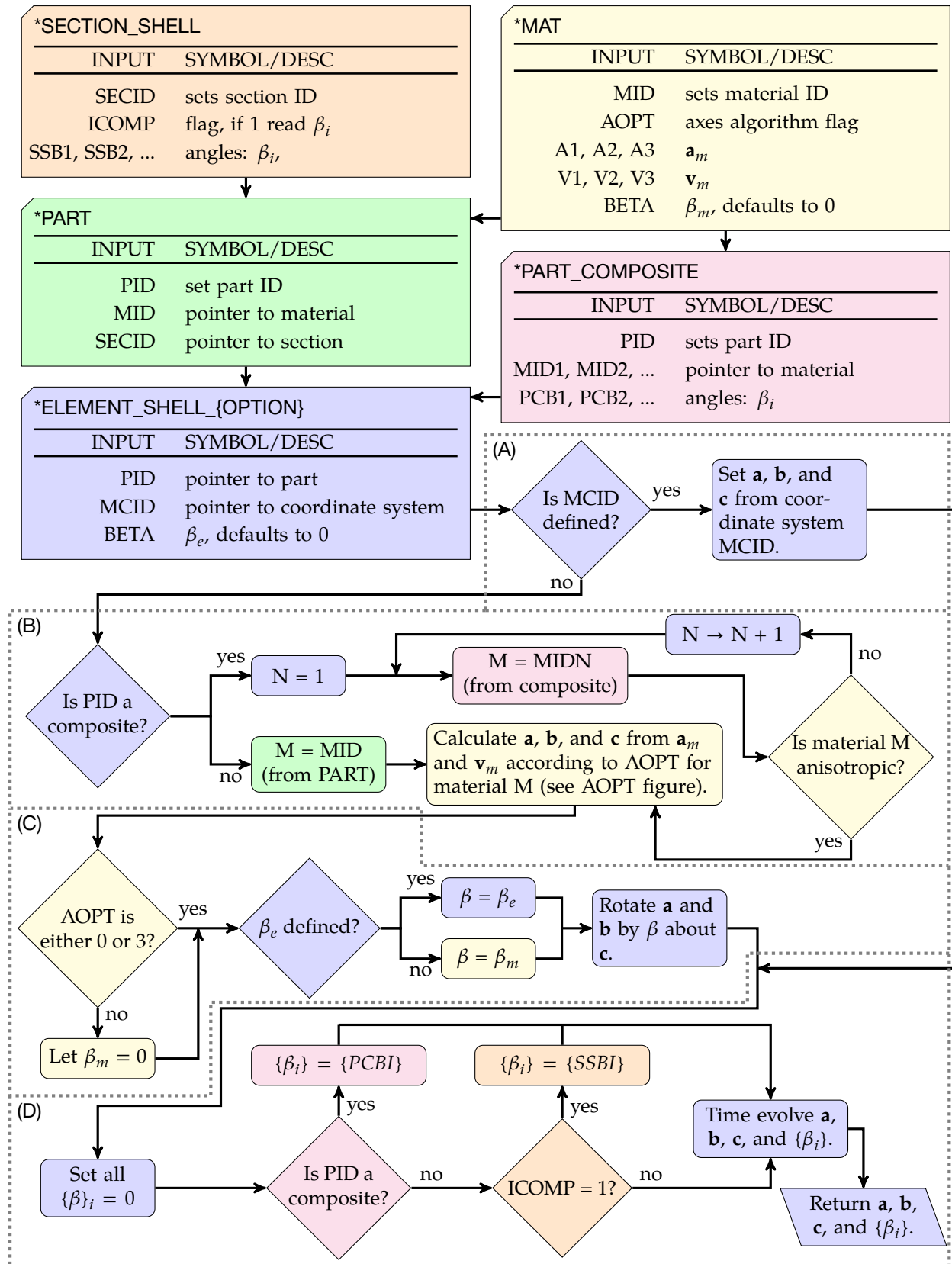

Figure M2-3. Flowchart for shells: (a) check for coordinate system ID; (b) process AOPT; (c) determine β ; and (d) for each layer determine β_i .

***MAT_PLASTIC_KINEMATIC**

This is Material Type 3. This model is suited for modelling isotropic and kinematic hardening plasticity with the option of including rate effects. It is a very cost-effective model and is available for beam (Hughes-Liu and Truss), shell, and solid elements.

Card 1	1	2	3	4	5	6	7	8
Variable	MID	RO	E	PR	SIGY	ETAN	BETA	
Type	A	F	F	F	F	F	F	
Default	none	none	none	none	none	0.0	0.0	

Card 2	1	2	3	4	5	6	7	8
Variable	SRC	SRP	FS	VP				
Type	F	F	F	F				
Default	0.0	0.0	10 ²⁰	0.0				

VARIABLE**DESCRIPTION**

MID	Material identification. A unique number or label must be specified (see *PART).
RO	Mass density
E	Young's modulus
PR	Poisson's ratio
SIGY	Yield stress
ETAN	Tangent modulus; see Figure M3-1 .
BETA	Hardening parameter, $0 < \beta' < 1$. See Remark 2 .
SRC	Strain rate parameter, C , for the Cowper Symonds strain rate model; see Remark 1 . If zero, rate effects are not considered.

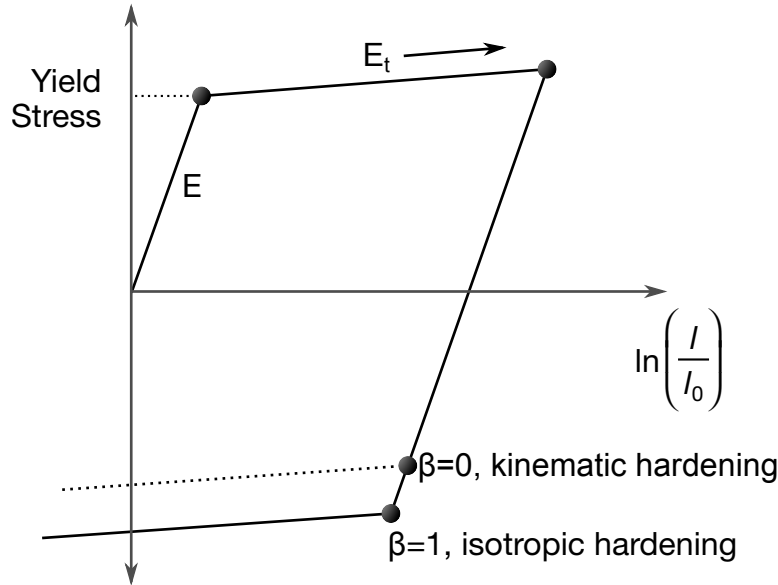

Figure M3-1. Elastic-plastic behavior with kinematic and isotropic hardening where l_0 and l are undeformed and deformed lengths of uniaxial tension specimen. E_t is the slope of the bilinear stress strain curve.

VARIABLE	DESCRIPTION
SRP	Strain rate parameter, p , for Cowper Symonds strain rate model; see Remark 1 . If zero, rate effects are not considered.
FS	Effective plastic strain for eroding elements
VP	Formulation for rate effects: EQ.0.0: scale yield stress (default) EQ.1.0: viscoplastic formulation (recommended)

Remarks:

- Cowper Symonds Strain Rate Model.** Strain rate is accounted for using the Cowper and Symonds model which scales the yield stress with the factor

$$1 + \left(\frac{\dot{\epsilon}}{C}\right)^{1/p}$$

where $\dot{\epsilon}$ is the strain rate. A fully viscoplastic formulation is optional which incorporates the Cowper and Symonds formulation within the yield surface. To ignore strain rate effects set both SRC and SRP to zero.

- Hardening Parameter.** Kinematic, isotropic, or a combination of kinematic and isotropic hardening may be specified by varying β' between 0 and 1. For β' equal

to 0 and 1, respectively, kinematic and isotropic hardening are obtained as shown in [Figure M3-1](#). For isotropic hardening, $\beta' = 1$, Material Model 12, *MAT_ISOTROPIC_ELASTIC_PLASTIC, requires less storage and is more efficient. Whenever possible, Material 12 is recommended for solid elements, but for shell elements, it is less accurate and thus Material 12 is not recommended in this case.

3. **History Variables.** This material has the following extra history variables.

History Variable #	Description
1	Back stress component xx
2	Back stress component yy
3	Back stress component xy
4	Back stress component yz
5	Back stress component zx

***MAT_ELASTIC_PLASTIC_THERMAL**

This is Material Type 4. Temperature dependent material coefficients can be defined with this material. A maximum of eight temperatures with the corresponding data can be defined, but a minimum of two points is required. When this material type is used, it is necessary to define nodal temperatures by activating a coupled analysis or by using another option to define the temperatures, such as *LOAD_THERMAL_LOAD_CURVE, or *LOAD_THERMAL_VARIABLE.

Card 1	1	2	3	4	5	6	7	8
Variable	MID	RO						
Type	A	F						

Card 2	1	2	3	4	5	6	7	8
Variable	T1	T2	T3	T4	T5	T6	T7	T8
Type	F	F	F	F	F	F	F	F

Card 3	1	2	3	4	5	6	7	8
Variable	E1	E2	E3	E4	E5	E6	E7	E8
Type	F	F	F	F	F	F	F	F

Card 4	1	2	3	4	5	6	7	8
Variable	PR1	PR2	PR3	PR4	PR5	PR6	PR7	PR8
Type	F	F	F	F	F	F	F	F

Card 5	1	2	3	4	5	6	7	8
Variable	ALPHA1	ALPHA2	ALPHA3	ALPHA4	ALPHA5	ALPHA6	ALPHA7	ALPHA8
Type	F	F	F	F	F	F	F	F

Card 6	1	2	3	4	5	6	7	8
Variable	SIGY1	SIGY2	SIGY3	SIGY4	SIGY5	SIGY6	SIGY7	SIGY8
Type	F	F	F	F	F	F	F	F

Card 7	1	2	3	4	5	6	7	8
Variable	ETAN1	ETAN2	ETAN3	ETAN4	ETAN5	ETAN6	ETAN7	ETAN8
Type	F	F	F	F	F	F	F	F

VARIABLE**DESCRIPTION**

MID	Material identification. A unique number or label must be specified (see *PART).
RO	Mass density
T_i	Temperatures. The minimum required is 2 while the maximum allowed is 8.
E_i	Corresponding Young's modulus at temperature T_i
PR_i	Corresponding Poisson's ratio at temperature T_i
$ALPHA_i$	Corresponding coefficient of thermal expansion at temperature T_i
$SIGY_i$	Corresponding yield stress at temperature T_i
$ETAN_i$	Corresponding plastic hardening modulus at temperature T_i

Remarks:

1. **Material Model.** The stress update for this material follows the standard approach for hypo-elastoplasticity, using the Jaumann rate for objectivity. The rate of Cauchy stress σ can be expressed as

$$\dot{\sigma} = \mathbf{C}(\dot{\epsilon} - \dot{\epsilon}_T - \dot{\epsilon}_p) + \dot{\mathbf{C}}\mathbf{C}^{-1}\sigma ,$$

where \mathbf{C} is the temperature dependent isotropic elasticity tensor, $\dot{\epsilon}$ is the rate-of-deformation, $\dot{\epsilon}_T$ is the thermal strain rate, and $\dot{\epsilon}_p$ is the plastic strain rate. The coefficient of thermal expansion is defined as the instantaneous value. Thus, the thermal strain rate becomes

$$\dot{\epsilon}_T = \alpha \dot{T} \mathbf{I}$$

where α is the temperature dependent thermal expansion coefficient, \dot{T} is the rate of temperature and \mathbf{I} is the identity tensor. Associated von Mises plasticity is adopted, resulting in

$$\dot{\epsilon}_p = \dot{\epsilon}_p \frac{3\mathbf{s}}{2\bar{\sigma}}$$

where $\dot{\epsilon}_p$ is the effective plastic strain rate, \mathbf{s} is the deviatoric stress tensor, and $\bar{\sigma}$ is the von Mises effective stress. The last term accounts for stress changes due to change in stiffness with respect to temperature, using the total elastic strain defined as $\epsilon_e = \mathbf{C}^{-1}\sigma$. As a way to intuitively understand this contribution, the special case of small displacement elasticity neglecting everything but the temperature dependent elasticity parameters gives

$$\dot{\sigma} = \frac{d}{dt}(\mathbf{C}\epsilon) ,$$

showing that the stress may change without any change in strain.

2. **Model Requirements and Restrictions.** At least two temperatures and their corresponding material properties must be defined. The analysis will be terminated if a material temperature falls outside the range defined in the input. If a thermo-elastic material is considered, do not define SIGY and ETAN.
3. **History Variables.** This material has the following extra history history variables.

History Variable #	Description
1	Reference temperature
3	Current temperature

***MAT_SOIL_AND_FOAM**

This is Material Type 5. It is a relatively simple material model for representing soil, concrete, or crushable foam. A table can be defined if thermal effects are considered in the pressure as a function of volumetric strain behavior.

Card 1	1	2	3	4	5	6	7	8
Variable	MID	RO	G	KUN	A0	A1	A2	PC
Type	A	F	F	F	F	F	F	F

Card 2	1	2	3	4	5	6	7	8
Variable	VCR	REF	LCID					
Type	F	F	F					

Card 3	1	2	3	4	5	6	7	8
Variable	EPS1	EPS2	EPS3	EPS4	EPS5	EPS6	EPS7	EPS8
Type	F	F	F	F	F	F	F	F

Card 4	1	2	3	4	5	6	7	8
Variable	EPS9	EPS10						
Type	F	F						

Card 5	1	2	3	4	5	6	7	8
Variable	P1	P2	P3	P4	P5	P6	P7	P8
Type	F	F	F	F	F	F	F	F

Card 6	1	2	3	4	5	6	7	8
Variable	P9	P10						
Type	F	F						

VARIABLE**DESCRIPTION**

MID	Material identification. A unique number or label must be specified (see *PART).
RO	Mass density
G	Shear modulus
KUN	Bulk modulus for unloading used for VCR = 0.0
A0	Yield function constant for plastic yield function below
A1	Yield function constant for plastic yield function below
A2	Yield function constant for plastic yield function below
PC	Pressure cutoff for tensile fracture (< 0)
VCR	Volumetric crushing option: EQ.0.0: on EQ.1.0: loading and unloading paths are the same
REF	Use reference geometry to initialize the pressure. The reference geometry is defined by the keyword: *INITIAL_FOAM_REFERENCE_GEOMETRY. This option does not initialize the deviatoric stress state. EQ.0.0: off EQ.1.0: on
LCID	Load curve ID for compressive pressure (ordinate) as a function of volumetric strain (abscissa). If LCID is defined, then the curve is used instead of the input for EPS_i and P_i . It makes no difference whether the values of volumetric strain in the curve are input as positive or negative since internally, a negative sign is applied to the absolute value of each abscissa entry. If LCID refers to a table, the response is extended to being temperature dependent.

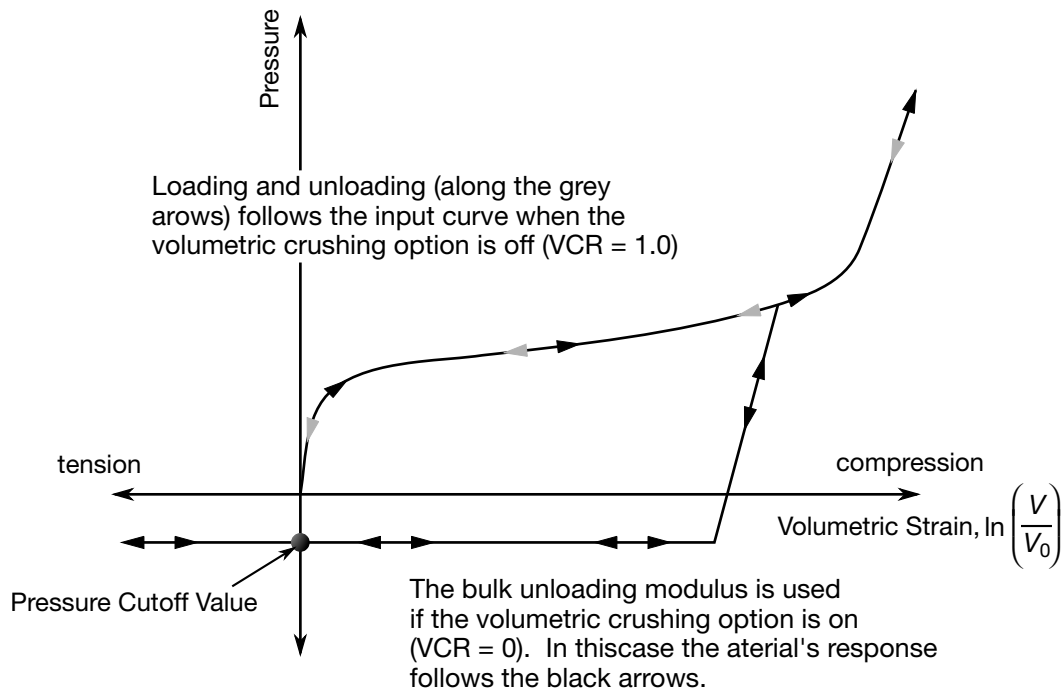

Figure M5-1. Pressure as a function of volumetric strain curve for soil and crushable foam model. The volumetric strain is given by the natural logarithm of the relative volume, V .

VARIABLE	DESCRIPTION
EPS1, ...	Volumetric strain values in pressure as a function of volumetric strain curve (see Remarks below). A maximum of 10 values including 0.0 are allowed and a minimum of 2 values are necessary. If EPS1 is not 0.0, then a point (0.0,0.0) will be automatically generated and a maximum of nine values may be input.
P1, P2, ..., PN	Pressures corresponding to volumetric strain values given on Cards 3 and 4.

Remarks:

- Variable Definitions.** Pressure is positive in compression. Volumetric strain is given by the natural log of the relative volume and is negative in compression. Relative volume is a ratio of the current volume to the initial volume at the start of the calculation. The tabulated data should be given in order of increasing compression. If the pressure drops below the cutoff value specified, it is reset to that value. For a detailed description we refer to Kreig [1972].
- Yield Strength.** The deviatoric perfectly plastic yield function, ϕ , is described in terms of the second invariant J_2 ,

$$J_2 = \frac{1}{2} s_{ij}s_{ij} ,$$

pressure, p , and constants a_0 , a_1 , and a_2 as:

$$\phi = J_2 - [a_0 + a_1p + a_2p^2] .$$

On the yield surface $J_2 = \frac{1}{3}\sigma_y^2$ where σ_y is the uniaxial yield stress, that is,

$$\sigma_y = [3(a_0 + a_1p + a_2p^2)]^{1/2} .$$

There is no strain hardening on this surface.

To eliminate the pressure dependence of the yield strength, set:

$$a_1 = a_2 = 0 \quad \text{and} \quad a_0 = \frac{1}{3}\sigma_y^2 .$$

This approach is useful when a von Mises type elastic-plastic model is desired for use with the tabulated volumetric data.

3. **Equivalent Plastic Strain.** The history variable labeled as “plastic strain” by LS-PrePost is actually plastic volumetric strain. Note that when VCR = 1.0, plastic volumetric strain is zero.

***MAT_VISCOELASTIC**

This is Material Type 6. This model is for the modeling of viscoelastic behavior for beams (Hughes-Liu), shells, and solids. Also see *MAT_GENERAL_VISCOELASTIC for a more general formulation.

Card 1	1	2	3	4	5	6	7	8
Variable	MID	RO	BULK	G0	GI	BETA		
Type	A	F	F	F	F	F		

VARIABLE**DESCRIPTION**

MID	Material identification. A unique number or label must be specified (see *PART).
RO	Mass density
BULK	Elastic bulk modulus. LT.0.0: BULK is a load curve of bulk modulus as a function of temperature.
G0	Short-time shear modulus, G_0 ; see the Remarks below. LT.0.0: G0 is a load curve of short-time shear modulus as a function of temperature.
GI	Long-time (infinite) shear modulus, G_∞ . LT.0.0: GI is a load curve of long-time shear modulus as a function of temperature.
BETA	Decay constant. LT.0.0: BETA is a load curve of decay constant as a function of temperature.

Remarks:

The shear relaxation behavior is described by [Hermann and Peterson, 1968]:

$$G(t) = G_\infty + (G_0 - G_\infty) \exp(-\beta t) .$$

A Jaumann rate formulation is used:

$$\overset{\nabla}{\sigma}'_{ij} = 2 \int_0^t G(t - \tau) D'_{ij}(\tau) d\tau ,$$

where the prime denotes the deviatoric part of the stress rate, $\overset{\nabla}{\sigma}'_{ij}$, and the strain rate, D_{ij} .

*MAT_BLATZ-KO_RUBBER

This is Material Type 7. This one parameter material allows the modeling of nearly incompressible continuum rubber. The Poisson's ratio is fixed to 0.463.

Card 1	1	2	3	4	5	6	7	8
Variable	MID	RO	G	REF				
Type	A	F	F	F				

VARIABLE**DESCRIPTION**

MID	Material identification. A unique number or label must be specified (see *PART).
RO	Mass density
G	Shear modulus
REF	Use reference geometry to initialize the stress tensor. The reference geometry is defined by the keyword: *INITIAL_FOAM_REFERENCE_GEOMETRY (see there for more details). EQ.0.0: off EQ.1.0: on

Remarks:

1. **Stress-Strain Relationship.** The strain energy density potential for the Blatz-Ko rubber is

$$W(\mathbf{C}) = \frac{G}{2} \left[I_1 - 3 + \frac{1}{\beta} (I_3^{-\beta} - 1) \right]$$

where G is the shear modulus, I_1 and I_3 are the first and third invariants of the right Cauchy-Green tensor $\mathbf{C} = \mathbf{F}^T \mathbf{F}$, and

$$\beta = \frac{\nu}{1 - 2\nu} .$$

The second Piola-Kirchhoff stress is computed as

$$\mathbf{S} = 2 \frac{\partial W}{\partial \mathbf{C}} = G \left[\mathbf{I} - I_3^{-\beta} \mathbf{C}^{-1} \right]$$

from which the Cauchy stress is obtained by a push-forward from the reference to current configuration divided by the relative volume $J = \det(\mathbf{F})$,

$$\boldsymbol{\sigma} = \frac{1}{J} \mathbf{F} \mathbf{S} \mathbf{F}^T = \frac{G}{J} [\mathbf{B} - I_3^{-\beta} \mathbf{I}].$$

Here we use $\mathbf{B} = \mathbf{F} \mathbf{F}^T$ to denote the left Cauchy-Green tensor, and Poisson's ratio, ν , above is set internally to $\nu = 0.463$; also see Blatz and Ko [1962].

- History Variables.** For solids, the 9 history variables store the deformation gradient, whereas for shells, the gradient is stored in the slot for effective plastic strain along with the first 8 history variables (the 9th stores in internal flag). If a dynain file is created using `INTERFACE_SPRINGBACK_LSDYNA`, then `NSHV` should be set to 9 so that the `*INITIAL_STRESS_SHELL` cards have the correct deformation gradient from which the stresses are to be calculated.

*MAT_HIGH_EXPLOSIVE_BURN

This is Material Type 8. It allows the modeling of the detonation of a high explosive. In addition, an equation of state must be defined. See Wilkins [1969] and Giroux [1973].

Card 1	1	2	3	4	5	6	7	8
Variable	MID	RO	D	PCJ	BETA	K	G	SIGY
Type	A	F	F	F	F	F	F	F

VARIABLE**DESCRIPTION**

MID	Material identification. A unique number or label must be specified (see *PART).
RO	Mass density
D	Detonation velocity
PCJ	Chapman-Jouget pressure
BETA	Beta burn flag (see remarks below): EQ.0.0: beta and programmed burn EQ.1.0: beta burn only EQ.2.0: programmed burn only
K	Bulk modulus (BETA = 2.0 only)
G	Shear modulus (BETA = 2.0 only)
SIGY	σ_y , yield stress (BETA = 2.0 only)

Remarks:

Burn fractions, F , which multiply the equations of states for high explosives, control the release of chemical energy for simulating detonations. At any time, the pressure in a high explosive element is given by:

$$p = F p_{\text{eos}}(V, E),$$

where p_{eos} is the pressure from the equation of state (either types 2, 3, or 14), V is the relative volume, and E is the internal energy density per unit initial volume.

In the initialization phase, a lighting time, t_l , is computed for each element by dividing the distance from the detonation point to the center of the element by the detonation velocity, D . If multiple detonation points are defined, the closest detonation point determines t_l . The burn fraction F is taken as the maximum,

$$F = \max(F_1, F_2) ,$$

where

$$F_1 = \begin{cases} \frac{2 (t - t_l) D A_{e_{\max}}}{3v_e} & \text{if } t > t_l \\ 0 & \text{if } t \leq t_l \end{cases}$$

$$F_2 = \beta = \frac{1 - V}{1 - V_{CJ}}$$

where V_{CJ} is the Chapman-Jouguet relative volume and t is current time. If F exceeds 1, it is reset to 1. This calculation of the burn fraction usually requires several time steps for F to reach unity, thereby spreading the burn front over several elements. After reaching unity, F is held constant. This burn fraction calculation is based on work by Wilkins [1964] and is also discussed by Giroux [1973].

If the beta burn option is used, BETA = 1.0, any volumetric compression will cause detonation and

$$F = F_2 .$$

F_1 is not computed. BETA = 1 does not allow for the initialization of the lighting time.

If the programmed burn is used, BETA = 2.0, the undetonated high explosive material will behave as an elastic perfectly plastic material if the bulk modulus, shear modulus, and yield stress are defined. Therefore, with this option the explosive material can compress without causing detonation. The location and time of detonation is controlled by *INITIAL_DETONATION.

As an option, the high explosive material can behave as an elastic perfectly-plastic solid prior to detonation. In this case we update the stress tensor, to an elastic trial stress, *

$$s_{ij}^{n+1} ,$$

$$* s_{ij}^{n+1} = s_{ij}^n + s_{ip} \Omega_{pj} + s_{jp} \Omega_{pi} + 2G \dot{\epsilon}'_{ij} dt$$

where G is the shear modulus, and $\dot{\epsilon}'_{ij}$ is the deviatoric strain rate. The von Mises yield condition is given by:

$$\phi = J_2 - \frac{\sigma_y^2}{3} ,$$

where the second stress invariant, J_2 , is defined in terms of the deviatoric stress components as

$$J_2 = \frac{1}{2} s_{ij} s_{ij}$$

and the yield stress is σ_y . If yielding has occurred, namely, $\phi > 0$, the deviatoric trial stress is scaled to obtain the final deviatoric stress at time $n + 1$:

$$s_{ij}^{n+1} = \frac{\sigma_y}{\sqrt{3J_2}} * s_{ij}^{n+1}$$

If $\phi \leq 0$, then

$$s_{ij}^{n+1} = * s_{ij}^{n+1}$$

Before detonation, pressure is given by the expression

$$p^{n+1} = K \left(\frac{1}{V^{n+1}} - 1 \right) ,$$

where K is the bulk modulus. Once the explosive material detonates:

$$s_{ij}^{n+1} = 0 ,$$

and the material behaves like a gas.

***MAT_NULL**

This is Material Type 9.

In the case of solids and thick shells, this material allows equations of state to be considered without computing deviatoric stresses. Optionally, a viscosity can be defined. Also, erosion in tension and compression is possible.

Beams and shells that use this material type are completely bypassed in the element processing; however, the mass of the null beam or shell elements is computed and added to the nodal points which define the connectivity. The mass of null beams is ignored if the value of the density is less than 10^{-11} . The Young's modulus and Poisson's ratio are used only for setting the contact stiffness, and it is recommended that reasonable values be input. The variables PC, MU, TEROD, and CEROD do not apply to beams and shells. Historically, null beams and/or null shells have been used as an aid in modeling of contact, but this practice is now seldom needed.

Card 1	1	2	3	4	5	6	7	8
Variable	MID	RO	PC	MU	TEROD	CEROD	YM	PR
Type	A	F	F	F	F	F	F	F
Defaults	none	none	0.0	0.0	0.0	0.0	0.0	0.0

VARIABLE**DESCRIPTION**

MID	Material identification. A unique number or label must be specified (see *PART).
RO	Mass density
PC	Pressure cutoff (≤ 0.0). See Remark 4 .
MU	Dynamic viscosity, μ (optional). See Remark 1 .
TEROD	Relative volume. V/V_0 , for erosion in tension. Typically, use values greater than unity. If zero, erosion in tension is inactive.
CEROD	Relative volume, V/V_0 , for erosion in compression. Typically, use values less than unity. If zero, erosion in compression is inactive.
YM	Young's modulus (used for null beams and shells only)

VARIABLE	DESCRIPTION
PR	Poisson's ratio (used for null beams and shells only)

Remarks:

These remarks apply to solids and thick shells only.

1. **Material Model.** When used with solids or thick shells, this material must be used with an equation-of-state. Pressure cutoff is negative in tension. A (deviatoric) viscous stress of the form,

$$\sigma'_{ij} = 2\mu\dot{\epsilon}'_{ij} ,$$

is computed for nonzero μ , where $\dot{\epsilon}'_{ij}$ is the deviatoric strain rate and μ is the dynamic viscosity. Analyzing the dimensions of the above equation gives units of the components in SI of

$$\left[\frac{N}{m^2} \right] \sim \left[\frac{N}{m^2} s \right] \left[\frac{1}{s} \right] .$$

Therefore, μ may have units of [Pa × s].

2. **Hourglass Control.** Null materials have no shear stiffness (except from viscosity) and hourglass control must be used with great care. In some applications, the default hourglass coefficient may lead to significant energy losses. In general, for fluids the hourglass coefficient QM should be small (in the range 10^{-6} to 10^{-4}), and the hourglass type IHQ should be set to 1 (default).
3. **Yield Strength.** The Null material has no yield strength and behaves in a fluid-like manner.
4. **Cut-off Pressure.** The cut-off pressure, PC, must be defined to allow for a material to “numerically” cavitate. In other words, when a material undergoes dilatation above certain magnitude, it should no longer be able to resist this dilatation. Since dilatation stress or pressure is negative, setting the PC limit to a very small negative number would allow for the material to cavitate once the pressure in the material goes below this negative value.

***MAT_ELASTIC_PLASTIC_HYDRO_{OPTION}**

This is Material Type 10. This material allows the modeling of an elastic-plastic hydrodynamic material and requires an equation-of-state (*EOS).

Available options include:

<BLANK>

SPALL

STOCHASTIC

The keyword card can appear in three ways:

*MAT_ELASTIC_PLASTIC_HYDRO or MAT_010

*MAT_ELASTIC_PLASTIC_HYDRO_SPALL or MAT_010_SPALL

*MAT_ELASTIC_PLASTIC_HYDRO_STOCHASTIC or MAT_010_STOCHASTIC

Card Summary:

Card 1. This card is required.

MID	RO	G	SIG0	EH	PC	FS	CHARL
-----	----	---	------	----	----	----	-------

Card 2. This card is included if and only if the SPALL keyword option is used.

A1	A2	SPALL					
----	----	-------	--	--	--	--	--

Card 3. This card is required.

EPS1	EPS2	EPS3	EPS4	EPS5	EPS6	EPS7	EPS8
------	------	------	------	------	------	------	------

Card 4. This card is required.

EPS9	EPS10	EPS11	EPS12	EPS13	EPS14	EPS15	EPS16
------	-------	-------	-------	-------	-------	-------	-------

Card 5. This card is required.

ES1	ES2	ES3	ES4	ES5	ES6	ES7	ES8
-----	-----	-----	-----	-----	-----	-----	-----

Card 6. This card is required.

ES9	ES10	ES11	ES12	ES13	ES14	ES15	ES16
-----	------	------	------	------	------	------	------

Data Card Definitions:

Card 1	1	2	3	4	5	6	7	8
Variable	MID	RO	G	SIG0	EH	PC	FS	CHARL
Type	A	F	F	F	F	F	F	F
Default	none	none	none	0.0	0.0	$-\infty$	0.0	0.0

VARIABLE**DESCRIPTION**

MID	Material identification. A unique number or label must be specified (see *PART).
RO	Mass density
G	Shear modulus
SIG0	Yield stress; see Remark 2 .
EH	Plastic hardening modulus; see Remark 2 .
PC	Pressure cutoff (≤ 0.0). If zero, a cutoff of $-\infty$ is assumed.
FS	Effective plastic strain at which erosion occurs.
CHARL	Characteristic element thickness for deletion. This applies to 2D solid elements that lie on a boundary of a part. If the boundary element thins down due to stretching or compression, and if it thins to a value less than CHARL, the element will be deleted. The primary application of this option is to predict the break-up of axisymmetric shaped charge jets.

Spall Card. Additional card for SPALL keyword option.

Card 2	1	2	3	4	5	6	7	8
Variable	A1	A2	SPALL					
Type	F	F	F					

VARIABLE	DESCRIPTION
A1	Linear pressure hardening coefficient
A2	Quadratic pressure hardening coefficient
SPALL	Spall type (see Remark 3): EQ.0.0: Default set to "1.0" EQ.1.0: Tensile pressure is limited by PC, that is, p is always \geq PC. EQ.2.0: If $\sigma_{\max} \geq -PC$ element spalls and tension, $p < 0$, is never allowed. EQ.3.0: $p < PC$ element spalls and tension, $p < 0$, is never allowed.

Card 3	1	2	3	4	5	6	7	8
Variable	EPS1	EPS2	EPS3	EPS4	EPS5	EPS6	EPS7	EPS8
Type	F	F	F	F	F	F	F	F

Card 4	1	2	3	4	5	6	7	8
Variable	EPS9	EPS10	EPS11	EPS12	EPS13	EPS14	EPS15	EPS16
Type	F	F	F	F	F	F	F	F

VARIABLE	DESCRIPTION
EPS i	Effective plastic strain (true). Define up to 16 values. Care must be taken that the full range of strains expected in the analysis is covered. Linear extrapolation is used if the strain values exceed the maximum input value. See Remark 2 .

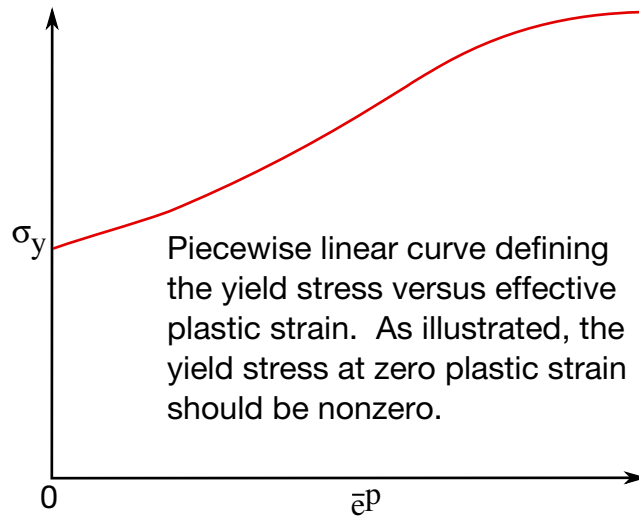

Figure M10-1. Effective stress as a function of effective plastic strain curve. See EPS and ES input.

Card 5	1	2	3	4	5	6	7	8
Variable	ES1	ES2	ES3	ES4	ES5	ES6	ES7	ES8
Type	F	F	F	F	F	F	F	F

Card 6	1	2	3	4	5	6	7	8
Variable	ES9	ES10	ES11	ES12	ES13	ES14	ES15	ES16
Type	F	F	F	F	F	F	F	F

VARIABLE

DESCRIPTION

ES_i Effective stress. Define up to 16 values. See [Remark 2](#).

Remarks:

1. **Model Overview.** This model is applicable to a wide range of materials, including those with pressure-dependent yield behavior. The use of 16 points in the yield stress as a function of effective plastic strain curve allows complex post-yield hardening behavior to be accurately represented. In addition, the incorporation of an equation of state permits accurate modeling of a variety of different

materials. The spall model options permit incorporation of material failure, fracture, and disintegration effects under tensile loads.

The STOCHASTIC option allows spatially varying yield and failure behavior. See *DEFINE_STOCHASTIC_VARIATION for additional information.

2. **Yield Stress and Plastic Hardening Modulus.** If ES and EPS values are undefined, the yield stress and plastic hardening modulus are taken from SIG0 and EH. In this case, the bilinear stress-strain curve shown in M10-1 is obtained with hardening parameter, $\beta = 1$. The yield strength is calculated as

$$\sigma_y = \sigma_0 + E_h \bar{\epsilon}^p + (a_1 + p a_2) \max[p, 0] .$$

The quantity E_h is the plastic hardening modulus defined in terms of Young's modulus, E , and the tangent modulus, E_t , as follows

$$E_h = \frac{E_t E}{E - E_t} .$$

The pressure, p , is taken as positive in compression.

If ES and EPS are specified, a curve like that shown in Figure M10-1 may be defined. Effective stress is defined in terms of the deviatoric stress tensor, s_{ij} , as:

$$\bar{\sigma} = \left(\frac{3}{2} s_{ij} s_{ij} \right)^{1/2}$$

and effective plastic strain by:

$$\bar{\epsilon}^p = \int_0^t \left(\frac{2}{3} D_{ij}^p D_{ij}^p \right)^{1/2} dt ,$$

where t denotes time and D_{ij}^p is the plastic component of the rate of deformation tensor. In this case the plastic hardening modulus on Card 1 is ignored and the yield stress is given as

$$\sigma_y = f(\bar{\epsilon}^p) ,$$

where the value for $f(\bar{\epsilon}^p)$ is found by interpolating the data curve.

3. **Spall Models.** A choice of three spall models is offered to represent material splitting, cracking, and failure under tensile loads.
 - a) The pressure limit model, SPALL = 1, limits the hydrostatic tension to the specified value, p_{cut} . If pressures more tensile than this limit are calculated, the pressure is reset to p_{cut} . This option is not strictly a spall model, since the deviatoric stresses are unaffected by the pressure reaching the tensile cutoff, and the pressure cutoff value, p_{cut} , remains unchanged throughout the analysis.

- b) The maximum principal stress spall model, SPALL = 2, detects spall if the maximum principal stress, σ_{\max} , exceeds the limiting value $-p_{\text{cut}}$. Note that the negative sign is required because p_{cut} is measured positive in compression, while σ_{\max} is positive in tension. Once spall is detected with this model, the deviatoric stresses are reset to zero, and no hydrostatic tension ($p < 0$) is permitted. If tensile pressures are calculated, they are reset to 0 in the spalled material. Thus, the spalled material behaves as a rubble or incohesive material.

- c) The hydrostatic tension spall model, SPALL = 3, detects spall if the pressure becomes more tensile than the specified limit, p_{cut} . Once spall is detected the deviatoric stresses are reset to zero, and nonzero values of pressure are required to be compressive (positive). If hydrostatic tension ($p < 0$) is subsequently calculated, the pressure is reset to 0 for that element.

***MAT_STEINBERG**

This is Material Type 11. This material is available for modeling materials deforming at very high strain rates ($> 10^5$ per second) and can be used with solid elements. The yield strength is a function of temperature and pressure. An equation of state determines the pressure.

This model applies to a wide range of materials, including those with pressure-dependent yield behavior. In addition, the incorporation of an equation-of-state permits accurate modeling of a variety of different materials. The spall model options permit the incorporation of material failure, fracture, and disintegration effects under tensile loads.

Card 1	1	2	3	4	5	6	7	8
Variable	MID	RO	G0	SIG0	BETA	N	GAMA	SIGM
Type	A	F	F	F	F	F	F	F

Card 2	1	2	3	4	5	6	7	8
Variable	B	BP	H	F	A	TMO	GAMO	SA
Type	F	F	F	F	F	F	F	F

Card 3	1	2	3	4	5	6	7	8
Variable	PC	SPALL	RP	FLAG	MMN	MMX	ECO	EC1
Type	F	F	F	F	F	F	F	F

Card 4	1	2	3	4	5	6	7	8
Variable	EC2	EC3	EC4	EC5	EC6	EC7	EC8	EC9
Type	F	F	F	F	F	F	F	F

VARIABLE	DESCRIPTION
MID	Material identification. A unique number or label must be specified (see *PART).
RO	Mass density
G0	Basic shear modulus. See Remark 2 .
SIGO	σ_o ; see Remark 3 below.
BETA	β ; see Remark 3 below.
N	n ; see Remark 3 below.
GAMA	γ_i , initial plastic strain; see Remark 3 below.
SIGM	σ_m ; see Remark 3 .
B	b ; see Remark 2 .
BP	b' ; see Remark 3 .
H	h ; see Remarks 2 and 3 .
F	f ; see Remark 3 .
A	Atomic weight (if = 0.0, RP must be defined). See Remark 2 .
TMO	T_{mo} ; see Remark 2 .
GAMO	γ_o ; see Remark 2 .
SA	a ; see Remark 2 .
PC	Pressure cutoff (default = -10^{30}). See Remark 5 .
SPALL	Spall type (see Remark 5): EQ.0.0: Default, set to "2.0" EQ.1.0: $p \geq PC$ EQ.2.0: If $\sigma_{max} \geq -PC$, element spalls, and tension, $p < 0$, is never allowed. EQ.3.0: If $p < PC$ element spalls, and tension, $p < 0$, is never allowed.
RP	R' . If $R' \neq 0.0$, A is not defined. See Remark 2 .

VARIABLE	DESCRIPTION
FLAG	Flag for cold compression energy fit (see Remarks 2 and 4): EQ.0.0: η coefficients (default) EQ.1.0: μ coefficients
MMN	Optional μ or η minimum value (μ_{\min} or η_{\min}), depending on FLAG.
MMX	Optional μ or η maximum value (μ_{\max} or η_{\max}), depending on FLAG.
EC0, ..., EC9	Cold compression energy coefficients (optional). See Remark 2 .

Remarks:

- References.** Users who have an interest in this model are encouraged to study the paper by Steinberg and Guinan which provides the theoretical basis. Another useful reference is the KOVEC user's manual.
- Shear Modulus.** In terms of the foregoing input parameters, we define the shear modulus, G , before the material melts as:

$$G = G_0 \left[1 + bpV^{1/3} - h \left(\frac{E_i - E_c}{3R'} - 300 \right) \right] e^{\frac{-fE_i}{E_m - E_i}},$$

where p is the pressure, V is the relative volume, E_c (see [Remark 4](#)) is the cold compression energy, and E_m is the melting energy. E_c is given by:

$$E_c(x) = \int_0^x p(X) dX - \frac{900R' \exp(ax)}{(1-x)^{(\gamma_0 - a)}}$$

with

$$x = 1 - V.$$

E_m is defined as:

$$E_m(x) = E_c(x) + 3R'T_m(x).$$

E_m is in terms of the melting temperature $T_m(x)$:

$$T_m(x) = \frac{T_{mo} \exp(2ax)}{V^{2(\gamma_0 - a - 1/3)}}$$

and the melting temperature at $\rho = \rho_0$, T_{mo} .

In the above equations R' is defined by

$$R' = \frac{R\rho}{A},$$

where R is the gas constant and A is the atomic weight. If R' is not defined, LS-DYNA computes it with R in the cm-gram-microsecond system of units.

3. **Yield Strength.** The yield strength, σ_y , is given by:

$$\sigma_y = \sigma'_o \left[1 + b' p V^{1/3} - h \left(\frac{E_i - E_c}{3R'} - 300 \right) \right] e^{\frac{-fE_i}{E_m - E_i}}$$

if E_m exceeds E_i (see Remark 2). Here, σ'_o is:

$$\sigma'_o = \sigma_o [1 + \beta(\gamma_i + \bar{\epsilon}^p)]^n$$

where σ_o is the initial yield stress and γ_i is the initial plastic strain. If the work-hardened yield stress σ'_o exceeds σ_m , σ'_o is set equal to σ_m . After the materials melt, σ_y and G are set to one half their initial value.

4. **Cold Compression Energy.** If the coefficients EC0, ..., EC9 are not defined above, LS-DYNA will fit the cold compression energy to a ten term polynomial expansion either as a function of μ or η depending on field FLAG as:

$$E_c(\eta^i) = \sum_{i=0}^9 EC_i \eta^i$$

$$E_c(\mu^i) = \sum_{i=0}^9 EC_i \mu^i$$

where EC_i is the i^{th} coefficient and:

$$\eta = \frac{\rho}{\rho_o}$$

$$\mu = \frac{\rho}{\rho_o} - 1$$

A linear least squares method is used to perform the fit.

5. **Spall Models.** A choice of three spall models is offered to represent material splitting, cracking, and failure under tensile loads.

a) *Pressure Limit Model.* The pressure limit model, SPALL = 1, limits the hydrostatic tension to the specified value, p_{cut} . If a pressure more tensile than this limit is calculated, the pressure is reset to p_{cut} . This option is not strictly a spall model, since the deviatoric stresses are unaffected by the pressure reaching the tensile cutoff, and the pressure cutoff value, p_{cut} , remains unchanged throughout the analysis.

b) *Maximum Principal Stress Spall Model.* The maximum principal stress spall model, SPALL = 2, detects spall if the maximum principal stress, σ_{max} , exceeds the limiting value $-p_{\text{cut}}$. Note that the negative sign is required

because p_{cut} is measured positive in compression, while σ_{max} is positive in tension. Once spall is detected with this model, the deviatoric stresses are reset to zero, and no hydrostatic tension ($p < 0$) is permitted. If tensile pressures are calculated, they are reset to 0 in the spalled material. Thus, the spalled material behaves as a rubble or incohesive material.

- c) *Hydrostatic Tension Spall Model.* The hydrostatic tension spall model, SPALL = 3, detects spall if the pressure becomes more tensile than the specified limit, p_{cut} . Once spall is detected the deviatoric stresses are reset to zero, and nonzero values of pressure are required to be compressive (positive). If hydrostatic tension ($p < 0$) is subsequently calculated, the pressure is reset to 0 for that element.

***MAT_STEINBERG_LUND**

This is Material Type 11. This material is a modification of the Steinberg model above to include the rate model of Steinberg and Lund [1989]. An equation of state determines the pressure.

The keyword cards can appear in two ways:

*MAT_STEINBERG_LUND or MAT_011_LUND

Card Summary:

Card 1. This card is required.

MID	RO	GO	SIGO	BETA	N	GAMA	SIGM
-----	----	----	------	------	---	------	------

Card 2. This card is required.

B	BP	H	F	A	TMO	GAMO	SA
---	----	---	---	---	-----	------	----

Card 3. This card is required.

PC	SPALL	RP	FLAG	MMN	MMX	ECO	EC1
----	-------	----	------	-----	-----	-----	-----

Card 4. This card is required.

EC2	EC3	EC4	EC5	EC6	EC7	EC8	EC9
-----	-----	-----	-----	-----	-----	-----	-----

Card 5. This card is required.

UK	C1	C2	YP	YA	YM		
----	----	----	----	----	----	--	--

Data Card Definitions:

Card 1	1	2	3	4	5	6	7	8
Variable	MID	RO	GO	SIGO	BETA	N	GAMA	SIGM
Type	A	F	F	F	F	F	F	F

VARIABLE	DESCRIPTION
MID	Material identification. A unique number or label must be specified (see *PART).
RO	Mass density
G0	Basic shear modulus
SIGO	σ_o ; see Remark 3 of *MAT_011.
BETA	β ; see Remark 3 of *MAT_011.
N	n ; see Remark 3 of *MAT_011.
GAMA	γ_i , initial plastic strain; see Remark 3 of *MAT_011.
SIGM	σ_m ; see Remark 3 of *MAT_011.

Card 2	1	2	3	4	5	6	7	8
Variable	B	BP	H	F	A	TMO	GAMO	SA
Type	F	F	F	F	F	F	F	F

VARIABLE	DESCRIPTION
B	b ; see Remark 2 of *MAT_011
BP	b' ; see Remark 3 of *MAT_011.
H	h ; see Remarks 2 and 3 of *MAT_011.
F	f ; see Remark 3 of *MAT_011.
A	Atomic weight (if = 0.0, RP must be defined). See Remark 2 of *MAT_011.
TMO	T_{mo} ; see Remark 2 of *MAT_011.
GAMO	γ_o ; see Remark 2 of *MAT_011.
SA	a ; see Remark 2 of *MAT_011.

Card 3	1	2	3	4	5	6	7	8
Variable	PC	SPALL	RP	FLAG	MMN	MMX	EC0	EC1
Type	F	F	F	F	F	F	F	F

Card 4	1	2	3	4	5	6	7	8
Variable	EC2	EC3	EC4	EC5	EC6	EC7	EC8	EC9
Type	F	F	F	F	F	F	F	F

VARIABLE**DESCRIPTION**

PC	Pressure cutoff (p_{cut}) or $-\sigma_f$ (default = -10^{30})
SPALL	Spall type (see Remark 5 of *MAT_011): EQ.0.0: Default, set to "2.0" EQ.1.0: $p \geq \text{PC}$ EQ.2.0: If $\sigma_{\text{max}} \geq -\text{PC}$, element spalls, and tension, $p < 0$, is never allowed. EQ.3.0: If $p < \text{PC}$ element spalls, and tension, $p < 0$, is never allowed.
RP	R' . If $R' \neq 0.0$, A is not defined. See Remark 2 of *MAT_011.
FLAG	Flag for cold compression energy fit (see Remarks 2 and 4 of *MAT_011): EQ.0.0: η coefficients (default) EQ.1.0: μ coefficients
MMN	Optional μ or η minimum value (μ_{min} or η_{min}), depending on FLAG.
MMX	Optional μ or η maximum value (μ_{max} or η_{max}), depending on FLAG.
EC0, ..., EC9	Cold compression energy coefficients (optional). See Remark 2 of *MAT_011.

Card 5	1	2	3	4	5	6	7	8
Variable	UK	C1	C2	YP	YA	YM		
Type	F	F	F	F	F	F		

VARIABLE**DESCRIPTION**

UK	Activation energy for rate dependent model
C1	Exponent pre-factor in rate dependent model
C2	Coefficient of drag term in rate dependent model
YP	Peierls stress for rate dependent model
YA	A thermal yield stress for rate dependent model
YMAX	Work hardening maximum for rate model

Remarks:

This model is similar in theory to the *MAT_STEINBERG above but with the addition of rate effects. When rate effects are included, the yield stress is given by:

$$\sigma_y = \{Y_T(\dot{\epsilon}_p, T) + Y_{Af}(\epsilon_p)\} \frac{G(p, T)}{G_0} .$$

There are two imposed limits on the yield stress. The first condition is on the nonthermal yield stress:

$$Y_{Af}(\epsilon_p) = Y_A [1 + \beta(\gamma_i + \epsilon^p)]^n \leq Y_{\max}$$

and comes from the limit of the first term in σ_y being small. In this case $Y_{Af}(\epsilon_p)$ reduces to σ'_0 from the *MAT_011 material model (see [Remark 3](#) of *MAT_011). The second limit is on the thermal part:

$$Y_T \leq Y_P .$$

*MAT_ISOTROPIC_ELASTIC_PLASTIC

This is Material Type 12. This is a very low cost isotropic plasticity model for three-dimensional solids. In the plane stress implementation for shell elements, a one-step radial return approach is used to scale the Cauchy stress tensor if the state of stress exceeds the yield surface. This approach to plasticity leads to inaccurate shell thickness updates and stresses after yielding. This is the only model in LS-DYNA for plane stress that does not default to an iterative approach.

Card	1	2	3	4	5	6	7	8
Variable	MID	RO	G	SIGY	ETAN	BULK		
Type	A	F	F	F	F	F		

VARIABLE

DESCRIPTION

MID	Material identification. A unique number or label must be specified (see *PART).
RO	Mass density
G	Shear modulus
SIGY	Yield stress
ETAN	Plastic hardening modulus
BULK	Bulk modulus, <i>K</i>

Remarks:

The pressure is integrated in time from

$$\dot{p} = -K\dot{\epsilon}_{ii} ,$$

where $\dot{\epsilon}_{ii}$ is the volumetric strain rate.

***MAT_ISOTROPIC_ELASTIC_FAILURE**

This is Material Type 13. This is a non-iterative plasticity with simple plastic strain failure model.

Card 1	1	2	3	4	5	6	7	8
Variable	MID	RO	G	SIGY	ETAN	BULK		
Type	A	F	F	F	F	F		
Default	none	none	none	none	0.0	none		

Card 2	1	2	3	4	5	6	7	8
Variable	EPF	PRF	REM	TREM				
Type	F	F	F	F				
Default	none	0.0	0.0	0.0				

VARIABLE**DESCRIPTION**

MID	Material identification. A unique number or label must be specified (see *PART).
RO	Mass density
G	Shear modulus
SIGY	Yield stress
ETAN	Plastic hardening modulus
BULK	Bulk modulus
EPF	Plastic failure strain
PRF	Failure pressure (≤ 0.0)

VARIABLE	DESCRIPTION
REM	Element erosion option: EQ.0.0: failed element eroded after failure. NE.0.0: element is kept, no removal except by Δt below.
TREM	Δt for element removal: EQ.0.0: Δt is not considered (default). GT.0.0: element eroded if element time step size falls below Δt .

Remarks:

When the effective plastic strain reaches the failure strain or when the pressure reaches the failure pressure, the element loses its ability to carry tension and the deviatoric stresses are set to zero, causing the material to behave like a fluid. If Δt for element removal is defined, the element removal option is ignored.

The element erosion option based on Δt must be used cautiously with the contact options. Nodes to surface contact is recommended with all nodes of the eroded brick elements included in the node list. As the elements are eroded the mass remains and continues to interact with the master surface.

***MAT_SOIL_AND_FOAM_FAILURE**

This is Material Type 14. The input for this model is the same as for *MATERIAL_SOIL_-AND_FOAM (Type 5); however, when the pressure reaches the tensile failure pressure, the element loses its ability to carry tension. It should be used only in situations when soils and foams are confined within a structure or are otherwise confined by nodal boundary conditions.

*MAT_JOHNSON_COOK_{OPTION}

This is Material Type 15. The Johnson/Cook strain and temperature sensitive plasticity is sometimes used for problems where the strain rates vary over a large range and adiabatic temperature increases due to plastic heating cause material softening. When used with solid elements, this model requires an equation-of-state. If thermal effects and damage are unimportant, we recommend the much less expensive *MAT_SIMPLIFIED_JOHNSON_COOK model. The simplified model can be used with beam elements.

Material type 15 is applicable to the high rate deformation of many materials including most metals. Unlike the Steinberg-Guinan model, the Johnson-Cook model remains valid down to lower strain rates and even into the quasistatic regime. Typical applications include explosive metal forming, ballistic penetration, and impact.

Available options include:

<BLANK>

STOCHASTIC

The STOCHASTIC option enables spatially varying yield and failure behavior. See *DEFINE_STOCHASTIC_VARIATION for additional information.

Card Summary:

Card 1. This card is required.

MID	RO	G	E	PR	DTF	VP	RATEOP
-----	----	---	---	----	-----	----	--------

Card 2. This card is required.

A	B	N	C	M	TM	TR	EPS0
---	---	---	---	---	----	----	------

Card 3. This card is required.

CP	PC	SPALL	IT	D1	D2	D3	D4
----	----	-------	----	----	----	----	----

Card 4a. This card is included for RATEOP = 0.0 or 2.0 or for VP = 0.0.

D5		EROD	EFMIN	NUMINT			
----	--	------	-------	--------	--	--	--

Card 4b. This card is included for RATEOP = 1.0, 3.0, or 4.0.

D5	C2/P/XNP	EROD	EFMIN	NUMINT			
----	----------	------	-------	--------	--	--	--

Card 4c. This card is included for RATEOP = 5.0.

D5	D	EROD	EFMIN	NUMINT	K	EPS1	
----	---	------	-------	--------	---	------	--

Data Card Definitions:

Card 1	1	2	3	4	5	6	7	8
Variable	MID	RO	G	E	PR	DTF	VP	RATEOP
Type	A	F	F	F	F	F	F	F
Default	none	none	none	none	none	0.0	0.0	0.0

VARIABLE

DESCRIPTION

MID	Material identification. A unique number or label must be specified (see *PART).
RO	Mass density
G	Shear modulus. G and an equation-of-state are required for element types that use a 3D stress update, such as solids, 2D shell forms 13-15, and tshell forms 3, 5, and 7. For other element types, G is ignored, and E and PR must be provided.
E	Young’s Modulus (see note above pertaining to G)
PR	Poisson’s ratio (see note above pertaining to G)
DTF	Minimum time step size for automatic element deletion (shell elements). The element will be deleted when the solution time step size drops below DTF × TSSFAC where TSSFAC is the time step scale factor defined by *CONTROL_TIMESTEP. See Remark 4 .
VP	Formulation for rate effects: EQ.0.0: Scale yield stress (default) EQ.1.0: Viscoplastic formulation
RATEOP	Form of strain rate term. RATEOP is ignored if VP = 0. See Remark 5 .

VARIABLE	DESCRIPTION							
	EQ.0.0: Log-linear Johnson-Cook (default)							
	EQ.1.0: Log-quadratic Huh-Kang (2 parameters)							
	EQ.2.0: Exponential Allen-Rule-Jones							
	EQ.3.0: Exponential Cowper-Symonds (2 parameters)							
	EQ.4.0: Nonlinear rate coefficient (2 parameters)							
	EQ.5.0: Log-exponential Couque (4 parameters)							
Card 2	1	2	3	4	5	6	7	8
Variable	A	B	N	C	M	TM	TR	EPS0
Type	F	F	F	F	F	F	F	F
Default	none	0.0	0.0	0.0	none	none	none	none

VARIABLE	DESCRIPTION
A	Constant A in the flow stress. See equations in Remark 1 .
B	Constant B in the flow stress. See equations in Remark 1 .
N	Constant n in the flow stress. See equations in Remark 1 .
C	Constant C in the flow stress. See equations in Remarks 1 and 5 .
M	Constant m in the flow stress. See equations in Remark 1 .
TM	Melt temperature
TR	Room temperature
EPS0	Quasi-static threshold strain rate (see Remark 1). Ideally, this value represents the highest strain rate for which no rate adjustment to the flow stress is needed and is input in units of $[\text{time}]^{-1}$. For example, if strain rate effects on the flow stress first become apparent at strain rates greater than 10^{-2} s^{-1} , and the system of units for the model input is {kg, mm, ms}, then EPS0 should be set to 10^{-5} .

Card 3	1	2	3	4	5	6	7	8
Variable	CP	PC	SPALL	IT	D1	D2	D3	D4
Type	F	F	F	F	F	F	F	F
Default	none	0.0	2.0	0.0	0.0	0.0	0.0	0.0

VARIABLE

DESCRIPTION

CP	Specific heat (superseded by heat capacity in *MAT_THERMAL_OPTION if a coupled thermal/structural analysis)
PC	Tensile failure stress or tensile pressure cutoff (PC < 0.0)
SPALL	<p>Spall type (see Remark 3):</p> <p>EQ.0.0: Set to "2.0" (default).</p> <p>EQ.1.0: Tensile pressure is limited by PC, that is, p is always \geq PC.</p> <p><i>Shell Element Specific Behavior:</i></p> <p>EQ.2.0: Shell elements are deleted when $\sigma_{max} \geq -PC$.</p> <p>EQ.3.0: Shell elements are deleted when $p < PC$.</p> <p><i>Solid Element Specific Behavior</i></p> <p>EQ.2.0: For solid elements $\sigma_{max} \geq -PC$ resets tensile stresses to zero. Compressive stress are still allowed.</p> <p>EQ.3.0: For solid elements $p < PC$ resets the pressure to zero thereby disallowing tensile pressure.</p>
IT	<p>Plastic strain iteration option. This input applies to solid elements only since it is always necessary to iterate for the shell element plane stress condition.</p> <p>EQ.0.0: No iterations (default)</p> <p>EQ.1.0: Accurate iterative solution for plastic strain. Much more expensive than default.</p>
D1 – D4	Failure parameters; see Remark 2 . If D3 < 0.0, it will be converted to its absolute value.

This card is included for RATEOP = 0.0 or 2.0 or for VP = 0.0.

Card 4a	1	2	3	4	5	6	7	8
Variable	D5		EROD	EFMIN	NUMINT			
Type	F		F	F	I			
Default	0.0		0.0	10^{-6}	0			

VARIABLE**DESCRIPTION**

D5	Failure parameter; see Remark 2 .
EROD	Erosion flag: EQ.0.0: Element erosion allowed (default). NE.0.0: Element does not erode; deviatoric stresses set to zero when element fails.
EFMIN	Lower bound for calculated strain at fracture (see Remark 2)
NUMINT	Number of through thickness integration points which must fail before the shell element is deleted. If zero, all integration points must fail (the default). Since nodal fiber rotations limit strains at active integration points, we do not recommend the default because elements undergoing large strain are often not deleted using this criterion. Better results may be obtained when NUMINT is set to 1 or a number less than one half of the number of through thickness points. For example, if four through thickness points are used, NUMINT should not exceed 2, even for fully integrated shells which have 16 integration points.

This card is included for RATEOP = 1.0, 3.0, or 4.0.

Card 4b	1	2	3	4	5	6	7	8
Variable	D5	C2/P/XNP	EROD	EFMIN	NUMINT			
Type	F	F	F	F	I			
Default	0.0	0.0	0.0	10^{-6}	0			

VARIABLE	DESCRIPTION
----------	-------------

D5	Failure parameter; see Remark 2 .												
C2/P/XNP	Strain rate parameter.												
	<table border="1"> <thead> <tr> <th>Field</th> <th>Var</th> <th>Model</th> </tr> </thead> <tbody> <tr> <td>C2</td> <td>C_2</td> <td>Huh-Kang</td> </tr> <tr> <td>P</td> <td>P</td> <td>Cowper-Symonds</td> </tr> <tr> <td>XNP</td> <td>n'</td> <td>Nonlinear Rate Coefficient</td> </tr> </tbody> </table>	Field	Var	Model	C2	C_2	Huh-Kang	P	P	Cowper-Symonds	XNP	n'	Nonlinear Rate Coefficient
Field	Var	Model											
C2	C_2	Huh-Kang											
P	P	Cowper-Symonds											
XNP	n'	Nonlinear Rate Coefficient											

See [Remark 5](#) for a description of these models.

EROD	Erosion flag: EQ.0.0: Element erosion allowed (default). NE.0.0: Element does not erode; deviatoric stresses set to zero when element fails.
------	--

EFMIN	Lower bound for calculated strain at fracture (see Remark 2)
-------	---

NUMINT

Number of through thickness integration points which must fail before the shell element is deleted. If zero, all integration points must fail (the default). Since nodal fiber rotations limit strains at active integration points, we do not recommend the default because elements undergoing large strain are often not deleted using this criterion. Better results may be obtained when NUMINT is set to 1 or a number less than one half of the number of through thickness points. For example, if four through thickness points are used, NUMINT should not exceed 2, even for fully integrated shells which have 16 integration points.

This card is included for RATEOP = 5.0.

Card 4c	1	2	3	4	5	6	7	8
Variable	D5	D	EROD	EFMIN	NUMINT	K	EPS1	
Type	F	F	F	F	I	F	F	
Default	0.0	0.0	0.0	10 ⁻⁶	0	0.0	none	

VARIABLE	DESCRIPTION
D5	Failure parameter; see Remark 2 .
D	Strain rate parameter D for Couque term. See Remark 5 .
EROD	Erosion flag: EQ.0.0: Element erosion allowed (default). NE.0.0: Element does not erode; deviatoric stresses set to zero when element fails.
EFMIN	Lower bound for calculated strain at fracture (see Remark 2)
NUMINT	Number of through thickness integration points which must fail before the shell element is deleted. If zero, all integration points must fail (the default). Since nodal fiber rotations limit strains at active integration points, we do not recommend the default because elements undergoing large strain are often not deleted using this criterion. Better results may be obtained when NUMINT is set to 1 or a number less than one half of the number of through thickness points. For example, if four through thickness points are used, NUMINT should not exceed 2, even for fully integrated shells which have 16 integration points.
K	Strain rate parameter for Couque term. See Remark 5 .
EPS1	Reference strain rate for Couque term, characterizing the transition between the thermally activated regime and the viscous regime. Input in units of $[\text{time}]^{-1}$. See Remark 5 .

Remarks:

- Flow Stress.** Johnson and Cook express the flow stress as

$$\sigma_y = (A + B\bar{\epsilon}^{p^n})(1 + C \ln \dot{\epsilon}^*)(1 - T^{*m}) ,$$

where

$A, B, C, n,$ and m = input constants

$\bar{\epsilon}^p$ = effective plastic strain

$\dot{\epsilon}^*$

$$= \begin{cases} \frac{\dot{\epsilon}}{\text{EPS0}} & \text{for VP} = 0 \quad (\text{normalized effective total strain rate}) \\ \frac{\dot{\epsilon}^p}{\text{EPS0}} & \text{for VP} = 1 \quad (\text{normalized effective plastic strain rate}) \end{cases}$$

$$T^* = \text{homologous temperature} = \frac{T - T_{\text{room}}}{T_{\text{melt}} - T_{\text{room}}}$$

The quantity $T - T_{\text{room}}$ is stored as extra history variable 5. In the case of a mechanical-only analysis, this is the adiabatic temperature increase calculated as

$$T - T_{\text{room}} = \frac{\text{internal energy}}{(C_p \times \rho \times V_0)},$$

where

$$\begin{aligned} C_p \text{ and } \rho &= \text{input constants} \\ V_0 &= \text{initial volume} \end{aligned}$$

In a coupled thermal/mechanical analysis, $T - T_{\text{room}}$ includes heating/cooling from all sources, not just adiabatic heating from the internal energy.

Constants for a variety of materials are provided in Johnson and Cook [1983]. A fully viscoplastic formulation is optional (VP) which incorporates the rate equations within the yield surface. An additional cost is incurred, but the improvement in the results can be dramatic.

Due to nonlinearity in the dependence of flow stress on plastic strain, an accurate value of the flow stress requires iteration for the increment in plastic strain. However, by using a Taylor series expansion with linearization about the current time, we can solve for σ_y with sufficient accuracy to avoid iteration.

2. **Strain at Fracture.** The strain at fracture is given by

$$\epsilon^f = \max([D_1 + D_2 \exp D_3 \sigma^*][1 + D_4 \ln \dot{\epsilon}^*][1 + D_5 T^*], \text{EFMIN}) ,$$

where σ^* is the ratio of pressure divided by effective stress

$$\sigma^* = \frac{p}{\sigma_{\text{eff}}} .$$

Fracture occurs when the damage parameter,

$$D = \sum \frac{\Delta \bar{\epsilon}^p}{\epsilon^f} ,$$

reaches the value of 1. D is stored as extra history variable 4 in shell elements and extra history variable 6 in solid elements.

3. **Spall Models.** A choice of three spall models is offered to represent material splitting, cracking, and failure under tensile loads:

- a) *Pressure Limit Model.* The pressure limit model limits the minimum hydrostatic pressure to the specified value, $p \geq p_{\text{min}}$. If the calculated pressure is more tensile than this limit, the pressure is reset to p_{min} . This option is not strictly a spall model since the deviatoric stresses are unaffected by the

pressure reaching the tensile cutoff and the pressure cutoff value p_{\min} remains unchanged throughout the analysis.

- b) *Maximum Principal Stress Model.* The maximum principal stress spall model detects spall if the maximum principal stress, σ_{\max} , exceeds the limiting value σ_p . Once spall in solids is detected with this model, the deviatoric stresses are reset to zero, and no hydrostatic tension is permitted. If tensile pressures are calculated, they are reset to 0 in the spalled material. Thus, the spalled material behaves as rubble.
 - c) *Hydrostatic Tension Model.* The hydrostatic tension spall model detects spall if the pressure becomes more tensile than the specified limit, p_{\min} . Once spall in solids is detected with this model, the deviatoric stresses are set to zero, and the pressure is required to be compressive. If hydrostatic tension is calculated, then the pressure is reset to 0 for that element.
4. **Shell Element Deletion Based on Time Step.** This material model also supports a shell element deletion criterion based on the maximum stable time step size for the element, Δt_{\max} (see DTF on Card 1). Generally, Δt_{\max} goes down as the element becomes more distorted. To assure stability of time integration, the global LS-DYNA time step is the minimum of the Δt_{\max} values calculated for all elements in the model. Using this option allows the selective deletion of elements whose time step, Δt_{\max} , has fallen below the specified minimum time step, Δt_{crit} . Elements which are severely distorted often indicate that material has failed and supports little load, but these same elements may have very small time steps and, therefore, control the cost of the analysis. This option allows these highly distorted elements to be deleted from the calculation, and, therefore, the analysis can proceed at a larger time step, and, thus, at a reduced cost. Deleted elements do not carry any load and are deleted from all applicable slide surface definitions. Clearly, this option must be judiciously used to obtain accurate results at a minimum cost.
5. **Optional Strain Rate Forms.** The standard Johnson-Cook strain rate term is linear in the logarithm of the strain rate (see [Remark 1](#)):

$$1 + C \ln \dot{\epsilon}^*$$

You can replace this term by setting RATEOP > 0. These additional rate forms are currently available for solid and shell elements but only when the viscoplastic rate option is active (VP = 1). If VP is set to zero, RATEOP is ignored.

The first additional available rate form enables some additional data fitting by using the quadratic form proposed by Huh & Kang [2002]:

$$1 + C \ln \dot{\epsilon}^* + C_2 (\ln \dot{\epsilon}^*)^2$$

Four additional exponential forms are available, one due to Allen, Rule & Jones [1997]:

$$(\dot{\epsilon}^*)^C ,$$

the Cowper-Symonds-like [1958] form:

$$1 + \left(\frac{\dot{\epsilon}_{\text{eff}}^p}{C} \right)^{\frac{1}{P}} ,$$

the nonlinear rate coefficient:

$$1 + C(\epsilon_{\text{eff}}^p)^{n'} \ln \dot{\epsilon}^* .$$

and the Couque [2014] form,

$$1 + C \ln \dot{\epsilon}^* + D \left(\frac{\dot{\epsilon}_{\text{eff}}^p}{\text{EPS1}} \right)^k .$$

See Huh and Kang [2002], Allen, Rule, and Jones [1997], Cowper and Symonds [1958], and Couque [2014].

- 6. **History Variables.** The following extra history variables may be output to the d3plot file (see *DATABASE_EXTENT_BINARY).

History Variable #	Description for Shell Elements	Description for Solid Elements
1	Failure value	
3	Current pressure cutoff	
4	Damage parameter, D	
5	Temperature change, $T - T_{\text{room}}$	Temperature change, $T - T_{\text{room}}$
6	Failure strain	Damage parameter, D

*MAT_PSEUDO_TENSOR

This is Material Type 16. This model has been used to analyze buried steel reinforced concrete structures subjected to impulsive loadings.

This model can be used in two major modes - a simple tabular pressure-dependent yield surface and a potentially complex model featuring two yield as a function of pressure functions with the means of migrating from one curve to the other. These modes are discussed in detail in the Remarks section. For both modes, load curve LCP is taken to be a strain rate multiplier for the yield strength. Note that this model must be used with equation-of-state type 8, 9 or 11.

Card Summary:

Card 1. This card is required.

MID	RO	G	PR				
-----	----	---	----	--	--	--	--

Card 2. This card is required.

SIGF	A0	A1	A2	A0F	A1F	B1	PER
------	----	----	----	-----	-----	----	-----

Card 3. This card is required.

ER	PRR	SIGY	ETAN	LCP	LCR		
----	-----	------	------	-----	-----	--	--

Card 4. This card is required.

X1	X2	X3	X4	X5	X6	X7	X8
----	----	----	----	----	----	----	----

Card 5. This card is required.

X9	X10	X11	X12	X13	X14	X15	X16
----	-----	-----	-----	-----	-----	-----	-----

Card 6. This card is required.

YS1	YS2	YS3	YS4	YS5	YS6	YS7	YS8
-----	-----	-----	-----	-----	-----	-----	-----

Card 7. This card is required.

YS9	YS10	YS11	YS12	YS13	YS14	YS15	YS16
-----	------	------	------	------	------	------	------

Data Card Definitions:

Card 1	1	2	3	4	5	6	7	8
Variable	MID	RO	G	PR				
Type	A	F	F	F				
Default	none	none	none	none				

VARIABLE**DESCRIPTION**

MID	Material identification. A unique number or label must be specified (see *PART).
RO	Mass density
G	Shear modulus
PR	Poisson's ratio

Card 2	1	2	3	4	5	6	7	8
Variable	SIGF	A0	A1	A2	A0F	A1F	B1	PER
Type	F	F	F	F	F	F	F	F
Default	0.0	0.0	0.0	0.0	0.0	0.0	0.0	0.0

VARIABLE**DESCRIPTION**

SIGF	Tensile cutoff (maximum principal stress for failure)
A0	Cohesion
A1	Pressure hardening coefficient
A2	Pressure hardening coefficient
A0F	Cohesion for failed material
A1F	Pressure hardening coefficient for failed material

VARIABLE	DESCRIPTION
B1	Damage scaling factor (or exponent in Mode II.C)
PER	Percent reinforcement

Card 3	1	2	3	4	5	6	7	8
Variable	ER	PRR	SIGY	ETAN	LCP	LCR		
Type	F	F	F	F	F	F		
Default	0.0	0.0	none	0.0	none	none		

VARIABLE	DESCRIPTION
ER	Elastic modulus for reinforcement
PRR	Poisson's ratio for reinforcement
SIGY	Initial yield stress
ETAN	Tangent modulus/plastic hardening modulus
LCP	Load curve ID giving rate sensitivity for principal material; see *DEFINE_CURVE.
LCR	Load curve ID giving rate sensitivity for reinforcement; see *DEFINE_CURVE.

Card 4	1	2	3	4	5	6	7	8
Variable	X1	X2	X3	X4	X5	X6	X7	X8
Type	F	F	F	F	F	F	F	F
Default	none	none	none	none	none	none	none	none

Card 5	1	2	3	4	5	6	7	8
Variable	X9	X10	X11	X12	X13	X14	X15	X16
Type	F	F	F	F	F	F	F	F
Default	none	none	none	none	none	none	none	none

VARIABLE

DESCRIPTION

X_n Effective plastic strain, damage, or pressure. See Remarks below.

Card 6	1	2	3	4	5	6	7	8
Variable	YS1	YS2	YS3	YS4	YS5	YS6	YS7	YS8
Type	F	F	F	F	F	F	F	F
Default	none	none	none	none	none	none	none	none

Card 7	1	2	3	4	5	6	7	8
Variable	YS9	YS10	YS11	YS12	YS13	YS14	YS15	YS16
Type	F	F	F	F	F	F	F	F
Default	none	none	none	none	none	none	none	none

VARIABLE

DESCRIPTION

YS_n Yield stress (Mode I) or scale factor (Mode II.B or II.C)

Remarks:

- Response Mode I (Tabulated Yield Stress as a Function of Pressure).** This model is well suited for implementing standard geologic models like the Mohr-Coulomb yield surface with a Tresca limit, as shown in [Figure M16-1](#). Examples

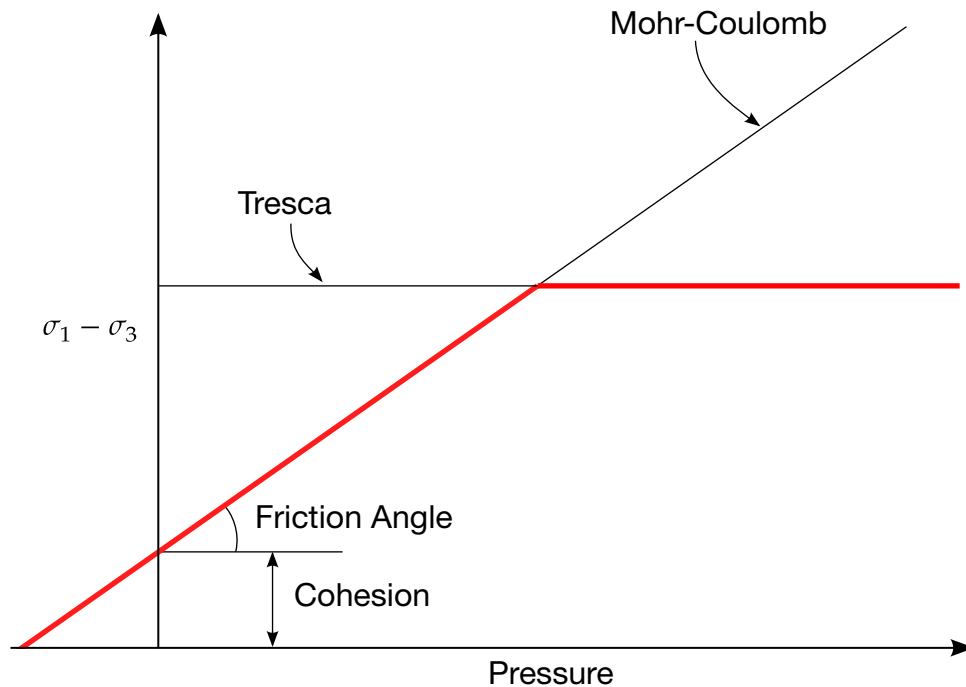

Figure M16-1. Mohr-Coulomb surface with a Tresca Limit.

of converting conventional triaxial compression data to this type of model are found in Desai and Siriwardane, 1984. Note that under conventional triaxial compression conditions, the LS-DYNA input corresponds to an ordinate of $\sigma_1 - \sigma_3$ rather than the more widely used $(\sigma_1 - \sigma_3)/2$, where σ_1 is the maximum principal stress and σ_3 is the minimum principal stress.

This material combined with equation-of-state type 9 (saturated) has been used very successfully to model ground shocks and soil-structure interactions at pressures up to 100 kbars (approximately 1.5×10^6 psi).

To invoke Mode I of this model, set $a_0, a_1, a_2, b_1, a_{0f}$, and a_{1f} to zero. The tabulated values of pressure should then be specified on Cards 4 and 5, and the corresponding values of yield stress should be specified on Cards 6 and 7. The parameters relating to reinforcement properties, initial yield stress, and tangent modulus are not used in this response mode and should be set to zero.

Note that a_{1f} is reset internally to $1/3$ even though it is input as zero; this defines a failed material curve of slope $3p$, where p denotes pressure (positive in compression). In this case the yield strength is taken from the tabulated yield as a function of pressure curve until the maximum principal stress (σ_1) in the element exceeds the tensile cutoff σ_{cut} (input as variable SIGF). When $\sigma_1 > \sigma_{cut}$ is detected, the yield strength is scaled back by a fraction of the distance between the two curves in each of the next 20 time steps so that after those 20 time steps, the yield strength is defined by the failure curve. The only way to inhibit this feature is to set σ_{cut} (SIGF) arbitrarily large.

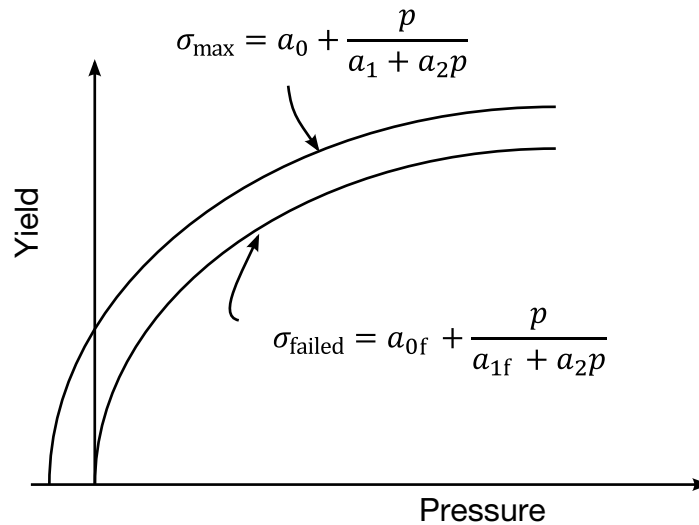

Figure M16-2. Two-curve concrete model with damage and failure

2. **Response Mode II (Two Curve Model with Damage and Failure).** This approach uses two yield versus pressure curves of the form

$$\sigma_y = a_0 + \frac{p}{a_1 + a_2 p}$$

The upper curve is best described as the maximum yield strength curve and the lower curve is the failed material curve. There are a variety of ways of moving between the two curves and each is discussed below.

- a) *Mode II.A (Simple Tensile Failure).* To use this mode, define a_0 , a_1 , a_2 , a_{0f} , and a_{1f} , set b_1 to zero, and leave Cards 4 through 7 blank. In this case the yield strength is taken from the maximum yield curve until the maximum principal stress (σ_1) in the element exceeds the tensile cutoff (σ_{cut}). When $\sigma_1 > \sigma_{cut}$ is detected, the yield strength is scaled back by a fraction of the distance between the two curves in each of the next 20 time steps so that after those 20 time steps, the yield strength is defined by the failure curve.
- b) *Mode II.B (Tensile Failure plus Plastic Strain Scaling).* Define a_0 , a_1 , a_2 , a_{0f} , and a_{1f} , set b_1 to zero, and use Cards 4 through 7 to define a scale factor, η , (Cards 6 and 7) as a function of effective plastic strain (Cards 4 and 5). LS-DYNA evaluates η at the current effective plastic strain and then calculates the yield stress as

$$\sigma_{yield} = \sigma_{failed} + \eta(\sigma_{max} - \sigma_{failed}),$$

where σ_{max} and σ_{failed} are found as shown in [Figure M16-2](#). This yield strength is then subject to scaling for tensile failure as described above. This type of model describes a strain hardening or softening material, such as concrete.

- c) *Model II.C (Tensile Failure plus Damage Scaling)*. The change in yield stress as a function of plastic strain arises from the physical mechanisms such as internal cracking, and the extent of this cracking is affected by the hydrostatic pressure when the cracking occurs. This mechanism gives rise to the "confinement" effect on concrete behavior. To account for this phenomenon, a "damage" function was defined and incorporated. This damage function is given the form:

$$\lambda = \int_0^{\epsilon^p} \left(1 + \frac{p}{\sigma_{\text{cut}}}\right)^{-b_1} d\epsilon^p .$$

To use this model, define a_0 , a_1 , a_2 , a_{0f} , a_{1f} , and b_1 . Cards 4 through 7 now give η as a function of λ . η scales the yield stress as

$$\sigma_{\text{yield}} = \sigma_{\text{failed}} + \eta(\sigma_{\text{max}} - \sigma_{\text{failed}})$$

before applying any tensile failure criteria.

3. **Mode II Concrete Model Options.** Material Type 16 Mode II provides for the automatic internal generation of a simple "generic" model from concrete. If A0 is negative, then SIGF is assumed to be the unconfined concrete compressive strength, f'_c , and $-A0$ is assumed to be a conversion factor from LS-DYNA pressure units to psi. (For example, if the model stress units are MPa, A0 should be set to -145 .) In this case the parameter values generated internally are

$$\begin{aligned} f'_c &= \text{SIGF} & a_1 &= \frac{1}{3} & a_{0f} &= 0 \\ \sigma_{\text{cut}} &= 1.7 \left(\frac{f_c'^2}{-A0} \right)^{\frac{1}{3}} & a_2 &= \frac{1}{3f'_c} & a_{1f} &= 0.385 \\ a_0 &= \frac{f'_c}{4} \end{aligned}$$

Note that these a_{0f} and a_{1f} defaults will be overridden by non-zero entries on Card 3. If plastic strain or damage scaling is desired, Cards 5 through 8 as well as b_1 should be specified in the input. When a_0 is input as a negative quantity, the equation-of-state can be given as 0 and a trilinear EOS Type 8 model will be automatically generated from the unconfined compressive strength and Poisson's ratio. The EOS 8 model is a simple pressure as a function of volumetric strain model with no internal energy terms, and should give reasonable results for pressures up to 5 kbar (approximately 75,000 psi).

4. **Mixture Model.** A reinforcement fraction, f_r , can be defined (indirectly as PER/100) along with properties of the reinforcement material. The bulk

modulus, shear modulus, and yield strength are then calculated from a simple mixture rule. For example, for the bulk modulus the rule gives:

$$K = (1 - f_r)K_m + f_rK_r ,$$

where K_m and K_r are the bulk moduli for the geologic material and the reinforcement material, respectively. This feature should be used with caution. It gives an isotropic effect in the material instead of the true anisotropic material behavior. A reasonable approach would be to use the mixture elements only where the reinforcing exists and plain elements elsewhere. When the mixture model is being used, the strain rate multiplier for the principal material is taken from load curve N1 and the multiplier for the reinforcement is taken from load curve N2.

- 5. **Suggested Parameters.** The LLNL DYNA3D manual from 1991 [Whirley and Hallquist] suggests using the damage function (Mode II.C) in Material Type 16 with the following set of parameters:

$$\begin{array}{lll}
 a_0 = \frac{f'_c}{4} & a_2 = \frac{1}{3f'_c} & a_{1f} = 1.5 \\
 a_1 = \frac{1}{3} & a_{0f} = \frac{f'_c}{10} & b_1 = 1.25
 \end{array}$$

and a damage table of:

Card 4:	0.0 5.17E-04	8.62E-06 6.38E-04	2.15E-05 7.98E-04	3.14E-05	3.95E-04
Card 5:	9.67E-04 4.00E-03	1.41E-03 4.79E-03	1.97E-03 0.909	2.59E-03	3.27E-03
Card 6:	0.309 0.790	0.543 0.630	0.840 0.469	0.975	1.000
Card 7:	0.383 0.086	0.247 0.056	0.173 0.0	0.136	0.114

This set of parameters should give results consistent with Dilger, Koch, and Kowalczyk [1984] for plane concrete. It has been successfully used for reinforced structures where the reinforcing bars were modeled explicitly with embedded beam and shell elements. The model does not incorporate the major failure mechanism - separation of the concrete and reinforcement leading to catastrophic loss of confinement pressure. However, experience indicates that this physical behavior will occur when this model shows about 4% strain.

***MAT_ORIENTED_CRACK**

This is Material Type 17. This material may be used to model brittle materials which fail due to large tensile stresses.

Card 1	1	2	3	4	5	6	7	8
Variable	MID	RO	E	PR	SIGY	ETAN	FS	PRF
Type	A	F	F	F	F	F	F	F
Default	none	none	none	none	none	0.0	none	0.0

Crack Propagation Card. Optional card for crack propagation to adjacent elements (see remarks).

Card 2	1	2	3	4	5	6	7	8
Variable	SOFT	CVELO						
Type	F	F						
Default	1.0	0.0						

VARIABLE**DESCRIPTION**

MID	Material identification. A unique number or label must be specified (see *PART).
RO	Mass density
E	Young's modulus
PR	Poisson's ratio
SIGY	Yield stress
ETAN	Plastic hardening modulus
FS	Fracture stress
PRF	Failure or cutoff pressure (≤ 0.0)

VARIABLE	DESCRIPTION
SOFT	Factor by which the fracture stress is reduced when a crack is coming from failed neighboring element. See remarks.
CVELO	Crack propagation velocity. See remarks.

Remarks:

This is an isotropic elastic-plastic material which includes a failure model with an oriented crack. The von Mises yield condition is given by:

$$\phi = J_2 - \frac{\sigma_y^2}{3} ,$$

where the second stress invariant, J_2 , is defined in terms of the deviatoric stress components as

$$J_2 = \frac{1}{2} s_{ij} s_{ij} ,$$

and the yield stress, σ_y , is a function of the effective plastic strain, ϵ_{eff}^p , and the plastic hardening modulus, E_p :

$$\sigma_y = \sigma_0 + E_p \epsilon_{\text{eff}}^p .$$

The effective plastic strain is defined as:

$$\epsilon_{\text{eff}}^p = \int_0^t d\epsilon_{\text{eff}}^p ,$$

where

$$d\epsilon_{\text{eff}}^p = \sqrt{\frac{2}{3} d\epsilon_{ij}^p d\epsilon_{ij}^p}$$

and the plastic tangent modulus is defined in terms of the input tangent modulus, E_t , as

$$E_p = \frac{E E_t}{E - E_t} .$$

Pressure in this model is found from evaluating an equation of state. A pressure cutoff can be defined such that the pressure is not allowed to fall below the cutoff value.

The oriented crack fracture model is based on a maximum principal stress criterion. When the maximum principal stress exceeds the fracture stress, σ_f , the element fails on a plane perpendicular to the direction of the maximum principal stress. The normal stress and the two shear stresses on that plane are then reduced to zero. This stress reduction is done according to a delay function that reduces the stresses gradually to zero over a small number of time steps. This delay function procedure is used to reduce the ringing

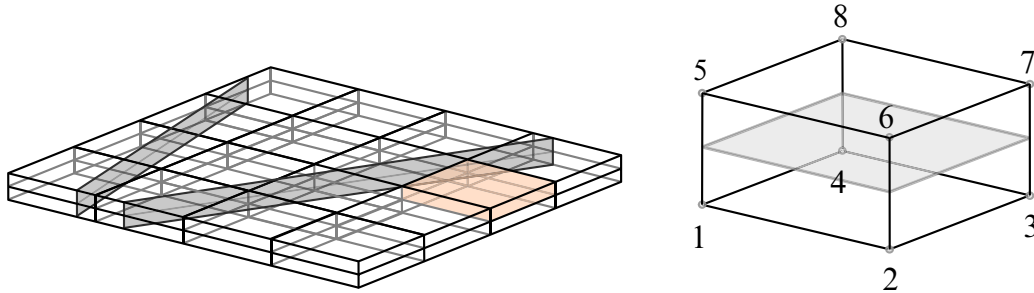

Figure M17-1. Thin structure (2 elements over thickness) with cracks and necessary element numbering.

that may otherwise be introduced into the system by the sudden fracture. The number of steps for stress reduction is 20 by default ($CVELO = 0.0$) or it is internally computed if $CVELO > 0.0$ is given, that is:

$$n_{\text{steps}} = \text{int} \left[\frac{L_e}{CVELO \times \Delta t} \right],$$

where L_e is the characteristic element length and Δt is the time step size.

After a tensile fracture, the element will not support tensile stress on the fracture plane, but in compression will support both normal and shear stresses. The orientation of this fracture surface is tracked throughout the deformation and is updated to properly model finite deformation effects. If the maximum principal stress subsequently exceeds the fracture stress in another direction, the element fails isotropically. In this case the element completely loses its ability to support any shear stress or hydrostatic tension, and only compressive hydrostatic stress states are possible. Thus, once isotropic failure has occurred, the material behaves like a fluid.

This model is applicable to elastic or elastoplastic materials under significant tensile or shear loading when fracture is expected. Potential applications include brittle materials such as ceramics as well as porous materials such as concrete in cases where pressure hardening effects are not significant.

Crack propagation behavior to adjacent elements can be controlled using parameter SOFT for thin, shell-like structures (for example, only 2 or 3 solids over thickness). Additionally, LS-DYNA must know where the plane or solid element midplane is at each integration point for projection of crack plane on this element midplane. Therefore, element numbering must be as shown in [Figure M17-1](#). Currently, only solid element type 1 is supported with that option.

***MAT_POWER_LAW_PLASTICITY**

This is Material Type 18. This is an isotropic plasticity model with rate effects which uses a power law hardening rule.

Card 1	1	2	3	4	5	6	7	8
Variable	MID	RO	E	PR	K	N	SRC	SRP
Type	A	F	F	F	F	F	F	F
Default	none	none	none	none	none	none	0.0	0.0

Card 2	1	2	3	4	5	6	7	8
Variable	SIGY	VP	EPSF					
Type	F	F	F					
Default	0.0	0.0	0.0					

VARIABLE**DESCRIPTION**

MID	Material identification. A unique number or label must be specified (see *PART).
RO	Mass density
E	Young's modulus
PR	Poisson's ratio
K	Strength coefficient
N	Hardening exponent
SRC	Strain rate parameter, <i>C</i> . If zero, rate effects are ignored.
SRP	Strain rate parameter, <i>P</i> . If zero, rate effects are ignored.

VARIABLE	DESCRIPTION
SIGY	Optional input parameter for defining the initial yield stress, σ_y . Generally, this parameter is not necessary and the strain to yield is calculated as described below. LT.0.02: $\varepsilon_{yp} = \text{SIGY}$ GT.0.02: see remarks below.
EPSF	Plastic failure strain for element deletion
VP	Formulation for rate effects: EQ.0.0: scale yield stress (default) EQ.1.0: viscoplastic formulation

Remarks:

Elastoplastic behavior with isotropic hardening is provided by this model. The yield stress, σ_y , is a function of plastic strain and obeys the equation:

$$\sigma_y = k\varepsilon^n = k(\varepsilon_{yp} + \bar{\varepsilon}^p)^n ,$$

where ε_{yp} is the elastic strain to yield and $\bar{\varepsilon}^p$ is the effective plastic strain (logarithmic). If SIGY is set to zero, the strain to yield is found by solving for the intersection of the linearly elastic loading equation with the strain hardening equation:

$$\begin{aligned} \sigma &= E\varepsilon \\ \sigma &= k\varepsilon^n \end{aligned}$$

which gives the elastic strain at yield as:

$$\varepsilon_{yp} = \left(\frac{E}{k}\right)^{\left[\frac{1}{n-1}\right]} .$$

If SIGY is nonzero and greater than 0.02 then:

$$\varepsilon_{yp} = \left(\frac{\sigma_y}{k}\right)^{\left[\frac{1}{n}\right]} .$$

Strain rate is accounted for using the Cowper and Symonds model which scales the yield stress with the factor

$$1 + \left(\frac{\dot{\varepsilon}}{C}\right)^{1/p} .$$

where $\dot{\varepsilon}$ is the strain rate. A fully viscoplastic formulation is optional which incorporates the Cowper and Symonds formulation within the yield surface. An additional cost is incurred but the improvement in results can be dramatic.

***MAT_STRAIN_RATE_DEPENDENT_PLASTICITY**

This is Material Type 19. A strain rate dependent material can be defined. For an alternative, see Material Type 24. A curve for the yield strength as a function of the effective strain rate must be defined. Optionally, Young's modulus and the tangent modulus can also be defined as a function of the effective strain rate. Also, optional failure of the material can be defined either by defining a von Mises stress at failure as a function of the effective strain rate (valid for solids/shells/thick shells) or by defining a minimum time step size (only for shells).

Card 1	1	2	3	4	5	6	7	8
Variable	MID	RO	E	PR	VP			
Type	A	F	F	F	F			
Default	none	none	none	none	0.0			

Card 2	1	2	3	4	5	6	7	8
Variable	LC1	ETAN	LC2	LC3	LC4	TDEL	RDEF	
Type	F	F	F	F	F	F	F	
Default	none	0.0	0.0	0.0	0.0	0.0	0.0	

VARIABLE**DESCRIPTION**

MID	Material identification. A unique number or label must be specified (see *PART).
RO	Mass density
E	Young's modulus
PR	Poisson's ratio
VP	Formulation for rate effects: EQ.0.0: scale yield stress (default) EQ.1.0: viscoplastic formulation

VARIABLE	DESCRIPTION
LC1	Load curve ID defining the yield strength σ_0 as a function of the effective strain rate.
ETAN	Tangent modulus, E_t
LC2	Optional load curve ID defining Young's modulus as a function of the effective strain rate (available only when VP = 0; not recommended).
LC3	Load curve ID defining tangent modulus as a function of the effective strain rate (optional)
LC4	Load curve ID defining von Mises stress at failure as a function of the effective strain rate (optional)
TDEL	Minimum time step size for automatic element deletion. Use for shells only.
RDEF	Redefinition of failure curve: EQ.1.0: effective plastic strain EQ.2.0: maximum principal stress and absolute value of minimum principal stress EQ.3.0: maximum principal stress (R5 of version 971)

Remarks:

- Yield Stress.** In this model, a load curve is used to describe the yield strength σ_0 as a function of effective strain rate $\dot{\bar{\epsilon}}$ where

$$\dot{\bar{\epsilon}} = \left(\frac{2}{3} \dot{\epsilon}'_{ij} \dot{\epsilon}'_{ij} \right)^{1/2}$$

and the prime denotes the deviatoric component. The strain rate is available for post-processing as the first stored history variable. If the viscoplastic option is active, the plastic strain rate is output; otherwise, the effective strain rate defined above is output.

The yield stress is defined as

$$\sigma_y = \sigma_0(\dot{\bar{\epsilon}}) + E_p \bar{\epsilon}^p ,$$

where $\bar{\epsilon}^p$ is the effective plastic strain and E_p is given in terms of Young's modulus and the tangent modulus by

$$E_p = \frac{EE_t}{E - E_t} .$$

Both the Young's modulus and the tangent modulus may optionally be made functions of strain rate by specifying a load curve ID giving their values as a function of strain rate. If these load curve IDs are input as 0, then the constant values specified in the input are used.

2. **Load Curves.** Note that all load curves used to define quantities as a function of strain rate must have the same number of points at the same strain rate values. This requirement is used to allow vectorized interpolation to enhance the execution speed of this constitutive model.
3. **Material Failure.** This model also contains a simple mechanism for modeling material failure. This option is activated by specifying a load curve ID defining the effective stress at failure as a function of strain rate. For solid elements, once the effective stress exceeds the failure stress the element is deemed to have failed and is removed from the solution. For shell elements the entire shell element is deemed to have failed if all integration points through the thickness have an effective stress that exceeds the failure stress. After failure the shell element is removed from the solution.

In addition to the above failure criterion, this material model also supports a shell element deletion criterion based on the maximum stable time step size for the element, Δt_{\max} . Generally, Δt_{\max} goes down as the element becomes more distorted. To assure stability of time integration, the global LS-DYNA time step is the minimum of the Δt_{\max} values calculated for all elements in the model. Using this option allows the selective deletion of elements whose time step Δt_{\max} has fallen below the specified minimum time step, Δt_{crit} . Elements which are severely distorted often indicate that material has failed and supports little load, but these same elements may have very small time steps and therefore control the cost of the analysis. This option allows these highly distorted elements to be deleted from the calculation, and, therefore, the analysis can proceed at a larger time step, and, thus, at a reduced cost. Deleted elements do not carry any load and are deleted from all applicable slide surface definitions. Clearly, this option must be judiciously used to obtain accurate results at a minimum cost.

4. **Viscoplastic Formulation.** A fully viscoplastic formulation is optional which incorporates the rate formulation within the yield surface. An additional cost is incurred but the improvement in results can be dramatic.

*MAT_RIGID

This is Material Type 20. Parts made from this material are considered to belong to a rigid body (for each part ID). The coupling of a rigid body with MADYMO and CAL3D can also be defined using this material. Alternatively, a VDA surface can be attached as surface to model the geometry, such as for the tooling in metal forming applications. Optional global and local constraints on the mass center can be defined. A local consideration for output and user-defined airbag sensors may also optionally be chosen.

Card Summary:

Card 1. This card is required.

MID	RO	E	PR	N	COUPLE	M	ALIAS or RE
-----	----	---	----	---	--------	---	-------------

Card 2a. This card is included if CMO = 1.0.

CMO	CON1	CON2					
-----	------	------	--	--	--	--	--

Card 2b. This card is included if CMO = 0.0

CMO							
-----	--	--	--	--	--	--	--

Card 2c. This card is included if CMO = -1.0.

CMO	CON1	CON2					
-----	------	------	--	--	--	--	--

Card 3. This card is must be included but may be left blank.

LCO or A1	A2	A3	V1	V2	V3		
-----------	----	----	----	----	----	--	--

Data Card Definitions:

Card 1	1	2	3	4	5	6	7	8
Variable	MID	RO	E	PR	N	COUPLE	M	ALIAS or RE
Type	A	F	F	F	F	F	F	C/F
Default	none	none	none	none	0	0	0	opt none

VARIABLE**DESCRIPTION**

MID	Material identification. A unique number or label must be specified (see *PART).
RO	Mass density
E	Young's modulus. Reasonable values must be chosen for contact analysis (choice of penalty); see Remarks below.
PR	Poisson's ratio. Reasonable values must be chosen for contact analysis (choice of penalty); see Remarks below.
N	MADYMO3D 5.4 coupling flag, <i>n</i> : EQ.0: use normal LS-DYNA rigid body updates. GT.0: the rigid body is coupled to the MADYMO 5.4 ellipsoid number <i>n</i> . LT.0: the rigid body is coupled to MADYMO 5.4 plane number, <i> n </i> .
COUPLE	Coupling option if applicable: EQ.-1: attach VDA surface in ALIAS (defined in the eighth field) and automatically generate a mesh for viewing the surface in LS-PREPOST. MADYMO 5.4 / CAL3D coupling option: EQ.0: the undeformed geometry input to LS-DYNA corresponds to the local system for MADYMO 5.4 / CAL3D. The finite element mesh is input.

VARIABLE	DESCRIPTION
	EQ.1: the undeformed geometry input to LS-DYNA corresponds to the global system for MADYMO 5.4 / CAL3D. EQ.2: generate a mesh for the ellipsoids and planes internally in LS-DYNA.
M	MADYMO3D 5.4 coupling flag, <i>m</i> : EQ.0: use normal LS-DYNA rigid body updates, EQ. <i>m</i> : this rigid body corresponds to the MADYMO rigid body number, <i>m</i> . Rigid body updates are performed by MADYMO.
ALIAS	VDA surface alias name; see Appendix L.
RE	MADYMO 6.0.1 External Reference Number

Global Constraints Card. This card is included if CMO = 1.0.

Card 2a	1	2	3	4	5	6	7	8
Variable	CMO	CON1	CON2					
Type	F	I	I					
Default	0.0	0	0					

VARIABLE	DESCRIPTION
CMO	Center of mass constraint option, CMO: EQ.+1.0: constraints applied in global directions EQ.0.0: no constraints EQ.-1.0: constraints applied in local directions (SPC constraint)
CON1	Global translational constraint: EQ.0: no constraints EQ.1: constrained <i>x</i> displacement EQ.2: constrained <i>y</i> displacement EQ.3: constrained <i>z</i> displacement

VARIABLE	DESCRIPTION
	EQ.4: constrained x and y displacements EQ.5: constrained y and z displacements EQ.6: constrained z and x displacements EQ.7: constrained $x, y,$ and z displacements
CON2	Global rotational constraint: EQ.0: no constraints EQ.1: constrained x rotation EQ.2: constrained y rotation EQ.3: constrained z rotation EQ.4: constrained x and y rotations EQ.5: constrained y and z rotations EQ.6: constrained z and x rotations EQ.7: constrained $x, y,$ and z rotations

No Constraints Card. This card is included when CMO = 0.0.

Card 2b	1	2	3	4	5	6	7	8
Variable	CMO							
Type	F							
Default	0.0							

VARIABLE	DESCRIPTION
CMO	Center of mass constraint option, CMO: EQ.+1.0: constraints applied in global directions EQ.0.0: no constraints EQ.-1.0: constraints applied in local directions (SPC constraint)

Local Constraints Card. This card is included when CMO = -1.0.

Card 2c	1	2	3	4	5	6	7	8
Variable	CMO	CON1	CON2					
Type	F	I	I					
Default	0.0	0	0					

VARIABLE

DESCRIPTION

CMO Center of mass constraint option, CMO:
 EQ.+1.0: constraints applied in global directions
 EQ.0.0: no constraints
 EQ.-1.0: constraints applied in local directions (SPC constraint)

CON1 Local coordinate system ID. See *DEFINE_COORDINATE_OPTION. This coordinate system is fixed in time, unless rotation is prescribed with *BOUNDARY_PRESCRIBED_MOTION_RIGID_LOCAL (see Remark 5).

CON2 Local (SPC) constraint:
 EQ.000000: no constraint
 EQ.100000: constrained x translation
 EQ.010000: constrained y translation
 EQ.001000: constrained z translation
 EQ.000100: constrained x rotation
 EQ.000010: constrained y rotation
 EQ.000001: constrained z rotation

Any combination of local constraints can be specified by adding the number 1 into the corresponding column.

Optional for output (Must be included but may be left blank).

Card 3	1	2	3	4	5	6	7	8
Variable	LCO or A1	A2	A3	V1	V2	V3		
Type	F	F	F	F	F	F		
Default	0	0	0	0	0	0		

VARIABLE

DESCRIPTION

LCO

Local coordinate system number for local output to rbdout. LCO also specifies the coordinate system used for *BOUNDARY_PRESCRIBED_MOTION_RIGID_LOCAL. Defaults to the principal coordinate system of the rigid body.

A1 - V3

Alternative method for specifying local system below:

Define two vectors **a** and **v**, fixed to the rigid body which are used for output and the user defined airbag sensor subroutines. The output parameters are in the directions **a**, **b**, and **c** where the latter are given by the cross products $\mathbf{c} = \mathbf{a} \times \mathbf{v}$ and $\mathbf{b} = \mathbf{c} \times \mathbf{a}$. This input is optional.

Remarks:

- Rigid Material.** The rigid material type 20 provides a convenient way of turning one or more parts comprised of beams, shells, or solid elements into a rigid body. Approximating a deformable body as rigid is a preferred modeling technique in many real world applications. For example, in sheet metal forming problems the tooling can properly and accurately be treated as rigid. In the design of restraint systems the occupant can, for the purposes of early design studies, also be treated as rigid. Elements which are rigid are bypassed in the element processing and no storage is allocated for storing history variables; consequently, the rigid material type is very cost efficient.
- Parts.** Two unique rigid part IDs may not share common nodes unless they are merged together using the rigid body merge option. A rigid body, however, may be made up of disjoint finite element meshes. LS-DYNA assumes this is the case since this is a common practice in setting up tooling meshes in forming problems.

All elements which reference a given part ID corresponding to the rigid material should be contiguous, but this is not a requirement. If two disjoint groups of elements on opposite sides of a model are modeled as rigid, separate part IDs should be created for each of the contiguous element groups if each group is to move independently. This requirement arises from the fact that LS-DYNA internally computes the six rigid body degrees-of-freedom for each rigid body (rigid material or set of merged materials), and if disjoint groups of rigid elements use the same part ID, the disjoint groups will move together as one rigid body.

- Inertial Properties.** Inertial properties for rigid materials may be defined in either of two ways. By default, the inertial properties are calculated from the geometry of the constituent elements of the rigid material and the density specified for the part ID. Alternatively, the inertial properties and initial velocities for a rigid body may be directly defined, and this overrides data calculated from the material property definition and nodal initial velocity definitions.
- Contact and Material Constants.** Young's modulus, E , and Poisson's ratio, ν , are used for determining sliding interface parameters if the rigid body interacts in a contact definition. Realistic values for these constants should be defined since unrealistic values may contribute to numerical problems with contact.
- Constraints.** Constraint directions for rigid materials (CMO equal to +1 or -1) are fixed, that is, not updated, with time. To impose a constraint on a rigid body such that the constraint direction is updated as the rigid body rotates, use *BOUNDARY_PRESCRIBED_MOTION_RIGID_LOCAL. When CMO is equal to -1 and *BOUNDARY_PRESCRIBED_MOTION_RIGID_LOCAL is used, the loc coordinate system CON1 is updated with time.

We strongly advise you not to apply nodal constraints, for instance, by *BOUNDARY_SPC_OPTION, to nodes of a rigid body as doing so may compromise the intended constraints in the case of an explicit simulation. Such SPCs will be skipped in an implicit simulation and a warning issued.

If the intended constraints are not with respect to the calculated center-of-mass of the rigid body, *CONSTRAINED_JOINT_OPTION may often be used to obtain the desired effect. This approach typically entails defining a second rigid body which is fully constrained and then defining a joint between the two rigid bodies. Another alternative for defining rigid body constraints that are not with respect to the calculated center-of-mass of the rigid body is to manually specify the initial center-of-mass location using *PART_INERTIA. When using *PART_INERTIA, a full set of mass properties must be specified. Note that the dynamic behavior of the rigid body, however, is affected by its mass properties.

- Coupling with MADYMO.** Only basic coupling is available for coupling with MADYMO 5.4.1. The coupling flags (N and M) must match with SYSTEM and

ELLIPSOID/PLANE in the MADYMO input file and the coupling option (COUPLE) must be defined.

Both basic and extended coupling are available for coupling with MADYMO 6.0.1:

- a) *Basic Coupling.* The external reference number (RE) must match the external reference number in the MADYMO XML input file. The coupling option (COUPLE) must be defined.
- b) *Extended Coupling.* Under this option MADYMO will handle the contact between the MADYMO and LS-DYNA models. The external reference number (RE) and the coupling option (COUPLE) are not needed. All coupling surfaces that interface with the MADYMO models need to be defined in *CONTACT_COUPLING.

*MAT_ORTHOTROPIC_THERMAL_{OPTION}

This is Material Type 21. It is a linearly elastic, orthotropic material with orthotropic thermal expansion. It is available for solids, shells, and thick shells.

Available options include:

- <BLANK>
- FAILURE
- CURING

Card Summary:

Card 1. This card is required.

MID	RO	EA	EB	EC	PRBA	PRCA	PRCB
-----	----	----	----	----	------	------	------

Card 2. This card is required.

GAB	GBC	GCA	AA	AB	AC	AOPT	MACF
-----	-----	-----	----	----	----	------	------

Card 3. This card is required.

XP	YP	ZP	A1	A2	A3		
----	----	----	----	----	----	--	--

Card 4. This card is required.

V1	V2	V3	D1	D2	D3	BETA	REF
----	----	----	----	----	----	------	-----

Card 5a. This card is included if and only if the keyword option FAILURE is used.

A1	A11	A2	A5	A55	A4	NIP	
----	-----	----	----	-----	----	-----	--

Card 5b.1. This card is included if and only if the keyword option CURING is used.

K1	K2	C1	C2	M	N	R	
----	----	----	----	---	---	---	--

Card 5b.2. This card is included if and only if the keyword option CURING is used.

LCCHA	LCCHB	LCCHC	LCAA	LCAB	LCAC		
-------	-------	-------	------	------	------	--	--

Data Card Definitions:

Card 1	1	2	3	4	5	6	7	8
Variable	MID	RO	EA	EB	EC	PRBA	PRCA	PRCB
Type	A	F	F	F	F	F	F	F

VARIABLE**DESCRIPTION**

MID	Material identification. A unique number or label must be specified (see *PART).
RO	Mass density
EA	E_a , Young's modulus in a -direction
EB	E_b , Young's modulus in b -direction
EC	E_c , Young's modulus in c -direction
PRBA	ν_{ba} , Poisson's ratio, ba
PRCA	ν_{ca} , Poisson's ratio, ca
PRCB	ν_{cb} , Poisson's ratio, cb

Card 2	1	2	3	4	5	6	7	8
Variable	GAB	GBC	GCA	AA	AB	AC	AOPT	MACF
Type	F	F	F	F	F	F	F	I

VARIABLE**DESCRIPTION**

GAB	G_{ab} , Shear modulus, ab
GBC	G_{bc} , Shear modulus, bc
GCA	G_{ca} , Shear modulus, ca
AA	α_a , coefficient of thermal expansion in the a -direction

VARIABLE	DESCRIPTION
AB	α_b , coefficient of thermal expansion in the b -direction
AC	α_c , coefficient of thermal expansion in the c -direction
AOPT	Material axes option (see MAT_OPTIONTROPIC_ELASTIC, particularly the Material Directions section, for details): <p data-bbox="521 499 1425 688">EQ.0.0: Locally orthotropic with material axes determined by element nodes 1, 2, and 4, as with *DEFINE_COORDINATE_NODES. For shells only, the material axes are then rotated about the normal vector to the surface of the shell by the angle BETA.</p> <p data-bbox="521 711 1425 858">EQ.1.0: Locally orthotropic with material axes determined by a point, P, in space and the global location of the element center; this is the \mathbf{a}-direction. This option is for solid elements only.</p> <p data-bbox="521 882 1425 989">EQ.2.0: Globally orthotropic with material axes determined by vectors defined below, as with *DEFINE_COORDINATE_VECTOR</p> <p data-bbox="521 1012 1425 1633">EQ.3.0: Locally orthotropic material axes determined by a vector \mathbf{v} and the normal vector to the plane of the element. The plane of a solid element is the midsurface between the inner surface and outer surface defined by the first four nodes and the last four nodes of the connectivity of the element, respectively. Thus, for solid elements, AOPT = 3 is only available for hexahedrons. \mathbf{a} is determined by taking the cross product of \mathbf{v} with the normal vector, \mathbf{b} is determined by taking the cross product of the normal vector with \mathbf{a}, and \mathbf{c} is the normal vector. Then \mathbf{a} and \mathbf{b} are rotated about \mathbf{c} by an angle BETA. BETA may be set in the keyword input for the element or in the input for this keyword. Note that for solids, the material axes may be switched depending on the choice of MACF. The switch may occur before or after applying BETA depending on the value of MACF.</p> <p data-bbox="521 1656 1425 1806">EQ.4.0: Locally orthotropic in a cylindrical coordinate system with the material axes determined by a vector \mathbf{v}, and an originating point, P, which define the centerline axis. This option is for solid elements only.</p> <p data-bbox="521 1829 1425 1902">LT.0.0: The absolute value of AOPT is a coordinate system ID number (CID on *DEFINE_COORDINATE_OPTION).</p>

VARIABLE	DESCRIPTION
----------	-------------

MACF Material axes change flag for solid elements:

EQ.-4: Switch material axes *b* and *c* before BETA rotation
 EQ.-3: Switch material axes *a* and *c* before BETA rotation
 EQ.-2: Switch material axes *a* and *b* before BETA rotation
 EQ.1: No change, default
 EQ.2: Switch material axes *a* and *b* after BETA rotation
 EQ.3: Switch material axes *a* and *c* after BETA rotation
 EQ.4: Switch material axes *b* and *c* after BETA rotation

Figure M2-2 indicates when LS-DYNA applies MACF during the process to obtain the final material axes. If BETA on *ELEMENT_-SOLID_{OPTION} is defined, then that BETA is used for the rotation for all AOPT options. Otherwise, if AOPT = 3, the BETA input on Card 4 rotates the axes. For all other values of AOPT, the material axes will be switched as specified by MACF, but no BETA rotation will be performed.

Card 3	1	2	3	4	5	6	7	8
Variable	XP	YP	ZP	A1	A2	A3		
Type	F	F	F	F	F	F		

VARIABLE	DESCRIPTION
----------	-------------

XP, YP, ZP Coordinates of point *p* for AOPT = 1 and 4

A1, A2, A3 Components of vector **a** for AOPT = 2

Card 4	1	2	3	4	5	6	7	8
Variable	V1	V2	V3	D1	D2	D3	BETA	REF
Type	F	F	F	F	F	F	F	

VARIABLE	DESCRIPTION
V1, V2, V3	Components of vector v for AOPT = 3 and 4
D1, D2, D3	Components of vector d for AOPT = 2
BETA	Material angle in degrees for AOPT = 0 (shells and tshells only) and AOPT = 3 (all element types). It may be overridden on the element card; see *ELEMENT_SHELL_BETA, *ELEMENT_TSHELL_BETA, or *ELEMENT_SOLID_ORTHO.
REF	Use reference geometry to initialize the stress tensor. The reference geometry is defined by the keyword: *INITIAL_FOAM_REFERENCE_GEOMETRY (see there for more details). EQ.0.0: Off EQ.1.0: On

Failure Card. This card is only included if the FAILURE keyword option is used.

Card 5a	1	2	3	4	5	6	7	8
Variable	A1	A11	A2	A5	A55	A4	NIP	
Type	F	F	F	F	F	F	F	

VARIABLE	DESCRIPTION
A1, A11, A2	Coefficients for the matrix dominated failure criterion
A5, A55, A4	Coefficients for the fiber dominated failure criterion
NIP	Number of integration points that must fail in an element before an element fails and is deleted

Curing Card. This card is included if and only if the CURING keyword option is used.

Card 5b.1	1	2	3	4	5	6	7	8
Variable	K1	K2	C1	C2	M	N	R	
Type	F	F	F	F	F	F	F	

VARIABLE	DESCRIPTION
K1	Parameter k_1 for Kamal model. For details see remarks below.
K2	Parameter k_2 for Kamal model
C1	Parameter c_1 for Kamal model
C2	Parameter c_2 for Kamal model
M	Exponent m for Kamal model
N	Exponent n for Kamal model
R	Gas constant for Kamal model

Curing Card. This card is included if and only if the CURING keyword option is used.

Card 5b.2	1	2	3	4	5	6	7	8
Variable	LCCHA	LCCHB	LCCHC	LCAA	LCAB	LCAC		
Type	I	I	I	I	I	I		

VARIABLE	DESCRIPTION
LCCHA	Load curve for γ_a , coefficient of chemical shrinkage in the a -direction. Input γ_a as function of state of cure β .
LCCHB	Load curve for γ_b , coefficient of chemical shrinkage in the b -direction. Input γ_b as function of state of cure β .
LCCHC	Load curve for γ_c , coefficient of chemical shrinkage in the c -direction. Input γ_c as function of state of cure β .
LCAA	Load curve or table ID for α_a . If defined, parameter AA is ignored. If a load curve, then α_a is a function of temperature. If a table ID, the α_a is a function of the state of cure (table values) and temperature (see*DEFINE_TABLE).
LCAB	Load curve ID for α_b . If defined parameter, AB is ignored. See LCAA for further details.
LCAC	Load curve ID for α_c . If defined parameter, AC is ignored. See LCAA for further details.

Remarks:

In the implementation for three-dimensional continua a total Lagrangian formulation is used. In this approach the material law that relates second Piola-Kirchhoff stress \mathbf{S} to the Green-St. Venant strain \mathbf{E} is

$$\mathbf{S} = \mathbf{C} : \mathbf{E} = \mathbf{T}^T \mathbf{C}_l \mathbf{T} : \mathbf{E}$$

where \mathbf{T} is the transformation matrix [Cook 1974].

$$\mathbf{T} = \begin{bmatrix} l_1^2 & m_1^2 & n_1^2 & l_1 m_1 & m_1 n_1 & n_1 l_1 \\ l_2^2 & m_2^2 & n_2^2 & l_2 m_2 & m_2 n_2 & n_2 l_2 \\ l_3^2 & m_3^2 & n_3^2 & l_3 m_3 & m_3 n_3 & n_3 l_3 \\ 2l_1 l_2 & 2m_1 m_2 & 2n_1 n_2 & (l_1 m_2 + l_2 m_1) & (m_1 n_2 + m_2 n_1) & (n_1 l_2 + n_2 l_1) \\ 2l_2 l_3 & 2m_2 m_3 & 2n_2 n_3 & (l_2 m_3 + l_3 m_2) & (m_2 n_3 + m_3 n_2) & (n_2 l_3 + n_3 l_2) \\ 2l_3 l_1 & 2m_3 m_1 & 2n_3 n_1 & (l_3 m_1 + l_1 m_3) & (m_3 n_1 + m_1 n_3) & (n_3 l_1 + n_1 l_3) \end{bmatrix}$$

l_i, m_i, n_i are the direction cosines

$$x'_i = l_i x_1 + m_i x_2 + n_i x_3 \text{ for } i = 1, 2, 3$$

and x'_i denotes the material axes. The constitutive matrix \mathbf{C}_l is defined in terms of the material axes as

$$\mathbf{C}_l^{-1} = \begin{bmatrix} \frac{1}{E_{11}} & -\frac{\nu_{21}}{E_{22}} & -\frac{\nu_{31}}{E_{33}} & 0 & 0 & 0 \\ -\frac{\nu_{12}}{E_{11}} & \frac{1}{E_{22}} & -\frac{\nu_{32}}{E_{33}} & 0 & 0 & 0 \\ -\frac{\nu_{13}}{E_{11}} & -\frac{\nu_{23}}{E_{22}} & \frac{1}{E_{33}} & 0 & 0 & 0 \\ 0 & 0 & 0 & \frac{1}{G_{12}} & 0 & 0 \\ 0 & 0 & 0 & 0 & \frac{1}{G_{23}} & 0 \\ 0 & 0 & 0 & 0 & 0 & \frac{1}{G_{31}} \end{bmatrix}$$

where the subscripts denote the material axes, meaning

$$\nu_{ij} = \nu_{x'_i x'_j} \quad \text{and} \quad E_{ii} = E_{x'_i}$$

Since \mathbf{C}_l is symmetric

$$\frac{\nu_{12}}{E_{11}} = \frac{\nu_{21}}{E_{22}}, \dots$$

The vector of Green-St. Venant strain components is

$$\mathbf{E}^T = [E_{11}, E_{22}, E_{33}, E_{12}, E_{23}, E_{31}]$$

which include the local thermal strains which are integrated in time:

$$\begin{aligned}\varepsilon_{aa}^{n+1} &= \varepsilon_{aa}^n + \alpha_a (T^{n+1} - T^n) \\ \varepsilon_{bb}^{n+1} &= \varepsilon_{bb}^n + \alpha_b (T^{n+1} - T^n) \\ \varepsilon_{cc}^{n+1} &= \varepsilon_{cc}^n + \alpha_c (T^{n+1} - T^n)\end{aligned}$$

where T is temperature. After computing S_{ij} we then obtain the Cauchy stress:

$$\sigma_{ij} = \frac{\rho}{\rho_0} \frac{\partial x_i}{\partial X_k} \frac{\partial x_j}{\partial X_l} S_{kl}$$

This model will predict realistic behavior for finite displacement and rotations as long as the strains are small.

In the implementation for shell elements, the stresses are integrated in time and are updated in the corotational coordinate system. In this procedure the local material axes are assumed to remain orthogonal in the deformed configuration. This assumption is valid if the strains remain small.

The failure models were derived by William Feng. The first one defines the matrix dominated failure mode,

$$F_m = A_1(I_1 - 3) + A_{11}(I_1 - 3)^2 + A_2(I_2 - 3) - 1 ,$$

and the second defines the fiber dominated failure mode,

$$F_f = A_5(I_5 - 1) + A_{55}(I_5 - 1)^2 + A_4(I_4 - 1) - 1 .$$

When either is greater than zero, the integration point fails, and the element is deleted after NIP integration points fail.

The coefficients A_i are defined in the input and the invariants I_i are the strain invariants

$$\begin{aligned}I_1 &= \sum_{\alpha=1,3} C_{\alpha\alpha} \\ I_2 &= \frac{1}{2} [I_1^2 - \sum_{\alpha,\beta=1,3} C_{\alpha\beta}^2] \\ I_3 &= \det(\mathbf{C}) \\ I_4 &= \sum_{\alpha,\beta,\gamma=1,3} V_\alpha C_{\alpha\gamma} C_{\gamma\beta} V_\beta \\ I_5 &= \sum_{\alpha,\beta=1,3} V_\alpha C_{\alpha\beta} V_\beta\end{aligned}$$

and \mathbf{C} is the Cauchy strain tensor and \mathbf{V} is the fiber direction in the undeformed state. By convention in this material model, the fiber direction is aligned with the a direction of the local orthotropic coordinate system.

The curing option implies that orthotropic chemical shrinkage is to be considered, resulting from a curing process in the material. The state of cure β is an internal material variable that follows the Kamal model

$$\frac{d\beta}{dt} = (K_1 + K_2\beta^m)(1 - \beta)^n \quad \text{with} \quad K_1 = k_1 e^{-\frac{c_1}{RT}}, \quad K_2 = k_2 e^{-\frac{c_2}{RT}}$$

Chemical strains are introduced as:

$$\begin{aligned}\varepsilon_{aa}^{n+1} &= \varepsilon_{aa}^n + \gamma_a(\beta^{n+1} - \beta^n) \\ \varepsilon_{bb}^{n+1} &= \varepsilon_{bb}^n + \gamma_b(\beta^{n+1} - \beta^n) \\ \varepsilon_{cc}^{n+1} &= \varepsilon_{cc}^n + \gamma_c(\beta^{n+1} - \beta^n)\end{aligned}$$

The coefficients, γ_a , γ_b , and γ_c , can be defined as functions of the state of cure β . Furthermore, the coefficients of thermal expansion, α_a , α_b , and α_c , can also be defined as functions of the state of cure, β , and the temperature, T , if the curing option is used.

The current degree of cure as well as the chemical shrinkage in the different directions is output in the history variables. For solid elements it can be found at positions 30 to 33 and for shell elements at positions 22 to 25.

***MAT_COMPOSITE_DAMAGE**

This is Material Type 22. With this model, an orthotropic material with optional brittle failure for composites can be defined following the suggestion of [Chang and Chang 1987a, 1987b]. Failure can be modeled with three criteria; see the LS-DYNA Theory Manual. By using the user defined integration rule (see *INTEGRATION_SHELL), the constitutive constants can vary through the shell thickness.

For all shells, except the DKT formulation, laminated shell theory can be activated to properly model the transverse shear deformation. Lamination theory is applied to correct for the assumption of a uniform constant shear strain through the thickness of the shell. For sandwich shells where the outer layers are much stiffer than the inner layers, the response will tend to be too stiff unless lamination theory is used. To turn on lamination theory, see *CONTROL_SHELL.

This material is available for shells, solids, thick shells, and SPH elements.

Card 1	1	2	3	4	5	6	7	8
Variable	MID	RO	EA	EB	EC	PRBA	PRCA	PRCB
Type	A	F	F	F	F	F	F	F
Default	none	none	none	none	none	none	none	none
Remarks						3	3	3

Card 2	1	2	3	4	5	6	7	8
Variable	GAB	GBC	GCA	KFAIL	AOPT	MACF	ATRACK	
Type	F	F	F	F	F	I	I	
Default	none	none	none	0.0	0.0	0	0	

Card 3	1	2	3	4	5	6	7	8
Variable	XP	YP	ZP	A1	A2	A3		
Type	F	F	F	F	F	F		
Default	0.0	0.0	0.0	0.0	0.0	0.0		

Card 4	1	2	3	4	5	6	7	8
Variable	V1	V2	V3	D1	D2	D3	BETA	
Type	F	F	F	F	F	F	F	
Default	0.0	0.0	0.0	0.0	0.0	0.0	0.0	

Card 5	1	2	3	4	5	6	7	8
Variable	SC	XT	YT	YC	ALPH	SN	SYZ	SZX
Type	F	F	F	F	F	F	F	F
Default	none	none	none	none	none	none	none	none

VARIABLE**DESCRIPTION**

MID	Material identification. A unique number or label must be specified (see *PART).
RO	Mass density
EA	E_a , Young's modulus in a -direction
EB	E_b , Young's modulus in b -direction
EC	E_c , Young's modulus in c -direction
PRBA	ν_{ba} , Poisson ratio, ba

VARIABLE	DESCRIPTION
PRCA	ν_{ca} , Poisson ratio, <i>ca</i>
PRCB	ν_{cb} , Poisson ratio, <i>cb</i>
GAB	G_{ab} , Shear modulus, <i>ab</i>
GBC	G_{bc} , Shear modulus, <i>bc</i>
GCA	G_{ca} , Shear modulus, <i>ca</i>
KFAIL	Bulk modulus of failed material. Necessary for compressive failure.
AOPT	Material axes option (see MAT_OPTIONTROPIC_ELASTIC, particularly the Material Directions section, for details): EQ.0.0: Locally orthotropic with material axes determined by element nodes 1, 2, and 4, as with *DEFINE_COORDINATE_NODES. For shells only, the material axes are then rotated about the normal vector to the surface of the shell by the angle BETA. EQ.1.0: Locally orthotropic with material axes determined by a point, <i>P</i> , in space and the global location of the element center; this is the a -direction. This option is for solid elements only. EQ.2.0: Globally orthotropic with material axes determined by vectors defined below, as with *DEFINE_COORDINATE_VECTOR

VARIABLE	DESCRIPTION
	<p>EQ.3.0: Locally orthotropic material axes determined by a vector \mathbf{v} and the normal vector to the plane of the element. The plane of a solid element is the midsurface between the inner surface and outer surface defined by the first four nodes and the last four nodes of the connectivity of the element, respectively. Thus, for solid elements, AOPT = 3 is only available for hexahedrons. \mathbf{a} is determined by taking the cross product of \mathbf{v} with the normal vector, \mathbf{b} is determined by taking the cross product of the normal vector with \mathbf{a}, and \mathbf{c} is the normal vector. Then \mathbf{a} and \mathbf{b} are rotated about \mathbf{c} by an angle BETA. BETA may be set in the keyword input for the element or in the input for this keyword. Note that for solids, the material axes may be switched depending on the choice of MACF. The switch may occur before or after applying BETA depending on the value of MACF.</p> <p>EQ.4.0: Locally orthotropic in a cylindrical coordinate system with the material axes determined by a vector \mathbf{v}, and an originating point, P, which define the centerline axis. This option is for solid elements only.</p> <p>LT.0.0: The absolute value of AOPT is a coordinate system ID number (CID on *DEFINE_COORDINATE_OPTION).</p>
MACF	<p>Material axes change flag for solid elements:</p> <p>EQ.-4: Switch material axes b and c before BETA rotation</p> <p>EQ.-3: Switch material axes a and c before BETA rotation</p> <p>EQ.-2: Switch material axes a and b before BETA rotation</p> <p>EQ.1: No change, default</p> <p>EQ.2: Switch material axes a and b after BETA rotation</p> <p>EQ.3: Switch material axes a and c after BETA rotation</p> <p>EQ.4: Switch material axes b and c after BETA rotation</p>

Figure M2-2 indicates when LS-DYNA applies MACF during the process to obtain the final material axes. If BETA on *ELEMENT_SOLID_{OPTION} is defined, then that BETA is used for the rotation for all AOPT options. Otherwise, if AOPT = 3, the BETA input on Card 4 rotates the axes. For all other values of AOPT, the material axes will be switched as specified by MACF, but no BETA rotation will be performed.

VARIABLE	DESCRIPTION
ATRACK	Material a -axis tracking flag (shell elements only): EQ.0: a -axis rotates with element (default). EQ.1: a -axis also tracks deformation (see Remark 2).
XP, YP, ZP	Coordinates of point p for AOPT = 1 and 4
A1, A2, A3	Components of vector \mathbf{a} for AOPT = 2
V1, V2, V3	Components of vector \mathbf{v} for AOPT = 3 and 4
D1, D2, D3	Components of vector \mathbf{d} for AOPT = 2
BETA	Material angle in degrees for AOPT = 0 (shells and tshells only) and AOPT = 3. It may be overridden on the element card; see *ELEMENT_SHELL_BETA, *ELEMENT_TSHELL_BETA, or *ELEMENT_SOLID_ORTHO.
SC	Shear strength, ab -plane; see the LS-DYNA Theory Manual.
XT	Longitudinal tensile strength, a -axis; see the LS-DYNA Theory Manual.
YT	Transverse tensile strength, b -axis
YC	Transverse compressive strength, b -axis (positive value)
ALPH	Shear stress parameter for the nonlinear term in units of [stress ³]; see the LS-DYNA Theory Manual.
SN	Normal tensile strength (<i>solid elements only</i>)
SYZ	Transverse shear strength (<i>solid elements only</i>)
SZX	Transverse shear strength (<i>solid elements only</i>)

Remarks:

1. **History Data.** The number of additional integration point variables for shells written to the d3plot database is specified using the *DATABASE_EXTENT_BINARY keyword on the NEIPS field. These additional history variables are enumerated below:

History Variable ⁴	Description	Value	LS-PrePost History Variable
$ef(i)$	tensile fiber mode	1 - elastic 0 - failed	See table below
$cm(i)$	tensile matrix mode		1
$ed(i)$	compressive matrix mode		2

The following components are stored as element component 7 instead of the effective plastic strain. Note that $ef(i)$ for $i = 1,2,3$ is not retrievable.

Description	Integration point
$\frac{1}{nip} \sum_{i=1}^{nip} ef(i)$	1
$\frac{1}{nip} \sum_{i=1}^{nip} cm(i)$	2
$\frac{1}{nip} \sum_{i=1}^{nip} ed(i)$	3
$ef(i)$ for $i > 3$	i

2. **The ATRACK Field.** The initial material directions are set using AOPT and the related data. By default, the material directions in shell elements are updated each cycle based on the rotation of the 1-2 edge, or else the rotation of all edges if the invariant node numbering option is set on *CONTROL_ACCURACY. When ATRACK = 1, an optional scheme is used in which the a -direction of the material tracks element deformation as well as rotation.

At the start of the calculation, a line is passed through each element center in the direction of the material a -axis. This line will intersect the edges of the element at two points. The referential coordinates of these two points are stored and then used throughout the calculation to locate these points in the deformed geometry. The material a -axis is assumed to be in the direction of the line that passes through both points. If ATRACK = 0, the layers of a layered composite will always rotate together. However, if ATRACK = 1, the layers can rotate independently which may be more accurate, particularly for shear deformation. This option is available only for shell elements.

⁴ i ranges over the shell integration points.

- Poisson's Ratio.** If $E_A > E_B$, PR_{BA} is the minor Poisson's ratio if $E_A > E_B$, and the major Poisson's ratio will be equal to $PR_{BA} \times (E_A/E_B)$. If $E_B > E_A$, then PR_{BA} is the major Poisson's ratio. PR_{CA} and PR_{CB} are similarly defined. They are the minor Poisson's ratio if $E_A > E_C$ or $E_B > E_C$, and the major Poisson's ratio if the $E_C > E_A$ or $E_C > E_B$.

Care should be taken when using material parameters from third party products regarding the directional indices a , b and c , as they may differ from the definition used in LS-DYNA. For the direction indices used in LS-DYNA, see the remarks section of *MAT_002 / *MAT_OPTIONTROPIC_ELASTIC.

*MAT_TEMPERATURE_DEPENDENT_ORTHOTROPIC

This is Material Type 23. It models an orthotropic elastic material with arbitrary temperature dependency. It is available for solids, shells, and thick shells.

Card Summary:

Card 1. This card is required.

MID	RO	AOPT	REF	MACF	IHYPO		
-----	----	------	-----	------	-------	--	--

Card 2. This card is required.

XP	YP	ZP	A1	A2	A3		
----	----	----	----	----	----	--	--

Card 3. This card is required.

V1	V2	V3	D1	D2	D3	BETA	
----	----	----	----	----	----	------	--

Card 4.1. Define one set of constants on two cards using Cards 4.1 and 4.2 for each temperature point. Up to 48 points (96 cards) can be defined. The next keyword ("*") card terminates the input.

EA _i	EB _i	EC _i	PRBA _i	PRCA _i	PRCB _i		
-----------------	-----------------	-----------------	-------------------	-------------------	-------------------	--	--

Card 4.2. Define one set of constants on two cards using Cards 4.1 and 4.2 for each temperature point. Up to 48 points (96 cards) can be defined. The next keyword ("*") card terminates the input.

AA _i	AB _i	AC _i	GAB _i	GBC _i	GCA _i	T _i	
-----------------	-----------------	-----------------	------------------	------------------	------------------	----------------	--

Data Card Definitions:

Card 1	1	2	3	4	5	6	7	8
Variable	MID	RO	AOPT	REF	MACF	IHYPO		
Type	A	F	F	F	I	F		

VARIABLE

DESCRIPTION

MID

Material identification. A unique number or label must be specified (see *PART).

VARIABLE	DESCRIPTION
RO	Mass density
AOPT	<p>Material axes option (see MAT_OPTIONTROPIC_ELASTIC, particularly the Material Directions section, for details):</p> <p>EQ.0.0: Locally orthotropic with material axes determined by element nodes 1, 2, and 4, as with *DEFINE_COORDINATE_NODES. For shells only, the material axes are then rotated about the normal vector to the surface of the shell by the angle BETA.</p> <p>EQ.1.0: Locally orthotropic with material axes determined by a point, P, in space and the global location of the element center; this is the \mathbf{a}-direction. This option is for solid elements only.</p> <p>EQ.2.0: Globally orthotropic with material axes determined by vectors defined below, as with *DEFINE_COORDINATE_VECTOR</p> <p>EQ.3.0: Locally orthotropic material axes determined by a vector \mathbf{v} and the normal vector to the plane of the element. The plane of a solid element is the midsurface between the inner surface and outer surface defined by the first four nodes and the last four nodes of the connectivity of the element, respectively. Thus, for solid elements, AOPT = 3 is only available for hexahedrons. \mathbf{a} is determined by taking the cross product of \mathbf{v} with the normal vector, \mathbf{b} is determined by taking the cross product of the normal vector with \mathbf{a}, and \mathbf{c} is the normal vector. Then \mathbf{a} and \mathbf{b} are rotated about \mathbf{c} by an angle BETA. BETA may be set in the keyword input for the element or in the input for this keyword. Note that for solids, the material axes may be switched depending on the choice of MACF. The switch may occur before or after applying BETA depending on the value of MACF.</p> <p>EQ.4.0: Locally orthotropic in a cylindrical coordinate system with the material axes determined by a vector \mathbf{v}, and an originating point, P, which define the centerline axis. This option is for solid elements only.</p> <p>LT.0.0: The absolute value of AOPT is a coordinate system ID number (CID on *DEFINE_COORDINATE_OPTION).</p>

VARIABLE	DESCRIPTION
----------	-------------

REF	<p>Use reference geometry to initialize the stress tensor. The reference geometry is defined by the keyword: *INITIAL_FOAM_REFERENCE_GEOMETRY (see description of this keyword for more details).</p> <p>EQ.0.0: Off</p> <p>EQ.1.0: On</p>
-----	--

MACF	<p>Material axes change flag for solid elements:</p> <p>EQ.-4: Switch material axes <i>b</i> and <i>c</i> before BETA rotation</p> <p>EQ.-3: Switch material axes <i>a</i> and <i>c</i> before BETA rotation</p> <p>EQ.-2: Switch material axes <i>a</i> and <i>b</i> before BETA rotation</p> <p>EQ.1: No change, default</p> <p>EQ.2: Switch material axes <i>a</i> and <i>b</i> after BETA rotation</p> <p>EQ.3: Switch material axes <i>a</i> and <i>c</i> after BETA rotation</p> <p>EQ.4: Switch material axes <i>b</i> and <i>c</i> after BETA rotation</p>
------	--

Figure M2-2 indicates when LS-DYNA applies MACF during the process to obtain the final material axes. If BETA on *ELEMENT_SOLID_{OPTION} is defined, then that BETA is used for the rotation for all AOPT options. Otherwise, if AOPT = 3, the BETA input on Card 3 rotates the axes. For all other values of AOPT, the material axes will be switched as specified by MACF, but no BETA rotation will be performed.

IHYP0	<p>Option to switch between two different elastic approaches (only available for solid elements):</p> <p>EQ.0.0: Hyperelastic formulation, default</p> <p>EQ.1.0: Hypoelastic formulation (allows stress initialization through *INITIAL_STRESS_SOLID)</p>
-------	--

Card 2	1	2	3	4	5	6	7	8
Variable	XP	YP	ZP	A1	A2	A3		
Type	F	F	F	F	F	F		

VARIABLE**DESCRIPTION**

XP, YP, ZP

Coordinates of point p for AOPT = 1 and 4

A1, A2, A3

Components of vector \mathbf{a} for AOPT = 2

Card 3	1	2	3	4	5	6	7	8
Variable	V1	V2	V3	D1	D2	D3	BETA	
Type	F	F	F	F	F	F	F	

VARIABLE**DESCRIPTION**

V1, V2, V3

Components of vector \mathbf{v} for AOPT = 3 and 4

D1, D2, D3

Components of vector \mathbf{d} for AOPT = 2

BETA

Material angle in degrees for AOPT = 0 (shells and tshells only) and AOPT = 3. It may be overridden on the element card; see *ELEMENT_SHELL_BETA, *ELEMENT_TSHELL_BETA, or *ELEMENT_SOLID_ORTHO.

First Temperature Card. Define one set of constants on two cards using Cards 4.1 and 4.2 for each temperature point. Up to 48 points (96 cards) can be defined. The next keyword ("*") card terminates the input.

Card 4.1	1	2	3	4	5	6	7	8
Variable	EA i	EB i	EC i	PRBA i	PRCA i	PRCB i		
Type	F	F	F	F	F	F		

Second Temperature Card

Card 4.2	1	2	3	4	5	6	7	8
Variable	AA i	AB i	AC i	GAB i	GBC i	GCA i	T i	
Type	F	F	F	F	F	F	F	

VARIABLE	DESCRIPTION
E <i>Ai</i>	$E_{a,i}$, Young's modulus in a -direction at temperature T_i
E <i>Bi</i>	$E_{b,i}$, Young's modulus in b -direction at temperature T_i
E <i>Ci</i>	$E_{c,i}$, Young's modulus in c -direction at temperature T_i
PR <i>BAi</i>	$\nu_{ba,i}$, Poisson's ratio ba at temperature T_i
PR <i>CAi</i>	$\nu_{ca,i}$, Poisson's ratio ca at temperature T_i
PR <i>CBi</i>	$\nu_{cb,i}$, Poisson's ratio cb at temperature T_i
AA <i>i</i>	$\alpha_{a,i}$, coefficient of thermal expansion in a -direction at temperature T_i
AB <i>i</i>	$\alpha_{B,i}$, coefficient of thermal expansion in b -direction at temperature T_i .
AC <i>i</i>	$\alpha_{c,i}$, coefficient of thermal expansion in c -direction at temperature T_i .
GAB <i>i</i>	$G_{ab,i}$, Shear modulus ab at temperature T_i .
GBC <i>i</i>	$G_{bc,i}$, Shear modulus bc at temperature T_i .
GCA <i>i</i>	$G_{ca,i}$, Shear modulus ca at temperature T_i .
T_i	i^{th} temperature

Remarks:

In the implementation for three-dimensional continua a total Lagrangian formulation is used. In this approach the material law that relates second Piola-Kirchhoff stress \mathbf{S} to the Green-St. Venant strain \mathbf{E} is

$$\mathbf{S} = \mathbf{C} : \mathbf{E} = \mathbf{T}^T \mathbf{C}_i \mathbf{T} : \mathbf{E}$$

where \mathbf{T} is the transformation matrix [Cook 1974].

$$\mathbf{T} = \begin{bmatrix} l_1^2 & m_1^2 & n_1^2 & l_1 m_1 & m_1 n_1 & n_1 l_1 \\ l_2^2 & m_2^2 & n_2^2 & l_2 m_2 & m_2 n_2 & n_2 l_2 \\ l_3^2 & m_3^2 & n_3^2 & l_3 m_3 & m_3 n_3 & n_3 l_3 \\ 2l_1 l_2 & 2m_1 m_2 & 2n_1 n_2 & (l_1 m_2 + l_2 m_1) & (m_1 n_2 + m_2 n_1) & (n_1 l_2 + n_2 l_1) \\ 2l_2 l_3 & 2m_2 m_3 & 2n_2 n_3 & (l_2 m_3 + l_3 m_2) & (m_2 n_3 + m_3 n_2) & (n_2 l_3 + n_3 l_2) \\ 2l_3 l_1 & 2m_3 m_1 & 2n_3 n_1 & (l_3 m_1 + l_1 m_3) & (m_3 n_1 + m_1 n_3) & (n_3 l_1 + n_1 l_3) \end{bmatrix}$$

l_i, m_i, n_i are the direction cosines

$$x'_i = l_i x_1 + m_i x_2 + n_i x_3 \text{ for } i = 1, 2, 3$$

and x'_i denotes the material axes. The temperature dependent constitutive matrix C_l is defined in terms of the material axes as

$$C_l^{-1} = \begin{bmatrix} \frac{1}{E_{11}(T)} & -\frac{\nu_{21}(T)}{E_{22}(T)} & -\frac{\nu_{31}(T)}{E_{33}(T)} & 0 & 0 & 0 \\ \frac{\nu_{12}(T)}{E_{11}(T)} & \frac{1}{E_{22}(T)} & -\frac{\nu_{32}(T)}{E_{33}(T)} & 0 & 0 & 0 \\ -\frac{\nu_{13}(T)}{E_{11}(T)} & -\frac{\nu_{23}(T)}{E_{22}(T)} & \frac{1}{E_{33}(T)} & 0 & 0 & 0 \\ 0 & 0 & 0 & \frac{1}{G_{12}(T)} & 0 & 0 \\ 0 & 0 & 0 & 0 & \frac{1}{G_{23}(T)} & 0 \\ 0 & 0 & 0 & 0 & 0 & \frac{1}{G_{31}(T)} \end{bmatrix}$$

where the subscripts denote the material axes,

$$\nu_{ij} = \nu_{x'_i x'_j} \quad \text{and} \quad E_{ii} = E_{x'_i}$$

Since C_l is symmetric

$$\frac{\nu_{12}}{E_{11}} = \frac{\nu_{21}}{E_{22}}, \dots$$

The vector of Green-St. Venant strain components is

$$\mathbf{E}^T = [E_{11}, E_{22}, E_{33}, E_{12}, E_{23}, E_{31}]$$

which include the local thermal strains which are integrated in time:

$$\varepsilon_{aa}^{n+1} = \varepsilon_{aa}^n + \alpha_a \left(T^{n+\frac{1}{2}} \right) [T^{n+1} - T^n]$$

$$\varepsilon_{bb}^{n+1} = \varepsilon_{bb}^n + \alpha_b \left(T^{n+\frac{1}{2}} \right) [T^{n+1} - T^n]$$

$$\varepsilon_{cc}^{n+1} = \varepsilon_{cc}^n + \alpha_c \left(T^{n+\frac{1}{2}} \right) [T^{n+1} - T^n]$$

where T is temperature. After computing S_{ij} we then obtain the Cauchy stress:

$$\sigma_{ij} = \frac{\rho}{\rho_0} \frac{\partial x_i}{\partial X_k} \frac{\partial x_j}{\partial X_l} S_{kl}$$

This model will predict realistic behavior for finite displacement and rotations as long as the strains are small.

For shell elements, the stresses are integrated in time and are updated in the corotational coordinate system. In this procedure the local material axes are assumed to remain orthogonal in the deformed configuration. This assumption is valid if the strains remain small.

***MAT_PIECEWISE_LINEAR_PLASTICITY_{OPTION}**

Available options include:

<BLANK>

LOG_INTERPOLATION

STOCHASTIC

MIDFAIL

2D

This is Material Type 24. It is an elasto-plastic material with an arbitrary stress as a function of strain curve that can also have an arbitrary strain rate dependency (see Remarks below). Failure based on a plastic strain or a minimum time step size can be defined. For another model with a more comprehensive failure criteria see *MAT_MODIFIED_PIECEWISE_LINEAR_PLASTICITY. If considering laminated or sandwich shells with non-uniform material properties (this is defined through the user specified integration rule), the model, *MAT_LAYERED_LINEAR_PLASTICITY, is recommended. If solid elements are used and if the elastic strains before yielding are finite, the model, *MAT_FINITE_ELASTIC_STRAIN_PLASTICITY, treats the elastic strains using a hyperelastic formulation.

The LOG_INTERPOLATION keyword option interpolates the strain rates in a table LCSS with logarithmic interpolation.

The STOCHASTIC keyword option allows spatially varying yield and failure behavior. See *DEFINE_STOCHASTIC_VARIATION for additional information.

The MIDFAIL keyword option is available for thin shell elements and thick shell formulations which use thin shell material models. When included on the keyword line, this option causes failure to be checked only at the mid-plane of the element. If an element has an even number of layers, failure is checked in the two layers closest to the mid-plane.

The 2D keyword option is available only for shell elements. It invokes actual plane stress treatment, meaning transverse shear stresses are not part of the yield condition but updated elastically.

MAT_024**MAT_PIECEWISE_LINEAR_PLASTICITY**

Card 1	1	2	3	4	5	6	7	8
Variable	MID	RO	E	PR	SIGY	ETAN	FAIL	TDEL
Type	A	F	F	F	F	F	F	F
Default	none	none	none	none	none	0.0	10 ²¹	0.0

Card 2	1	2	3	4	5	6	7	8
Variable	C	P	LCSS	LCSR	VP			
Type	F	F	I	I	F			
Default	0.0	0.0	0	0	0.0			

Card 3	1	2	3	4	5	6	7	8
Variable	EPS1	EPS2	EPS3	EPS4	EPS5	EPS6	EPS7	EPS8
Type	F	F	F	F	F	F	F	F
Default	0.0	0.0	0.0	0.0	0.0	0.0	0.0	0.0

Card 4	1	2	3	4	5	6	7	8
Variable	ES1	ES2	ES3	ES4	ES5	ES6	ES7	ES8
Type	F	F	F	F	F	F	F	F
Default	0.0	0.0	0.0	0.0	0.0	0.0	0.0	0.0

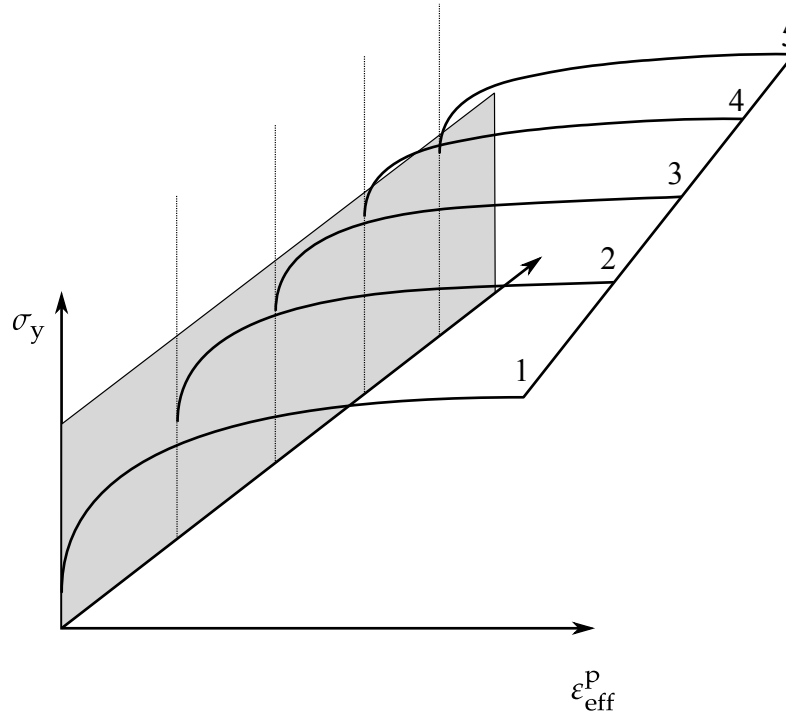

Figure M24-1. Rate effects may be accounted for by defining a table of curves. If a table ID is specified, a curve ID is given for each strain rate; see *DEFINE_TABLE. Intermediate values are found by interpolating between curves. Effective plastic strain as a function of yield stress is expected. If the strain rate values fall out of range, extrapolation is not used; rather, either the first or last curve determines the yield stress depending on whether the rate is low or high, respectively.

VARIABLE	DESCRIPTION
MID	Material identification. A unique number or label must be specified (see *PART).
RO	Mass density
E	Young's modulus
PR	Poisson's ratio
SIGY	Yield stress; ignored if LCSS > 0 except as described in Remark 1a .
ETAN	Tangent modulus; ignored if LCSS > 0 is defined.
FAIL	Failure flag: LT.0.0: User defined failure subroutine, matusr_24 in dyn21.F, is called to determine failure.

VARIABLE	DESCRIPTION
	<p>EQ.0.0: Failure is not considered. This option is recommended if failure is not of interest since many calculations will be saved.</p>
	<p>GT.0.0: Effective plastic strain to failure. When the plastic strain reaches this value, the element is deleted from the calculation.</p>
TDEL	Minimum time step size for automatic element deletion
C	Strain rate parameter, <i>C</i> ; see Remarks 1 and 3 .
P	Strain rate parameter, <i>p</i> ; see Remark 1 .
LCSS	<p>Load curve ID or Table ID</p> <p>Load Curve. When LCSS is a load curve ID, it is taken as defining effective stress as a function of effective plastic strain. If defined, EPS1 - EPS8 and ES1 - ES8 are ignored. See Remark 7 for load curve discretization behavior.</p> <p>Tabular Data. The table ID defines for each strain rate value a load curve ID giving the stress as a function effective plastic strain for that rate; see Figure M24-1. When the strain rate falls below the minimum value, the stress as a function of effective plastic strain curve for the lowest value of strain rate is used. Likewise, when the strain rate exceeds the maximum value the stress as a function of effective plastic strain curve for the highest value of strain rate is used. <i>C</i>, <i>P</i>, <i>LCSR</i>, EPS1 - EPS8, and ES1 - ES8 are ignored if a table ID is defined. Linear interpolation between the discrete strain rates is used by default; logarithmic interpolation is used when the LOG_INTERPOLATION option is invoked.</p> <p>Logarithmically Defined Tables. Logarithmic interpolation between discrete strain rates is also assumed if the <i>first</i> value in the table is negative, in which case LS-DYNA assumes that all the table values represent the natural logarithm of a strain rate. Since the tables are internally discretized to equally space the table values, it makes good sense from an accuracy standpoint that the table values represent the natural log of strain rate when the lowest strain rate and highest strain rate differ by several orders of magnitude. Note that this option works only when the lowest strain rate has value less than 1.0. For values greater than or equal to 1.0, use the LOG_INTERPOLATION option. There is some additional computational cost associated with invoking logarithmic interpolation.</p>

VARIABLE	DESCRIPTION
	<p>Multi-Dimensional Tables. With $VP = 3$, yield stress can be a function of plastic strain, strain rate, and up to seven history variables (see Remark 4). That means LCSS can refer to *DEFINE_TABLE_XD or *DEFINE_TABLE_COMPACT up to a level of 9.</p>
LCSR	<p>Load curve ID defining strain rate scaling effect on yield stress. If LCSR is negative, the load curve is evaluated using a binary search for the correct interval for the strain rate. The binary search is slower than the default incremental search, but in cases where large changes in the strain rate may occur over a single time step, it is more robust. This option is not necessary for the viscoplastic formulation.</p>
VP	<p>Formulation for rate effects:</p> <p>EQ.-1.0: Cowper-Symonds with effective deviatoric strain rate rather than total</p> <p>EQ.0.0: Scale yield stress (default)</p> <p>EQ.1.0: Viscoplastic formulation</p> <p>EQ.3.0: Same as $VP = 0$, but with filtered effective total strain rates (see Remark 3)</p>
EPS1 - EPS8	<p>Effective plastic strain values (optional). If used, at least 2 points should be defined. The first point must be zero corresponding to the initial yield stress. WARNING: If the first point is nonzero, the yield stress is extrapolated to determine the initial yield. If this option is used, SIGY and ETAN are ignored and may be input as zero.</p>
ES1 - ES8	<p>Corresponding yield stress values to EPS1 - EPS8</p>

Remarks:

1. **Stress-Strain Behavior.** The stress-strain behavior may be treated by a bilinear stress strain curve by defining the tangent modulus, ETAN. Alternately, a curve of effective stress as a function of effective plastic strain similar to that shown in [Figure M10-1](#) may be defined by (EPS1, ES1) - (EPS8, ES8); however, a curve ID (LCSS) may be referenced instead if eight points are insufficient. The cost is roughly the same for either approach. Note that in the special case of uniaxial stress, true stress as a function of true plastic strain is equivalent to effective stress as a function effective plastic strain. The most general approach is to use the table definition (LCSS) discussed below.

Three options to account for strain rate effects are possible:

- a) Strain rate may be accounted for using the Cowper and Symonds model which scales the yield stress with the factor

$$1 + \left(\frac{\dot{\epsilon}}{C}\right)^{1/p},$$

where $\dot{\epsilon}$ is the strain rate. $\dot{\epsilon} = \sqrt{\dot{\epsilon}_{ij}\dot{\epsilon}_{ij}}$. If VP = -1, the deviatoric strain rates are used instead.

If the viscoplastic option is active (VP = 1.0) and if SIGY is > 0 then the dynamic yield stress is computed from the sum of the static stress, $\sigma_y^s(\epsilon_{\text{eff}}^p)$, which is typically given by a load curve ID and the initial yield stress, SIGY, multiplied by the Cowper-Symonds rate term as follows:

$$\sigma_y(\epsilon_{\text{eff}}^p, \dot{\epsilon}_{\text{eff}}^p) = \sigma_y^s(\epsilon_{\text{eff}}^p) + \text{SIGY} \times \left(\frac{\dot{\epsilon}_{\text{eff}}^p}{C}\right)^{1/p}.$$

Here the plastic strain rate is used. With this latter approach similar results to *MAT_ANISOTROPIC_VISCOPLASTIC can be obtained. If SIGY = 0, the following equation is used instead where the static stress, $\sigma_y^s(\epsilon_{\text{eff}}^p)$, must be defined by a load curve:

$$\sigma_y(\epsilon_{\text{eff}}^p, \dot{\epsilon}_{\text{eff}}^p) = \sigma_y^s(\epsilon_{\text{eff}}^p) \left[1 + \left(\frac{\dot{\epsilon}_{\text{eff}}^p}{C}\right)^{1/p} \right].$$

This latter equation is always used if the viscoplastic option is off.

- b) For complete generality a load curve (LCSR) to scale the yield stress may be input instead. In this curve the scale factor as a function of strain rate is defined.
- c) If different stress as a function of strain curves can be provided for various strain rates, the option using the reference to a table (LCSS) can be used. Then the table input in *DEFINE_TABLE must be used; see [Figure M24-1](#).
2. **Viscoplastic Formulation.** A fully viscoplastic formulation is optional (variable VP = 1) which incorporates the different options above within the yield surface. An additional cost is incurred over the simple scaling, but the improvement in results can be dramatic.
3. **Filtered Strain Rates.** With the option VP = 3 it is possible to use filtered strain rates. This means that the total strain rate is used as with VP = 0, but this can now be filtered with the help of field C (not Cowper-Symonds in this case) and the following exponential moving average equation:

$$\dot{\epsilon}_n^{avg} = C \times \dot{\epsilon}_{n-1}^{avg} + (1 - C) \times \dot{\epsilon}_n$$

This might be helpful if a table LCSS with crossing yield curves is used.

4. **Yield Stress Depending on History Variables.** When VP = 3, the yield stress defined with LCSS can depend on up to seven history variables through a multi-dimensional table. These seven history variables are history variables 6 through 12 which you will have to set using *INITIAL_HISTORY_NODE or *INITIAL_STRESS_SOLID/SHELL and whose meanings are, therefore, determined by you. For instance, you can set the values of history variables 6, 9, and 10 for certain nodes and have the value of yield stress depend upon history variables 6, 9, and 10. Note that these history variables are only initialized and do not evolve in time. See *DEFINE_TABLE_XD or *DEFINE_TABLE_COMPACT for more details.
5. **Implicit Calculations.** For implicit calculations with this material involving severe nonlinear hardening, the radial return method may result in inaccurate stress-strain response. Setting IACC = 1 on *CONTROL_ACCURACY activates a fully iterative plasticity algorithm, which will remedy this. This is not to be confused with the MITER flag on *CONTROL_SHELL which governs the treatment of the plane stress assumption for shell elements. If failure is applied with this option, incident failure will initiate damage, and the stress will continuously degrade to zero before erosion for a deformation of 1% plastic strain. So for instance, if the failure strain is FAIL = 0.05, then the element is eroded when $\bar{\epsilon}^p = 0.06$ and the material goes from intact to completely damaged between $\bar{\epsilon}^p = 0.05$ and $\bar{\epsilon}^p = 0.06$. The reason is to enhance implicit performance by maintaining continuity in the internal forces.
6. **Failure Output.** For a nonzero failure strain, *DEFINE_MATERIAL_HISTORIES can be used to output the failure indicator.

<i>*DEFINE_MATERIAL_HISTORIES Properties</i>		
Label	Attributes	Description
Instability	- - - -	Failure indicator $\epsilon_{eff}^p / \epsilon_{fail}^p$, see FAIL
Plastic Strain Rate	- - - -	Effective plastic strain rate $\dot{\epsilon}_{eff}^p$

7. **LCSS Rediscretization.** In the special case where LCSS is a *DEFINE_CURVE, LCSS is not rediscretized (see LCINT in *DEFINE_CURVE).

***MAT_GEOLOGIC_CAP_MODEL**

This is Material Type 25. This is an inviscid two-invariant geologic cap model. This material model can be used for geomechanical problems or for materials such as concrete; see references cited below.

Card 1	1	2	3	4	5	6	7	8
Variable	MID	RO	BULK	G	ALPHA	THETA	GAMMA	BETA
Type	A	F	F	F	F	F	F	F

Card 2	1	2	3	4	5	6	7	8
Variable	R	D	W	X0	C	N		
Type	F	F	F	F	F	F		

Card 3	1	2	3	4	5	6	7	8
Variable	PLOT	FTYPE	VEC	TOFF				
Type	F	F	F	F				

VARIABLE**DESCRIPTION**

MID	Material identification. A unique number or label must be specified (see *PART).
RO	Mass density
BULK	Initial bulk modulus, K
G	Initial shear modulus
ALPHA	Failure envelope parameter, α
THETA	Failure envelope linear coefficient, θ
GAMMA	Failure envelope exponential coefficient, γ

VARIABLE	DESCRIPTION
BETA	Failure envelope exponent, β
R	Cap, surface axis ratio
D	Hardening law exponent
W	Hardening law coefficient
X0	Hardening law exponent, X_0
C	Kinematic hardening coefficient, \bar{c}
N	Kinematic hardening parameter
PLOT	<p>Save the following variable for plotting in LS-PrePost, where it will be labeled as "effective plastic strain:"</p> <p>EQ.1: hardening parameter, κ</p> <p>EQ.2: cap -J1 axis intercept, $X(\kappa)$</p> <p>EQ.3: volumetric plastic strain ε_v^p</p> <p>EQ.4: first stress invariant, J_1</p> <p>EQ.5: second stress invariant, $\sqrt{J_2}$</p> <p>EQ.6: not used</p> <p>EQ.7: not used</p> <p>EQ.8: response mode number</p> <p>EQ.9: number of iterations</p>
FTYPE	<p>Formulation flag:</p> <p>EQ.1: soils (cap surface may contract)</p> <p>EQ.2: concrete and rock (cap doesn't contract)</p>
VEC	<p>Vectorization flag:</p> <p>EQ.0: vectorized (fixed number of iterations)</p> <p>EQ.1: fully iterative</p> <p>If the vectorized solution is chosen, the stresses might be slightly off the yield surface; however, on vector computers a much more efficient solution is achieved.</p>
TOFF	Tension Cut Off, TOFF < 0 (positive in compression).

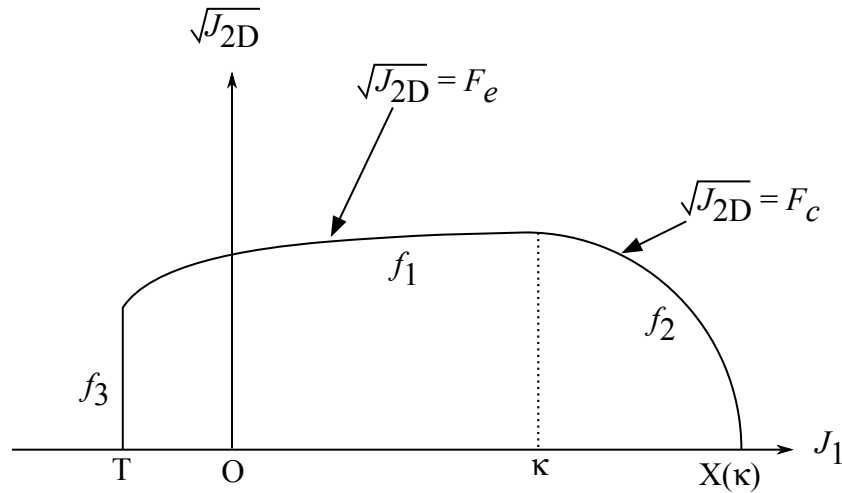

Figure M25-1. The yield surface of the two-invariant cap model in pressure $\sqrt{J_{2D}} - J_1$ space. Surface f_1 is the failure envelope, f_2 is the cap surface, and f_3 is the tension cutoff.

Remarks:

The implementation of an extended two-invariant cap model, suggested by Stojko [1990], is based on the formulations of Simo, et al. [1988, 1990] and Sandler and Rubin [1979]. In this model, the two-invariant cap theory is extended to include nonlinear kinematic hardening as suggested by Isenberg, Vaughan, and Sandler [1978]. A brief discussion of the extended cap model and its parameters is given below.

The cap model is formulated in terms of the invariants of the stress tensor. The square root of the second invariant of the deviatoric stress tensor, $\sqrt{J_{2D}}$ is found from the deviatoric stresses s as

$$\sqrt{J_{2D}} \equiv \sqrt{\frac{1}{2} S_{ij} S_{ij}}$$

and is the objective scalar measure of the distortional or shearing stress. The first invariant of the stress, J_1 , is the trace of the stress tensor.

The cap model consists of three surfaces in $\sqrt{J_{2D}} - J_1$ space, as shown in [Figure M25-1](#). First, there is a failure envelope surface, denoted f_1 in the figure. The functional form of f_1 is

$$f_1 = \sqrt{J_{2D}} - \min[F_e(J_1), T_{mises}],$$

where F_e is given by

$$F_e(J_1) \equiv \alpha - \gamma \exp(-\beta J_1) + \theta J_1$$

and $T_{mises} \equiv |X(\kappa_n) - L(\kappa_n)|$. This failure envelop surface is fixed in $\sqrt{J_{2D}} - J_1$ space, and therefore, does not harden unless kinematic hardening is present. Next, there is a cap surface, denoted f_2 in the figure, with f_2 given by

$$f_2 = \sqrt{J_{2D}} - F_c(J_1, K)$$

where F_c is defined by

$$F_c(J_1, \kappa) \equiv \frac{1}{R} \sqrt{[X(\kappa) - L(\kappa)]^2 - [J_1 - L(\kappa)]^2},$$

$X(\kappa)$ is the intersection of the cap surface with the J_1 axis

$$X(\kappa) = \kappa + RF_e(\kappa),$$

and $L(\kappa)$ is defined by

$$L(\kappa) \equiv \begin{cases} \kappa & \text{if } \kappa > 0 \\ 0 & \text{if } \kappa \leq 0 \end{cases}$$

The hardening parameter κ is related to the plastic volume change ε_v^p through the hardening law

$$\varepsilon_v^p = W\{1 - \exp[-D(X(\kappa) - X_0)]\}$$

Geometrically, κ is seen in the figure as the J_1 coordinate of the intersection of the cap surface and the failure surface. Finally, there is the tension cutoff surface, denoted f_3 in the figure. The function f_3 is given by

$$f_3 \equiv T - J_1$$

where T is the input material parameter which specifies the maximum hydrostatic tension sustainable by the material. The elastic domain in $\sqrt{J_{2D}} - J_1$ space is then bounded by the failure envelope surface above, the tension cutoff surface on the left, and the cap surface on the right.

An additive decomposition of the strain into elastic and plastic parts is assumed:

$$\varepsilon = \varepsilon^e + \varepsilon^p,$$

where ε^e is the elastic strain and ε^p is the plastic strain. Stress is found from the elastic strain using Hooke's law,

$$\sigma = \mathbf{C}(\varepsilon - \varepsilon^p),$$

where σ is the stress and \mathbf{C} is the elastic constitutive tensor.

The yield condition may be written

$$f_1(s) \leq 0$$

$$f_2(s, \kappa) \leq 0$$

$$f_3(s) \leq 0$$

and the plastic consistency condition requires that

$$\begin{aligned}\dot{\lambda}_k f_k &= 0 \\ k &= 1,2,3 \\ \dot{\lambda}_k &\geq 0\end{aligned}$$

where λ_k is the plastic consistency parameter for surface k . If $f_k < 0$ then, $\dot{\lambda}_k = 0$ and the response is elastic. If $f_k > 0$ then surface k is active and $\dot{\lambda}_k$ is found from the requirement that $\dot{f}_k = 0$.

Associated plastic flow is assumed, so using Koiter's flow rule, the plastic strain rate is given as the sum of contribution from all of the active surfaces,

$$\dot{\epsilon}^p = \sum_{k=1}^3 \dot{\lambda}_k \frac{\partial f_k}{\partial s} .$$

One of the major advantages of the cap model over other classical pressure-dependent plasticity models is the ability to control the amount of dilatancy produced under shear loading. Dilatancy is produced under shear loading as a result of the yield surface having a positive slope in $\sqrt{J_{2D}} - J$ space, so the assumption of plastic flow in the direction normal to the yield surface produces a plastic strain rate vector that has a component in the volumetric (hydrostatic) direction (see [Figure M25-1](#)). In models such as the Drucker-Prager and Mohr-Coulomb, this dilatancy continues as long as shear loads are applied, and in many cases produces far more dilatancy than is experimentally observed in material tests. In the cap model, when the failure surface is active, dilatancy is produced just as with the Drucker-Prager and Mohr-Coulomb models. However, the hardening law permits the cap surface to contract until the cap intersects the failure envelope at the stress point, and the cap remains at that point. The local normal to the yield surface is now vertical, and therefore the normality rule assures that no further plastic volumetric strain (dilatancy) is created. Adjustment of the parameters that control the rate of cap contractions permits experimentally observed amounts of dilatancy to be incorporated into the cap model, thus producing a constitutive law which better represents the physics to be modeled.

Another advantage of the cap model over other models such as the Drucker-Prager and Mohr-Coulomb is the ability to model plastic compaction. In these models all purely volumetric response is elastic. In the cap model, volumetric response is elastic until the stress point hits the cap surface. Therefore, plastic volumetric strain (compaction) is generated at a rate controlled by the hardening law. Thus, in addition to controlling the amount of dilatancy, the introduction of the cap surface adds another experimentally observed response characteristic of geological material into the model.

The inclusion of kinematic hardening results in hysteretic energy dissipation under cyclic loading conditions. Following the approach of Isenberg, et al. [1978] a nonlinear kinematic hardening law is used for the failure envelope surface when nonzero values of \bar{c} and N are specified. In this case, the failure envelope surface is replaced by a family of yield surfaces bounded by an initial yield surface and a limiting failure envelope surface.

Thus, the shape of the yield surfaces described above remains unchanged, but they may translate in a plane orthogonal to the J axis,

Translation of the yield surfaces is permitted through the introduction of a “back stress” tensor, α . The formulation including kinematic hardening is obtained by replacing the stress σ with the translated stress tensor $\eta \equiv \sigma - \alpha$ in all of the above equations. The history tensor α is assumed deviatoric and therefore has only 5 unique components. The evolution of the back stress tensor is governed by the nonlinear hardening law

$$\dot{\alpha} = \bar{c}\bar{F}(\sigma, \alpha)\dot{e}^p$$

where \bar{c} is a constant, \bar{F} is a scalar function of σ and α and \dot{e}^p is the rate of deviatoric plastic strain. The constant may be estimated from the slope of the shear stress - plastic shear strain curve at low levels of shear stress.

The function \bar{F} is defined as

$$\bar{F} \equiv \max \left[0, 1 - \frac{(\sigma - \alpha)\alpha}{2NF_e(J_1)} \right],$$

where N is a constant defining the size of the yield surface. The value of N may be interpreted as the radial distance between the outside of the initial yield surface and the inside of the limit surface. In order for the limit surface of the kinematic hardening cap model to correspond with the failure envelope surface of the standard cap model, the scalar parameter α must be replaced $\alpha - N$ in the definition F_e .

The cap model contains a number of parameters which must be chosen to represent a particular material and are generally based on experimental data. The parameters α , β , θ , and γ are usually evaluated by fitting a curve through failure data taken from a set of triaxial compression tests. The parameters W , D , and X_0 define the cap hardening law. The value W represents the void fraction of the uncompressed sample and D governs the slope of the initial loading curve in hydrostatic compression. The value of R is the ratio of major to minor axes of the quarter ellipse defining the cap surface. Additional details and guidelines for fitting the cap model to experimental data are found in Chen and Baladi [1985].

***MAT_HONEYCOMB**

This is Material Type 26. The major use of this material model is for honeycomb and foam materials with real anisotropic behavior. A nonlinear elastoplastic material behavior can be defined separately for all normal and shear stresses. These are considered to be fully uncoupled. See notes below. This material is available for solid elements and for thick shell formulations 3, 5, and 7.

Card 1	1	2	3	4	5	6	7	8
Variable	MID	RO	E	PR	SIGY	VF	MU	BULK
Type	A	F	F	F	F	F	F	F
Default	none	none	none	none	none	none	.05	0.0

Card 2	1	2	3	4	5	6	7	8
Variable	LCA	LCB	LCC	LCS	LCAB	LCBC	LCCA	LCSR
Type	F	F	F	F	F	F	F	F
Default	none	LCA	LCA	LCA	LCS	LCS	LCS	optional

Card 3	1	2	3	4	5	6	7	8
Variable	EAAU	EBBU	ECCU	GABU	GBCU	GCAU	AOPT	MACF
Type	F	F	F	F	F	F		I

Card 4	1	2	3	4	5	6	7	8
Variable	XP	YP	ZP	A1	A2	A3		
Type	F	F	F	F	F	F		

Card 5	1	2	3	4	5	6	7	8
Variable	D1	D2	D3	TSEF	SSEF	V1	V2	V3
Type	F	F	F	F	F	F	F	F

VARIABLE**DESCRIPTION**

MID	Material identification. A unique number or label must be specified (see *PART).
RO	Mass density.
E	Young's modulus for compacted honeycomb material.
PR	Poisson's ratio for compacted honeycomb material.
SIGY	Yield stress for fully compacted honeycomb.
VF	Relative volume at which the honeycomb is fully compacted.
MU	μ , material viscosity coefficient. The default, 0.05, is recommended.
BULK	Bulk viscosity flag: EQ.0.0: Bulk viscosity is not used. This is recommended. EQ.1.0: Bulk viscosity is active and $\mu = 0$. This will give results identical to previous versions of LS-DYNA.
LCA	Load curve ID (see *DEFINE_CURVE) for σ_{aa} as a function of either relative volume or volumetric strain. See Remarks 1 and 3 .
LCB	Load curve ID (see *DEFINE_CURVE) for σ_{bb} as a function of either relative volume or volumetric strain. By default, LCB = LCA. See Remarks 1 and 3 .
LCC	Load curve ID (see *DEFINE_CURVE) for σ_{cc} as a function of either relative volume or volumetric strain. By default, LCC = LCA. See Remarks 1 and 3 .
LCS	Load curve ID (see *DEFINE_CURVE) for shear stress as a function of either relative volume or volumetric strain. By default, LCS = LCA. Each component of shear stress may have its own load curve. See Remarks 1 and 3 .

VARIABLE	DESCRIPTION
LCAB	Load curve ID (see *DEFINE_CURVE) for σ_{ab} as a function of either relative volume or volumetric strain. By default, LCAB = LCS. See Remarks 1 and 3 .
LCBC	Load curve ID (see *DEFINE_CURVE) for σ_{bc} as a function of either relative volume or volumetric strain. By default, LCBC = LCS. See Remarks 1 and 3 .
LCCA	Load curve ID (see *DEFINE_CURVE) for σ_{ca} as a function of either relative volume or volumetric strain. Default LCCA = LCS. See Remarks 1 and 3 .
LCSR	Load curve ID (see *DEFINE_CURVE) for strain-rate effects defining the scale factor as a function of strain rate. This is optional. The curves defined above are scaled using this curve. See Remark 3 .
EAAU	Elastic modulus E_{aaU} in uncompressed configuration.
EBBU	Elastic modulus E_{bbU} in uncompressed configuration.
ECCU	Elastic modulus E_{ccU} in uncompressed configuration.
GABU	Shear modulus G_{abU} in uncompressed configuration.
GBCU	Shear modulus G_{bcU} in uncompressed configuration.
GCAU	Shear modulus G_{caU} in uncompressed configuration.
AOPT	Material axes option (see MAT_OPTIONTROPIC_ELASTIC, particularly the Material Directions section, for details): <p>EQ.0.0: Locally orthotropic with material axes determined by element nodes 1, 2, and 4, as with *DEFINE_COORDINATE_NODES. For shells only, the material axes are then rotated about the normal vector to the surface of the shell by the angle BETA.</p> <p>EQ.1.0: Locally orthotropic with material axes determined by a point, P, in space and the global location of the element center; this is the a-direction. This option is for solid elements only.</p> <p>EQ.2.0: Globally orthotropic with material axes determined by vectors defined below, as with *DEFINE_COORDINATE_VECTOR</p>

VARIABLE	DESCRIPTION
EQ.3.0:	Locally orthotropic material axes determined by a vector \mathbf{v} and the normal vector to the plane of the element. The plane of a solid element is the midsurface between the inner surface and outer surface defined by the first four nodes and the last four nodes of the connectivity of the element, respectively. Thus, for solid elements, AOPT = 3 is only available for hexahedrons. \mathbf{a} is determined by taking the cross product of \mathbf{v} with the normal vector, \mathbf{b} is determined by taking the cross product of the normal vector with \mathbf{a} , and \mathbf{c} is the normal vector. Then \mathbf{a} and \mathbf{b} are rotated about \mathbf{c} by an angle BETA. BETA may be set in the keyword input for the element. Note that for solids, the material axes may be switched depending on the choice of MACF. The switch may occur before or after applying BETA depending on the value of MACF.
EQ.4.0:	Locally orthotropic in a cylindrical coordinate system with the material axes determined by a vector \mathbf{v} , and an originating point, P , which define the centerline axis. This option is for solid elements only.
LT.0.0:	The absolute value of AOPT is a coordinate system ID number (CID on *DEFINE_COORDINATE_OPTION).
MACF	Material axes change flag for solid elements: EQ.-4: Switch material axes b and c before BETA rotation EQ.-3: Switch material axes a and c before BETA rotation EQ.-2: Switch material axes a and b before BETA rotation EQ.1: No change, default EQ.2: Switch material axes a and b after BETA rotation EQ.3: Switch material axes a and c after BETA rotation EQ.4: Switch material axes b and c after BETA rotation
	Figure M2-2 indicates when LS-DYNA applies MACF during the process to obtain the final material axes. BETA, if needed, is specified on *ELEMENT_SOLID_{OPTION}.
XP YP ZP	Coordinates of point p for AOPT = 1 and 4.
A1 A2 A3	Components of vector \mathbf{a} for AOPT = 2.

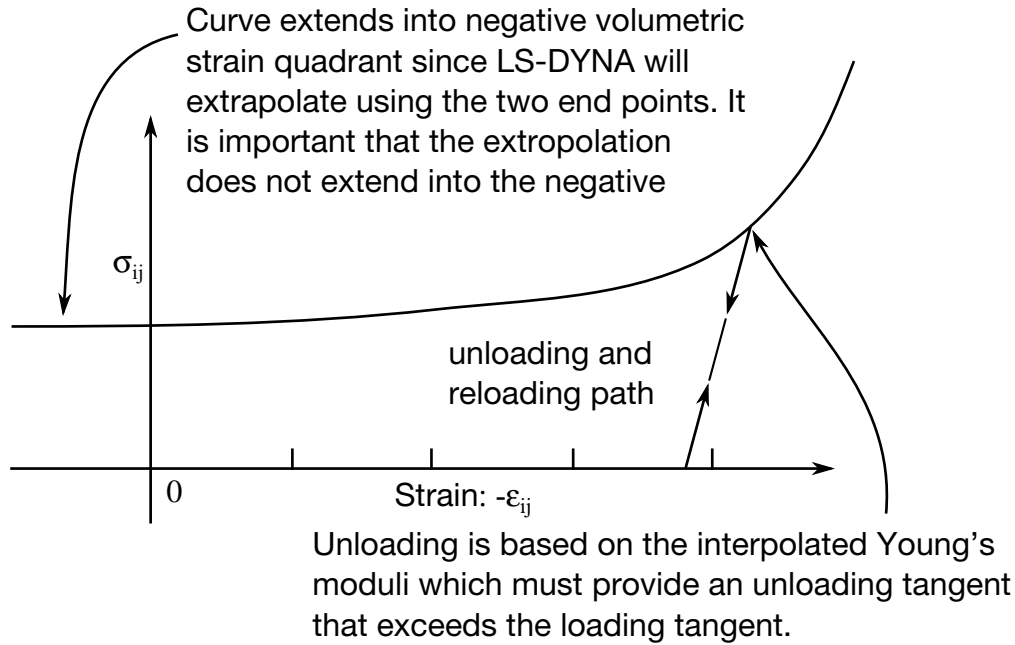

Figure M26-1. Stress quantity versus volumetric strain. Note that the “yield stress” at a volumetric strain of zero is non-zero. In the load curve definition, see *DEFINE_CURVE, the “time” value is the volumetric strain and the “function” value is the yield stress.

VARIABLE	DESCRIPTION
D1 D2 D3	Components of vector d for AOPT = 2.
V1 V2 V3	Define components of vector v for AOPT = 3 and 4.
TSEF	Tensile strain at element failure (element will erode).
SSEF	Shear strain at element failure (element will erode).

Remarks:

- Stress Load Curves.** For efficiency it is strongly recommended that the load curves with IDs LCA, LCB, LCC, LCS, LCAB, LCBC, and LCCA contain exactly the same number of points with corresponding strain values on the abscissa. If this recommendation is followed the cost of the table lookup is insignificant. Conversely, the cost increases significantly if the abscissa strain values are not consistent between load curves.

The load curves define the magnitude of the average stress as the material changes density (relative volume); see [Figure M26-1](#). There are two ways to define these curves, (1) as a function of relative volume, V , or (2) as a function of volumetric strain defined as:

$$\varepsilon_V = 1 - V .$$

In the former case, the first value in the curve should correspond to a value of relative volume slightly less than the fully compacted value. In the latter, the first value in the curve should be less than or equal to zero, corresponding to tension, and increase to full compaction. *Care should be taken when defining the curves so that extrapolated values do not lead to negative yield stresses.*

2. **Elastic/Shear Moduli during Compaction.** The behavior before compaction is orthotropic where the components of the stress tensor are uncoupled, meaning an a component of strain will generate resistance in the local a -direction with no coupling to the local b and c directions. The elastic moduli vary, from their initial values to the fully compacted values at V_f , linearly with the relative volume V :

$$E_{aa} = E_{aa0} + \beta(E - E_{aa0})$$

$$E_{bb} = E_{bb0} + \beta(E - E_{bb0})$$

$$E_{cc} = E_{cc0} + \beta(E - E_{cc0})$$

$$G_{ab} = G_{ab0} + \beta(G - G_{ab0})$$

$$G_{bc} = G_{bc0} + \beta(G - G_{bc0})$$

$$G_{ca} = G_{ca0} + \beta(G - G_{ca0})$$

where

$$\beta = \max \left[\min \left(\frac{1 - V}{1 - V_f}, 1 \right), 0 \right]$$

and G is the elastic shear modulus for the fully compacted honeycomb material

$$G = \frac{E}{2(1 + \nu)}.$$

The relative volume, V , is defined as the ratio of the current volume to the initial volume. Typically, $V = 1$ at the beginning of a calculation. The viscosity coefficient μ (MU) should be set to a small number (usually .02 - .10 is okay). Alternatively, the two bulk viscosity coefficients on the control cards should be set to very small numbers to prevent the development of spurious pressures that may lead to undesirable and confusing results. The latter is not recommended since spurious numerical noise may develop.

3. **Stress Updates.** At the beginning of the stress update each element's stresses and strain rates are transformed into the local element coordinate system. For the uncompact material, the trial stress components are updated using the elastic interpolated moduli (see [Remark 2](#)) according to:

$$\begin{aligned}
\sigma_{aa}^{n+1\text{trial}} &= \sigma_{aa}^n + E_{aa}\Delta\varepsilon_{aa} \\
\sigma_{bb}^{n+1\text{trial}} &= \sigma_{bb}^n + E_{bb}\Delta\varepsilon_{bb} \\
\sigma_{cc}^{n+1\text{trial}} &= \sigma_{cc}^n + E_{cc}\Delta\varepsilon_{cc} \\
\sigma_{ab}^{n+1\text{trial}} &= \sigma_{ab}^n + 2G_{ab}\Delta\varepsilon_{ab} \\
\sigma_{bc}^{n+1\text{trial}} &= \sigma_{bc}^n + 2G_{bc}\Delta\varepsilon_{bc} \\
\sigma_{ca}^{n+1\text{trial}} &= \sigma_{ca}^n + 2G_{ca}\Delta\varepsilon_{ca}
\end{aligned}$$

Each component of the updated stresses is then independently checked to ensure that they do not exceed the permissible values determined from the load curves; for example, if

$$|\sigma_{ij}^{n+1\text{trial}}| > \lambda\sigma_{ij}(V) ,$$

then

$$\sigma_{ij}^{n+1} = \sigma_{ij}(V) \frac{\lambda\sigma_{ij}^{n+1\text{trial}}}{|\lambda\sigma_{ij}^{n+1\text{trial}}|} .$$

The stress components are found using the curves defined on Card 2. The parameter λ is either unity or a value taken from the load curve number, LCSR, that defines λ as a function of strain-rate. Strain-rate is defined here as the Euclidean norm of the deviatoric strain-rate tensor.

For fully compacted material it is assumed that the material behavior is elastic-perfectly plastic and the stress components updated according to:

$$s_{ij}^{\text{trial}} = s_{ij}^n + 2G\Delta\varepsilon_{ij}^{\text{dev}n+1/2} ,$$

where the deviatoric strain increment is defined as

$$\Delta\varepsilon_{ij}^{\text{dev}} = \Delta\varepsilon_{ij} - \frac{1}{3}\Delta\varepsilon_{kk}\delta_{ij} .$$

Now a check is made to see if the yield stress for the fully compacted material is exceeded by comparing the effective trial stress,

$$s_{\text{eff}}^{\text{trial}} = \left(\frac{3}{2} s_{ij}^{\text{trial}} s_{ij}^{\text{trial}} \right)^{1/2} ,$$

to the defined yield stress, SIGY. If the effective trial stress exceeds the yield stress the stress components are simply scaled back to the yield surface

$$s_{ij}^{n+1} = \frac{\sigma_y}{s_{\text{eff}}^{\text{trial}}} s_{ij}^{\text{trial}} .$$

Now the pressure is updated using the elastic bulk modulus, K ,

$$p^{n+1} = p^n - K\Delta\varepsilon_{kk}^{n+1/2}$$

where

$$K = \frac{E}{3(1 - 2\nu)}$$

to obtain the final value for the Cauchy stress

$$\sigma_{ij}^{n+1} = s_{ij}^{n+1} - p^{n+1} \delta_{ij} .$$

After completing the stress the stresses are transformed back to the global configuration.

4. **Failure.** For *CONSTRAINED_TIED_NODES_WITH_FAILURE, the failure is based on the volume strain instead to the plastic strain.

***MAT_MOONEY-RIVLIN_RUBBER**

This is Material Type 27. A two-parametric material model for rubber can be defined.

Card 1	1	2	3	4	5	6	7	8
Variable	MID	RO	PR	A	B	REF		
Type	A	F	F	F	F	F		

Least Squares Card. If the values on Card 2 are nonzero, then a least squares fit is computed from the uniaxial data provided by the curve LCID. In this case A and B are ignored. If the A and B fields on Card 1 are left blank, then the fields on Card 2 *must* be nonzero.

Card 2	1	2	3	4	5	6	7	8
Variable	SGL	SW	ST	LCID				
Type	F	F	F	I				

VARIABLE

DESCRIPTION

MID	Material identification. A unique number or label must be specified (see *PART).
RO	Mass density
PR	Poisson’s ratio. A value between 0.49 and 0.5 is recommended; smaller values may not work.
A	Constant; see literature and remarks below. This field is ignored if the fields on Card 2 are nonzero.
B	Constant; see literature and remarks below. This field is ignored if the fields on Card 2 are nonzero.
REF	Use reference geometry to initialize the stress tensor. The reference geometry is defined by the keyword: *INITIAL_FOAM_REFERENCE_GEOMETRY. EQ.0.0: Off EQ.1.0: On

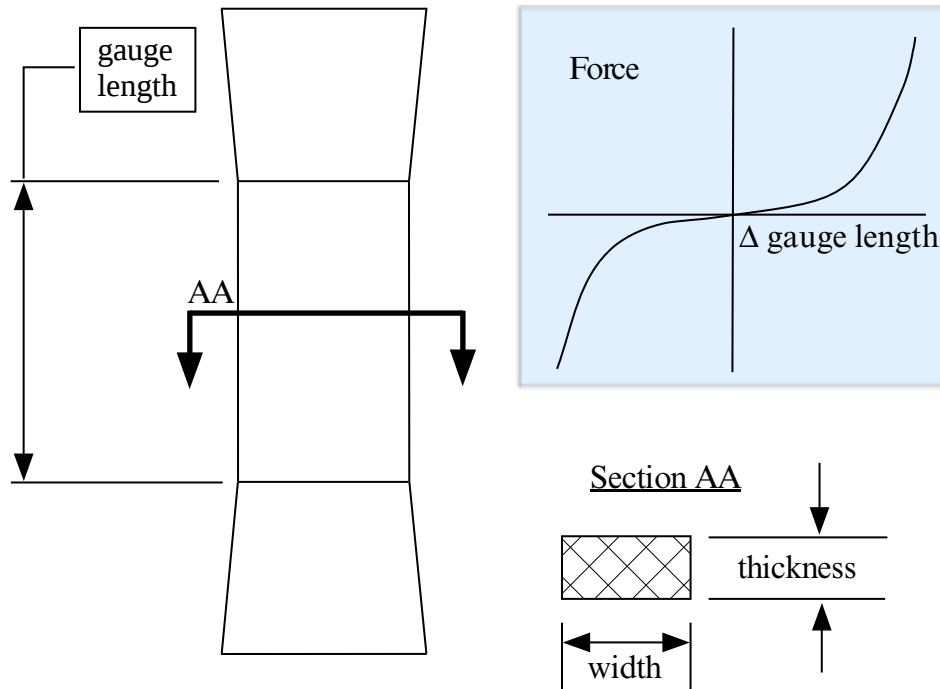

Figure M27-1. Uniaxial specimen for experimental data

VARIABLE	DESCRIPTION
SGL	Specimen gauge length l_0 ; see Figure M27-1 .
SW	Specimen width; see Figure M27-1 .
ST	Specimen thickness; see Figure M27-1 .
LCID	Curve ID, see *DEFINE_CURVE, giving the force versus actual change ΔL in the gauge length. See also Figure M27-2 for an alternative definition. A least squares fit is computed from this data. A and B are ignored if this field is defined.

Remarks:

The strain energy density function is defined as:

$$W = A(I - 3) + B(II - 3) + C(III^{-2} - 1) + D(III - 1)^2$$

where

$$C = 0.5A + B$$

$$D = \frac{A(5\nu - 2) + B(11\nu - 5)}{2(1 - 2\nu)}$$

ν = Poisson's ratio

$2(A + B)$ = shear modulus of linear elasticity

I, II, III = invariants of right Cauchy-Green Tensor C .

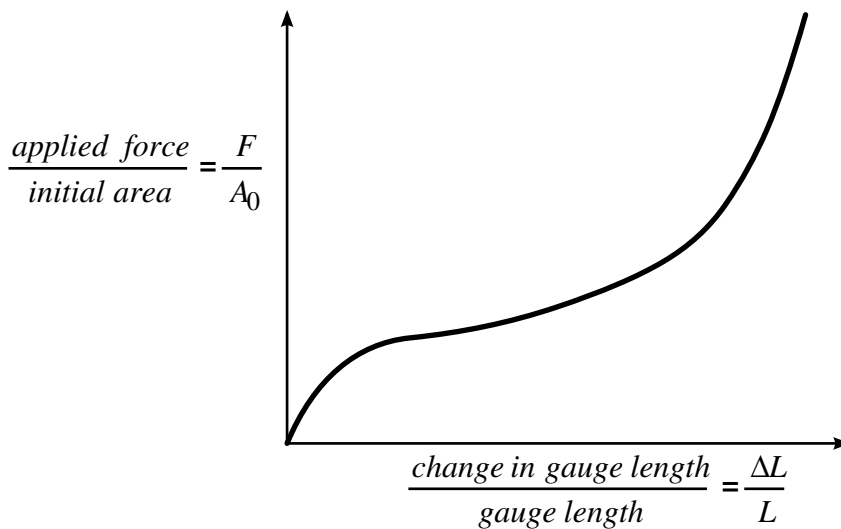

Figure M27-2 The stress as a function of strain curve can be used instead of the force as a function of the change in the gauge length by setting the gauge length, thickness, and width to unity (1.0) and defining the engineering strain in place of the change in gauge length and the nominal (engineering) stress in place of the force. *MAT_077_O is a better alternative for fitting data resembling the curve above. *MAT_027 will provide a poor fit to a curve that exhibits a strong upturn in slope as strains become large.

The load curve definition that provides the uniaxial data should give the change in gauge length, ΔL , versus the corresponding force. In compression both the force and the change in gauge length must be specified as negative values. In tension the force and change in gauge length should be input as positive values. The principal stretch ratio in the uniaxial direction, λ_1 , is then given by

$$\lambda_1 = \frac{L_0 + \Delta L}{L_0}$$

with L_0 being the initial length and L being the actual length.

Alternatively, the stress as a function of strain curve can also be input by setting the gauge length, thickness, and width to unity (1.0) and defining the engineering strain in place of the change in gauge length and the nominal (engineering) stress in place of the force; see [Figure M27-1](#).

The least square fit to the experimental data is performed during the initialization phase, and a comparison between the fit and the actual input is provided in the d3hsp file. It is a good idea to visually check to make sure it is acceptable. The coefficients A and B are also printed in the output file. It is also advised to use the material driver (see Appendix K) for checking out the material model.

The history variable labeled as “effective plastic strain” in LS-PrePost is internal energy density in the case of *MAT_MOONEY-RIVLIN_RUBBER.

***MAT_RESULTANT_PLASTICITY**

This is Material Type 28. It defines resultant formulation for beam and shell elements including elasto-plastic behavior. This model is available for the Belytschko-Schwer beam, the C⁰ triangular shell, the Belytschko-Tsay shell, and the fully integrated type 16 shell. For beams, the treatment is elastic-perfectly plastic, but for shell elements isotropic hardening is approximately modeled. For a detailed description we refer to the LS-DYNA Theory Manual. Since the stresses are not computed in the resultant formulation, the stresses output to the binary databases for the resultant elements are zero.

Card 1	1	2	3	4	5	6	7	8
Variable	MID	RO	E	PR	SIGY	ETAN		
Type	A	F	F	F	F	F		
Default	none	none	none	none	none	0.0		

VARIABLE**DESCRIPTION**

MID	Material identification. A unique number or label must be specified (see *PART).
RO	Mass density
E	Young's modulus
PR	Poisson's ratio
SIGY	Yield stress
ETAN	Plastic hardening modulus (for shells only)

***MAT_FORCE_LIMITED**

This is Material Type 29. It is a force limited resultant formulation. With this material model, for the Belytschko-Schwer beam only, plastic hinge forming at the ends of a beam can be modeled using curve definitions. Optionally, collapse can also be modeled. See also *MAT_139.

Card 1	1	2	3	4	5	6	7	8
Variable	MID	R0	E	PR	DF	IAFLC	YTFLAG	ASOFT
Type	A	F	F	F	F	I	F	F
Default	none	none	none	none	0.0	0	0.0	0.0

Card 2	1	2	3	4	5	6	7	8
Variable	M1	M2	M3	M4	M5	M6	M7	M8
Type	F	F	F	F	F	F	F	F
Default	none	0	0	0	0	0	0	0

Card 3	1	2	3	4	5	6	7	8
Variable	LC1	LC2	LC3	LC4	LC5	LC6	LC7	LC8
Type	F	F	F	F	F	F	F	F
Default	none	0	0	0	0	0	0	0

Card 4	1	2	3	4	5	6	7	8
Variable	LPS1	SFS1	LPS2	SFS2	YMS1	YMS2		
Type	F	F	F	F	F	F		
Default	0	1.0	LPS1	1.0	10 ²⁰	YMS1		

Card 5	1	2	3	4	5	6	7	8
Variable	LPT1	SFT1	LPT2	SFT2	YMT1	YMT2		
Type	F	F	F	F	F	F		
Default	0	1.0	LPT1	1.0	10 ²⁰	YMT1		

Card 6	1	2	3	4	5	6	7	8
Variable	LPR	SFR	YMR					
Type	F	F	F					
Default	0	1.0	10 ²⁰					

VARIABLE**DESCRIPTION**

MID	Material identification. A unique number or label must be specified (see *PART).
RO	Mass density
E	Young's modulus
PR	Poisson's ratio
DF	Damping factor; see Remark 2 . A proper control for the timestep must be maintained by the user.

VARIABLE	DESCRIPTION
IAFLC	Axial force load curve option: EQ.0: axial load curves are force as a function of strain. EQ.1: axial load curves are force as a function of change in length.
YTFLAG	Flag to allow beam to yield in tension: EQ.0.0: beam does not yield in tension. EQ.1.0: beam can yield in tension.
ASOFT	Axial elastic softening factor applied once hinge has formed. When a hinge has formed the stiffness is reduced by this factor. If zero, this factor is ignored.
M1, M2, ..., M8	Applied end moment for force as a function of (strain/change in length) curve. At least one must be defined. A maximum of 8 moments can be defined. The values should be in ascending order.
LC1, LC2, ..., LC8	Load curve ID (see *DEFINE_CURVE) defining axial force (collapse load) as a function of strain/change in length (see AOPT) for the corresponding applied end moment. Define the same number as end moments. Each curve must contain the same number of points.
LPS1	Load curve ID for plastic moment as a function of rotation about the <i>s</i> -axis at node 1. If zero, this load curve is ignored.
SFS1	Scale factor for plastic moment as a function of rotation curve about the <i>s</i> -axis at node 1. Default = 1.0.
LPS2	Load curve ID for plastic moment as a function of rotation about the <i>s</i> -axis at node 2. Default: LPS1.
SFS2	Scale factor for plastic moment as a function of rotation curve about the <i>s</i> -axis at node 2. Default: SFS1.
YMS1	Yield moment about the <i>s</i> -axis at node 1 for interaction calculations (default set to 10^{20} to prevent interaction).
YMS2	Yield moment about <i>s</i> -axis at node 2 for interaction calculations (default set to YMS1).
LPT1	Load curve ID for plastic moment as a function of rotation about the <i>t</i> -axis at node 1. If zero, this load curve is ignored.

VARIABLE	DESCRIPTION
SFT1	Scale factor for plastic moment as a function of rotation curve about the t -axis at node 1. Default = 1.0.
LPT2	Load curve ID for plastic moment as a function of rotation about the t -axis at node 2. Default: LPT1.
SFT2	Scale factor for plastic moment as a function of rotation curve about the t -axis at node 2. Default: SFT1.
YMT1	Yield moment about the t -axis at node 1 for interaction calculations (default set to 10^{20} to prevent interactions)
YMT2	Yield moment about the t -axis at node 2 for interaction calculations (default set to YMT1)
LPR	Load curve ID for plastic torsional moment as a function of rotation. If zero, this load curve is ignored.
SFR	Scale factor for plastic torsional moment as a function of rotation (default = 1.0).
YMR	Torsional yield moment for interaction calculations (default set to 10^{20} to prevent interaction)

Remarks:

1. **Load Curves.** This material model is available for the Belytschko resultant beam element only. Plastic hinges form at the ends of the beam when the moment reaches the plastic moment. The moment as a function rotation relationship is specified by the user in the form of a load curve and scale factor. The points of the load curve are (plastic rotation in radians, plastic moment). Both quantities should be positive for all points, with the first point being (0.0, initial plastic moment). Within this constraint any form of characteristic may be used, including flat or falling curves. Different load curves and scale factors may be specified at each node and about each of the local s and t axes.

Axial collapse occurs when the compressive axial load reaches the collapse load. Collapse load as a function of collapse deflection is specified in the form of a load curve. The points of the load curve are either (true strain, collapse force) or (change in length, collapse force). Both quantities should be entered as positive for all points and will be interpreted as compressive. The first point should be (0.0, initial collapse load).

The collapse load may vary with end moment as well as with deflections. In this case several load-deflection curves are defined, each corresponding to a different end moment. Each load curve should have the same number of points and the same deflection values. The end moment is defined as the average of the absolute moments at each end of the beam and is always positive.

2. **Damping.** Stiffness-proportional damping may be added using the damping factor λ . This is defined as follows:

$$\lambda = \frac{2 \times \zeta}{\omega}$$

where ζ is the damping factor at the reference frequency ω (in radians per second). For example if 1% damping at 2Hz is required

$$\lambda = \frac{2 \times 0.01}{2\pi \times 2} = 0.001592 .$$

If damping is used, a small timestep may be required. LS-DYNA does not check this, so to avoid instability it may be necessary to control the timestep using a load curve. As a guide, the timestep required for any given element is multiplied by $0.3L/c\lambda$ when damping is present (L = element length, c = sound speed).

3. **Moment Interaction.** Plastic hinges can form due to the combined action of moments about the three axes. This facility is activated only when yield moments are defined in the material input. A hinge forms when the following condition is first satisfied:

$$\left(\frac{M_r}{M_{r\text{yield}}} \right)^2 + \left(\frac{M_s}{M_{s\text{yield}}} \right)^2 + \left(\frac{M_t}{M_{t\text{yield}}} \right)^2 \geq 1 ,$$

where

$$M_r, M_s, M_t = \text{current moment}$$

$$M_{r\text{yield}}, M_{s\text{yield}}, M_{t\text{yield}} = \text{yield moment}$$

Note that scale factors for hinge behavior defined in the input will also be applied to the yield moments: for example, $M_{s\text{yield}}$ in the above formula is given by the input yield moment about the local axis times the input scale factor for the local s axis. For strain-softening characteristics, the yield moment should generally be set equal to the initial peak of the moment-rotation load curve.

On forming a hinge, upper limit moments are set. These are given by

$$M_{r\text{upper}} = \max \left(M_r, \frac{M_{r\text{yield}}}{2} \right)$$

and similar conditions hold for $M_{s\text{upper}}$ and $M_{t\text{upper}}$.

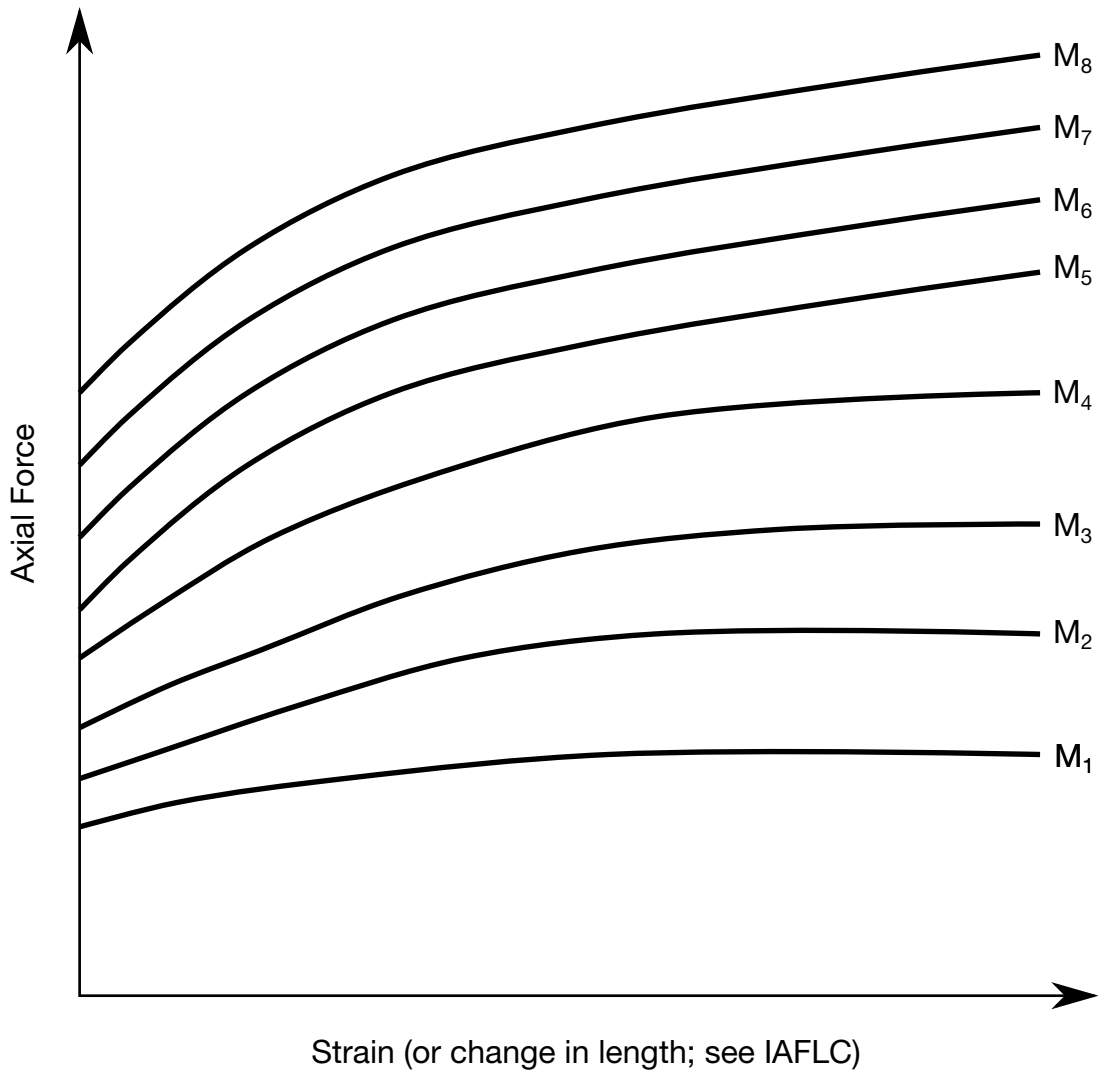

Figure M29-1. The force magnitude is limited by the applied end moment. For an intermediate value of the end moment LS-DYNA interpolates between the curves to determine the allowable force value.

Thereafter, the plastic moments will be given by

$$M_{r_p} = \min(M_{r_{upper}}, M_{r_{curve}})$$

where M_{r_p} is the current plastic moment and $M_{r_{curve}}$ is the moment from the load curve at the current rotation scaled by the scale factor. M_{s_p} and M_{t_p} satisfy similar conditions.

The effect of this is to provide an upper limit to the moment that can be generated; it represents the softening effect of local buckling at a hinge site. Thus if a member is bent about its local s -axis it will then be weaker in torsion and about its local t -axis. For moment-softening curves, the effect is to trim off the initial

peak (although if the curves subsequently harden, the final hardening will also be trimmed off).

It is not possible to make the plastic moment vary with axial load.

***MAT_SHAPE_MEMORY**

This is Material Type 30. This material model describes the superelastic response present in shape-memory alloys (SMA), that is, the peculiar material ability to undergo large deformations with a full recovery in loading-unloading cycles (see [Figure M30-1](#)). The material response is always characterized by a hysteresis loop. See the references by Auricchio, Taylor and Lubliner [1997] and Auricchio and Taylor [1997]. This model is available for shells, solids, and Hughes-Liu beam elements. The model supports von Mises isotropic plasticity with an arbitrary effective stress as a function of effective plastic strain curve.

Card 1	1	2	3	4	5	6	7	8
Variable	MID	RO	E	PR	LCSS			
Type	A	F	F	F	I			
Default	none	none	none	none	0			

Card 2	1	2	3	4	5	6	7	8
Variable	SIG_ASS	SIG_ASF	SIG_SAS	SIG_SAF	EPSL	ALPHA	YMRT	
Type	F	F	F	F	F	F	F	
Default	none	none	none	none	none	0.0	0.0	

Optional Load Curve Card (starting with R7.1). Load curves for mechanically induced phase transitions.

Card 3	1	2	3	4	5	6	7	8
Variable	LCID_AS	LCID_SA						
Type	I	I						
Default	none	none						

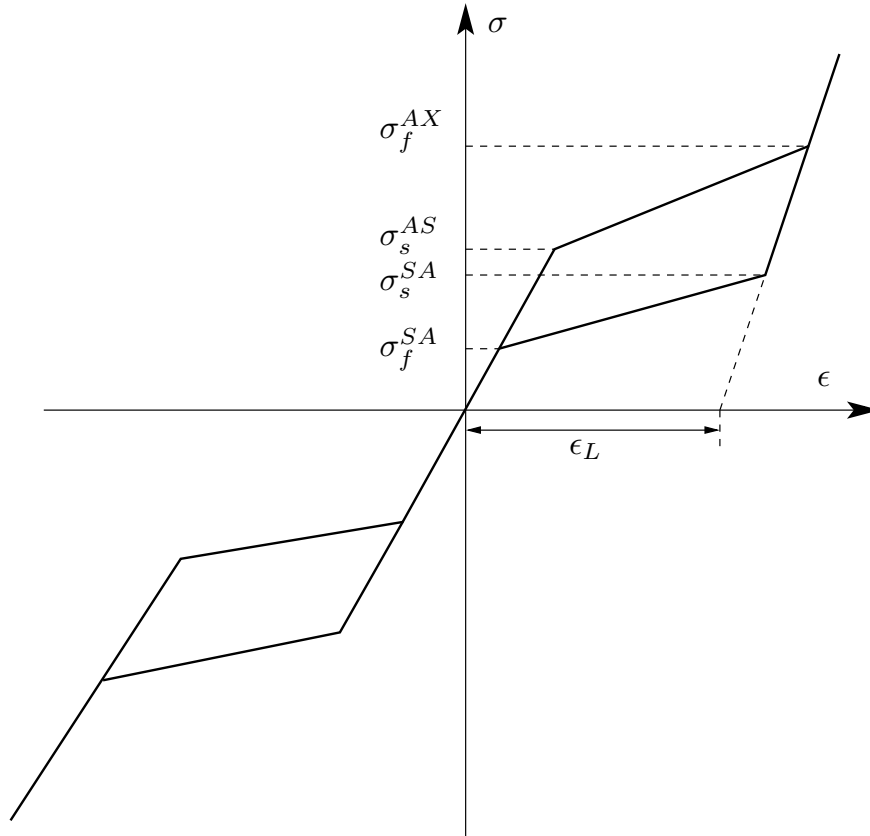

Figure M30-1. Superelastic Behavior for a Shape Memory Material

VARIABLE	DESCRIPTION
MID	Material identification. A unique number or label must be specified (see *PART).
RO	Mass density
E	Young's modulus
PR	Poisson's ratio
LCSS	The absolute value of LCSS is a load curve ID for effective stress as a function of effective plastic strain (this load curve is optional). The first data point, at zero plastic strain, indicates the initial yield stress. For a negative value of LCSS, negative values of SIG_ASS, SIG_ASF, SIG_SAS, SIG_SAF will indicate dependence on plastic strain; see below.

VARIABLE	DESCRIPTION
SIG_ASS	<p>Starting value for the forward phase transformation (conversion of austenite into martensite) in the case of a uniaxial tensile state of stress.</p> <p>LT.0.0: -SIG_ASS is a load curve ID defining the starting value as a function of temperature. If LCSS is also negative, then -SIG_ASS is either a load curve specifying the starting value as a function of effective plastic strain or a table of such load curves for different temperatures.</p>
SIG_ASF	<p>Final value for the forward phase transformation (conversion of austenite into martensite) in the case of a uniaxial tensile state of stress.</p> <p>LT.0.0: -SIG_ASF is a load curve ID defining the final value as a function of temperature is specified. If LCSS is also negative, -SIG_ASF is either a load curve specifying the final value as a function of effective plastic strain or a table of such load curves for different temperatures.</p>
SIG_SAS	<p>Starting value for the reverse phase transformation (conversion of martensite into austenite) in the case of a uniaxial tensile state of stress.</p> <p>LT.0.0: -SIG_SAS is a load curve ID defining the starting value as a function of temperature. If LCSS is also negative, -SIG_SAS is either a load curve specifying the starting value as a function of effective plastic strain or a table of such load curves for different temperatures.</p>
SIG_SAF	<p>Final value for the reverse phase transformation (conversion of martensite into austenite) in the case of a uniaxial tensile state of stress.</p> <p>LT.0.0: -SIG_SAF is a load curve ID specifying the reverse value as a function of temperature. If LCSS is also negative, -SIG_SAF is either a load curve specifying the final value as a function of effective plastic strain or a table of such load curves for different temperatures.</p>
EPSL	<p>Recoverable strain or maximum residual strain. It is a measure of the maximum deformation obtainable for all the martensite in one direction.</p>

VARIABLE	DESCRIPTION
ALPHA	Parameter measuring the difference between material responses in tension and compression (set alpha = 0 for no difference). Also, see the following remarks.
YMRT	Young's modulus for the martensite if it is different from the modulus for the austenite. Defaults to the austenite modulus if it is set to zero.
LCID_AS	<p data-bbox="490 560 1422 632">Load curve ID or table ID for the <i>forward</i> phase change (conversion of austenite into martensite).</p> <ol data-bbox="540 674 1422 972" style="list-style-type: none"> <li data-bbox="540 674 1422 785">1. When <i>LCID_AS</i> is a load curve ID the curve is taken to be effective stress as a function of martensite fraction (ranging from 0 to 1). <li data-bbox="540 827 1422 972">2. When <i>LCID_AS</i> is a table ID the table defines for each phase transition rate (derivative of martensite fraction) a load curve ID specifying the stress as a function of martensite fraction for that phase transition rate. The stress as a function of martensite fraction curve for the lowest value of the phase transition rate is used if the phase transition rate falls below the minimum value. Likewise, the stress as a function of martensite fraction curve for the highest value of phase transition rate is used if the phase transition rate exceeds the maximum value. <li data-bbox="540 1276 1422 1350">3. The values of SIG_ASS and SIG_ASF are overwritten when this option is used.
LCID_SA	<p data-bbox="490 1379 1422 1451">Load curve ID or table ID for <i>reverse</i> phase change (conversion of martensite into austenite).</p> <ol data-bbox="540 1493 1422 1791" style="list-style-type: none"> <li data-bbox="540 1493 1422 1604">1. When <i>LCID_SA</i> is a load curve ID, the curve is taken to be effective stress as a function of martensite fraction (ranging from 0 to 1). <li data-bbox="540 1646 1422 1791">2. When <i>LCID_SA</i> is a table ID, the table defines for each phase transition rate (derivative of martensite fraction) a load curve ID specifying the stress as a function of martensite fraction for that phase transition rate. The stress as a function of martensite fraction curve for the lowest value of the phase transition rate is used if the phase transition rate falls below the minimum value.

VARIABLE**DESCRIPTION**

Likewise, the stress as a function of martensite fraction curve for the highest value of phase transition rate is used if phase transition rate exceeds the maximum value.

3. The values of SIG_ASS and SIG_ASF are overwritten when this option is used.

Remarks:

The material parameter alpha, $-1 < \alpha < 1$, measures the difference between material responses in tension and compression. In particular, it is possible to relate the parameter α to the initial stress value of the austenite into martensite conversion from the expression

$$\alpha = \frac{-\sigma_s^{AS,-} - \sigma_s^{AS,+}}{-\sigma_s^{AS,-} + \sigma_s^{AS,+}}$$

where $\sigma_s^{AS,+} > 0$ and $\sigma_s^{AS,-} < 0$ are the values in tension and compression, respectively. From the input parameters α and $\sigma_s^{AS,+}$, the stress in compression is then

$$\sigma_s^{AS,-} = \frac{\alpha + 1}{\alpha - 1} \sigma_s^{AS,+}$$

In [Figure M30-2](#), we show the uniaxial Cauchy stress versus the logarithmic strain plot obtained from a simple test problem. The investigated problem is the complete loading-unloading test in tension and compression. We set the material properties to:

Property	Value	Property	Value
E	60000 MPa	SIG_SAF	200 MPa
PR	0.3	EPSL	0.07
SIG_ASS	520 MPa	ALPHA	0.12
SIG_ASF	600 MPa	YMRT	50000 MPa
SIG_SAS	300 MPa		

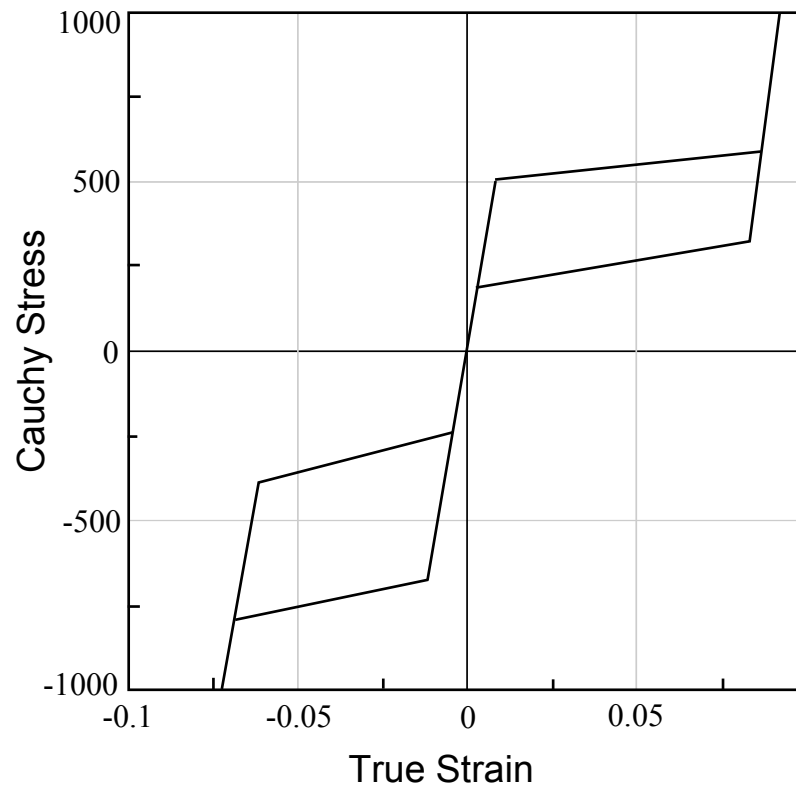

Figure M30-2. Complete loading-unloading test in tension and compression.

***MAT_FRAZER_NASH_RUBBER_MODEL**

This is Material Type 31. This model defines rubber from uniaxial test data. It is a modified form of the hyperelastic constitutive law first described in Kenchington [1988]. See Remarks below.

Card 1	1	2	3	4	5	6	7	8
Variable	MID	RO	PR	C100	C200	C300	C400	
Type	A	F	F	F	F	F	F	

Card 2	1	2	3	4	5	6	7	8
Variable	C110	C210	C010	C020	EXIT	EMAX	EMIN	REF
Type	F	F	F	F	F	F	F	F

Card 3	1	2	3	4	5	6	7	8
Variable	SGL	SW	ST	LCID				
Type	F	F	F	F				

VARIABLE**DESCRIPTION**

MID	Material identification. A unique number or label must be specified (see *PART).
RO	Mass density
PR	Poisson's ratio. Values between .49 and .50 are suggested.
C100	C_{100} , constant in strain energy functional. If a least squares fit is being used, set this constant to 1.0 if the term it belongs to in the strain energy functional is to be included. See Remarks.
C200	C_{200} , constant in strain energy functional. If a least squares fit is being used, set this constant to 1.0 if the term it belongs to in the strain energy functional is to be included. See Remarks.

VARIABLE	DESCRIPTION
C300	C_{300} , constant in strain energy functional. If a least squares fit is being used, set this constant to 1.0 if the term it belongs to in the strain energy functional is to be included. See Remarks.
C400	C_{400} , constant in strain energy functional. If a least squares fit is being used, set this constant to 1.0 if the term it belongs to in the strain energy functional is to be included. See Remarks.
C110	C_{110} , constant in strain energy functional. If a least squares fit is being used, set this constant to 1.0 if the term it belongs to in the strain energy functional is to be included. See Remarks.
C210	C_{210} , constant in strain energy functional. If a least squares fit is being used, set this constant to 1.0 if the term it belongs to in the strain energy functional is to be included. See Remarks.
C010	C_{010} , constant in strain energy functional. If a least squares fit is being used, set this constant to 1.0 if the term it belongs to in the strain energy functional is to be included. See Remarks.
C020	C_{020} , constant in strain energy functional. If a least squares fit is being used, set this constant to 1.0 if the term it belongs to in the strain energy functional is to be included. See Remarks.
EXIT	Exit option: EQ.0.0: stop if strain limits are exceeded (recommended) NE.0.0: continue if strain limits are exceeded. The curve is then extrapolated.
EMAX	Maximum strain limit, (Green-St, Venant Strain).
EMIN	Minimum strain limit, (Green-St, Venant Strain).
REF	Use reference geometry to initialize the stress tensor. The reference geometry is defined by the keyword: *INITIAL_FOAM_REFERENCE_GEOMETRY (see there for more details). EQ.0.0: off, EQ.1.0: on.
SGL	Specimen gauge length; see Figure M27-1 .
SW	Specimen width; see Figure M27-1 .

VARIABLE	DESCRIPTION
ST	Specimen thickness; see Figure M27-1 .
LCID	Load curve ID (see DEFINE_CURVE) giving the force as a function of actual change in gauge length. See also Figure M27-2 for an alternative definition.

Remarks:

The constants can be defined directly or a least squares fit can be performed if the uniaxial data (SGL, SW, ST and LCID) is available. *If a least squares fit is chosen, then the terms to be included in the energy functional are flagged by setting their corresponding coefficients to unity.* If all coefficients are zero, the default is to use only the terms involving I_1 and I_2 . C_{100} defaults to unity if the least square fit is used.

The strain energy functional U is defined in terms of the input constants as

$$U = C_{100}I_1 + C_{200}I_1^2 + C_{300}I_1^3 + C_{400}I_1^4 + C_{110}I_1I_2 + C_{210}I_1^2I_2 + C_{010}I_2 + C_{020}I_2^2 + f(J)$$

where the invariants I_1 , I_2 and J can be expressed in terms of the deformation gradient matrix, \mathbf{F} , and the right stretch tensor, $\mathbf{C} = \mathbf{F}^T \mathbf{F}$:

$$J = \det \mathbf{F}$$

$$I_1 = \text{tr}(\mathbf{C}) - 3$$

$$I_2 = \frac{1}{2} \left(\text{tr}(\mathbf{C})^2 - \text{tr}(\mathbf{C}^2) \right) - 3.$$

The dependence on the third invariant is given as

$$f(J) = \frac{2C_{100}(\nu - 4) + 4C_{010}(11\nu - 5)}{1 - 2\nu} \left(\frac{J^2}{2} - \ln J \right) + \frac{1}{2} (C_{100} + 2C_{010}) \frac{1}{J^4}$$

where ν is the Poisson's ratio. The first term on the right-hand side of this expression should be interpreted as the constitutive law for the pressure while the second is necessary for providing zero stress at the reference configuration.

The derivative of U with respect to \mathbf{C} gives the 2nd Piola-Kirchhoff stress \mathbf{S} as

$$\mathbf{S} = 2 \frac{\partial U}{\partial \mathbf{C}}$$

and the Cauchy stress $\boldsymbol{\sigma}$ is then given by

$$\boldsymbol{\sigma} = \frac{1}{J} \mathbf{F} \mathbf{S} \mathbf{F}^T.$$

The load curve definition that provides the uniaxial data should give the change in gauge length, ΔL , and the corresponding force. In compression both the force and the change in gauge length must be specified as negative values. In tension the force and change in

gauge length should be input as positive values. The principal stretch ratio in the uniaxial direction, λ_1 , is then given by

$$\lambda_1 = \frac{L_o + \Delta L}{L_o}$$

Alternatively, the stress as a function of strain curve can also be input by setting the gauge length, thickness, and width to unity and defining the engineering strain in place of the change in gauge length and the nominal (engineering) stress in place of the force; see [Figure M27-2](#). The least square fit to the experimental data is performed during the initialization phase, and a comparison between the fit and the actual input is provided in the printed file. It is a good idea to visually check the fit to make sure it is acceptable. The coefficients C_{100} through C_{020} are also printed in the output file.

***MAT_LAMINATED_GLASS**

This is Material Type 32. With this material model, a layered glass including polymeric layers can be modeled. Failure of the glass part is possible. See notes below.

Card 1	1	2	3	4	5	6	7	8
Variable	MID	RO	EG	PRG	SYG	ETG	EFG	EP
Type	A	F	F	F	F	F	F	F

Card 2	1	2	3	4	5	6	7	8
Variable	PRP	SYP	ETP					
Type	F	F	F					

Integration Point Cards. Up to four of this card (specifying up to 32 values) may be input. This input is terminated by the next keyword ("*") card.

Card 3	1	2	3	4	5	6	7	8
Variable	F1	F2	F3	F4	F5	F6	F7	F8
Type	F	F	F	F	F	F	F	F

VARIABLE**DESCRIPTION**

MID	Material identification. A unique number or label must be specified (see *PART).
RO	Mass density
EG	Young's modulus for glass
PRG	Poisson's ratio for glass
SYG	Yield stress for glass
ETG	Plastic hardening modulus for glass

VARIABLE	DESCRIPTION
EFG	Plastic strain at failure for glass
EP	Young's modulus for polymer
PRP	Poisson's ratio for polymer
SYP	Yield stress for polymer
ETP	Plastic hardening modulus for polymer
F1, ..., FN	Integration point material: EQ.0.0: glass (default) EQ.1.0: polymer A user-defined integration rule must be specified; see *INTEGRATION_SHELL. See Remarks below.

Remarks:

Isotropic hardening for both materials is assumed. The material to which the glass is bonded is assumed to stretch plastically without failure. A user defined integration rule specifies the thickness of the layers making up the glass. F_i defines whether the integration point is glass (0.0) or polymer (1.0). The material definition, F_i , must be given for the same number of integration points (NIPTS) as specified in the rule. A maximum of 32 layers is allowed.

If the recommended user defined rule is not defined, the default integration rules are used. The location of the integration points in the default rules are defined in the *SECTION_SHELL keyword description.

***MAT_BARLAT_ANISOTROPIC_PLASTICITY**

This is Material Type 33. This model was developed by Barlat, Lege, and Brem [1991] for modeling anisotropic material behavior in forming processes. The finite element implementation of this model is described in detail by Chung and Shah [1992] and is used here. It is based on a six parameter model, which is ideally suited for 3D continuum problems (see remarks below). For sheet forming problems, we recommend material 36 which is based on a 3-parameter model.

This material is available for shell, thick shell, and solid elements.

Card 1	1	2	3	4	5	6	7	8
Variable	MID	RO	E	PR	K	E0	N	M
Type	A	F	F	F	F	F	F	F

Card 2	1	2	3	4	5	6	7	8
Variable	A	B	C	F	G	H	LCID	
Type	F	F	F	F	F	F	F	

Card 3	1	2	3	4	5	6	7	8
Variable	AOPT	BETA	MACF					
Type	F	F	I					

Card 4	1	2	3	4	5	6	7	8
Variable	XP	YP	ZP	A1	A2	A3		
Type	F	F	F	F	F	F		

Card 5	1	2	3	4	5	6	7	8
Variable	V1	V2	V3	D1	D2	D3		
Type	F	F	F	F	F	F		

VARIABLE**DESCRIPTION**

MID	Material identification. A unique number or label must be specified (see *PART).
RO	Mass density
E	Young's modulus, E
PR	Poisson's ratio, ν
K	k , strength coefficient (see remarks below)
E0	ϵ_0 , strain corresponding to the initial yield (see remarks below)
N	n , hardening exponent for yield strength
M	m , flow potential exponent in Barlat's Model
A	a , anisotropy coefficient in Barlat's Model
B	b , anisotropy coefficient in Barlat's Model
C	c , anisotropy coefficient in Barlat's Model
F	f , anisotropy coefficient in Barlat's Model
G	g , anisotropy coefficient in Barlat's Model
H	h , anisotropy coefficient in Barlat's Model
LCID	Option load curve ID defining effective stress as a function of effective plastic strain. If nonzero, this curve will be used to define the yield stress. The load curve is implemented for solid elements only.
AOPT	Material axes option (see MAT_OPTIONTROPIC_ELASTIC, particularly the Material Directions section, for details):

VARIABLE	DESCRIPTION
EQ.0.0:	Locally orthotropic with material axes determined by element nodes 1, 2, and 4, as with *DEFINE_COORDINATE_NODES. For shells only, the material axes are then rotated about the normal vector to the surface of the shell by the angle BETA.
EQ.1.0:	Locally orthotropic with material axes determined by a point, P , in space and the global location of the element center; this is the a -direction. This option is for solid elements only.
EQ.2.0:	Globally orthotropic with material axes determined by vectors defined below, as with *DEFINE_COORDINATE_VECTOR
EQ.3.0:	Locally orthotropic material axes determined by a vector \mathbf{v} and the normal vector to the plane of the element. The plane of a solid element is the midsurface between the inner surface and outer surface defined by the first four nodes and the last four nodes of the connectivity of the element, respectively. Thus, for solid elements, AOPT = 3 is only available for hexahedrons. \mathbf{a} is determined by taking the cross product of \mathbf{v} with the normal vector, \mathbf{b} is determined by taking the cross product of the normal vector with \mathbf{a} , and \mathbf{c} is the normal vector. Then \mathbf{a} and \mathbf{b} are rotated about \mathbf{c} by an angle BETA. BETA may be set in the keyword input for the element or in the input for this keyword. Note that for solids, the material axes may be switched depending on the choice of MACF. The switch may occur before or after applying BETA depending on the value of MACF.
EQ.4.0:	Locally orthotropic in a cylindrical coordinate system with the material axes determined by a vector \mathbf{v} , and an originating point, P , which define the centerline axis. This option is for solid elements only.
LT.0.0:	The absolute value of AOPT is a coordinate system ID number (CID on *DEFINE_COORDINATE_OPTION).
BETA	Material angle in degrees for AOPT = 1 (shells only) and AOPT = 3, may be overridden on the element card, see *ELEMENT_SHELL_BETA, *ELEMENT_TSHELL_BETA, or *ELEMENT_SOLID_ORTHO.

VARIABLE	DESCRIPTION
MACF	<p>Material axes change flag for solid elements:</p> <p>EQ.-4: Switch material axes b and c before BETA rotation</p> <p>EQ.-3: Switch material axes a and c before BETA rotation</p> <p>EQ.-2: Switch material axes a and b before BETA rotation</p> <p>EQ.1: No change, default</p> <p>EQ.2: Switch material axes a and b after BETA rotation</p> <p>EQ.3: Switch material axes a and c after BETA rotation</p> <p>EQ.4: Switch material axes b and c after BETA rotation</p> <p>Figure M2-2 indicates when LS-DYNA applies MACF during the process to obtain the final material axes. If BETA on *ELEMENT_SOLID_{OPTION} is defined, then that BETA is used for the rotation for all AOPT options. Otherwise, if AOPT = 3, the BETA input on Card 3 rotates the axes. For all other values of AOPT, the material axes will be switched as specified by MACF, but no BETA rotation will be performed.</p>
XP, YP, ZP	Coordinates of point p for AOPT = 1 and 4
A1, A2, A3	Components of vector \mathbf{a} for AOPT = 2
V1, V2, V3	Components of vector \mathbf{v} for AOPT = 3 and 4
D1, D2, D3	Components of vector \mathbf{d} for AOPT = 2

Remarks:

The yield function Φ is defined as:

$$\Phi = |S_1 - S_2|^m + |S_2 - S_3|^m + |S_3 - S_1|^m = 2\bar{\sigma}^m$$

where $\bar{\sigma}$ is the effective stress and $S_{i=1,2,3}$ are the principal values of the symmetric matrix $S_{\alpha\beta}$,

$$\begin{aligned} S_{xx} &= [c(\sigma_{xx} - \sigma_{yy}) - b(\sigma_{zz} - \sigma_{xx})]/3, & S_{yz} &= f\sigma_{yz} \\ S_{yy} &= [a(\sigma_{yy} - \sigma_{zz}) - c(\sigma_{xx} - \sigma_{yy})]/3, & S_{zx} &= g\sigma_{zx} \\ S_{zz} &= [b(\sigma_{zz} - \sigma_{xx}) - a(\sigma_{yy} - \sigma_{zz})]/3, & S_{xy} &= h\sigma_{xy} \end{aligned}$$

The material constants a, b, c, f, g and h represent anisotropic properties. When

$$a = b = c = f = g = h = 1,$$

the material is isotropic and the yield surface reduces to the Tresca yield surface for $m = 1$ and von Mises yield surface for $m = 2$ or 4 .

For face centered cubic (FCC) materials $m = 8$ is recommended and for body centered cubic (BCC) materials $m = 6$ is used. The yield strength of the material is

$$\sigma_y = k(\varepsilon^p + \varepsilon_0)^n ,$$

where ε_0 is the strain corresponding to the initial yield stress and ε^p is the plastic strain.

***MAT_BARLAT_YLD96**

This is Material Type 33. This model was developed by Barlat, Maeda, Chung, Yanagawa, Brem, Hayashida, Lege, Matsui, Murtha, Hattori, Becker, and Makosey [1997] for modeling anisotropic material behavior in forming processes in particular for aluminum alloys. This model is available for shell elements only.

Card Summary:

Card 1. This card is required.

MID	RO	E	PR	K			
-----	----	---	----	---	--	--	--

Card 2. This card is required.

E0	N	ESR0	M	HARD	A		
----	---	------	---	------	---	--	--

Card 3. This card is required.

C1	C2	C3	C4	AX	AY	AZ0	AZ1
----	----	----	----	----	----	-----	-----

Card 4. This card is required.

AOPT	BETA						
------	------	--	--	--	--	--	--

Card 5. This card is required.

			A1	A2	A3		
--	--	--	----	----	----	--	--

Card 6. This card is required.

V1	V2	V3	D1	D2	D3		
----	----	----	----	----	----	--	--

Data Card Definitions:

Card 1	1	2	3	4	5	6	7	8
Variable	MID	RO	E	PR	K			
Type	A	F	F	F	F			

VARIABLE	DESCRIPTION
MID	Material identification. A unique number or label must be specified (see *PART).
RO	Mass density
E	Young's modulus, E
PR	Poisson's ratio, ν
K	k , strength coefficient or a in Voce (see remarks below)

Card 2	1	2	3	4	5	6	7	8
Variable	E0	N	ESR0	M	HARD	A		
Type	F	F	F	F	F	F		

VARIABLE	DESCRIPTION
E0	ϵ_0 , strain corresponding to the initial yield or b in Voce (see remarks below)
N	n , hardening exponent for yield strength or c in Voce
ESR0	ϵ_{SR0} , in power law rate sensitivity
M	m , exponent for strain rate effects
HARD	Hardening option: LT.0.0: Absolute value defines the load curve ID EQ.1.0: Power law EQ.2.0: Voce
A	Flow potential exponent

Card 3	1	2	3	4	5	6	7	8
Variable	C1	C2	C3	C4	AX	AY	AZ0	AZ1
Type	F	F	F	F	F	F	F	F

VARIABLE**DESCRIPTION**

C1	c_1 , see remarks below
C2	c_2 , see remarks below
C3	c_3 , see remarks below
C4	c_4 , see remarks below
AX	a_x , see remarks below
AY	a_y , see remarks below
AZ0	a_{z_0} , see remarks below
AZ1	a_{z_1} , see remarks below

Card 4	1	2	3	4	5	6	7	8
Variable	AOPT	BETA						
Type	F	F						

VARIABLE**DESCRIPTION**

AOPT	Material axes option: <p>EQ.0.0: Locally orthotropic with material axes determined by element nodes 1, 2, and 4, as with *DEFINE_COORDINATE_NODES, and then rotated about the shell element normal by an angle BETA</p> <p>EQ.2.0: Globally orthotropic with material axes determined by vectors defined below, as with *DEFINE_COORDINATE_VECTOR</p>
------	--

VARIABLE

DESCRIPTION

EQ.3.0: Locally orthotropic material axes determined by offsetting the material axes by an angle, BETA, from a line determined by taking the cross product of the vector **v** with the normal to the plane of the element

LT.0.0: The absolute value of AOPT is a coordinate system ID number (CID on *DEFINE_COORDINATE_NODES, *DEFINE_COORDINATE_SYSTEM or *DEFINE_COORDINATE_VECTOR).

BETA Material angle in degrees for AOPT = 0 and 3. BETA may be overridden on the element card; see *ELEMENT_SHELL_BETA.

Card 5	1	2	3	4	5	6	7	8
Variable				A1	A2	A3		
Type				F	F	F		

VARIABLE

DESCRIPTION

A1, A2, A3 Components of vector **a** for AOPT = 2

Card 6	1	2	3	4	5	6	7	8
Variable	V1	V2	V3	D1	D2	D3		
Type	F	F	F	F	F	F		

VARIABLE

DESCRIPTION

V1, V2, V3 Components of vector **v** for AOPT = 3

D1, D2, D3 Components of vector **d** for AOPT = 2

Remarks:

The yield stress σ_y is defined three ways. The first, the Swift equation, is given in terms of the input constants as:

$$\sigma_y = k(\varepsilon_0 + \varepsilon^p)^n \left(\frac{\dot{\varepsilon}}{\varepsilon_{SR0}} \right)^m .$$

The second, the Voce equation, is defined as:

$$\sigma_y = a - be^{-c\varepsilon^p} .$$

The third option is to give a load curve ID that defines the yield stress as a function of effective plastic strain.

The yield function Φ is defined as:

$$\Phi = \alpha_1 |s_1 - s_2|^a + \alpha_2 |s_2 - s_3|^a + \alpha_3 |s_3 - s_1|^a = 2\sigma_y^a ,$$

Here s_i is a principle component of the deviatoric stress tensor. In vector notation:

$$\mathbf{s} = \mathbf{L}\boldsymbol{\sigma} ,$$

where \mathbf{L} is given as

$$\mathbf{L} = \begin{bmatrix} \frac{c_2 + c_3}{3} & \frac{-c_3}{3} & \frac{-c_2}{3} & 0 \\ \frac{-c_3}{3} & \frac{c_3 + c_1}{3} & \frac{-c_1}{3} & 0 \\ \frac{-c_2}{3} & \frac{-c_1}{3} & \frac{c_1 + c_2}{3} & 0 \\ 0 & 0 & 0 & c_4 \end{bmatrix}$$

A coordinate transformation relates the material frame to the principle directions of \mathbf{s} is used to obtain the α_k coefficients consistent with the rotated principle axes:

$$\alpha_k = \alpha_x p_{1k}^2 + \alpha_y p_{2k}^2 + \alpha_z p_{3k}^2$$

$$\alpha_z = \alpha_{z0} \cos^2(2\beta) + \alpha_{z1} \sin^2(2\beta)$$

where p_{ij} are components of the transformation matrix. The angle β defines a measure of the rotation between the frame of the principal value of \mathbf{s} and the principal anisotropy axes.

***MAT_FABRIC**

This is Material Type 34. This material is especially developed for airbag materials. The fabric model is a variation on the layered orthotropic composite model of material 22 and is valid for 3 and 4 node membrane elements only.

In addition to being a constitutive model, this model also invokes a special membrane element formulation which is more suited to the deformation experienced by fabrics under large deformation. For thin fabrics, buckling can result in an inability to support compressive stresses; thus a flag is included for this option. A linearly elastic liner is also included which can be used to reduce the tendency for these elements to be crushed when the no-compression option is invoked. In LS-DYNA versions after 931 the isotropic elastic option is available.

Card Summary:

Card 1. This card is required.

MID	RO	EA	EB		PRBA	PRAB	
-----	----	----	----	--	------	------	--

Card 2. This card is required.

GAB			CSE	EL	PRL	LRATIO	DAMP
-----	--	--	-----	----	-----	--------	------

Card 3a. This card is included if $0 < X0 < 1$ (see Card 5).

AOPT	X2	X3	ELA	LNRC	FORM	FVOPT	TSRFAC
------	----	----	-----	------	------	-------	--------

Card 3b. This card is included if $X0 = 0$ or $X0 = -1$ (see Card 5) and $FVOPT < 7$.

AOPT	FLC	FAC	ELA	LNRC	FORM	FVOPT	TSRFAC
------	-----	-----	-----	------	------	-------	--------

Card 3c. This card is included if $X0 = 0$ or $X0 = -1$ (see Card 5) and $FVOPT \geq 7$.

AOPT	FLC	FAC	ELA	LNRC	FORM	FVOPT	TSRFAC
------	-----	-----	-----	------	------	-------	--------

Card 3d. This card is included if $X0 = 1$ (see Card 5) and $FVOPT < 7$.

AOPT	FLC	FAC	ELA	LNRC	FORM	FVOPT	TSRFAC
------	-----	-----	-----	------	------	-------	--------

Card 3e. This card is included if $X0 = 1$ (see Card 5) and $FVOPT \geq 7$.

AOPT	FLC	FAC	ELA	LNRC	FORM	FVOPT	TSRFAC
------	-----	-----	-----	------	------	-------	--------

Card 4. This card is included if FVOPT < 0.

L	R	C1	C2	C3			
---	---	----	----	----	--	--	--

Card 5. This card is required.

	RGBRTH	AOREF	A1	A2	A3	X0	X1
--	--------	-------	----	----	----	----	----

Card 6. This card is required.

V1	V2	V3				BETA	ISREFG
----	----	----	--	--	--	------	--------

Card 7. This card is included if FORM = 4, 14, or -14.

LCA	LCB	LCAB	LCUA	LCUB	LCUAB	RL	
-----	-----	------	------	------	-------	----	--

Card 8. This card is included if FORM = -14.

LCAA	LCBB	H	DT		ECOAT	SCOAT	TCOAT
------	------	---	----	--	-------	-------	-------

Data Card Definitions:

Card 1	1	2	3	4	5	6	7	8
Variable	MID	RO	EA	EB		PRBA	PRAB	
Type	A	F	F	F		F	F	

VARIABLE

DESCRIPTION

MID	Material identification. A unique number or label must be specified (see *PART).
RO	Mass density
EA	Young's modulus - longitudinal direction. For an isotropic elastic fabric material, <i>only</i> EA and PRBA are defined; they are used as the isotropic Young's modulus and Poisson's ratio, respectively. The input for the fiber directions and liner should be input as zero for the isotropic elastic fabric.
EB	Young's modulus - transverse direction, set to zero for isotropic elastic material.

<u>VARIABLE</u>	<u>DESCRIPTION</u>
-----------------	--------------------

PRBA	ν_{ba} , Minor Poisson's ratio <i>ba</i> direction
PRAB	ν_{ab} , Major Poisson's ratio <i>ab</i> direction (see Remark 15)

Card 2	1	2	3	4	5	6	7	8
Variable	GAB			CSE	EL	PRL	LRATIO	DAMP
Type	F			F	F	F	F	F
Remarks				1	4	4	4	

<u>VARIABLE</u>	<u>DESCRIPTION</u>
-----------------	--------------------

GAB	G_{ab} , shear modulus in the <i>ab</i> direction. Set to zero for an isotropic elastic material.
CSE	Compressive stress elimination option (see Remark 1): EQ.0.0: Do not eliminate compressive stresses (<i>default</i>). EQ.1.0: Eliminate compressive stresses. This option does not apply to the liner.
EL	Young's modulus for elastic liner (required if LRATIO > 0)
PRL	Poisson's ratio for elastic liner (required if LRATIO > 0)
LRATIO	A non-zero value activates the elastic liner and defines the ratio of liner thickness to total fabric thickness (optional).
DAMP	Rayleigh damping coefficient. A 0.05 coefficient is recommended corresponding to 5% of critical damping. Sometimes larger values are necessary.

This card is included if and only if $0 < X0 < 1$ (see Card 5).

Card 3a	1	2	3	4	5	6	7	8
Variable	AOPT	X2	X3	ELA	LNRC	FORM	FVOPT	TSRFAC
Type	F	F	F	F	F	F	F	F

VARIABLE	DESCRIPTION
AOPT	<p>Material axes option (see MAT_OPTIONTROPIC_ELASTIC for a more complete description). Also, please refer to Remark 5 for additional information specific to fiber directions for fabrics:</p> <p>EQ.0.0: Locally orthotropic with material axes determined by element nodes 1, 2, and 4, as with *DEFINE_COORDINATE_NODES, and then rotated about the element normal by an angle BETA</p> <p>EQ.2.0: Globally orthotropic with material axes determined by vectors defined below, as with *DEFINE_COORDINATE_VECTOR</p> <p>EQ.3.0: Locally orthotropic material axes determined by rotating the material axes about the element normal by an angle, BETA, from a line in the plane of the element defined by the cross product of the vector \mathbf{v} with the element normal</p> <p>LT.0.0: The absolute value of AOPT is a coordinate system ID number (CID on *DEFINE_COORDINATE_NODES, *DEFINE_COORDINATE_SYSTEM or *DEFINE_COORDINATE_VECTOR). Available in R3 version of 971 and later.</p>
X2	Coefficient of the porosity from the equation in Anagonye and Wang [1999]
X3	Coefficient of the porosity equation of Anagonye and Wang [1999]
ELA	<p>Effective leakage area for blocked fabric, ELA (see Remark 3):</p> <p>LT.0.0: ELA is the load curve ID of the curve defining ELA as a function of time. The default value of zero assumes that no leakage occurs. A value of .10 would assume that 10% of the blocked fabric is leaking gas.</p>
LNRC	<p>Flag to turn off compression in liner until the reference geometry is reached, that is, the fabric element becomes tensile (see Remark 4):</p> <p>EQ.0.0: Off</p> <p>EQ.1.0: On</p> <p>EQ.2.0: Liner's resistance force follows the strain restoration factor, TSRFAC.</p>
FORM	Flag to modify membrane formulation for fabric material:

VARIABLE	DESCRIPTION
	EQ.0.0: Default. Least costly and very reliable.
	EQ.1.0: Invariant local membrane coordinate system
	EQ.2.0: Green-Lagrange strain formulation
	EQ.3.0: Large strain with nonorthogonal material angles. See Remark 5 .
	EQ.4.0: Large strain with nonorthogonal material angles and nonlinear stress strain behavior. Define optional load curve IDs on optional card.
	EQ.12.0: Enhanced version of formulation 2. See Remark 11 .
	EQ.13.0: Enhanced version of formulation 3. See Remark 11 .
	EQ.14.0: Enhanced version of formulation 4. See Remark 11 .
	EQ.-14.0: Same as formulation 14 but invokes reading of Card 8. See Remark 14 .
	EQ.24.0: Enhanced version of formulation 14. See Remark 11 .
FVOPT	Fabric venting option (see Remark 9).
	EQ.1: Wang-Nefske formulas for venting through an orifice are used. Blockage is not considered.
	EQ.2: Wang-Nefske formulas for venting through an orifice are used. Blockage of venting area due to contact is considered.
	EQ.3: Leakage formulas of Graefe, Krummheuer, and Siejak [1990] are used. Blockage is not considered.
	EQ.4: Leakage formulas of Graefe, Krummheuer, and Siejak [1990] are used. Blockage of venting area due to contact is considered.
	EQ.5: Leakage formulas based on flow through a porous media are used. Blockage is not considered.
	EQ.6: Leakage formulas based on flow through a porous media are used. Blockage of venting area due to contact is considered.
	EQ.7: Leakage is based on gas volume outflow versus pressure load curve [Lian, 2000]. Blockage is not considered. Absolute pressure is used in the porous-velocity-versus-pressure load curve, given as FAC in the *MAT_FABRIC card.

VARIABLE	DESCRIPTION
----------	-------------

EQ.8: Leakage is based on gas volume outflow versus pressure load curve [Lian 2000]. Blockage of venting or porous area due to contact is considered. Absolute pressure is used in the porous-velocity-versus-pressure load curve, given as FAC in the *MAT_FABRIC card.

LT.0: |FVOPT| defines the same fabric venting options as above, but a new formula for the leakage area is used to replace the element area. See [Remark 16](#).

Note: See [Remark 17](#) for FVOPT option for CPM (*AIRBAG_PARTICLE) bags.

TSRFAC

Strain restoration factor (see [Remark 10](#)):

LT.0: |TSRFAC| is the ID of a curve defining TSRFAC as a function of time.

GT.0 and LT.1: TSRFAC applied from time 0.

GT.1: TSRFAC is the ID of a curve that defines TSRFAC as a function of time using an alternate method (not available for FORM = 0 or 1).

This card is included if X0 = 0 or X = -1 and FVOPT < 7.

Card 3b	1	2	3	4	5	6	7	8
Variable	AOPT	FLC	FAC	ELA	LNRC	FORM	FVOPT	TSRFAC
Type	F	F	F	F	F	F	F	F
Remarks		2	2	3	4	11	9	10

VARIABLE	DESCRIPTION
----------	-------------

AOPT

Material axes option (see MAT_OPTIONTROPIC_ELASTIC for a more complete description). Also, please refer to [Remark 5](#) for additional information specific to fiber directions for fabrics:

EQ.0.0: Locally orthotropic with material axes determined by element nodes 1, 2, and 4, as with *DEFINE_COORDINATE_NODES, and then rotated about the element normal by an angle BETA

VARIABLE	DESCRIPTION
	EQ.2.0: Globally orthotropic with material axes determined by vectors defined below, as with *DEFINE_COORDINATE_VECTOR
	EQ.3.0: Locally orthotropic material axes determined by rotating the material axes about the element normal by an angle, BETA, from a line in the plane of the element defined by the cross product of the vector \mathbf{v} with the element normal
	LT.0.0: The absolute value of AOPT is a coordinate system ID number (CID on *DEFINE_COORDINATE_NODES, *DEFINE_COORDINATE_SYSTEM or *DEFINE_COORDINATE_VECTOR). Available in R3 version of 971 and later.
FLC	Optional porous leakage flow coefficient. (See theory manual.) GE.0: Porous leakage flow coefficient. LT.0: FLC is interpreted as a load curve ID defining FLC as a function of time.
FAC	Optional characteristic fabric parameter. (See theory manual.) GE.0: Characteristic fabric parameter LT.0: FAC is interpreted as a load curve ID defining FAC as a function of absolute pressure.
ELA	Effective leakage area for blocked fabric, ELA (see Remark 3): LT.0.0: ELA is the load curve ID of the curve defining ELA as a function of time. The default value of zero assumes that no leakage occurs. A value of .10 would assume that 10% of the blocked fabric is leaking gas.
LNRC	Flag to turn off compression in liner until the reference geometry is reached, that is, the fabric element becomes tensile: EQ.0.0: Off EQ.1.0: On
FORM	Flag to modify membrane formulation for fabric material: EQ.0.0: Default. Least costly and very reliable. EQ.1.0: Invariant local membrane coordinate system EQ.2.0: Green-Lagrange strain formulation

VARIABLE	DESCRIPTION
EQ.3.0:	Large strain with nonorthogonal material angles. See Remark 5 .
EQ.4.0:	Large strain with nonorthogonal material angles and nonlinear stress strain behavior. Define optional load curve IDs on optional card.
EQ.12.0:	Enhanced version of formulation 2. See Remark 11 .
EQ.13.0:	Enhanced version of formulation 3. See Remark 11 .
EQ.14.0:	Enhanced version of formulation 4. See Remark 11 .
EQ.-14.0:	Same as formulation 14 but invokes reading of Card 8. See Remark 14 .
EQ.24.0:	Enhanced version of formulation 14. See Remark 11 .
FVOPT	Fabric venting option.
EQ.1:	Wang-Nefske formulas for venting through an orifice are used. Blockage is not considered.
EQ.2:	Wang-Nefske formulas for venting through an orifice are used. Blockage of venting area due to contact is considered.
EQ.3:	Leakage formulas of Graefe, Krummheuer, and Siejak [1990] are used. Blockage is not considered.
EQ.4:	Leakage formulas of Graefe, Krummheuer, and Siejak [1990] are used. Blockage of venting area due to contact is considered.
EQ.5:	Leakage formulas based on flow through a porous media are used. Blockage is not considered.
EQ.6:	Leakage formulas based on flow through a porous media are used. Blockage of venting area due to contact is considered.
LT.0:	FVOPT defines the same fabric venting options as above, but a new formula for the leakage area is used to replace the element area. See Remark 16 .
Note: See Remark 17 for FVOPT option for CPM (*AIRBAG_PARTICLE) bags.	
TSRFAC	Strain restoration factor:
LT.0:	TSRFAC is the ID of a curve defining TSRFAC as a function of time.

VARIABLE

DESCRIPTION

GT.0 and LT.1: TSRFAC applied from time 0.

GE.1: TSRFAC is the ID of a curve that defines TSRFAC as a function of time using an alternate method (not available for FORM = 0 or 1).

This card is included if and only if X0 = 0 or X0 = -1 and FVOPT ≥ 7.

Card 3c	1	2	3	4	5	6	7	8
Variable	AOPT	FLC	FAC	ELA	LNRC	FORM	FVOPT	TSRFAC
Type	F	F	F	F	F	F	F	F
Remarks		2	2	3	4	11	9	10

VARIABLE

DESCRIPTION

AOPT

Material axes option (see MAT_OPTIONTROPIC_ELASTIC for a more complete description). Also, please refer to Remark 5 for additional information specific to fiber directions for fabrics:

EQ.0.0: Locally orthotropic with material axes determined by element nodes 1, 2, and 4, as with *DEFINE_COORDINATE_NODES, and then rotated about the element normal by an angle BETA

EQ.2.0: Globally orthotropic with material axes determined by vectors defined below, as with *DEFINE_COORDINATE_VECTOR

EQ.3.0: Locally orthotropic material axes determined by rotating the material axes about the element normal by an angle, BETA, from a line in the plane of the element defined by the cross product of the vector v with the element normal

LT.0.0: The absolute value of AOPT is a coordinate system ID number (CID on *DEFINE_COORDINATE_NODES, *DEFINE_COORDINATE_SYSTEM or *DEFINE_COORDINATE_VECTOR). Available in R3 version of 971 and later.

FLC

Optional porous leakage flow coefficient. (See theory manual.)

GE.0: Porous leakage flow coefficient

VARIABLE	DESCRIPTION
	LT.0: FLC is interpreted as a load curve ID defining FLC as a function of time.
FAC	Optional characteristic fabric parameter. (See theory manual.) GE.0: Characteristic fabric parameter LT.0: FAC is interpreted as a load curve ID giving <i>leakage volume flux rate</i> as a function of absolute pressure. The volume flux (per area) rate (per time) has the dimensions of $d(\text{vol}_{\text{flux}})/dt \approx [\text{length}]^3/([\text{length}]^2[\text{time}])$ $\approx [\text{length}]/[\text{time}],$ equivalent to relative porous gas speed.
ELA	Effective leakage area for blocked fabric, ELA (see Remark 3): LT.0.0: ELA is the load curve ID of the curve defining ELA as a function of time. The default value of zero assumes that no leakage occurs. A value of .10 would assume that 10% of the blocked fabric is leaking gas.
LNRC	Flag to turn off compression in liner until the reference geometry is reached, that is, the fabric element becomes tensile: EQ.0.0: Off EQ.1.0: On
FORM	Flag to modify membrane formulation for fabric material: EQ.0.0: Default. Least costly and very reliable. EQ.1.0: Invariant local membrane coordinate system EQ.2.0: Green-Lagrange strain formulation EQ.3.0: Large strain with nonorthogonal material angles. See Remark 5 . EQ.4.0: Large strain with nonorthogonal material angles and nonlinear stress strain behavior. Define optional load curve IDs on optional card. EQ.12.0: Enhanced version of formulation 2. See Remark 11 . EQ.13.0: Enhanced version of formulation 3. See Remark 11 . EQ.14.0: Enhanced version of formulation 4. See Remark 11 .

VARIABLE	DESCRIPTION
	EQ.-14.0: Same as formulation 14 but invokes reading of Card 8. See Remark 14 .
	EQ.24.0: Enhanced version of formulation 14. See Remark 11 .
FVOPT	Fabric venting option: EQ.7: Leakage is based on gas volume outflow versus pressure load curve [Lian, 2000]. Blockage is not considered. Absolute pressure is used in the porous-velocity-versus-pressure load curve, given as FAC in the *MAT_FABRIC card. EQ.8: Leakage is based on gas volume outflow versus pressure load curve [Lian 2000]. Blockage of venting or porous area due to contact is considered. Absolute pressure is used in the porous-velocity-versus-pressure load curve, given as FAC in the *MAT_FABRIC card. Note: See Remark 17 for FVOPT option for CPM (*AIRBAG_PARTICLE) bags.
TSRFAC	Strain restoration factor: LT.0: TSRFAC is the ID of a curve defining TSRFAC as a function of time. GT.0 and LT.1: TSRFAC applied from time 0. GE.1: TSRFAC is the ID of a curve that defines TSRFAC as a function of time using an alternate method (not available for FORM = 0 or 1).
ELA	Effective leakage area for blocked fabric, ELA (see Remark 3): LT.0.0: ELA is the load curve ID of the curve defining ELA as a function of time. The default value of zero assumes that no leakage occurs. A value of .10 would assume that 10% of the blocked fabric is leaking gas.

This card is included if $X0 = 1$ and $FVOPT < 7$.

Card 3d	1	2	3	4	5	6	7	8
Variable	AOPT	FLC	FAC	ELA	LNRC	FORM	FVOPT	TSRFAC
Type	F	F	F	F	F	F	F	F
Remarks		2	2	3	4	11	9	10

VARIABLE**DESCRIPTION**

AOPT

Material axes option (see `MAT_OPTIONTROPIC_ELASTIC` for a more complete description). Also, please refer to [Remark 5](#) for additional information specific to fiber directions for fabrics:

EQ.0.0: Locally orthotropic with material axes determined by element nodes 1, 2, and 4, as with `*DEFINE_COORDINATE_NODES`, and then rotated about the element normal by an angle BETA

EQ.2.0: Globally orthotropic with material axes determined by vectors defined below, as with `*DEFINE_COORDINATE_VECTOR`

EQ.3.0: Locally orthotropic material axes determined by rotating the material axes about the element normal by an angle, BETA, from a line in the plane of the element defined by the cross product of the vector \mathbf{v} with the element normal

LT.0.0: The absolute value of AOPT is a coordinate system ID number (CID on `*DEFINE_COORDINATE_NODES`, `*DEFINE_COORDINATE_SYSTEM` or `*DEFINE_COORDINATE_VECTOR`). Available in R3 version of 971 and later.

FLC

Optional porous leakage flow coefficient. (See theory manual.)

GE.0: Porous leakage flow coefficient.

LT.0: $|FLC|$ is interpreted as a load curve ID defining FLC as a function of the stretching ratio defined as $r_s = A/A_0$. See notes below.

FAC

Optional characteristic fabric parameter. (See theory manual.)

GE.0: Characteristic fabric parameter

VARIABLE	DESCRIPTION
	LT.0: FAC is interpreted as a load curve defining FAC as a function of the pressure ratio $r_p = P_{air}/P_{bag}$. See Remark 2 below.
ELA	Effective leakage area for blocked fabric, ELA (see Remark 3): LT.0.0: ELA is the load curve ID of the curve defining ELA as a function of time. The default value of zero assumes that no leakage occurs. A value of .10 would assume that 10% of the blocked fabric is leaking gas.
LNRC	Flag to turn off compression in liner until the reference geometry is reached, that is, the fabric element becomes tensile: EQ.0.0: Off EQ.1.0: On
FORM	Flag to modify membrane formulation for fabric material: EQ.0.0: Default. Least costly and very reliable. EQ.1.0: Invariant local membrane coordinate system EQ.2.0: Green-Lagrange strain formulation EQ.3.0: Large strain with nonorthogonal material angles. See Remark 5 . EQ.4.0: Large strain with nonorthogonal material angles and nonlinear stress strain behavior. Define optional load curve IDs on optional card. EQ.12.0: Enhanced version of formulation 2. See Remark 11 . EQ.13.0: Enhanced version of formulation 3. See Remark 11 . EQ.14.0: Enhanced version of formulation 4. See Remark 11 . EQ.-14.0: Same as formulation 14 but invokes reading of Card 8. See Remark 14 . EQ.24.0: Enhanced version of formulation 14. See Remark 11 .
FVOPT	Fabric venting option. EQ.1: Wang-Nefske formulas for venting through an orifice are used. Blockage is not considered.

VARIABLE	DESCRIPTION
	EQ.2: Wang-Nefske formulas for venting through an orifice are used. Blockage of venting area due to contact is considered.
	EQ.3: Leakage formulas of Graefe, Krummheuer, and Siejak [1990] are used. Blockage is not considered.
	EQ.4: Leakage formulas of Graefe, Krummheuer, and Siejak [1990] are used. Blockage of venting area due to contact is considered.
	EQ.5: Leakage formulas based on flow through a porous media are used. Blockage is not considered.
	EQ.6: Leakage formulas based on flow through a porous media are
	LT.0: FVOPT defines the same fabric venting options as above, but a new formula for the leakage area is used to replace the element area. See Remark 16 .

Note: See [Remark 17](#) for FVOPT option for CPM (*AIRBAG_PARTICLE) bags.

TSRFAC	Strain restoration factor:
	LT.0: TSRFAC is the ID of a curve defining TSRFAC as a function of time.
	GT.0 and LT.1: TSRFAC applied from time 0.
	GE.1: TSRFAC is the ID of a curve that defines TSRFAC as a function of time using an alternate method (not available for FORM = 0 or 1).

This card is included if X0 = 1 and FVOPT ≥ 7.

Card 3e	1	2	3	4	5	6	7	8
Variable	AOPT	FLC	FAC	ELA	LNRC	FORM	FVOPT	TSRFAC
Type	F	F	F	F	F	F	F	F
Remarks		2	2	3	4	11	9	10

VARIABLE	DESCRIPTION
AOPT	<p>Material axes option (see MAT_OPTIONTROPIC_ELASTIC for a more complete description). Also, please refer to Remark 5 for additional information specific to fiber directions for fabrics:</p> <p>EQ.0.0: Locally orthotropic with material axes determined by element nodes 1, 2, and 4, as with *DEFINE_COORDINATE_NODES, and then rotated about the element normal by an angle BETA</p> <p>EQ.2.0: Globally orthotropic with material axes determined by vectors defined below, as with *DEFINE_COORDINATE_VECTOR</p> <p>EQ.3.0: Locally orthotropic material axes determined by rotating the material axes about the element normal by an angle, BETA, from a line in the plane of the element defined by the cross product of the vector \mathbf{v} with the element normal</p> <p>LT.0.0: The absolute value of AOPT is a coordinate system ID number (CID on *DEFINE_COORDINATE_NODES, *DEFINE_COORDINATE_SYSTEM or *DEFINE_COORDINATE_VECTOR). Available in R3 version of 971 and later.</p>
FLC	<p>Optional porous leakage flow coefficient. (See theory manual.)</p> <p>GE.0: Porous leakage flow coefficient.</p> <p>LT.0: FLC is interpreted as a load curve ID defining FLC as a function of the stretching ratio defined as $r_s = A/A_0$. See notes below.</p>
FAC	<p>Optional characteristic fabric parameter. (See theory manual.)</p> <p>GE.0: Characteristic fabric parameter</p> <p>LT.0: FAC is interpreted as a load curve defining leakage volume flux rate versus the pressure ratio defined as $r_p = P_{\text{air}}/P_{\text{bag}}$. See Remark 2 below. The volume flux (per area) rate (per time) has the unit of</p> $d(\text{vol}_{\text{flux}})/dt \approx [\text{length}]^3/([\text{length}]^2[\text{time}])$ $\approx [\text{length}]/[\text{time}],$ <p>equivalent to relative porous gas speed.</p>

VARIABLE	DESCRIPTION
ELA	Effective leakage area for blocked fabric, ELA (see Remark 3): LT.0.0: ELA is the load curve ID of the curve defining ELA as a function of time. The default value of zero assumes that no leakage occurs. A value of .10 would assume that 10% of the blocked fabric is leaking gas.
LNRC	Flag to turn off compression in liner until the reference geometry is reached, that is, the fabric element becomes tensile: EQ.0.0: Off EQ.1.0: On
FORM	Flag to modify membrane formulation for fabric material: EQ.0.0: Default. Least costly and very reliable. EQ.1.0: Invariant local membrane coordinate system EQ.2.0: Green-Lagrange strain formulation EQ.3.0: Large strain with nonorthogonal material angles. See Remark 5 . EQ.4.0: Large strain with nonorthogonal material angles and nonlinear stress strain behavior. Define optional load curve IDs on optional card. EQ.12.0: Enhanced version of formulation 2. See Remark 11 . EQ.13.0: Enhanced version of formulation 3. See Remark 11 . EQ.14.0: Enhanced version of formulation 4. See Remark 11 . EQ.-14.0: Same as formulation 14 but invokes reading of Card 8. See Remark 14 . EQ.24.0: Enhanced version of formulation 14. See Remark 11 .
FVOPT	Fabric venting option. EQ.7: Leakage is based on gas volume outflow versus pressure load curve [Lian, 2000]. Blockage is not considered. Absolute pressure is used in the porous-velocity-versus-pressure load curve, given as FAC in the *MAT_FABRIC card.

VARIABLE

DESCRIPTION

EQ.8: Leakage is based on gas volume outflow versus pressure load curve [Lian 2000]. Blockage of venting or porous area due to contact is considered. Absolute pressure is used in the porous-velocity-versus-pressure load curve, given as FAC in the *MAT_FABRIC card.

Note: See Remark 17 for FVOPT option for CPM (*AIRBAG_PARTICLE) bags.

TSRFAC

Strain restoration factor:

LT.0: |TSRFAC| is the ID of a curve defining TSRFAC as a function of time.

GT.0 and LT.1: TSRFAC applied from time 0.

GE.1: TSRFAC is the ID of a curve that defines TSRFAC as a function of time using an alternate method (not available for FORM = 0 or 1).

Additional card for FVOPT < 0.

Card 4	1	2	3	4	5	6	7	8
Variable	L	R	C1	C2	C3			
Type	F	F	F	F	F			

VARIABLE

DESCRIPTION

- L Dimension of unit cell (length)
- R Radius of yarn (length)
- C1 Pressure coefficient (dependent on unit system)
- C2 Pressure exponent
- C3 Strain coefficient

Card 5	1	2	3	4	5	6	7	8
Variable		RGBRTH	A0REF	A1	A2	A3	X0	X1
Type		F	F	F	F	F	F	F

VARIABLE**DESCRIPTION**

RGBRTH	Material dependent birth time of airbag reference geometry. Non-zero RGBRTH overwrites the birth time defined in the *AIRBAG_REFERENCE_GEOMETRY_BIRTH keyword. RGBRTH also applies to reference geometry defined by *AIRBAG_SHELL_REFERENCE_GEOMETRY.
A0REF	Calculation option of initial area, A_0 , used for airbag porosity leakage calculation. EQ.0.: Default. Use the initial geometry defined in *NODE. EQ.1.: Use the reference geometry defined in *AIRBAG_REFERENCE_GEOMETRY or *AIRBAG_SHELL_REFERENCE_GEOMETRY.
A1, A2, A3	Components of vector a for AOPT = 2
X0, X1	Coefficients of Anagonye and Wang [1999] porosity equation for the leakage area: $A_{\text{leak}} = A_0(X_0 + X_1 r_s + X_2 r_p + X_3 r_s r_p)$ X0.EQ.-1: Compressing seal vent option. The leakage area is evaluated as $A_{\text{leak}} = \max(A_{\text{current}} - A_0, 0)$.

Card 6	1	2	3	4	5	6	7	8
Variable	V1	V2	V3				BETA	ISREFG
Type	F	F	F				F	I

VARIABLE**DESCRIPTION**

V1, V2, V3	Components of vector v for AOPT = 3
BETA	Material angle in degrees for AOPT = 0 and 3, may be overridden on the element card, see *ELEMENT_SHELL_BETA.

VARIABLE**DESCRIPTION**

ISREFG

Initialize stress by *AIRBAG_REFERENCE_GEOMETRY. This option applies only to FORM = 12. Note that *MAT_FABRIC cannot be initialized using a dynain file because *INITIAL_STRESS_SHELL is not applicable to *MAT_FABRIC.

EQ.0.0: Default. Not active.

EQ.1.0: Active

Additional card for FORM = 4, 14, -14, or 24.

Card 7	1	2	3	4	5	6	7	8
Variable	LCA	LCB	LCAB	LCUA	LCUB	LCUAB	RL	
Type	I	I	I	I	I	I	F	

VARIABLE**DESCRIPTION**

LCA

Load curve or table ID. Load curve ID defines the stress as a function of uniaxial strain along the *a*-axis fiber. Table ID defines for each strain rate a load curve representing stress as a function of uniaxial strain along the *a*-axis fiber. The load curve is available for FORM = 4, 14, -14, and 24 while the table is allowed only for FORM = -14. If zero, EA is used. For FORM = 14, -14, and 24, this curve can be defined in both tension and compression; see [Remark 6](#) below.

LCB

Load curve or table ID. Load curve ID defines the stress as a function of uniaxial strain along the *b*-axis fiber. Table ID defines for each strain rate a load curve representing stress as a function of uniaxial strain along the *b*-axis fiber. The load curve is available for FORM = 4, 14, -14, and 24 while the table is allowed only for FORM = -14. If zero, EB is used. For FORM = 14, -14, and 24, this curve can be defined in both tension and compression; see [Remark 6](#) below.

LCAB

Load curve ID for shear stress as a function of shear strain in the *ab*-plane. If zero, GAB is used.

LCUA

Unload/reload curve ID for stress as a function of strain along the *a*-axis fiber. If zero, LCA is used.

VARIABLE	DESCRIPTION
LCUB	Unload/reload curve ID for stress as a function of strain along the <i>b</i> -axis fiber. If zero, LCB is used.
LCUAB	Unload/reload curve ID for shear stress as a function of shear strain in the <i>ab</i> -plane. If zero, LCAB is used.
RL	Optional reloading parameter for FORM = 14 and 24. Values between 0.0 (reloading on unloading curve-default) and 1.0 (reloading on a minimum linear slope between unloading curve and loading curve) are possible.

Additional card for FORM = -14.

Card 8	1	2	3	4	5	6	7	8
Variable	LCAA	LCBB	H	DT		ECOAT	SCOAT	TCOAT
Type	I	I	F	F		F	F	F

VARIABLE	DESCRIPTION
LCAA	Load curve or table ID. Load curve ID defines the stress along the <i>a</i> -axis fiber as a function of biaxial strain. Table ID defines for each directional strain rate a load curve representing stress along the <i>a</i> -axis fiber as a function of biaxial strain. If zero, LCA is used.
LCBB	Load curve or table ID. Load curve ID defines the stress along the <i>b</i> -axis fiber as a function of biaxial strain. Table ID defines for each directional strain rate a load curve representing stress along the <i>b</i> -axis fiber as a function of biaxial strain. If zero, LCB is used.
H	Normalized hysteresis parameter between 0 and 1
DT	Strain rate averaging option: EQ.0.0: Strain rate is evaluated using a running average LT.0.0: Strain rate is evaluated using average of last 11 time steps GT.0.0: Strain rate is averaged over the last DT time units
ECOAT	Young's modulus of coat material; see Remark 14 .
SCOAT	Yield stress of coat material; see Remark 14 .

VARIABLE	DESCRIPTION
TCOAT	Thickness of coat material, may be positive or negative; see Remark 14 .

Remarks:

1. **The Compressive Stress Elimination Option for Airbag Wrinkling.** Setting CSE = 1 switches off compressive stress in the fabric, thereby eliminating wrinkles. Without this “no compression” option, the geometry of the bag’s wrinkles controls the amount of mesh refinement. In eliminating the wrinkles, this feature reduces the number of elements needed to attain an accurate solution.

The no compression option can allow elements to collapse to a line which can lead to elements becoming tangled. The elastic liner option is one way to add some stiffness in compression to prevent this, see [Remark 4](#). Alternatively, when using fabric formulations 14, -14, or 24 (see FORM) tangling can be reduced by defining stress/strain curves that include negative strain and stress values. See [Remark 6](#).

2. **Porosity.** The parameters FLC and FAC are optional for the Wang-Nefske and Hybrid inflation models. It is possible for the airbag to be constructed of multiple fabrics having different values for porosity and permeability. Typically, FLC and FAC must be determined experimentally and their variations in time or with pressure are optional to allow for maximum flexibility.
3. **Effects of Airbag-Structure Interaction on Porosity.** To calculate the leakage of gas through the fabric it is necessary to accurately determine the leakage area. The dynamics of the airbag may cause the leakage area to change during the course of the simulation. In particular, the deformation may change the leakage area, but the leakage area may also decrease when the contact between the airbag and the structure blocks the flow. LS-DYNA can check the interaction of the bag with the structure and split the areas into regions that are blocked and unblocked depending on whether the regions are in or not in contact, respectively. Blockage effects may be controlled with the ELA field.
4. **Elastic Liner.** An optional elastic liner can be defined using EL, PRL and LRA-TIO. The liner is an isotropic layer that acts in both tension and compression. However, setting, LNRC to 1.0 eliminates compressive stress in the liner until both principle stresses are tensile. The compressive stress elimination option, CSE = 1, has no influence on the liner behavior.
5. **Fiber Axes.** For formulations 0, 1, and 2, (see FORM) the *a*-axis and *b*-axis fiber directions *are assumed to be orthogonal* and are completely defined by the material axes option, AOPT = 0, 2, or 3. For FORM = 3, 4, 13, or 14, the fiber directions

are not assumed to be orthogonal and must be specified using the ICOMP = 1 option on *SECTION_SHELL. Offset angles should be input into the B1 and B2 fields used normally for integration points 1 and 2. The a -axis and b -axis directions will then be offset from the a -axis direction as determined by the material axis option, AOPT = 0, 2, or 3.

When reference geometry is defined, the material axes are computed using coordinates from the reference geometry. The material axes are determined by computing the angle between the element system and the material direction.

6. **Stress as a function of Strain Curves.** For formulations (see FORM) 4, 14, -14, and 24, 2nd Piola-Kirchhoff stress as a function of Green's strain curves may be defined for a -axis, b -axis, and shear stresses for loading and also for unloading and reloading. Alternatively, the a -axis and b -axis curves can be input using engineering stress as a function of strain by setting DATYP = -2 on *DEFINE_CURVE.

Additionally, for formulations 14, -14, and 24, the uniaxial loading curves LCA and LCB may be defined for negative values of strain and stress, that is, a straightforward extension of the curves into the compressive region. This is available for modeling the compressive stresses resulting from tight folding of airbags.

The a -axis and b -axis stress follow the curves for the entire defined strain region and if compressive behavior is desired the user should preferably make sure the curve covers all strains of interest. For strains below the first point on the curve, the curve is extrapolated using the stiffness from the constant values, EA or EB.

Shear stress/strain behavior is assumed symmetric and curves should be defined for positive strain only. However, formulations 14, -14, and 24 allow the extending of the curves in the negative strain region to model asymmetric behavior. The asymmetric option cannot be used with a shear stress unload curve. If a load curve is omitted, the stress is calculated from the appropriate constant modulus, EA, EB, or GAB.

7. **Yield Behavior.** When formulations 4, 14, -14, and 24 (see FORM) are used with loading and unloading curves the initial yield strain is set equal to the strain of the first point in the load curve having a stress greater than zero. When the current strain exceeds the yield strain, the stress follows the load curve and the yield strain is updated to the current strain. When unloading occurs, the unload/reload curve is shifted along the x -axis until it intersects the load curve at the current yield strain and then the stress is calculated from the shifted curve. When using unloading curves, compressive stress elimination should be active to prevent the fibers from developing compressive stress during unloading when the strain remains tensile. *To use this option, the unload curve should have a nonnegative second derivative so that the curve will shift right as the yield stress increases.*

In fact, if a shift to the left would be needed, the unload curves is not used and unloading will follow the load curve instead.

If LCUA, LCUB, or LCUAB are input with negative curve ID values, then unloading is handled differently. Instead of shifting the unload curve along the *x*-axis, the curve is stretched in both the *x*-direction and *y*-direction such that the first point remains anchored at (0,0) and the initial intersection point of the curves is moved to the current yield point. This option guarantees the stress remains tensile while the strain is tensile, so compressive stress elimination is not necessary. *To use this option the unload curve should have an initial slope less steep than the load curve and should steepen such that it intersects the load curve at some positive strain value.*

- 8. **Shear Unload-Reload, Fabric Formulation, and LS-DYNA version.** With release 6.0.0 of version 971, LS-DYNA changed the way that unload/reload curves for shear stress-strain relations are interpreted. Let *f* be the shear stress unload-reload curve LCUAB. Then,

$$\sigma_{ab} = c_2 f(c_1 \epsilon_{ab})$$

where the scale factors *c*₁ and *c*₂ depend on the fabric form (see FORM) and version of LS-DYNA.

Fabric form	4		14 and -14		24	
	<i>c</i> ₁	<i>c</i> ₂	<i>c</i> ₁	<i>c</i> ₂	<i>c</i> ₁	<i>c</i> ₂
LS971 R5.1.0 and earlier	2	1	2	1	-	-
LS971 R6.0.0 to R7.0	2	1	1	2	-	-
LS-DYNA R7.1 and later	2	1	1	2	1	1

When switching fabric forms or versions, the curve scale factors SFA and SFO on *DEFINE_CURVE can be used to offset this behavior.

- 9. **Per Material Venting Option.** The FVOPT flag allows an airbag fabric venting equation to be assigned to a material. The anticipated use for this option is to allow a vent to be defined using FVOPT = 1 or 2 for one material and fabric leakage to be defined for using FVOPT = 3, 4, 5, or 6 for other materials. In order to use FVOPT, a venting option must first be defined for the airbag using the OPT parameter on *AIRBAG_WANG_NEFSKE or *AIRBAG_HYBRID. If OPT = 0, then FVOPT is ignored. If OPT is defined and FVOPT is omitted, then FVOPT is set equal to OPT.

10. **TSRFAC Option to Restore Element Strains.** Airbags that use a reference geometry will typically have nonzero strains at the start of the calculation. To prevent such initial strains from prematurely opening an airbag, initial strains are stored and subtracted from the measured strain throughout the calculation.

$$\sigma = f(\epsilon - \epsilon_{\text{initial}})$$

- Fabric formulations 2, 3, and 4 (see FORM) subtract off only the initial tensile strains so these forms are typically used with CSE = 1 and LNRC = 1.
- Fabric formulations 12, 13, 14, -14, and 24 subtract off the total initial strains, so these forms may be used with CSE = 0 or 1 and LNRC = 0 or 1. A side effect of this strain modification is that airbags may not achieve the correct volume when they open. Therefore, the TSRFAC option is implemented to reduce the stored initial strain values over time thereby restoring the total strain which drives the airbag towards the correct volume.

During each cycle, the stored initial strains are scaled by $(1.0 - \text{TSRFAC})$. A small value on the order of 0.0001 is typically sufficient to restore the strains in a few milliseconds of simulation time.

$$\sigma = f(\epsilon - \epsilon_{\text{adjustment}})$$

The adjustment to restore initial strain is then,

$$\epsilon_{\text{adjustment}} = \epsilon_{\text{initial}} \prod_i [1 - \text{TSRFAC}].$$

- a) *Time Dependent TSRFAC.* When $\text{TSRFAC} < 0$, $|\text{TSRFAC}|$ becomes the ID of a curve that defines TSRFAC as a function of time. To delay the effect of TSRFAC, the curve ordinate value should be initially zero and should ramp up to a small number to restore the strain at an appropriate time during the simulation. The adjustment to restore initial strain is then,

$$\epsilon_{\text{adjustment}}(t_i) = \epsilon_{\text{initial}} \prod_i [1 - \text{TSRFAC}(t_i)].$$

To prevent airbags from opening prematurely, it is recommended to use the load curve option of TSRFAC to delay the strain restoration until the airbag is partially opened due to pressure loading.

- b) *Alternate Time Dependent TSRFAC.* For fabric formulations 2 and higher, a second curve option is invoked by setting $\text{TSRFAC} \geq 1$ where TSRFAC is again the ID of a curve that defines TSRFAC as a function of time. Like the first curve option, the stored initial strain values are scaled by $(1.0 - \text{TSRFAC})$, but the modified initial strains are not saved, so the effect of TSRFAC does not accumulate. In this case the adjustment to eliminate initial strain

$$\epsilon_{\text{adjustment}}(t_i) = [1 - \text{TSRFAC}(t_i)]\epsilon_{\text{initial}}.$$

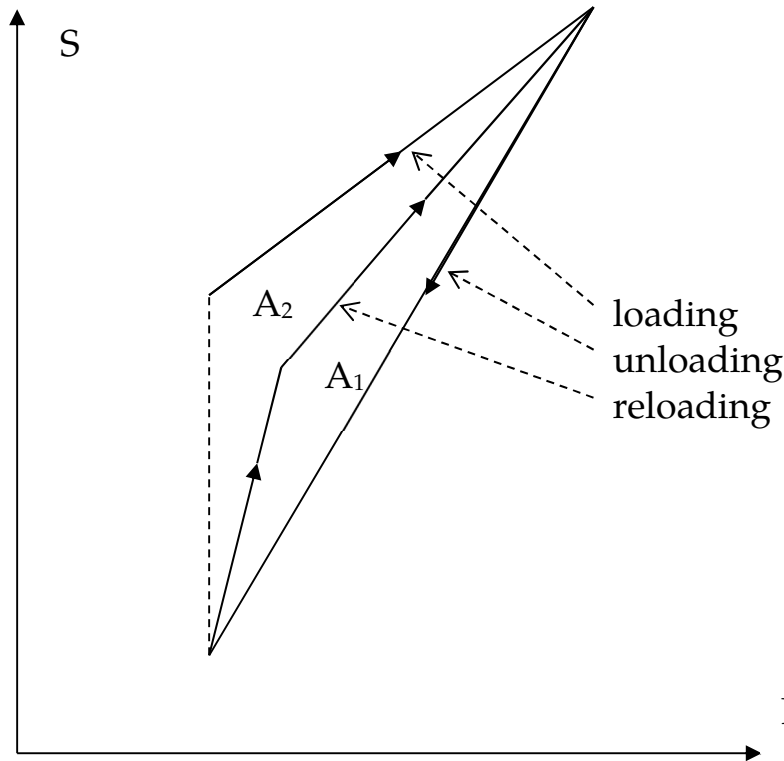

Figure M34-1.

Therefore, the curve should ramp up from zero to one to fully restore the strain. This option gives the user better control of the rate of restoring the strain as it is a function of time rather than solution time step.

- 11. **Enhancements to the Material Formulations.** Material formulations (see FORM) 12, 13, and 14 are enhanced versions of formulations 2, 3, and 4, respectively. The most notable difference in their behavior is apparent when a reference geometry is used for the fabric. As discussed in Remark 10, the strain is modified to prevent initial strains from prematurely opening an airbag at the start of a calculation.

Formulations 2, 3, and 4 subtract the initial tensile strains, while the enhanced formulations subtract the total initial strains. Therefore, the enhanced formulations can be used without setting CSE = 1 and LNRC = 1 since compressive stress cutoff is not needed to prevent initial airbag movement. Formulations 2, 3, and 4 need compressive stress cutoff when used with a reference geometry or they can generate compressive stress at the start of a calculation. Available for formulation 12 only, the ISREFG parameter activates an option to calculate the initial stress by using a reference geometry.

Material formulation 24 is an enhanced version of formulation 14 implementing a correction for Poisson's effects when stress as a function of strain curves are input for the *a*-fiber or *b*-fiber. Also, for formulation 24, the outputted stress and strain in the elout or d3plot database files is engineering stress and strain rather

than the 2nd Piola Kirchoff and Green's strain used by formulations other than 0 and 1.

12. **Noise Reduction for the Strain Rate Measure.** If tables are used, then the strain rate measure is the time derivative of the Green-Lagrange strain in the direction of interest. To suppress noise, the strain rate is averaged according to the value of DT. If DT > 0, it is recommended to use a large enough value to suppress the noise, while being small enough to not lose important information in the signal.
13. **Hysteresis.** The hysteresis parameter H defines the fraction of dissipated energy during a load cycle in terms of the maximum possible dissipated energy. Referring to the [Figure M34-1](#),

$$H \approx \frac{A_1}{A_1 + A_2} .$$

14. **Coating Feature for Additional Rotational Resistance.** It is possible to model coating of the fabric using a sheet of elastic-ideal-plastic material where the Young's modulus, yield stress and thickness is specified for the coat material. This will add rotational resistance to the fabric for a more realistic behavior of coated fabrics. To read these properties set FORM = -14, which adds an extra card containing the three fields ECOAT, SCOAT and TCOAT, corresponding to the three coat material properties mentioned above.

The thickness, TCOAT, applies to both sides of the fabric. The coat material for a certain fabric element deforms along with this and all elements connected to this element, which is how the rotations are "captured." Note that unless TCOAT is set to a negative value, the coating will add to the membrane stiffness. For negative values of TCOAT the thickness is set to |TCOAT| and the membrane contribution from the coating is suppressed. For this feature to work, the fabric parts must not include any T-intersections, and all of the surface normal vectors of connected fabric elements must point in the same direction. This option increases the computational complexity of this material.

15. **Poisson's Ratios.** Fabric forms 12, 13, 14, -14, and 24 allow input of both the minor Poisson's ratio, ν_{ba} , and the major Poisson's ratio, ν_{ab} . This allows asymmetric Poisson's behavior to be modelled. If the major Poisson's ratio is left blank or input as zero, then it will be calculated using $\nu_{ab} = \nu_{ba} \frac{E_a}{E_b}$.
16. **St. Venant-Wantzel Leakage.** If a negative value for the fabric venting option FVOPT is used (only -1 and -2 are supported), the mass flux through a fabric membrane is calculated according St.Venant-Wantzel by

$$\dot{m} = A_{\text{eff}} \Psi \sqrt{2p_i \rho_i}$$

where p_i describes the internal pressure, ρ_i is the density of the outlet gas, and the effluence function ψ depends on the character of the flow, the adiabatic exponent κ and the pressure difference between the inside (p_i) and the outside (p_a) of the membrane. For subsonic flow it is formulated as:

$$\Psi = \sqrt{\frac{\kappa}{\kappa - 1} \left[\left(\frac{p_a}{p_i} \right)^{\frac{2}{\kappa}} - \left(\frac{p_a}{p_i} \right)^{\frac{\kappa+1}{\kappa}} \right]}$$

and for sonic or critical flow as:

$$\Psi = \sqrt{\frac{\kappa}{2} \left(\frac{2}{\kappa + 1} \right)^{\frac{\kappa+1}{\kappa-1}}}$$

The effective venting area of the membrane is determined according to M. Schlenger:

$$A_{eff} = \frac{A_0}{L^2} \left[(C_1 \Delta p^{C_2}) (L - 2r)^2 + C_3 \left(L\lambda_1 - \frac{2r}{\sqrt{\lambda_2}} \right) \left(L\lambda_2 - \frac{2r}{\sqrt{\lambda_1}} \right) \right] \sin(\alpha_{12})$$

where λ_i is the stretch in fiber direction i and α_{12} is the angle between the fibers. The initial membrane area is equal to A_0 . r and L represent the radius of the fabric fiber and the edge length of the fabric set, respectively. The coefficients, L , r , C_1 , C_2 , and C_3 , must be defined on additional Card 4. This option is supported for *AIRBAG_WANG_NESFKE, *AIRBAG_HYBRID, and *AIRBAG_PARTICLE. No additional input in *AIRBAG cards is needed. All FORM options are supported, whereas α_{12} can only be different from 90 degree for FORM = 3, 4, 13, or 14.

17. **CPM (*AIRBAG_PARTICLE) Bags.** Only FVOPT = -1, -2, 7, and 8 are supported for CPM bags. If FVOPT = 0 is used, it defaults to FVOPT = 8. For FVOPT = -1 and -2, FLC is active and can be either a scalar or a curve defining the porous leakage flow coefficient as a function of time. The FAC coefficient, however, is *inactive* as the porous leakage velocity is computed using the formula specified in [Remark 16](#) from the coefficient defined in Card 4. Note that for uniform pressure airbags (*AIRBAG_HYBRID_...) *both* the FLC and FAC coefficients are active.

*MAT_FABRIC_MAP

This is Material Type 34 in which the stress response is given exclusively by tables, or maps, and where some obsolete features in *MAT_FABRIC have been deliberately excluded to allow for a clean input and better overview of the model.

Card Summary:

Card 1. This card is required.

MID	RO	PXX	PYY	SXY	DAMP	TH	
-----	----	-----	-----	-----	------	----	--

Card 2a. This card is included if and only if $0 < X0 < 1$.

FVOPT	X0	X1	X2	X3	ELA		
-------	----	----	----	----	-----	--	--

Card 2b. This card is included if and only if $X0 = 0$ or $X0 = -1$ and $FVOPT < 7$.

FVOPT	X0	X1	FLC	FAC	ELA		
-------	----	----	-----	-----	-----	--	--

Card 2c. This card is included if and only if $X0 = 0$ or $X0 = -1$ and $FVOPT \geq 7$.

FVOPT	X0	X1	FLC	FAC	ELA		
-------	----	----	-----	-----	-----	--	--

Card 2d. This card is included if and only if $X0 = 1$ and $FVOPT < 7$.

FVOPT	X0	X1	FLC	FAC	ELA		
-------	----	----	-----	-----	-----	--	--

Card 2e. This card is included if and only if $X0 = 1$ and $FVOPT \geq 7$.

FVOPT	X0	X1	FLC	FAC	ELA		
-------	----	----	-----	-----	-----	--	--

Card 3. This card is required.

ISREFG	CSE	SRFAC	BULKC	JACC	FXX	FYY	DT
--------	-----	-------	-------	------	-----	-----	----

Card 4. This card is required.

AOPT	ECOAT	SCOAT	TCOAT				
------	-------	-------	-------	--	--	--	--

Card 5. This card is required.

XP	YP	ZP	A1	A2	A3		
----	----	----	----	----	----	--	--

Card 6. This card is required.

V1	V2	V3	D1	D2	D3	BETA	
----	----	----	----	----	----	------	--

Data Card Definitions:

Card 1	1	2	3	4	5	6	7	8
Variable	MID	RO	PXX	PYY	SXY	DAMP	TH	
Type	A	F	F	F	F	F	F	

VARIABLE

DESCRIPTION

MID	Material identification. A unique number or label must be specified (see *PART).
RO	Mass density
PXX	Table giving engineering local XX-stress as function of engineering local XX-strain and YY-strain
PYY	Table giving engineering local YY-stress as function of engineering local YY-strain and XX-strain
SXY	Curve giving local 2 nd Piola-Kirchhoff XY-stress as function of local Green XY-strain.
DAMP	Damping coefficient for numerical stability
TH	Table giving hysteresis factor $0 \leq H < 1$ as function of engineering local XX-strain and YY-strain: GT.0.0: TH is table ID. LE.0.0: -TH is used as constant value for hysteresis factor.

This card is included if and only if $0 < X0 < 1$.

Card 2a	1	2	3	4	5	6	7	8
Variable	FVOPT	X0	X1	X2	X3	ELA		
Type	F	F	F	F	F	F		

VARIABLE	DESCRIPTION
FVOPT	<p>Fabric venting option (see *MAT_FABRIC):</p> <p>EQ.1: Wang-Nefske formulas for venting through an orifice are used. Blockage is not considered.</p> <p>EQ.2: Wang-Nefske formulas for venting through an orifice are used. Blockage of venting area due to contact is considered.</p> <p>EQ.3: Leakage formulas of Graefe, Krummheuer, and Siejak [1990] are used. Blockage is not considered.</p> <p>EQ.4: Leakage formulas of Graefe, Krummheuer, and Siejak [1990] are used. Blockage of venting area due to contact is considered.</p> <p>EQ.5: Leakage formulas based on flow through a porous media are used. Blockage is not considered.</p> <p>EQ.6: Leakage formulas based on flow through a porous media are used. Blockage of venting area due to contact is considered.</p> <p>EQ.7: Leakage is based on gas volume outflow versus pressure load curve [Lian, 2000]. Blockage is not considered. Absolute pressure is used in the porous-velocity-versus-pressure load curve, given as FAC.</p> <p>EQ.8: Leakage is based on gas volume outflow versus pressure load curve [Lian 2000]. Blockage of venting or porous area due to contact is considered. Absolute pressure is used in the porous-velocity-versus-pressure load curve, given as FAC.</p> <p>LT.0: FVOPT defines the same fabric venting options as above, but a new formula for the leakage area is used to replace the element area. See Remark 16 of *MAT_FABRIC.</p>
Note: See Remark 17 of *MAT_FABRIC for FVOPT option for CPM (*AIRBAG_PARTICLE) bags.	
X0, X1	Coefficients of Anagonye and Wang [1999] porosity equation for the leakage area: $A_{\text{leak}} = A_0(X_0 + X_1 r_s + X_2 r_p + X_3 r_s r_p)$; see *MAT_FABRIC.
X2	Coefficient of the porosity from the equation in Anagonye and Wang [1999]
X3	Coefficient of the porosity equation of Anagonye and Wang [1999]

<u>VARIABLE</u>	<u>DESCRIPTION</u>
-----------------	--------------------

ELA	<p>Effective leakage area for blocked fabric, ELA (see Remark 3 of *MAT_FABRIC):</p> <p>LT.0.0: ELA is the load curve ID of the curve defining ELA as a function of time. The default value of zero assumes that no leakage occurs. A value of .10 would assume that 10% of the blocked fabric is leaking gas.</p>
-----	--

This card is included if and only if X0 = 0 or X0 = -1 and FVOPT < 7.

Card 2b	1	2	3	4	5	6	7	8
Variable	FVOPT	X0	X1	FLC	FAC	ELA		
Type	F	F	F	F	F	F		

<u>VARIABLE</u>	<u>DESCRIPTION</u>
-----------------	--------------------

FVOPT	<p>Fabric venting option (see *MAT_FABRIC):</p> <p>EQ.1: Wang-Nefske formulas for venting through an orifice are used. Blockage is not considered.</p> <p>EQ.2: Wang-Nefske formulas for venting through an orifice are used. Blockage of venting area due to contact is considered.</p> <p>EQ.3: Leakage formulas of Graefe, Krummheuer, and Siejak [1990] are used. Blockage is not considered.</p> <p>EQ.4: Leakage formulas of Graefe, Krummheuer, and Siejak [1990] are used. Blockage of venting area due to contact is considered.</p> <p>EQ.5: Leakage formulas based on flow through a porous media are used. Blockage is not considered.</p> <p>EQ.6: Leakage formulas based on flow through a porous media are used. Blockage of venting area due to contact is considered.</p> <p>LT.0: FVOPT defines the same fabric venting options as above, but a new formula for the leakage area is used to replace the element area. See Remark 16 of *MAT_FABRIC.</p>
-------	---

Note: See [Remark 17](#) of *MAT_FABRIC for FVOPT option for CPM (*AIRBAG_PARTICLE) bags.

VARIABLE	DESCRIPTION
X0, X1	<p>Coefficients of Anagonye and Wang [1999] porosity equation for the leakage area: $A_{leak} = A_0(X_0 + X_1r_s + X_2r_p + X_3r_s r_p)$; see *MAT_FABRIC.</p> <p>X0.EQ.-1: Compressing seal vent option. The leakage area is evaluated as $A_{leak} = \max(A_{current} - A_0, 0)$.</p>
FLC	<p>Optional porous leakage flow coefficient. (See theory manual.)</p> <p>GE.0: Porous leakage flow coefficient.</p> <p>LT.0: FLC is interpreted as a load curve ID defining FLC as a function of time.</p>
FAC	<p>Optional characteristic fabric parameter. (See theory manual.)</p> <p>GE.0: Characteristic fabric parameter</p> <p>LT.0: FAC is interpreted as a load curve ID defining FAC as a function of absolute pressure.</p>
ELA	<p>Effective leakage area for blocked fabric, ELA (see Remark 3 of *MAT_FABRIC):</p> <p>LT.0.0: ELA is the load curve ID of the curve defining ELA as a function of time. The default value of zero assumes that no leakage occurs. A value of .10 would assume that 10% of the blocked fabric is leaking gas.</p>

This card is included if and only if $X0 = 0$ or $X0 = -1$ and $FVOPT \geq 7$.

Card 2c	1	2	3	4	5	6	7	8
Variable	FVOPT	X0	X1	FLC	FAC	ELA		
Type	F	F	F	F	F	F		

VARIABLE	DESCRIPTION
FVOPT	<p>Fabric venting option (see *MAT_FABRIC):</p> <p>EQ.7: Leakage is based on gas volume outflow versus pressure load curve [Lian, 2000]. Blockage is not considered. Absolute pressure is used in the porous-velocity-versus-pressure load curve, given as FAC.</p>

VARIABLE	DESCRIPTION
	<p>EQ.8: Leakage is based on gas volume outflow versus pressure load curve [Lian 2000]. Blockage of venting or porous area due to contact is considered. Absolute pressure is used in the porous-velocity-versus-pressure load curve, given as FAC.</p> <p>Note: See Remark 17 of *MAT_FABRIC for FVOPT option for CPM (*AIRBAG_PARTICLE) bags.</p>
X0, X1	<p>Coefficients of Anagonye and Wang [1999] porosity equation for the leakage area: $A_{leak} = A_0(X_0 + X_1r_s + X_2r_p + X_3r_sr_p)$; see *MAT_FABRIC.</p> <p>X0.EQ.-1: Compressing seal vent option. The leakage area is evaluated as $A_{leak} = \max(A_{current} - A_0, 0)$.</p>
FLC	<p>Optional porous leakage flow coefficient. (See theory manual.)</p> <p>GE.0: Porous leakage flow coefficient</p> <p>LT.0: FLC is interpreted as a load curve ID defining FLC as a function of time.</p>
FAC	<p>Optional characteristic fabric parameter. (See theory manual.)</p> <p>GE.0: Characteristic fabric parameter</p> <p>LT.0: FAC is interpreted as a load curve ID giving leakage volume flux rate as a function of absolute pressure. The volume flux (per area) rate (per time) has the dimensions of</p> $d(\text{vol}_{flux})/dt \approx [\text{length}]^3/([\text{length}]^2[\text{time}])$ $\approx [\text{length}]/[\text{time}],$ <p>equivalent to relative porous gas speed.</p>
ELA	<p>Effective leakage area for blocked fabric, ELA (see Remark 3 of *MAT_FABRIC):</p> <p>LT.0.0: ELA is the load curve ID of the curve defining ELA as a function of time. The default value of zero assumes that no leakage occurs. A value of .10 would assume that 10% of the blocked fabric is leaking gas.</p>

This card is included if and only if $X_0 = 1$ and $FVOPT < 7$.

Card 2d	1	2	3	4	5	6	7	8
Variable	FVOPT	X0	X1	FLC	FAC	ELA		
Type	F	F	F	F	F	F		

VARIABLE**DESCRIPTION**

FVOPT

Fabric venting option (see *MAT_FABRIC):

EQ.1: Wang-Nefske formulas for venting through an orifice are used. Blockage is not considered.

EQ.2: Wang-Nefske formulas for venting through an orifice are used. Blockage of venting area due to contact is considered.

EQ.3: Leakage formulas of Graefe, Krummheuer, and Siejak [1990] are used. Blockage is not considered.

EQ.4: Leakage formulas of Graefe, Krummheuer, and Siejak [1990] are used. Blockage of venting area due to contact is considered.

EQ.5: Leakage formulas based on flow through a porous media are used. Blockage is not considered.

EQ.6: Leakage formulas based on flow through a porous media are used. Blockage of venting area due to contact is considered.

LT.0: |FVOPT| defines the same fabric venting options as above, but a new formula for the leakage area is used to replace the element area. See [Remark 16](#) of *MAT_FABRIC.

Note: See [Remark 17](#) of *MAT_FABRIC for FVOPT option for CPM (*AIRBAG_PARTICLE) bags.

X0, X1

Coefficients of Anagonye and Wang [1999] porosity equation for the leakage area: $A_{\text{leak}} = A_0(X_0 + X_1 r_s + X_2 r_p + X_3 r_s r_p)$; see *MAT_FABRIC.

FLC

Optional porous leakage flow coefficient. (See theory manual and *MAT_FABRIC.)

GE.0: Porous leakage flow coefficient.

<u>VARIABLE</u>	<u>DESCRIPTION</u>
	LT.0: FLC is interpreted as a load curve ID defining FLC as a function of the stretching ratio defined as $r_s = A/A_0$.
FAC	Optional characteristic fabric parameter. (See theory manual and *MAT_FABRIC.) GE.0: Characteristic fabric parameter LT.0: FAC is interpreted as a load curve defining FAC as a function of the pressure ratio $r_p = P_{air}/P_{bag}$.
ELA	Effective leakage area for blocked fabric, ELA (see Remark 3 of *MAT_FABRIC): LT.0.0: ELA is the load curve ID of the curve defining ELA as a function of time. The default value of zero assumes that no leakage occurs. A value of .10 would assume that 10% of the blocked fabric is leaking gas.

This card is included if and only if $X0 = 1$ and $FVOPT \geq 7$.

Card 2e	1	2	3	4	5	6	7	8
Variable	FVOPT	X0	X1	FLC	FAC	ELA		
Type	F	F	F	F	F	F		

<u>VARIABLE</u>	<u>DESCRIPTION</u>
FVOPT	Fabric venting option (see *MAT_FABRIC): EQ.7: Leakage is based on gas volume outflow versus pressure load curve [Lian, 2000]. Blockage is not considered. Absolute pressure is used in the porous-velocity-versus-pressure load curve, given as FAC. EQ.8: Leakage is based on gas volume outflow versus pressure load curve [Lian 2000]. Blockage of venting or porous area due to contact is considered. Absolute pressure is used in the porous-velocity-versus-pressure load curve, given as FAC. Note: See Remark 17 of *MAT_FABRIC for FVOPT option for CPM (*AIRBAG_PARTICLE) bags.

VARIABLE	DESCRIPTION
----------	-------------

X0, X1	Coefficients of Anagonye and Wang [1999] porosity equation for the leakage area: $A_{leak} = A_0(X_0 + X_1r_s + X_2r_p + X_3r_s r_p)$; see *MAT_FABRIC.
--------	--

FLC	Optional porous leakage flow coefficient. (See theory manual.) GE.0: Porous leakage flow coefficient. LT.0: FLC is interpreted as a load curve ID defining FLC as a function of the stretching ratio defined as $r_s = A/A_0$.
-----	---

FAC	Optional characteristic fabric parameter. (See theory manual.) GE.0: Characteristic fabric parameter LT.0: FAC is interpreted as a load curve defining leakage volume flux rate versus the pressure ratio defined as $r_p = P_{air}/P_{bag}$. The volume flux (per area) rate (per time) has the unit of
-----	---

$$d(\text{vol}_{flux})/dt \approx [\text{length}]^3/([\text{length}]^2[\text{time}])$$

$$\approx [\text{length}]/[\text{time}],$$

equivalent to relative porous gas speed.

ELA	Effective leakage area for blocked fabric, ELA (see Remark 3 of *MAT_FABRIC):
-----	---

LT.0.0: |ELA| is the load curve ID of the curve defining ELA as a function of time. The default value of zero assumes that no leakage occurs. A value of .10 would assume that 10% of the blocked fabric is leaking gas.

Card 3	1	2	3	4	5	6	7	8
Variable	ISREFG	CSE	SRFAC	BULKC	JACC	FXX	FYY	DT
Type	F	F	F	F	F	F	F	F

VARIABLE	DESCRIPTION
----------	-------------

ISREFG	Initial stress by reference geometry: EQ.0.0: Not active
--------	---

VARIABLE	DESCRIPTION
	EQ.1.0: Active
CSE	Compressive stress elimination option: EQ.0.0: Do not eliminate compressive stresses. EQ.1.0: Eliminate compressive stresses.
SRFAC	Load curve ID for smooth stress initialization when using a reference geometry
BULKC	Bulk modulus for fabric compaction
JACC	Jacobian for the onset of fabric compaction
FXX	Load curve giving scale factor of uniaxial stress in first material direction as function of engineering strain rate
FYY	Load curve giving scale factor of uniaxial stress in second material direction as function of engineering strain rate
DT	Time window for smoothing strain rates used for FXX and FYY

Card 4	1	2	3	4	5	6	7	8
Variable	AOPT	ECOAT	SCOAT	TCOAT				
Type	F	F	F	F				

VARIABLE	DESCRIPTION
AOPT	Material axes option (see MAT_OPTIONTROPIC_ELASTIC for a more complete description). Also, please refer to Remark 5 of *MAT_FABRIC for additional information specific to fiber directions for fabrics: EQ.0.0: Locally orthotropic with material axes determined by element nodes 1, 2, and 4, as with *DEFINE_COORDINATE_NODES, and then rotated about the element normal by an angle BETA EQ.2.0: Globally orthotropic with material axes determined by vectors defined below, as with *DEFINE_COORDINATE_VECTOR

<u>VARIABLE</u>	<u>DESCRIPTION</u>
-----------------	--------------------

EQ.3.0: Locally orthotropic material axes determined by rotating the material axes about the element normal by an angle, BETA, from a line in the plane of the element defined by the cross product of the vector **v** with the element normal

LT.0.0: The absolute value of AOPT is a coordinate system ID number (CID on *DEFINE_COORDINATE_NODES, *DEFINE_COORDINATE_SYSTEM or *DEFINE_COORDINATE_VECTOR). Available in R3 version of 971 and later.

ECOAT Young's modulus of coat material to include bending properties. This together with the following two parameters (SCOAT and TCOAT) encompass the same coating/bending feature as in *MAT_FABRIC. Please refer to these manual pages and associated remarks.

SCOAT Yield stress of coat material, see *MAT_FABRIC.

TCOAT Thickness of coat material, may be positive or negative, see *MAT_FABRIC.

Card 5	1	2	3	4	5	6	7	8
Variable				A1	A2	A3		
Type				F	F	F		

<u>VARIABLE</u>	<u>DESCRIPTION</u>
-----------------	--------------------

A1, A2, A3 Components of vector **a** for AOPT = 2

Card 6	1	2	3	4	5	6	7	8
Variable	V1	V2	V3	D1	D2	D3	BETA	
Type	F	F	F	F	F	F	F	

VARIABLE	DESCRIPTION
V1, V2, V3	Components of vector v for AOPT = 3
D1, D2, D3	Components of vector d for AOPT = 2
BETA	Material angle in degrees for AOPT = 0 and 3. It may be overridden on the element card; see *ELEMENT_SHELL_BETA.

Remarks:

- Material Model.** This material model invokes a special membrane element formulation regardless of the element choice. It is an anisotropic hyperelastic model where the 2nd Piola-Kirchhoff stress **S** is a function of the Green-Lagrange strain **E** and possibly its history. Due to anisotropy, this strain is transformed to obtain the strains in each of the fiber directions, E_{XX} and E_{YY} , together with the shear strain, E_{XY} . The associated stress components in the local system are given as functions of the strain components

$$\begin{aligned}
 S_{XX} &= \gamma S_{XX}(E_{XX}, E_{YY}) \vartheta \\
 S_{YY} &= \gamma S_{YY}(E_{YY}, E_{XX}) \vartheta \\
 S_{XY} &= \gamma S_{XY}(E_{XY}) \vartheta
 \end{aligned}$$

The factor γ is used for dissipative effects and is described in more detail in [Remark 4](#). For TH = 0, $\gamma = 1$. The function ϑ represents a strain rate scale factor (see [Remark 6](#)); for FXX = FYY = 0 this factor is 1. While the shear relation is given directly in the input through the curve SXY, the tabular input of the fiber stress components PXX and PYY is for the sake of convenience. PXX and PYY give the engineering stress as function of engineering strain, that is,

$$\begin{aligned}
 P_{XX} &= P_{XX}(e_{XX}, e_{YY}) \\
 P_{YY} &= P_{YY}(e_{YY}, e_{XX})
 \end{aligned}$$

Because of this, the following conversion formulae are used between stresses and strains

$$\begin{aligned}
 e &= \sqrt{1 + 2E} - 1 \\
 S &= \frac{P}{1 + e}
 \end{aligned}$$

which are applied in each of the two fiber directions.

- Compressive Stress Elimination.** Compressive stress elimination is optional through the CSE parameter, and when activated the principal components of the 2nd Piola-Kirchhoff stress is restricted to positive values.

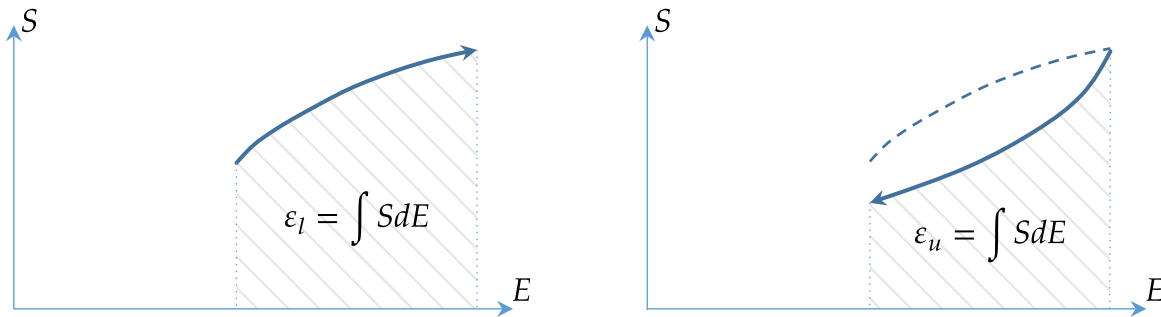

Figure M34M-1. Cyclic loading model for hysteresis model H

3. **Reference Geometry and Smooth Stress Initialization.** If a reference geometry is used, then SRFAC is the curve ID for a function $\alpha(t)$ that should increase from zero to unity during a short time span. During this time span, the Green-Lagrange strain used in the formulae in Remark 1 above is substituted with

$$\tilde{\mathbf{E}} = \mathbf{E} - [1 - \alpha(t)]\mathbf{E}_0,$$

where \mathbf{E}_0 is the strain at time zero. This is done in order to smoothly initialize the stress resulting from using a reference geometry different from the geometry at time zero.

4. **Dissipative Effects.** The factor γ is a function of the strain history and is initially set to unity. It depends, more specifically, on the internal work ϵ given by the stress power

$$\dot{\epsilon} = \mathbf{S} : \dot{\mathbf{E}}.$$

The evolution of γ is related to the stress power since it will increase on loading and decrease on unloading, and as a result it introduces dissipation. The exact mathematical formula is too complicated to reveal, but basically the function looks like

$$\gamma = \begin{cases} 1 - H(\bar{e}_{XX}, \bar{e}_{YY}) + H(\bar{e}_{XX}, \bar{e}_{YY}) \exp[\beta(\epsilon - \bar{\epsilon})] & \dot{\epsilon} < 0 \\ 1 - H(\bar{e}_{XX}, \bar{e}_{YY}) \exp[-\beta(\epsilon - \underline{\epsilon})] & \dot{\epsilon} \geq 0 \end{cases}$$

Here $\bar{\epsilon}$ is the maximum attained internal work up to this point in time, \bar{e}_{XX} and \bar{e}_{YY} are the engineering strain values associated with value. $H(\bar{e}_{XX}, \bar{e}_{YY})$ is the hysteresis factor defined by the user through the input parameter TH; it may or may not depend on the strains. β is a decay constant that depends on \bar{e}_{XX} and \bar{e}_{YY} , and $\underline{\epsilon}$ is the minimum attained internal work at any point in time after $\bar{\epsilon}$ was attained. In other words, on unloading γ will exponentially decay to $1 - H$, and on loading it will exponentially grow to 1 and always be restricted by the lower and upper bounds, $1 - H < \gamma \leq 1$. The only thing the user needs to care about is to input a proper hysteresis factor H , and with reference to a general loading/unloading cycle illustrated in Figure M34M-1 the relation $1 - H = \epsilon_u / \epsilon_l$ should hold.

5. **Packing of Yarn in Compression.** To account for the packing of yarns in compression, a compaction effect is modeled by adding a term to the strain energy function of the form

$$W_c = K_c J \left\{ \ln \left(\frac{J}{J_c} \right) - 1 \right\}, \text{ for } J \leq J_c .$$

Here K_c (BULKC) is a physical bulk modulus, $J = \det(\mathbf{F})$ is the jacobian of the deformation and J_c (JACC) is the critical jacobian for when the effect commences. \mathbf{F} is the deformation gradient. This contributes to the pressure with a term

$$p = K_c \ln \left(\frac{J_c}{J} \right), \text{ for } J \leq J_c$$

and thus prevents membrane elements from collapsing or inverting when subjected to compressive loads. The bulk modulus K_c should be selected with the slopes in the stress map tables in mind, presumably some order of magnitude(s) smaller.

6. **Strain Rate Scale Factor.** As an option, the local membrane stress can be scaled based on the engineering strain rates via the function $\vartheta = \vartheta(\dot{\epsilon}, \mathbf{S})$. We set

$$\dot{\epsilon} = \max \left(\frac{\dot{\epsilon}}{\|\mathbf{FS}\|}, 0 \right)$$

to be the equivalent engineering strain rate in the direction of loading and define

$$\vartheta(\dot{\epsilon}, \mathbf{S}) = \frac{F_{XX}(\dot{\epsilon})|S_{XX}| + F_{YY}(\dot{\epsilon})|S_{YY}| + 2|S_{XY}|}{|S_{XX}| + |S_{YY}| + 2|S_{XY}|},$$

meaning that the strain rate scale factor defaults to the user input data FXX and FYY for uniaxial loading in the two material directions, respectively. Note that we only consider strain rate scaling in loading and not in unloading, and furthermore that the strain rates used in evaluating the curves are pre-filtered using the time window DT to avoid excessive numerical noise. It is, therefore, recommended to set DT to a time corresponding to at least hundred time steps or so.

***MAT_PLASTIC_GREEN-NAGHDI_RATE**

This is Material Type 35. It is similar to model 3 but uses the Green-Naghdi Rate formulation rather than the Jaumann rate for the stress update. For some cases this might be helpful. This model also has a strain rate dependency following the Cowper-Symonds model. It is available for solid, thick shell (formulations 3, 5, and 7), and SPH elements.

Card 1	1	2	3	4	5	6	7	8
Variable	MID	RO	E	PR				
Type	A	F	F	F				

Card 2	1	2	3	4	5	6	7	8
Variable	SIGY	ETAN	SRC	SRP	BETA			
Type	F	F	F	F	F			

VARIABLE**DESCRIPTION**

MID	Material identification. A unique number or label must be specified (see *PART).
RO	Density
E	Young's modulus
PR	Poisson's ratio
SIGY	Yield stress
ETAN	Plastic hardening modulus
SRC	Strain rate parameter, C
SRP	Strain rate parameter, p
BETA	Hardening parameter, $0 < \beta' < 1$

***MAT_3-PARAMETER_BARLAT_{OPTION}**

This is Material Type 36. This model was developed by Barlat and Lian [1989] for modeling sheets with anisotropic materials under plane stress conditions. Lankford parameters may be used to define the anisotropy. This particular development is due to Barlat and Lian [1989]. *MAT_FLD_3-PARAMETER_BARLAT is a version of this material model that includes a flow limit diagram failure option.

Available options include:

<BLANK>

NLP

The NLP option estimates failure using the Formability Index (F.I.), which accounts for the non-linear strain paths seen in metal forming applications (see the [Remarks](#)). The NLP field in Card 4b *must* be defined when using this option. The NLP option is also available for *MAT_037, *MAT_125, and *MAT_226.

Card Summary:

Card 1. This card is required.

MID	RO	E	PR	HR	P1	P2	ITER
-----	----	---	----	----	----	----	------

Card 2a. This card is included if PB = 0 (see Card 4a/4b).

M	R00	R45	R90	LCID	E0	SPI	P3
---	-----	-----	-----	------	----	-----	----

Card 2b. This card is included if PB > 0. (see Card 4a/4b).

M	AB	CB	HB	LCID	E0	SPI	P3
---	----	----	----	------	----	-----	----

Card 3. This card is included if M < 0.

CRC1	CRA1	CRC2	CRA2	CRC3	CRA3	CRC4	CRA4
------	------	------	------	------	------	------	------

Card 4a. This card is included if the keyword option is unset (<BLANK>).

AOPT	C	P	VLCID		PB	HTA	HTB
------	---	---	-------	--	----	-----	-----

Card 4b. This card is included if the keyword option is NLP.

AOPT	C	P	VLCID		PB	NLP	
------	---	---	-------	--	----	-----	--

Card 5. This card is required.

			A1	A2	A3	HTC	HTD
--	--	--	----	----	----	-----	-----

Card 6. This card is required.

V1	V2	V3	D1	D2	D3	BETA	HTFLAG
----	----	----	----	----	----	------	--------

Card 7. This card is optional.

USRFAIL	LCBI	LCSH					
---------	------	------	--	--	--	--	--

Data Card Definitions:

Card 1	1	2	3	4	5	6	7	8
Variable	MID	RO	E	PR	HR	P1	P2	ITER
Type	A	F	F	F	F	F	F	F

VARIABLE

DESCRIPTION

MID	Material identification. A unique number or label must be specified (see *PART).
RO	Mass density
E	Young's modulus, E GT.0.0: constant value LT.0.0: load curve ID = E , which defines Young's Modulus as a function of plastic strain. See Remarks .
PR	Poisson's ratio, ν
HR	Hardening rule: EQ.1.0: linear (default) EQ.2.0: exponential (Swift) EQ.3.0: load curve or table with strain rate effects EQ.4.0: exponential (Voce) EQ.5.0: exponential (Gosh)

VARIABLE	DESCRIPTION
	EQ.6.0: exponential (Hocket-Sherby)
	EQ.7.0: load curves in three directions
	EQ.8.0: table with temperature dependence
	EQ.9.0: three-dimensional table with temperature and strain rate dependence
	EQ.10.0: table with pre-strain dependence. See Remarks .
P1	Material parameter: HR.EQ.1.0: tangent modulus HR.EQ.2.0: k , strength coefficient for Swift exponential hardening HR.EQ.4.0: a , coefficient for Voce exponential hardening HR.EQ.5.0: k , strength coefficient for Gosh exponential hardening HR.EQ.6.0: a , coefficient for Hocket-Sherby exponential hardening HR.EQ.7.0: load curve ID for hardening in the 45°-direction. See Remarks .
P2	Material parameter: HR.EQ.1.0: yield stress HR.EQ.2.0: n , exponent for Swift exponential hardening HR.EQ.4.0: c , coefficient for Voce exponential hardening HR.EQ.5.0: n , exponent for Gosh exponential hardening HR.EQ.6.0: c , coefficient for Hocket-Sherby exponential hardening HR.EQ.7.0: load curve ID for hardening in the 90°-direction. See Remarks .
ITER	Iteration flag for speed: EQ.0.0: fully iterative EQ.1.0: fixed at three iterations Generally, ITER = 0 is recommended. ITER = 1, however, is somewhat faster and may give acceptable results in most problems.

Lankford Parameters Card. This card is included if PB = 0 (see Card 4a/4b).

Card 2a	1	2	3	4	5	6	7	8
Variable	M	R00	R45	R90	LCID	E0	SPI	P3
Type	F	F	F	F	I	F	F	F

VARIABLE**DESCRIPTION**

M	m , exponent in Barlat's yield surface. If negative, the absolute value is used.
R00	<p>R_{00}, Lankford parameter in 0°-direction:</p> <p>GT.0.0: constant value</p> <p>LT.0.0: load curve or table ID = R00 which defines R_{00} as a function of plastic strain (curve) or as a function of temperature and plastic strain (table). See Remarks.</p>
R45	<p>R_{45}, Lankford parameter in 45°-direction:</p> <p>GT.0.0: constant value</p> <p>LT.0.0: load curve or table ID = R45 which defines R_{45} as a function of plastic strain (curve) or as a function of temperature and plastic strain (table). See Remarks.</p>
R90	<p>R_{90}, Lankford parameter in 90°-direction:</p> <p>GT.0.0: constant value</p> <p>LT.0.0: load curve or table ID = R90 which defines R_{90} as a function of plastic strain (curve) or as a function of temperature and plastic strain (table). See Remarks.</p>
LCID	Load curve/table ID for hardening in the 0° -direction. See Remarks .
E0	<p>Material parameter:</p> <p>HR.EQ.2.0: ϵ_0 for determining initial yield stress for Swift exponential hardening (default = 0.0)</p> <p>HR.EQ.4.0: b, coefficient for Voce exponential hardening</p> <p>HR.EQ.5.0: ϵ_0 for determining initial yield stress for Gosh exponential hardening (default = 0.0)</p>

VARIABLE	DESCRIPTION
	HR.EQ.6.0: b , coefficient for Hocket-Sherby exponential hardening
SPI	<p>Case I: If HR = 2.0 and E0 is zero, then ϵ_0 is determined by:</p> <p>EQ.0.0: $\epsilon_0 = \left(\frac{E}{k}\right)^{[1/(n-1)]}$, default</p> <p>LE.0.02: $\epsilon_0 = \text{SPI}$</p> <p>GT.0.02: $\epsilon_0 = \left(\frac{\text{SPI}}{k}\right)^{[1/n]}$</p> <p>Case II: If HR = 5.0, then the strain at plastic yield is determined by an iterative procedure based on the same principles as for HR = 2.0.</p>
P3	<p>Material parameter:</p> <p>HR.EQ.5.0: p, parameter for Gosh exponential hardening</p> <p>HR.EQ.6.0: n, exponent for Hocket-Sherby exponential hardening</p>

BARLAT89 Parameters Card. This card is included if PB > 0 (see Card 4a/4b).

Card 2b	1	2	3	4	5	6	7	8
Variable	M	AB	CB	HB	LCID	E0	SPI	P3
Type	F	F	F	F	I	F	F	F

VARIABLE	DESCRIPTION
M	m , exponent in Barlat's yield surface. If negative, the absolute value is used.
AB	a , Barlat89 parameter
CB	c , Barlat89 parameter
HB	h , Barlat89 parameter
LCID	Load curve/table ID for hardening in the 0°-direction. See Remarks .

VARIABLE	DESCRIPTION
E0	Material parameter: HR.EQ.2.0: ϵ_0 for determining initial yield stress for Swift exponential hardening (default = 0.0) HR.EQ.4.0: b , coefficient for Voce exponential hardening HR.EQ.5.0: ϵ_0 for determining initial yield stress for Gosh exponential hardening (default = 0.0) HR.EQ.6.0: b , coefficient for Hockett-Sherby exponential hardening
SPI	Case I: If HR = 2.0 and E0 is zero, then ϵ_0 is determined by: EQ.0.0: $\epsilon_0 = \left(\frac{E}{k}\right)^{1/(n-1)}$, default LE.0.02: $\epsilon_0 = \text{SPI}$ GT.0.02: $\epsilon_0 = \left(\frac{\text{SPI}}{k}\right)^{1/n}$ Case II: If HR = 5.0, then the strain at plastic yield is determined by an iterative procedure based on the same principles as for HR = 2.0.
P3	Material parameter: HR.EQ.5.0: p , parameter for Gosh exponential hardening HR.EQ.6.0: n , exponent for Hockett-Sherby exponential hardening

Define the following card if and only if $M < 0$

Card 3	1	2	3	4	5	6	7	8
Variable	CRC1	CRA1	CRC2	CRA2	CRC3	CRA3	CRC4	CRA4
Type	F	F	F	F	F	F	F	F

VARIABLE	DESCRIPTION
CRC n	Chaboche-Rousselier hardening parameters; see Remarks .
CRA n	Chaboche-Rousselier hardening parameters; see Remarks .

This card is included if the keyword option is not used (<BLANK>)

Card 4a	1	2	3	4	5	6	7	8
Variable	AOPT	C	P	VLCID		PB	HTA	HTB
Type	F	F	F	I		F	F	F

VARIABLE**DESCRIPTION**

AOPT

Material axes option (see `MAT_OPTIONTROPIC_ELASTIC` for a more complete description):

EQ.0.0: locally orthotropic with material axes determined by element nodes 1, 2, and 4, as with `*DEFINE_COORDINATE_NODES` and then rotated about the shell element normal by an angle BETA.

EQ.2.0: globally orthotropic with material axes determined by vectors defined below, as with `*DEFINE_COORDINATE_VECTOR`.

EQ.3.0: locally orthotropic material axes determined by rotating the material axes about the element normal by an angle, BETA, from a line in the plane of the element defined by the cross product of the vector, \mathbf{v} , with the element normal.

LT.0.0: the absolute value of AOPT is a coordinate system ID number (CID on `*DEFINE_COORDINATE_NODES`, `*DEFINE_COORDINATE_SYSTEM` or `*DEFINE_COORDINATE_VECTOR`). Available with the R3 release of Version 971 and later.

C

C in Cowper-Symonds strain rate model

P

p in Cowper-Symonds strain rate model. Set P to zero for no strain rate effects.

VLCID

Volume correction curve ID defining the relative volume change (change in volume relative to the initial volume) as a function of the effective plastic strain. This is only used when nonzero. See [Remarks](#).

PB

Barlat89 parameter, p . If $PB > 0$, parameters AB, CB, and HB are read instead of R00, R45, and R90. See [Remarks](#) below.

VARIABLE	DESCRIPTION
HTA	Load curve/Table ID for postforming parameter a in heat treatment
HTB	Load curve/Table ID for postforming parameter b in heat treatment

This card is included if the keyword option is NLP.

Card 4b	1	2	3	4	5	6	7	8
Variable	AOPT	C	P	VLCID		PB	NLP	
Type	F	F	F	I		F	I	

VARIABLE	DESCRIPTION
AOPT	<p>Material axes option (see MAT_OPTIONTROPIC_ELASTIC for a more complete description):</p> <p>EQ.0.0: locally orthotropic with material axes determined by element nodes 1, 2, and 4, as with *DEFINE_COORDINATE_NODES and then rotated about the shell element normal by an angle BETA.</p> <p>EQ.2.0: globally orthotropic with material axes determined by vectors defined below, as with *DEFINE_COORDINATE_VECTOR.</p> <p>EQ.3.0: locally orthotropic material axes determined by rotating the material axes about the element normal by an angle, BETA, from a line in the plane of the element defined by the cross product of the vector, \mathbf{v}, with the element normal.</p> <p>LT.0.0: the absolute value of AOPT is a coordinate system ID number (CID on *DEFINE_COORDINATE_NODES, *DEFINE_COORDINATE_SYSTEM or *DEFINE_COORDINATE_VECTOR). Available with the R3 release of Version 971 and later.</p>
C	C in Cowper-Symonds strain rate model
P	p in Cowper-Symonds strain rate model. Set P to zero for no strain rate effects.

VARIABLE	DESCRIPTION
VLCID	Volume correction curve ID defining the relative volume change (change in volume relative to the initial volume) as a function of the effective plastic strain. This is only used when nonzero. See Remarks .
PB	Barlat89 parameter, p . If $PB > 0$, parameters AB, CB, and HB are read instead of R00, R45, and R90. See Remarks below.
NLP	ID of a load curve of the Forming Limit Diagram (FLD) under linear strain paths. In the load curve, abscissas represent minor strains while ordinates represent major strains. Define only when option NLP is used. See Remarks .

Card 5	1	2	3	4	5	6	7	8
Variable				A1	A2	A3	HTC	HTD
Type				F	F	F	F	F

VARIABLE	DESCRIPTION
A1, A2, A3	Components of vector \mathbf{a} for AOPT = 2
HTC	Load curve/table ID for postforming parameter c in heat treatment
HTD	Load curve/table ID for postforming parameter d in heat treatment

Card 6	1	2	3	4	5	6	7	8
Variable	V1	V2	V3	D1	D2	D3	BETA	HTFLAG
Type	F	F	F	F	F	F	F	F

VARIABLE	DESCRIPTION
V1, V2, V3	Components of vector \mathbf{v} for AOPT = 3
D1, D2, D3	Components of vector \mathbf{d} for AOPT = 2

VARIABLE	DESCRIPTION
BETA	Material angle in degrees for AOPT = 0 and 3. It may be overridden on the element card; see *ELEMENT_SHELL_BETA.
HTFLAG	Heat treatment flag (see Remarks): EQ.0: preforming stage EQ.1: heat treatment stage EQ.2: postforming stage

Optional card.

Card 7	1	2	3	4	5	6	7	8
Variable	USRFAIL	LCBI	LCSH					
Type	F	F	F					

VARIABLE	DESCRIPTION
USRFAIL	User defined failure flag: EQ.0: no user subroutine is called. EQ.1: user subroutine matusr_24 in dyn21.f is called.
LCBI	HR.EQ.7: load curve defining biaxial stress as a function of biaxial strain for hardening rule; see discussion in the formulation section below for a definition. HR.NE.7: ignored
LCSH	HR.EQ.7: load curve defining shear stress as a function of shear strain for hardening; see discussion in the formulation section below for a definition. HR.NE.7: ignored

Formulation:

The effective plastic strain used in this model is defined to be plastic work equivalent. A consequence of this is that for parameters defined as functions of effective plastic strain, the rolling (00) direction should be used as reference direction. For instance, the hardening curve for HR = 3 is the stress as function of strain for uniaxial tension in the rolling

direction, VLCID curve should give the relative volume change as function of strain for uniaxial tension in the rolling direction and load curve given by $-E$ should give the Young's modulus as function of strain for uniaxial tension in the rolling direction. Optionally, the curve can be substituted for a table defining hardening as function of plastic strain rate (HR = 3), temperature (HR = 8), or pre-strain (HR = 10).

Exceptions from the rule above are curves defined as functions of plastic strain in the 45° and 90° directions, i.e., $P1$ and $P2$ for HR = 7 and negative R45 or R90, see Fleischer et.al. [2007]. The hardening curves are here defined as measured stress as function of measured plastic strain for uniaxial tension in the direction of interest, i.e., as determined from experimental testing using a standard procedure. The optional biaxial and shear hardening curves require some further elaboration, as we assume that a biaxial or shear test reveals that the true stress tensor in the material system expressed as

$$\sigma = \begin{pmatrix} \sigma & 0 \\ 0 & \pm\sigma \end{pmatrix}, \quad \sigma \geq 0,$$

is a function of the (plastic) strain tensor

$$\varepsilon = \begin{pmatrix} \varepsilon_1 & 0 \\ 0 & \pm\varepsilon_2 \end{pmatrix}, \quad \varepsilon_1 \geq 0, \quad \varepsilon_2 \geq 0,$$

The input hardening curves are σ as function of $\varepsilon_1 + \varepsilon_2$. The \pm sign above distinguishes between the biaxial (+) and the shear (-) cases. Moreover, the curves defining the R -values are as function of the measured plastic strain for uniaxial tension in the direction of interest. These curves are transformed internally to be used with the effective stress and strain properties in the actual model. The effective plastic strain does not coincide with the plastic strain components in other directions than the rolling direction and may be somewhat confusing to the user. Therefore the von Mises work equivalent plastic strain is output as history variable #2 if HR = 7 or if any of the R -values is defined as function of the plastic strain.

The R -values in curves are defined as the ratio of instantaneous width change to instantaneous thickness change. That is, assume that the width W and thickness T are measured as function of strain. Then the corresponding R -values is given by:

$$R = \frac{\frac{dW}{d\varepsilon} / W}{\frac{dT}{d\varepsilon} / T}$$

The anisotropic yield criterion Φ for plane stress is defined as:

$$\Phi = a|K_1 + K_2|^m + a|K_1 - K_2|^m + c|2K_2|^m = 2\sigma_Y^m$$

where σ_Y is the yield stress and $K_{i=1,2}$ are given by:

$$K_1 = \frac{\sigma_x + h\sigma_y}{2}$$

$$K_2 = \sqrt{\left(\frac{\sigma_x - h\sigma_y}{2}\right)^2 + p^2 \tau_{xy}^2}$$

If $PB = 0$, the anisotropic material constants a, c, h and p are obtained through R_{00}, R_{45} and R_{90} :

$$a = 2 - 2\sqrt{\left(\frac{R_{00}}{1 + R_{00}}\right)\left(\frac{R_{90}}{1 + R_{90}}\right)}$$

$$c = 2 - a$$

$$h = \sqrt{\left(\frac{R_{00}}{1 + R_{00}}\right)\left(\frac{1 + R_{90}}{R_{90}}\right)}$$

The anisotropy parameter p is calculated implicitly. According to Barlat and Lian the R -value, width to thickness strain ratio, for any angle ϕ can be calculated from:

$$R_\phi = \frac{2m\sigma_Y^m}{\left(\frac{\partial\Phi}{\partial\sigma_x} + \frac{\partial\Phi}{\partial\sigma_y}\right)\sigma_\phi} - 1$$

where σ_ϕ is the uniaxial tension in the ϕ direction. This expression can be used to iteratively calculate the value of p . Let $\phi = 45$ and define a function g as:

$$g(p) = \frac{2m\sigma_Y^m}{\left(\frac{\partial\Phi}{\partial\sigma_x} + \frac{\partial\Phi}{\partial\sigma_y}\right)\sigma_\phi} - 1 - R_{45}$$

An iterative search is used to find the value of p . If $PB > 0$, material parameters $a(AB)$, $c(CB)$, $h(HB)$, and $p(PB)$ are used directly.

The effective stress, given as

$$\sigma_{\text{eff}} = \left\{ \frac{1}{2} (a|K_1 + K_2|^m + a|K_1 - K_2|^m + c|2K_2|^m) \right\}^{1/m}$$

can be output to the D3plot database through *DEFINE_MATERIAL_HISTORIES.

*DEFINE_MATERIAL_HISTORIES Properties		
Label	Attributes	Description
Effective Stress	- - - -	Effective stress σ_{eff} , see above

For face centered cubic (FCC) materials $m = 8$ is recommended and for body centered cubic (BCC) materials $m = 6$ may be used. The yield strength of the material can be expressed in terms of k and n :

$$\sigma_y = k\varepsilon^n = k(\varepsilon_{yp} + \bar{\varepsilon}^p)^n$$

where ε_{yp} is the elastic strain to yield and $\bar{\varepsilon}^p$ is the effective plastic strain (logarithmic). If SIGY is set to zero, the strain to yield is found by solving for the intersection of the linearly elastic loading equation with the strain hardening equation:

$$\begin{aligned}\sigma &= E\varepsilon \\ \sigma &= k\varepsilon^n\end{aligned}$$

which gives the elastic strain at yield as:

$$\varepsilon_{yp} = \left(\frac{E}{k}\right)^{\frac{1}{n-1}}$$

If SIGY yield is nonzero and greater than 0.02 then:

$$\varepsilon_{yp} = \left(\frac{\sigma_y}{k}\right)^{\frac{1}{n}}$$

The other available hardening models include the Voce equation given by:

$$\sigma_Y(\varepsilon_p) = a - be^{-c\varepsilon_p},$$

the Gosh equation given by:

$$\sigma_Y(\varepsilon_p) = k(\varepsilon_0 + \varepsilon_p)^n - p,$$

and finally the Hockett-Sherby equation given by:

$$\sigma_Y(\varepsilon_p) = a - be^{-c\varepsilon_p^n}.$$

For the Gosh hardening law, the interpretation of the variable SPI is the same, i.e., if set to zero the strain at yield is determined implicitly from the intersection of the strain hardening equation with the linear elastic equation.

To include strain rate effects in the model we multiply the yield stress by a factor depending on the effective plastic strain rate. We use the Cowper-Symonds' model; hence the yield stress can be written as:

$$\sigma_Y(\varepsilon_p, \dot{\varepsilon}_p) = \sigma_Y^s(\varepsilon_p) \left\{ 1 + \left(\frac{\dot{\varepsilon}_p}{C}\right)^{1/p} \right\}$$

where σ_Y^s denotes the static yield stress, C and p are material parameters, and $\dot{\varepsilon}_p$ is the effective plastic strain rate. With HR.EQ.3 strain rate effects can be defined using a table, in which each load curve in the table defines the yield stress as function of plastic strain for a given strain rate. In contrast to material 24, when the strain rate is larger than that of any curve in the table, the table is extrapolated in the strain rate direction to find the appropriate yield stress.

A kinematic hardening model is implemented following the works of Chaboche and Roussilier. A back stress α is introduced such that the effective stress is computed as:

$$\sigma_{\text{eff}} = \sigma_{\text{eff}}(\sigma_{11} - 2\alpha_{11} - \alpha_{22}, \sigma_{22} - 2\alpha_{22} - \alpha_{11}, \sigma_{12} - \alpha_{12})$$

The back stress is the sum of up to four terms according to:

$$\alpha_{ij} = \sum_{k=1}^4 \alpha_{ij}^k$$

and the evolution of each back stress component is as follows:

$$\delta \alpha_{ij}^k = C_k \left(a_k \frac{s_{ij} - \alpha_{ij}}{\sigma_{\text{eff}}} - \alpha_{ij}^k \right) \delta \varepsilon_p$$

where C_k and a_k are material parameters, s_{ij} is the deviatoric stress tensor, σ_{eff} is the effective stress and ε_p is the effective plastic strain. The yield condition is for this case modified according to

$$f(\boldsymbol{\sigma}, \boldsymbol{\alpha}, \varepsilon_p) = \sigma_{\text{eff}}(\sigma_{11} - 2\alpha_{11} - \alpha_{22}, \sigma_{22} - 2\alpha_{22} - \alpha_{11}, \sigma_{12} - \alpha_{12}) - \left\{ \sigma_Y^t(\varepsilon_p, \dot{\varepsilon}_p, 0) - \sum_{k=1}^4 a_k [1 - \exp(-C_k \varepsilon_p)] \right\} \leq 0$$

in order to get the expected stress strain response for uniaxial stress. The calculated effective stress is stored in history variable #7.

With hardening rule HR = 10, the flow curves in a table definition can be based on different pre-strain values. Hence flow curves can have varying shapes as defined in the corresponding table. For example, the plastic strain distribution as obtained in a first step of a two-stage procedure is initialized in the next stage with *INITIAL_STRESS_SHELL and corresponding values for EPS. With HR = 10 this pre-strain is initially transferred to history variable #9 and all stresses and other history variables are set to zero assuming that the part was subjected to an annealing phase. With EPS now stored on history variable #9 the table lookup for the actual yield value may now be used to interpolate on differently shaped flow curves.

A failure criterion for nonlinear strain paths (NLP) in sheet metal forming:

When the option NLP is used, a necking failure criterion is activated to account for the non-linear strain path effect in sheet metal forming. Based on the traditional Forming Limit Diagram (FLD) for the linear strain path, the Formability Index (F.I.) is calculated for every element in the model throughout the simulation duration. The entire F.I. time history for every element is stored in history variable #1 in d3plot files, accessible from *Post/History* menu in *LS-PrePost* v4.0. In addition to the F.I. output, other useful information stored in other history variables can be found as follows,

1. Formability Index: #1
2. Strain ratio (in-plane minor strain increment/major strain increment): #2
3. Effective strain from the planar isotropic assumption: #3

To enable the output of these history variables to the d3plot files, NEIPS on the *DATABASE_EXTENT_BINARY card must be set to at least 3. The history variables can also be plotted on the formed sheet blank as a color contour map, accessible from *Post/FriComp/Misc* menu. The index value starts from 0.0, with the onset of necking failure when it reaches 1.0. The F.I. is calculated based on critical effect strain method, as explained in manual pages in *MAT_037. The theoretical background based on two papers can also be found in manual pages in *MAT_037.

When d3plot files are used to plot the history variable #1 (the F.I.) in color contour, the value in the *Max* pull-down menu in *Post/FriComp* needs to be set to *Min*, meaning that the necking failure occurs only when all integration points through the thickness have reached the critical value of 1.0 (refer to *Tharrett and Stoughton's paper in 2003 SAE 2003-01-1157*). It is also suggested to set the variable "MAXINT" in *DATABASE_EXTENT_BINARY to the same value as the variable "NIP" in *SECTION_SHELL. In addition, the value in the *Avg* pull-down menu in *Post/FriRang* needs to be set to *None*. The strain path history (major vs. minor strain) of each element can be plotted with the radial dial button *Strain Path* in *Post/FLD*.

An example of a partial input for the material is provided below, where the FLD for the linear strain path is defined by the variable NLP with load curve ID 211, where abscissas represent minor strains and ordinates represent major strains.

```

*MAT_3-PARAMETER_BARLAT_NLP
$---+---1---+---2---+---3---+---4---+---5---+---6---+---7---+---8
$      MID          RO          E          PR          HR          P1          P2          ITER
$      1  2.890E-09  6.900E04    0.330    3.000
$      M          R00          R45          R90          LCID          E0          SPI          P3
$      8.000    0.800    0.600    0.550    99
$      AOPT          C          P          VLCID          NLP
$      2.000
$
$              A1          A2          A3
$              0.000    1.000    0.000
$      V1          V2          V3          D1          D2          D3          BETA
$
$---+---1---+---2---+---3---+---4---+---5---+---6---+---7---+---8
$ Hardening Curve
*DEFINE_CURVE
  99
      0.000          130.000
      0.002          134.400
      0.006          143.000
      0.010          151.300
      0.014          159.300
      ⋮
      0.900          365.000
      1.000          365.000
$ FLD Definition
*DEFINE_CURVE
211
      -0.2          0.325
      -0.1054      0.2955
      -0.0513      0.2585
      0.0000      0.2054
      0.0488      0.2240
      0.0953      0.2396
      0.1398      0.2523

```

0.1823 0.2622
⋮ ⋮

Shown in [Figures M36-1, M36-2](#) and [M36-3](#), predictions and validations of forming limit curves (FLC) of various nonlinear strain paths on a single shell element was done using this new option, for an Aluminum alloy with $R_{00} = 0.8$, $R_{45} = 0.6$ and $R_{90} = 0.55$ and the yield at 130.0 MPa. In each case, the element is further strained in three different paths (uniaxial stress – U.A., plane strain – P.S., and equi-biaxial strain – E.B.) separately, following a pre-straining in uniaxial, plane strain and equi-biaxial strain state, respectively. The forming limits are determined at the end of the secondary straining for each path, when the F.I. has reached the value of 1.0. It is seen that the predicted FLCs (dashed curves) in case of the nonlinear strain paths are totally different from the FLCs under the linear strain paths. It is noted that the current predicted FLCs under nonlinear strain path are obtained by connecting the ends of the three distinctive strain paths. More detailed FLCs can be obtained by straining the elements in more paths between U.A. and P.S. and between P.S. and E.B. In [Figure M36-4](#), time-history plots of F.I., strain ratio and effective strain are shown for uniaxial pre-strain followed by equi-biaxial strain path on the same single element.

Typically, to assess sheet formability, F.I. contour of the entire part should be plotted. Based on the contour plot, non-linear strain path and the F.I. time history of a few elements in the area of concern can be plotted for further study. These plots are similar to those shown in manual pages of *MAT_037.

Smoothing of the strain ratio β :

*CONTROL_FORMING_STRAIN_RATIO_SMOOTH applies a smoothing algorithm to reduce output noise level of the strain ratio β (in-plane minor strain increment/major strain increment) which is used to calculate the Formability Index.

Support of non-integer flow potential exponent m :

Starting in Dev139482, non-integer value of the exponent m is supported for the option NLP.

Heat treatment with variable HTFLAG:

Heat treatment for increasing the formability of prestrained aluminum sheets can be simulated through the use of HTFLAG, where the intention is to run a forming simulation in steps involving preforming, springback, heat treatment and postforming. In each step the history is transferred to the next via the use of dynain (see *INTERFACE_SPRINGBACK). The first two steps are performed with HTFLAG = 0 according to standard procedures, resulting in a plastic strain field ϵ_p^0 corresponding to the prestrain. The heat treatment step is performed using HTFLAG = 1 in a coupled thermomechanical

simulation, where the blank is heated. The coupling between thermal and mechanical is only that the maximum temperature T^0 is stored as a history variable in the material model, this corresponding to the heat treatment temperature. Here it is important to export all history variables to the dynein file for the postforming step. In the final postforming step, HTFLAG = 2, the yield stress is then augmented by the Hockett-Sherby like term:

$$\Delta\sigma = b - (b - a)\exp\left[-c(\varepsilon_p - \varepsilon_p^0)^d\right]$$

where a, b, c and d are given as tables as functions of the heat treatment temperature T^0 and prestrain ε_p^0 . That is, in the table definitions each load curve corresponds to a given prestrain and the load curve value is with respect to the heat treatment temperature,

$$a = a(T^0, \varepsilon_p^0) \quad b = b(T^0, \varepsilon_p^0) \quad c = c(T^0, \varepsilon_p^0) \quad d = d(T^0, \varepsilon_p^0)$$

The effect of heat treatment is that the material strength decreases but hardening increases, thus typically:

$$a \leq 0 \quad b \geq a \quad c > 0 \quad d > 0$$

Revision information:

The option NLP is available starting in Dev 95576 in explicit dynamic analysis, and in SMP and MPP.

1. Smoothing of β is available starting in Revision 109781.
2. Dev139482: non-integer value of the exponent m is supported for the option NLP.

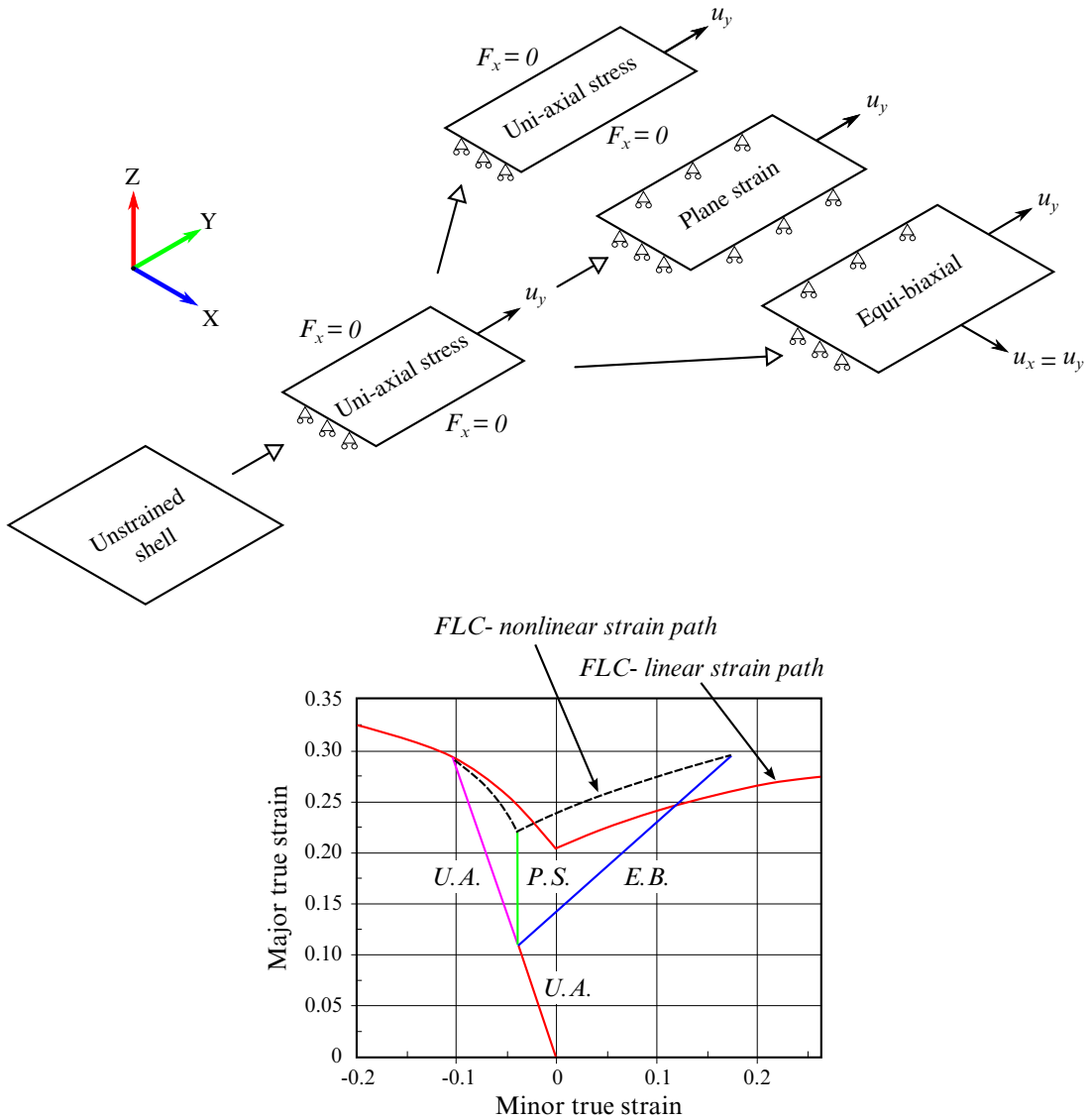

Figure M36-1. Nonlinear FLD prediction with uniaxial pre-straining.

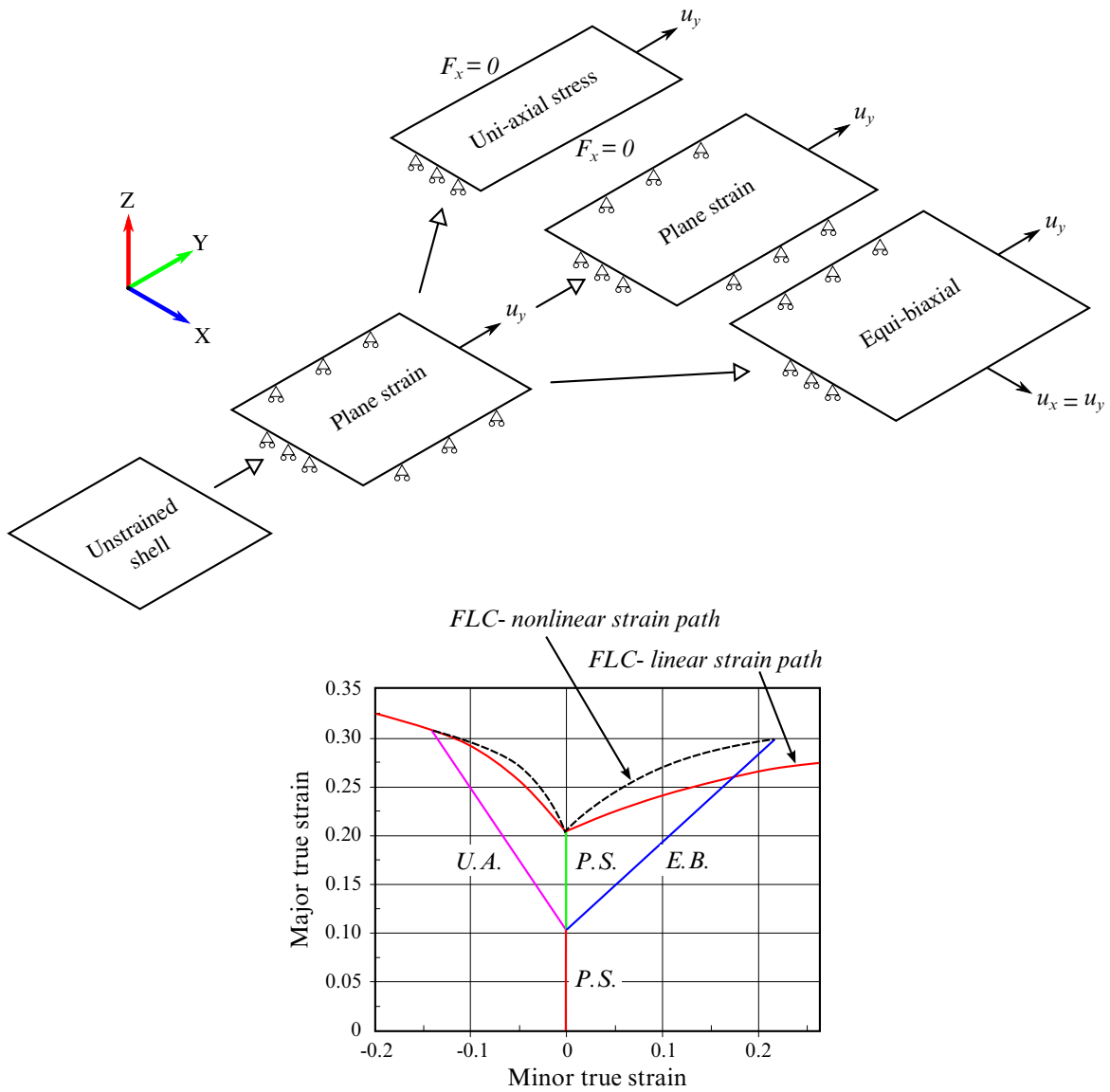

Figure M36-2. Nonlinear FLD prediction with plane strain pre-straining.

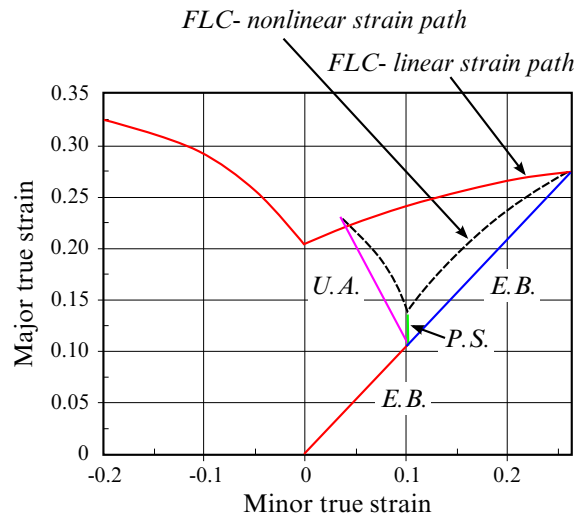
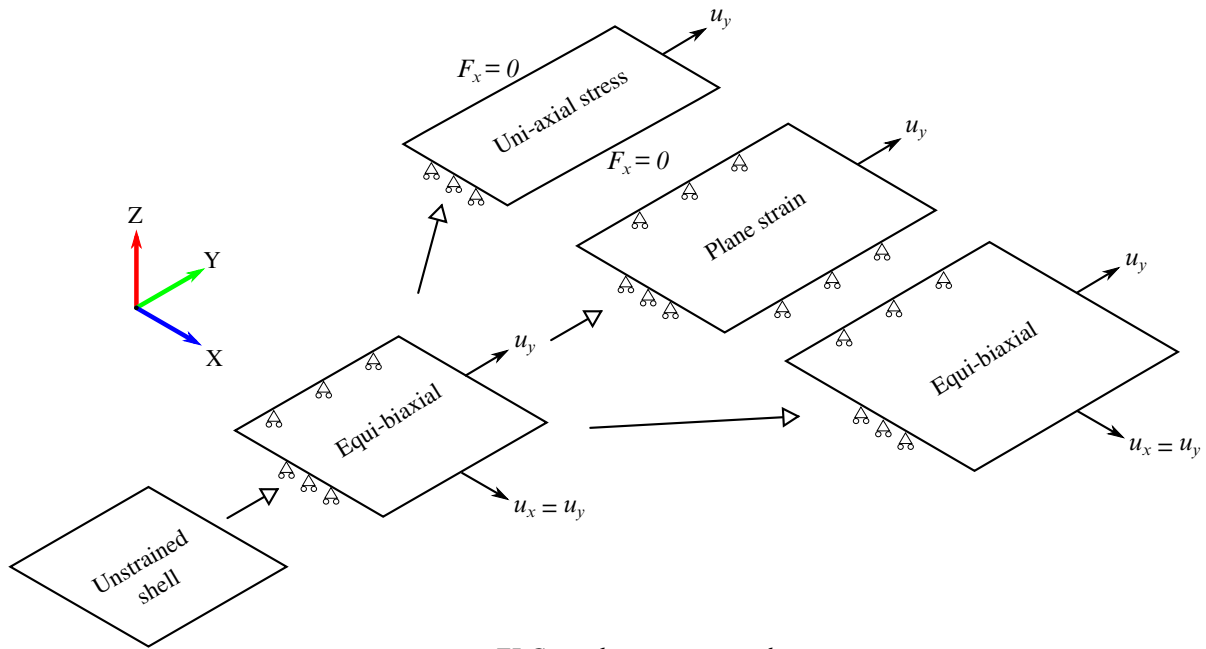

Figure M36-3. Nonlinear FLD prediction with equi-biaxial pre-straining.

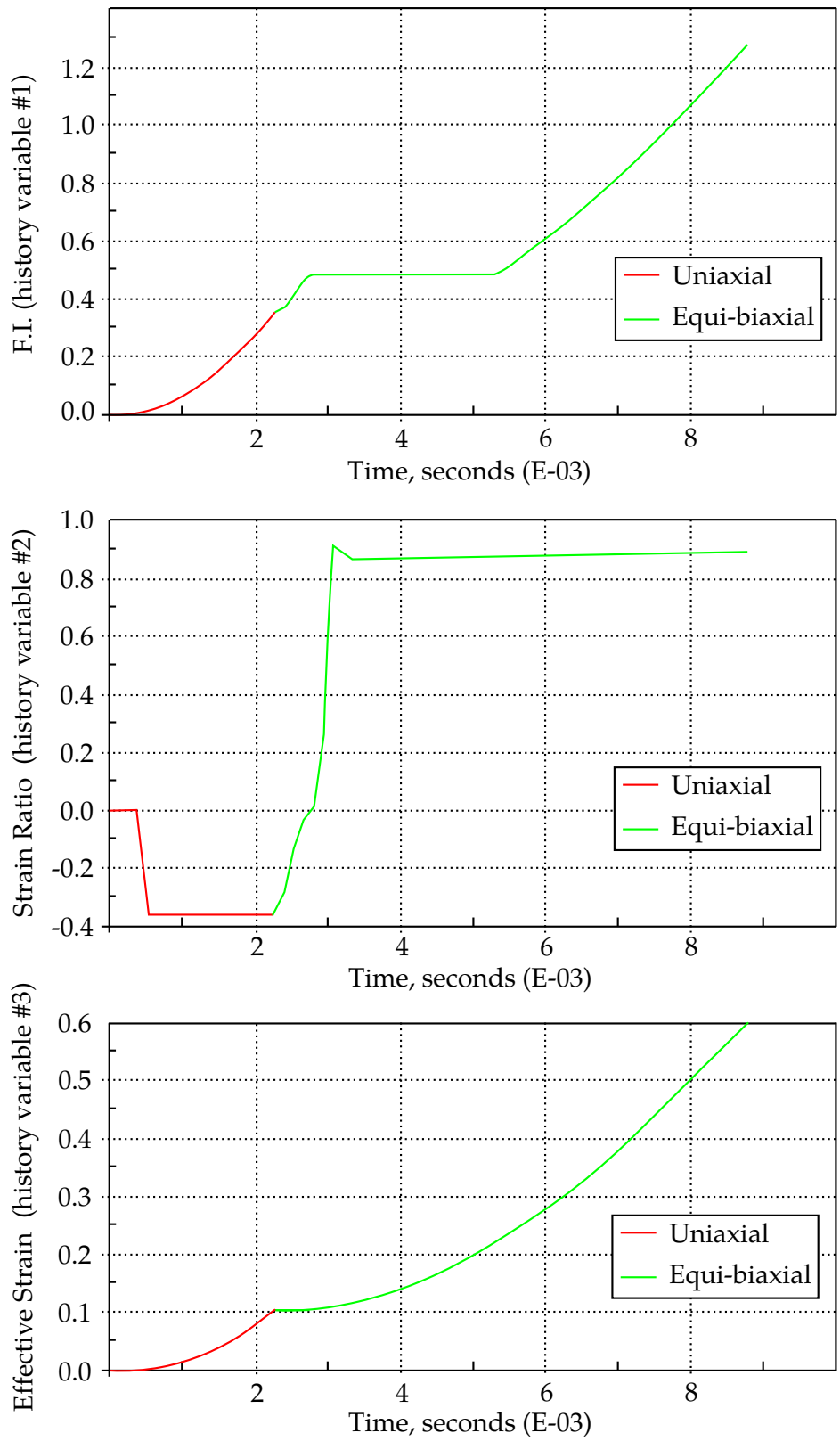

Figure M36-4. Time-history plots of the three history variables.

***MAT_EXTENDED_3-PARAMETER_BARLAT**

This is Material Type 36E. This model is an extension to the standard 3-parameter Barlat model and allows for different hardening curves and R-values in different directions, see Fleischer et.al. [2007]. The directions in this context are the three uniaxial directions (0, 45 and 90 degrees) and optionally biaxial and shear.

Card 1	1	2	3	4	5	6	7	8
Variable	MID	R0	E	PR				
Type	A	F	F	F				

Card 2	1	2	3	4	5	6	7	8
Variable	LCH00	LCH45	LCH90	LCHBI	LCHSH	HOSF		
Type	F	F	F	F	F	F		

Card 3	1	2	3	4	5	6	7	8
Variable	LCR00	LCR45	LCR90	LCRBI	LCRSH	M		
Type	F	F	F	F	F	F		

Card 4	1	2	3	4	5	6	7	8
Variable	AOPT							
Type	F							

Card 5	1	2	3	4	5	6	7	8
Variable				A1	A2	A3		
Type				F	F	F		

Card 6	1	2	3	4	5	6	7	8
Variable	V1	V2	V3	D1	D2	D3	BETA	
Type	F	F	F	F	F	F	F	

VARIABLE**DESCRIPTION**

MID	Material identification. A unique number or label must be specified (see *PART).
RO	Mass density.
E	Young's modulus, E .
PR	Poisson's ratio, ν .
LCHXX	Load curve/table defining uniaxial stress vs. uniaxial strain and strain rate in the given direction (XX is either 00, 45, 90). The exact definition is discussed in the Remarks below. LCH00 must be defined, the other defaults to LCH00 if not defined.
LCHBI	Load curve/table defining biaxial stress vs. biaxial strain and strain rate, see discussion in the Remarks below for a definition. If not defined this is determined from LCH00 and the initial R-values to yield a response close to the standard 3-parameter Barlat model.
LCHSH	Load curve/table defining shear stress vs. shear strain and strain rate, see discussion in the Remarks below for a definition. If not defined this is ignored to yield a response close to the standard 3-parameter Barlat model.
HOSF	Hosford option for enhancing convexity of yield surface, set to 1 to activate.
LCRXX	Load curve defining standard R-value vs. uniaxial strain in the given direction (XX is either 00, 45, 90). The exact definition is discussed in the Remarks below. Default is a constant R-value of 1.0, a negative input will result in a constant R-value of $-LCRXX$.

VARIABLE	DESCRIPTION
LCRBI	Load curve defining biaxial R-value vs. biaxial strain, see discussion in the Remarks below for a definition. Default is a constant R-value of 1.0, a negative input will result in a constant R-value of $-LCRBI$.
LCRSH	Load curve defining shear R-value vs. shear strain, see discussion in the Remarks below for a definition. Default is a constant R-value of 1.0, a negative input will result in a constant R-value of $-LCRSH$.
M	Barlat flow exponent, m , must be an integer value.
AOPT	Material axes option (see <code>MAT_OPTION TROPIC_ELASTIC</code> for a more complete description): <p>EQ.0.0: locally orthotropic with material axes determined by element nodes 1, 2, and 4, as with <code>*DEFINE_COORDINATE_NODES</code>, and then rotated about the shell element normal by an angle BETA.</p> <p>EQ.2.0: globally orthotropic with material axes determined by vectors defined below, as with <code>*DEFINE_COORDINATE_VECTOR</code>.</p> <p>EQ.3.0: locally orthotropic material axes determined by rotating the material axes about the element normal by an angle, BETA, from a line in the plane of the element defined by the cross product of the vector \mathbf{v} with the element normal.</p> <p>LT.0.0: the absolute value of AOPT is a coordinate system ID number (CID on <code>*DEFINE_COORDINATE_NODES</code>, <code>*DEFINE_COORDINATE_SYSTEM</code> or <code>*DEFINE_COORDINATE_VECTOR</code>).</p>
XP, YP, ZP	Coordinates of point \mathbf{p} for AOPT = 1.
A1, A2, A3	Components of vector \mathbf{a} for AOPT = 2.
V1, V2, V3	Components of vector \mathbf{v} for AOPT = 3.
D1, D2, D3	Components of vector \mathbf{d} for AOPT = 2.
BETA	Material angle in degrees for AOPT = 0 and 3, may be overridden on the element card, see <code>*ELEMENT_SHELL_BETA</code> .

Formulation:

The standard 3-parameter Barlat model incorporates plastic anisotropy in a fairly moderate sense, allowing for the specification of R-values in three different directions, together with a stress level in the reference direction (termed *rolling* or *0 degree* direction), but not more than that. To allow for a more accurate representation of a more severe anisotropic material, like in rolled aluminium sheet components, one could migrate to the Barlat YLD2000 model (material 133 in LS-DYNA) which also allows for specifying stress levels in the two remaining directions as well as stress and strain data at an arbitrary point on the yield surface. The properties of extruded aluminium however, are such that neither of these two material models are sufficient to describe its extreme anisotropy. One particular observation from experiments is that anisotropy evolves with deformation, a feature that is not captured in any of the material models discussed so far. The present extended version of material 36 was therefore developed in an attempt to fill this void in the LS-DYNA material library. In short, this material allows for R-values and stress levels in the three directions, together with similar data in biaxial and shear directions. *And*, these properties are functions of the effective plastic strain so as to allow for deformation induced anisotropy. The following is an explanation of its parameters.

The hardening curves or tables LCH00, LCH45 and LCH90 are here defined as measured stress as function of measured plastic strain (and potentially rate) for uniaxial tension in the direction of interest, i.e., as determined from experimental testing using a standard procedure. The optional biaxial and shear hardening curves LCHBI and LCHSH require some further elaboration, as we assume that a biaxial or shear test reveals that the true stress tensor in the material system expressed as

$$\sigma = \begin{pmatrix} \sigma & 0 \\ 0 & \pm\sigma \end{pmatrix}, \quad \sigma \geq 0,$$

is a function of the (plastic) strain tensor

$$\varepsilon = \begin{pmatrix} \varepsilon_1 & 0 \\ 0 & \pm\varepsilon_2 \end{pmatrix}, \quad \varepsilon_1 \geq 0, \quad \varepsilon_2 \geq 0,$$

The input hardening curves are σ as function of $\varepsilon_1 + \varepsilon_2$. The \pm sign above distinguishes between the biaxial (+) and the shear (−) cases.

Moreover, the curves LCR00, LCR45 and LCR90 defining the R values are as function of the measured plastic strain for uniaxial tension in the direction of interest. The R-values in themselves are defined as the ratio of instantaneous width change to instantaneous thickness change. That is, assume that the width W and thickness T are measured as function of strain. Then the corresponding R-value is given by:

$$R_\varphi = \frac{\frac{dW}{d\varepsilon} / W}{\frac{dT}{d\varepsilon} / T}.$$

These curves are transformed internally to be used with the effective stress and strain properties in the actual model. The effective plastic strain does not coincide with the plastic strain components in other directions than the rolling direction and may be somewhat confusing to the user. Therefore the von Mises work equivalent plastic strain is output as history variable #2. As for hardening, the optional biaxial and shear R-value curves LCRBI and LCRSH are defined in a special way for which we return to the local plastic strain tensor ε as defined above. The biaxial and shear R-values are defined as

$$R_{b/s} = \frac{\dot{\varepsilon}_1}{\dot{\varepsilon}_2}$$

and again the curves are $R_{b/s}$ as function of $\varepsilon_1 + \varepsilon_2$. Note here that the suffix b assumes loading biaxially and s assumes loading in shear, so the R-values to be defined are always positive.

The option HOSF = 0 is equivalent to the standard Barlat model with HR = 7 whose yield function can be expressed by the potential Φ as given in the remarks for *MAT_3-PARAMETER_BARLAT. The HOSF = 1 allows for a "Hosford-based" effective stress in the yield function instead of using the Barlat-based effective stress. If the material and principal axes are coincident, the plastic potential Φ for HOSF = 1 can be written as

$$\Phi(\sigma) = \frac{1}{2} (|\sigma_1|^m + |\sigma_2|^m + |\sigma_1 - \sigma_2|^m) - \sigma_y^m$$

The main difference is that the Barlat-based effective stress contains the orthotropic parameters a, c, h and p in the yield function meanwhile the Hosford-based effective stress does not contain any information about the anisotropy. For HOSF = 1, the information about direction dependent yielding is directly obtained from the hardening curves LCH00, LCH45 and LCH90. For materials exhibiting very dissimilar R -values in the different material directions (e.g. typical aluminum extrusion), HOSF = 0 might (but does not necessarily) lead to concave yield surfaces which, in turn, might lead to numerical instabilities under certain circumstances. HOSF = 1 tends to reduce this effect.

More information on the theoretical and numerical foundations of HOSF = 1 can be found on the paper by Andrade, Borrvall, DuBois and Feucht, *A Hosford-based orthotropic plasticity model in LS-DYNA* (2019).

***MAT_TRANSVERSELY_ANISOTROPIC_ELASTIC_PLASTIC_{OPTION}**

This is Material Type 37. This model is for simulating sheet forming processes with anisotropic material. Only transverse anisotropy can be considered. Optionally an arbitrary dependency of stress and effective plastic strain can be defined with a load curve. This plasticity model is fully iterative and is available only for shell elements.

Available options include:

<BLANK>

ECHANGE

NLP_FAILURE

NLP2

The ECHANGE option allows the Young's Modulus to change during the simulation:

The NLP_FAILURE option estimates failure using the Formability Index (F.I.) which accounts for the non-linear strain paths common in metal forming application (see [Remarks 5](#) and [7](#)). The option NLP is also available for *MAT_036, *MAT_125 and *MAT_226. A related keyword is *CONTROL_FORMING_STRAIN_RATIO_SMOOTH, which applies a smoothing algorithm to reduce output noise level of the strain ratio β (in-plane minor strain increment/major strain increment) when calculating F.I.

The NLP_FAILURE option uses effective plastic strain to calculate the onset of necking, which assumes the necking happens in an instant. However, necking may occur over a longer duration which the option NLP2 is developed to address. NLP2 calculates the damage during forming and accumulates it to predict the sheet metal failure.

Card 1	1	2	3	4	5	6	7	8
Variable	MID	RO	E	PR	SIGY	ETAN	R	HLCID
Type	A	F	F	F	F	F	F	F

Additional card for ECHANGE and/or NLP_FAILURE keyword options.

Card 2	1	2	3	4	5	6	7	8
Variable	IDSCALE	EA	COE	ICFLD		STRAINLT		
Type	I	F	F	F		F		

VARIABLE**DESCRIPTION**

MID	Material identification. A unique number or label must be specified (see *PART).
RO	Mass density
E	Young's modulus
PR	Poisson's ratio
SIGY	Yield stress
ETAN	<p>Plastic hardening modulus. When this value is negative, normal stresses (either from contact or applied pressure) are considered and *LOAD_SURFACE_STRESS must be used to capture the stresses. This feature is applicable to both shell element types 2 and 16. It is found in some cases this inclusion can improve accuracy.</p> <p>The negative local z-stresses caused by the contact pressure can be viewed from d3plot files after Revision 97158. Prior to Revision 97158, the negative local z-stresses are stored in <i>history variable</i> #5.</p>
R	<p>Anisotropic parameter \bar{r}, also commonly called r-bar, in sheet metal forming literature. Its interpretation is given in Remark 1.</p> <p>GT.0: standard formulation</p> <p>LT.0: the anisotropic parameter is set to R. When R is set to a negative value the algorithm is modified for better stability in sheet thickness or thinning for sheet metal forming involving high strength steels or in cases when the simulation time is long. This feature is available to both element formulations 2 and 16. See Remark 2 and Figure M37-1.</p>
HLCID	Load curve ID expressing effective yield stress as a function of effective plastic strain in uniaxial tension.

VARIABLE	DESCRIPTION
IDSCALE	Load curve ID expressing the scale factor for the Young's modulus as a function of effective plastic strain. If the EA and COE fields are specified, this curve is unnecessary. This field is only used and should only be specified when the option ECHANGE is active.
EA, COE	Coefficients defining the Young's modulus with respect to the effective plastic strain, EA is E^A and COE is ζ . If IDSCALE is defined, these two parameters are not necessary. Input only when the option ECHANGE is used.
ICFLD	ID of a load curve of the Forming Limit Diagram (FLD) under linear strain paths (see Remark 6). In the load curve, abscissas represent minor strains while ordinates represent major strains. Define only when the option NLP_FAILURE is active.
STRAINLT	Critical strain value at which strain averaging is activated. Input only when the option NLP_FAILURE is active. See Remark 8 .

Remarks:

1. **Formulation.** Consider Cartesian reference axes which are parallel to the three symmetry planes of anisotropic behavior. Then, the yield function suggested by Hill [1948] can be written as:

$$F(\sigma_{22} - \sigma_{33})^2 + G(\sigma_{33} - \sigma_{11})^2 + H(\sigma_{11} - \sigma_{22})^2 + 2L\sigma_{23}^2 + 2M\sigma_{31}^2 + 2N\sigma_{12}^2 - 1 = 0$$

where σ_{y1} , σ_{y2} , and σ_{y3} are the tensile yield stresses and σ_{y12} , σ_{y23} , and σ_{y31} are the shear yield stresses. The constants F , G , H , L , M , and N are related to the yield stress by:

$$2F = \frac{1}{\sigma_{y2}^2} + \frac{1}{\sigma_{y3}^2} - \frac{1}{\sigma_{y1}^2}$$

$$2G = \frac{1}{\sigma_{y3}^2} + \frac{1}{\sigma_{y1}^2} - \frac{1}{\sigma_{y2}^2}$$

$$2H = \frac{1}{\sigma_{y1}^2} + \frac{1}{\sigma_{y2}^2} - \frac{1}{\sigma_{y3}^2}$$

$$2L = \frac{1}{\sigma_{y23}^2}$$

$$2M = \frac{1}{\sigma_{y31}^2}$$

$$2N = \frac{1}{\sigma_{y12}^2}$$

The isotropic case of von Mises plasticity can be recovered by setting:

$$F = G = H = \frac{1}{2\sigma_y^2}$$

and

$$L = M = N = \frac{3}{2\sigma_y^2}$$

For the particular case of transverse anisotropy, where properties do not vary in the $x_1 - x_2$ plane, the following relations hold:

$$2F = 2G = \frac{1}{\sigma_{y3}^2}$$

$$2H = \frac{2}{\sigma_y^2} - \frac{1}{\sigma_{y3}^2}$$

$$N = \frac{2}{\sigma_y^2} - \frac{1}{2\sigma_{y3}^2}$$

where it has been assumed that $\sigma_{y1} = \sigma_{y2} = \sigma_y$.

Letting $K = \sigma_y/\sigma_{y3}$, the yield criteria can be written as:

$$F(\sigma) = \sigma_e = \sigma_y ,$$

where

$$F(\sigma) \equiv \left[\sigma_{11}^2 + \sigma_{22}^2 + K^2\sigma_{33}^2 - K^2\sigma_{33}(\sigma_{11} + \sigma_{22}) - (2 - K^2)\sigma_{11}\sigma_{22} \right. \\ \left. + 2L\sigma_y^2(\sigma_{23}^2 + \sigma_{31}^2) + 2\left(2 - \frac{1}{2}K^2\right)\sigma_{12}^2 \right]^{1/2} .$$

The rate of plastic strain is assumed to be normal to the yield surface so $\dot{\epsilon}_{ij}^p$ is found from:

$$\dot{\epsilon}_{ij}^p = \lambda \frac{\partial F}{\partial \sigma_{ij}} .$$

Now consider the case of plane stress, where $\sigma_{33} = 0$. Also, define the anisotropy input parameter, R , as the ratio of the in-plane plastic strain rate to the out-of-plane plastic strain rate,

Time=0.010271, #nodes=4594, #elem=4349
Contours of % Thickness Reduction based on current z-strain
min=0.0093799, at elem#42249
max=22.1816, at elem#39875

Time=0.010271, #nodes=4594, #elem=4349
Contours of % Thickness Reduction based on current z-strain
min=0.0597092, at elem#39814
max=21.2252, at elem#40457

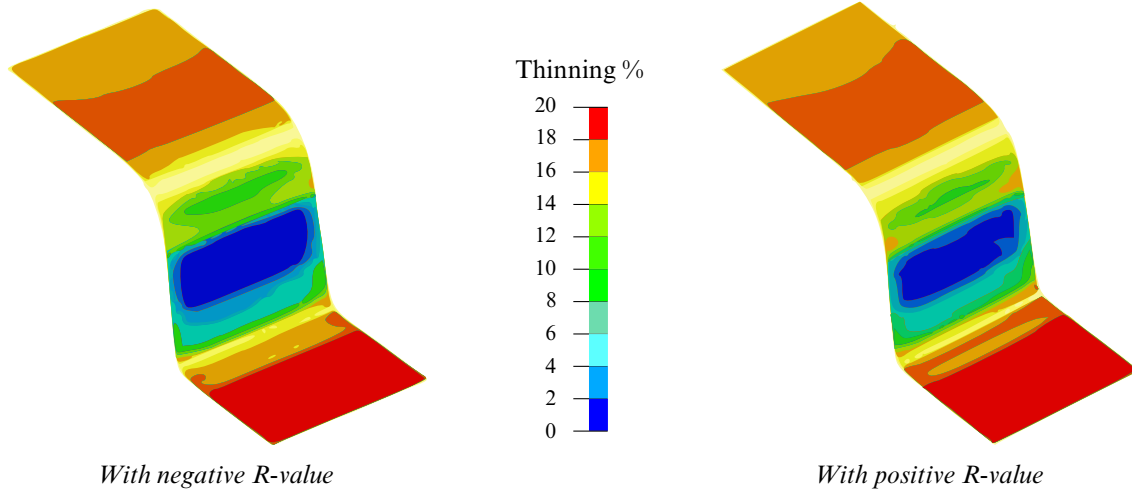

Figure M37-1. Thinning contour comparison.

$$R = \frac{\dot{\epsilon}_{22}^p}{\dot{\epsilon}_{33}^p} .$$

It then follows that

$$R = \frac{2}{K^2} - 1 .$$

Using the plane stress assumption and the definition of R , the yield function may now be written as:

$$F(\sigma) = \left[\sigma_{11}^2 + \sigma_{22}^2 - \frac{2R}{R+1} \sigma_{11} \sigma_{22} + 2 \frac{2R+1}{R+1} \sigma_{12}^2 \right]^{1/2} .$$

2. **Anisotropic Parameter R.** When the R value is set to a negative value, it stabilizes the sheet thickness or thinning in sheet metal forming for some high strength types of steel or in cases where the simulation time is long. In [Figure M37-1](#), a comparison of thinning contours is shown on a U-channel forming (one-half model) using negative and positive R values. Maximum thinning on the draw wall is slight higher in the negative R case than that in the positive R case.
3. **Comparison to other Material Models.** There are several differences between this model and other plasticity models for shell elements such as the model, MAT_PIECEWISE_LINEAR_PLASTICITY. First, the yield function for plane stress does not include the transverse shear stress components which are updated elastically, and, secondly, this model is always fully iterative. Consequently, in comparing results for the isotropic case where $R = 1.0$ with other

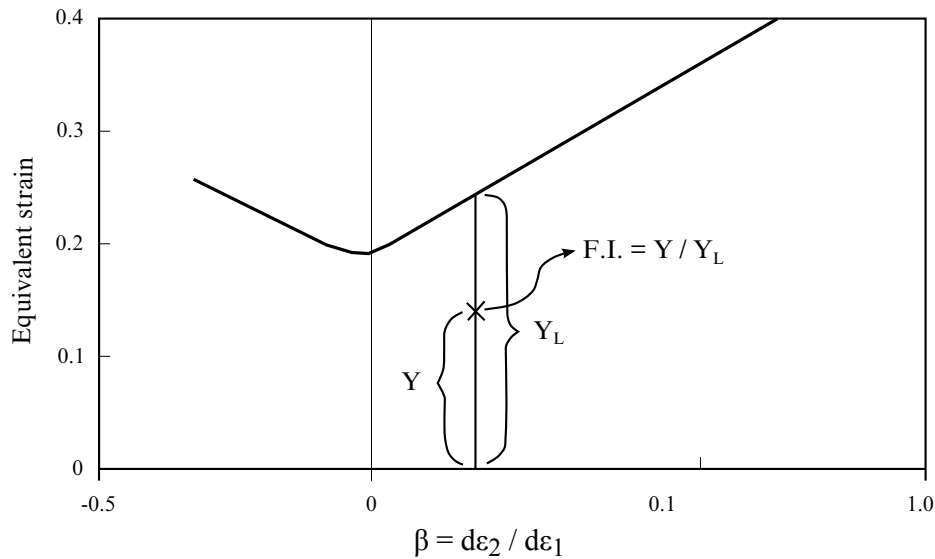

Figure M37-2. Calculation of F.I. based on critical equivalent strain method.

isotropic model, differences in the results are expected, even though they are usually insignificant.

4. **ECHANGE.** The Young's modulus has been assumed to be constant. However, some researchers have found that Young's modulus decreases with respect to the increase of effective plastic strain. To accommodate this new observation, a new option of ECHANGE is added. There are two methods defining the change of Young's modulus change:

The first method is to use a curve to define the scale factor with respect to the effective plastic strain. The value of this scale factor should decrease from 1.0 to 0.0 with the increase of effective plastic strain.

The second method is to use a function as proposed by Yoshida [2003]:

$$E = E^0 - (E^0 - E^A)[1 - \exp(-\zeta\bar{\epsilon})].$$

An example of the option ECHANGE is provided in the Remarks section of the *MAT_125 manual pages.

5. **Nonlinear Strain Paths.** When the keyword option NLP_FAILURE is used, a necking failure criterion independent of strain path changes is activated. In sheet metal forming, as strain path history (plotted on in-plane major and minor strain space) of an element becomes non-linear, the position and shape of a traditional strain-based Forming Limit Diagram (FLD) changes. This option provides a simple formability index (F.I.) which remains invariant regardless of the presence of the non-linear strain paths in the model and can be used to identify if the element has reached its necking limit.

Formability index (F.I) is calculated, as illustrated in [Figure M37-2](#), for every element in the sheet blank throughout the simulation duration. The value of F.I. is 0.0 for virgin material and reaches maximum of 1.0 when the material fails. The theoretical background can be found in two papers: 1) *T.B. Stoughton, X. Zhu, "Review of Theoretical Models of the Strain-Based FLD and their Relevance to the Stress-Based FLD, International Journal of Plasticity", V. 20, Issues 8-9, P. 1463-1486, 2003;* and 2) *Danielle Zeng, Xinhai Zhu, Laurent B. Chappuis, Z. Cedric Xia, "A Path Independent Forming Limited Criterion for Sheet Metal Forming Simulations", 2008 SAE Proceedings, Detroit MI, April, 2008.*

6. **ICFLD.** The load curve input for ICFLD follows keyword format in *DEFINE_CURVE, with abscissas as minor strains and ordinates as major strains.

ICFLD can also be specified using the *DEFINE_CURVE FLC keyword where the sheet metal thickness and strain hardening value are used. Detailed usage information can be found in the manual entry for *DEFINE_CURVE FLC.

7. **Formability Index Output.** The formability index is output as a history variable #1 in d3plot files. In addition to the F.I. values, starting in Revision 95599, the strain ratio β and effective plastic strain $\bar{\epsilon}$ are written to the d3plot database as history variables #2 and #3, respectively provided NEIPS on the second field of the first card of *DATABASE_EXTENT_BINARY is set to at least 3. The contour map of history variables can be plotted in LS-PrePost, accessible in *Post/FriComp*, under *Misc*, and by *Element*, under *Post/History*. It is suggested that variable MAXINT in *DATABASE_EXTENT_BINARY be set to the same value of as the NIP field for the *SECTION_SHELL keyword.
8. **STRAINLT.** By setting the STRAINLT field strains (and strain ratios) can be averaged to reduce noise, which, in turn, affect the calculation of the formability index. The strain STRAINLT causes the formability index calculation to use only time averaged strains. Reasonable STRAINLT values range from 5×10^{-3} to 10^{-2} .

*MAT_BLATZ-KO_FOAM

This is Material Type 38. This model is for the definition of rubber like foams of polyurethane. It is a simple one-parameter model with a fixed Poisson's ratio of .25.

Card 1	1	2	3	4	5	6	7	8
Variable	MID	RO	G	REF				
Type	A	F	F	F				

VARIABLE**DESCRIPTION**

MID	Material identification. A unique number or label must be specified (see *PART).
RO	Mass density
G	Shear modulus
REF	Use reference geometry to initialize the stress tensor. The reference geometry is defined by the keyword: *INITIAL_FOAM_REFERENCE_GEOMETRY. EQ.0.0: off EQ.1.0: on

Remarks:

The strain energy functional for the compressible foam model is given by

$$W = \frac{G}{2} \left(\frac{\text{II}}{\text{III}} + 2\sqrt{\text{III}} - 5 \right) .$$

Blatz and Ko [1962] suggested this form for a 47 percent volume polyurethane foam rubber with a Poisson's ratio of 0.25. In terms of the strain invariants, I, II, and III, the second Piola-Kirchhoff stresses are given as

$$S^{ij} = G \left[(I\delta_{ij} - C_{ij}) \frac{1}{\text{III}} + \left(\sqrt{\text{III}} - \frac{\text{II}}{\text{III}} \right) C_{ij}^{-1} \right] ,$$

where C_{ij} is the right Cauchy-Green strain tensor. This stress measure is transformed to the Cauchy stress, σ_{ij} , according to the relationship

$$\sigma^{ij} = \text{III}^{-1/2} F_{ik} F_{jl} S_{lk} ,$$

where F_{ij} is the deformation gradient tensor.

***MAT_FLD_TRANSVERSELY_ANISOTROPIC**

This is Material Type 39. This model is for simulating sheet forming processes with anisotropic material. Only transverse anisotropy can be considered. Optionally, an arbitrary dependency of stress and effective plastic strain can be defined using a load curve. A Forming Limit Diagram (FLD) can be defined using a curve and is used to compute the maximum strain ratio which can be plotted in LS-PrePost. This plasticity model is fully iterative and is available only for shell elements. Also see the Remarks below.

Card 1	1	2	3	4	5	6	7	8
Variable	MID	RO	E	PR	SIGY	ETAN	R	HLCID
Type	A	F	F	F	F	F	F	F

Card 2	1	2	3	4	5	6	7	8
Variable	LCFLD							
Type	F							

VARIABLE**DESCRIPTION**

MID	Material identification. A unique number or label must be specified (see *PART).
RO	Mass density
E	Young's modulus
PR	Poisson's ratio
SIGY	Yield stress
ETAN	Plastic hardening modulus; see Remarks for MAT 37.
R	Anisotropic hardening parameter; see Remarks for MAT 37.
HLCID	Load curve ID defining effective stress as a function of effective plastic strain. The yield stress and hardening modulus are ignored with this option.

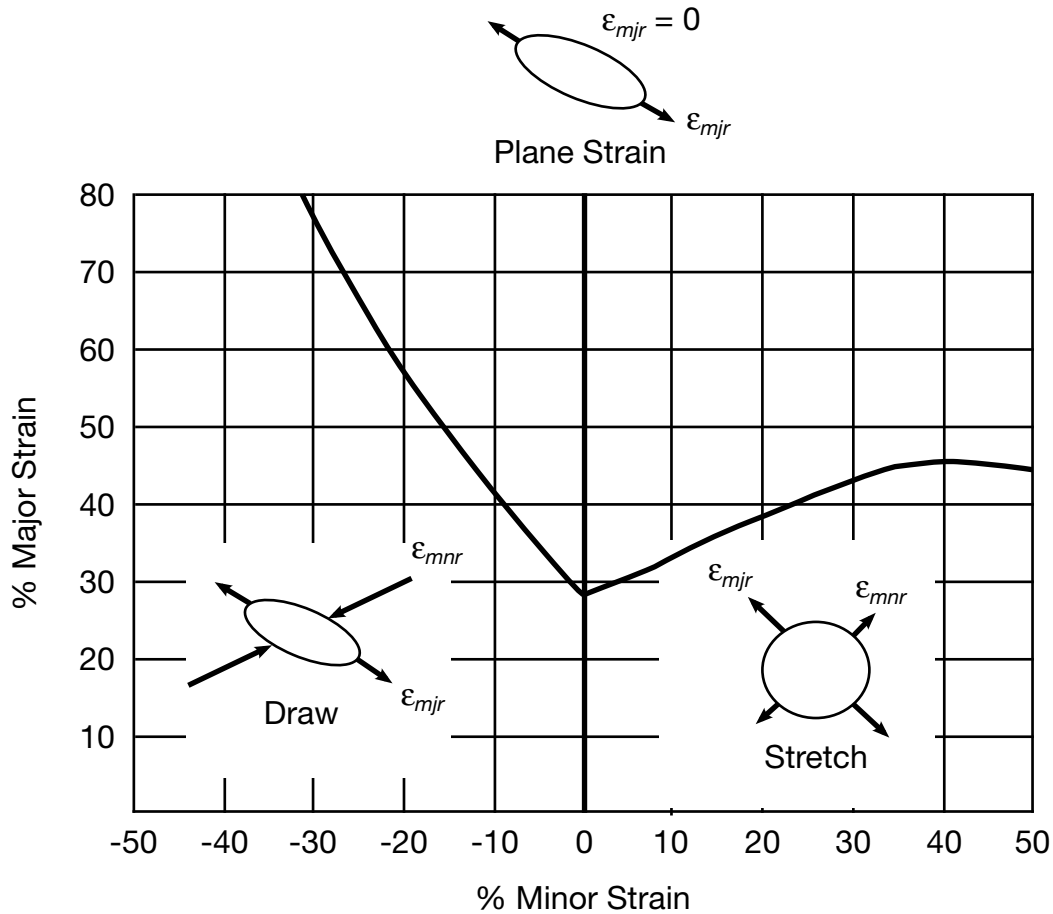

Figure M39-1. Forming limit diagram.

VARIABLE	DESCRIPTION
LCFLD	Load curve ID defining the Forming Limit Diagram. Minor strains in percent are defined as abscissa values and major strains in percent are defined as ordinate values. The forming limit diagram is shown in Figure M39-1. In defining the curve list pairs of minor and major strains starting with the left most point and ending with the right most point; see *DEFINE_CURVE.

Remarks:

See material model 37 for the theoretical basis. The first history variable is the maximum strain ratio:

$$\frac{\epsilon_{\text{major_workpiece}}}{\epsilon_{\text{major_fld}}}$$

corresponding to $\epsilon_{\text{minor_workpiece}}$.

*MAT_NONLINEAR_ORTHOTROPIC

This is Material Type 40. This model allows the definition of an orthotropic nonlinear elastic material based on a finite strain formulation with the initial geometry as the reference. Failure is optional with two failure criteria available. Optionally, stiffness proportional damping can be defined. In the stress initialization phase, temperatures can be varied to impose the initial stresses. This model is only available for shell elements, solid elements, and thick shell formulations 3, 5, and 7.

WARNING: We do not recommend using this model at this time since it can be unstable especially if the stress-strain curves increase in stiffness with increasing strain.

Card 1	1	2	3	4	5	6	7	8
Variable	MID	R0	EA	EB	EC	PRBA	PRCA	PRCB
Type	A	F	F	F	F	F	F	F
Default	none	none	none	none	none	none	none	none

Card 2	1	2	3	4	5	6	7	8
Variable	GAB	GBC	GCA	DT	TRAMP	ALPHA		
Type	F	F	F	F	F	F		
Default	none	none	none	0.0	0.0	0.0		

MAT_040**MAT_NONLINEAR_ORTHOTROPIC**

Card 3	1	2	3	4	5	6	7	8
Variable	LCIDA	LCIDB	EFAIL	DFAIL	CDAMP	AOPT	MACF	ATRACK
Type	F	F	F	F	F	F	I	I
Default	0.0	0.0	0.0	0.0	0.0	0.0	0	0

Card 4	1	2	3	4	5	6	7	8
Variable	XP	YP	ZP	A1	A2	A3		
Type	F	F	F	F	F	F		

Card 5	1	2	3	4	5	6	7	8
Variable	V1	V2	V3	D1	D2	D3	BETA	
Type	F	F	F	F	F	F	F	

Optional Card 6 (Applies to solid elements only)

Card 6	1	2	3	4	5	6	7	8
Variable	LCIDC	LCIDAB	LCIDBC	LCIDCA				
Type	F	F	F	F				
Default	optional	optional	optional	optional				

VARIABLE**DESCRIPTION**

MID	Material identification. A unique number or label must be specified (see *PART).
RO	Mass density.

VARIABLE	DESCRIPTION
EA	E_a , Young's modulus in a -direction.
EB	E_b , Young's modulus in b -direction.
EC	E_c , Young's modulus in c -direction.
PRBA	ν_{ba} , Poisson's ratio ba .
PRCA	ν_{ca} , Poisson's ratio ca .
PRCB	ν_{cb} , Poisson's ratio cb .
GAB	G_{ab} , shear modulus ab .
GBC	G_{bc} , shear modulus bc .
GCA	G_{ca} , shear modulus ca .
DT	Temperature increment for isotropic stress initialization. This option can be used during dynamic relaxation.
TRAMP	Time to ramp up to the final temperature.
ALPHA	Thermal expansion coefficient.
LCIDA	Optional load curve ID defining the nominal stress versus strain along a -axis. Strain is defined as $\lambda_a - 1$ where λ_a is the stretch ratio along the a -axis.
LCIDB	Optional load curve ID defining the nominal stress versus strain along b -axis. Strain is defined as $\lambda_b - 1$ where λ_b is the stretch ratio along the b -axis.
EFAIL	Failure strain, $\lambda - 1$.
DFAIL	Time step for automatic element erosion
CDAMP	Damping coefficient.
AOPT	Material axes option (see MAT_OPTIONTROPIC_ELASTIC, particularly the Material Directions section, for details):

VARIABLE	DESCRIPTION
EQ.0.0:	Locally orthotropic with material axes determined by element nodes 1, 2, and 4, as with *DEFINE_COORDINATE_NODES. For shells only, the material axes are then rotated about the normal vector to the surface of the shell by the angle BETA.
EQ.1.0:	Locally orthotropic with material axes determined by a point, P , in space and the global location of the element center; this is the a -direction. This option is for solid elements only.
EQ.2.0:	Globally orthotropic with material axes determined by vectors defined below, as with *DEFINE_COORDINATE_VECTOR
EQ.3.0:	Locally orthotropic material axes determined by a vector \mathbf{v} and the normal vector to the plane of the element. The plane of a solid element is the midsurface between the inner surface and outer surface defined by the first four nodes and the last four nodes of the connectivity of the element, respectively. Thus, for solid elements, AOPT = 3 is only available for hexahedrons. a is determined by taking the cross product of \mathbf{v} with the normal vector, b is determined by taking the cross product of the normal vector with a , and c is the normal vector. Then a and b are rotated about c by an angle BETA. BETA may be set in the keyword input for the element or in the input for this keyword. Note that for solids, the material axes may be switched depending on the choice of MACF. The switch may occur before or after applying BETA depending on the value of MACF.
EQ.4.0:	Locally orthotropic in a cylindrical coordinate system with the material axes determined by a vector \mathbf{v} , and an originating point, P , which define the centerline axis. This option is for solid elements only.
LT.0.0:	The absolute value of AOPT is a coordinate system ID number (CID on *DEFINE_COORDINATE_OPTION).

VARIABLE	DESCRIPTION
MACF	<p>Material axes change flag for solid elements:</p> <p>EQ.-4: Switch material axes b and c before BETA rotation</p> <p>EQ.-3: Switch material axes a and c before BETA rotation</p> <p>EQ.-2: Switch material axes a and b before BETA rotation</p> <p>EQ.1: No change, default</p> <p>EQ.2: Switch material axes a and b after BETA rotation</p> <p>EQ.3: Switch material axes a and c after BETA rotation</p> <p>EQ.4: Switch material axes b and c after BETA rotation</p> <p>Figure M2-2 indicates when LS-DYNA applies MACF during the process to obtain the final material axes. If BETA on *ELEMENT_SOLID_{OPTION} is defined, then that BETA is used for the rotation for all AOPT options. Otherwise, if AOPT = 3, the BETA input on Card 5 rotates the axes. For all other values of AOPT, the material axes will be switched as specified by MACF, but no BETA rotation will be performed.</p>
ATRACK	<p>Material a-axis tracking flag (shell elements only)</p> <p>EQ.0: a-axis rotates with element (default)</p> <p>EQ.1: a-axis also tracks deformation</p>
XP, YP, ZP	Define coordinates of point p for AOPT = 1 and 4.
A1, A2, A3	(a_1, a_2, a_3) define components of vector \mathbf{a} for AOPT = 2.
D1, D2, D3	(d_1, d_2, d_3) define components of vector \mathbf{d} for AOPT = 2.
V1, V2, V3	(v_1, v_2, v_3) define components of vector \mathbf{v} for AOPT = 3 and 4.
BETA	Material angle in degrees for AOPT = 0 (shells and thick shells only) and AOPT = 3. BETA may be overridden on the element card, see *ELEMENT_SHELL_BETA, *ELEMENT_TSHELL_BETA, and *ELEMENT_SOLID_ORTHO.
LCIDC	Load curve ID defining the nominal stress versus strain along c -axis. Strain is defined as $\lambda_c - 1$ where λ_c is the stretch ratio along the c -axis.
LCIDAB	Load curve ID defining the nominal ab shear stress versus ab -strain in the ab -plane. Strain is defined as the $\sin(\gamma_{ab})$ where γ_{ab} is the shear angle.

VARIABLE	DESCRIPTION
LCIDBC	Load curve ID defining the nominal <i>bc</i> shear stress versus <i>bc</i> -strain in the <i>bc</i> -plane. Strain is defined as the $\sin(\gamma_{bc})$ where γ_{bc} is the shear angle.
LCIDCA	Load curve ID defining the nominal <i>ca</i> shear stress versus <i>ca</i> -strain in the <i>ca</i> -plane. Strain is defined as the $\sin(\gamma_{ca})$ where γ_{ca} is the shear angle.

Remarks:

1. **The ATRACK Field.** The initial material directions are set using AOPT and the related data. By default, the material directions in shell elements are updated each cycle based on the rotation of the 1-2 edge, or else the rotation of all edges if the invariant node numbering option is set on *CONTROL_ACCURACY. When ATRACK=1, an optional scheme is used in which the *a*-direction of the material tracks element deformation as well as rotation. For more information, see Remark 2 of *MAT_COMPOSITE_DAMAGE.
2. **Computing Stresses.** The stress versus stretch curves LCIDA, LCIDB, LCIDC, LCIDAB, LCIDBC, and LCIDCA are only used to obtain the slope (stiffness) to fill up the |C| matrix and are not used directly to compute the stresses. The stresses are computed using the |C| matrix and the Green-St Venant strain tensor.

*MAT_USER_DEFINED_MATERIAL_MODELS

These are Material Types 41 - 50. The user must provide a material subroutine. See also Appendix A. This keyword input is used to define material properties for the subroutine. Isotropic, anisotropic, thermal, and hyperelastic material models with failure can be handled.

Card Summary:

Card 1. This card is required.

MID	RO	MT	LMC	NHV	IORTHO	IBULK	IG
-----	----	----	-----	-----	--------	-------	----

Card 2. This card is required.

IVECT	IFAIL	ITHERM	IHYPER	IEOS	LMCA		
-------	-------	--------	--------	------	------	--	--

Card 3. This card is included if and only if IORTHO = 1 or 3.

AOPT	MACF	XP	YP	ZP	A1	A2	A3
------	------	----	----	----	----	----	----

Card 4. This card is included if and only if IORTHO = 1 or 3.

V1	V2	V3	D1	D2	D3	BETA	IEVTS
----	----	----	----	----	----	------	-------

Card 5. Include as many of this card as required to define LMC fields.

P1	P2	P3	P4	P5	P6	P7	P8
----	----	----	----	----	----	----	----

Card 6. Include as many of this card as required to define LMCA fields.

P1	P2	P3	P4	P5	P6	P7	P8
----	----	----	----	----	----	----	----

Data Card Definitions:

Card 1	1	2	3	4	5	6	7	8
Variable	MID	RO	MT	LMC	NHV	IORTHO	IBULK	IG
Type	A	F	I	I	I	I	I	I

VARIABLE	DESCRIPTION
MID	Material identification. A unique number or label must be specified (see *PART).
RO	Mass density
MT	User material type (41 - 50 inclusive). A number between 41 and 50 must be chosen. If $MT < 0$, subroutine <code>rwumat</code> in <code>dyn21.f</code> is called, where the material parameter reading can be modified.
<div style="border: 1px solid black; padding: 5px;">WARNING: If two or more materials in an input deck share the same MT value, those materials must have the same values of other variables on Cards 1 and 2 except for MID and RO.</div>	
LMC	Length of material constant array which is equal to the number of material constants to be input. See Remark 2 .
NHV	Number of history variables to be stored; see Appendix A. When the model is to be used with an equation of state, NHV must be increased by 4 to allocate the storage required by the equation of state.
IORTHO/ ISPOT	Orthotropic/spot weld thinning flag: EQ.0: If the material is not orthotropic and is not used with spot weld thinning EQ.1: If the material is orthotropic EQ.2: If material is used with spot weld thinning EQ.3: If material is orthotropic and used with spot weld thinning
IBULK	Address of bulk modulus in material constants array; see Appendix A.
IG	Address of shear modulus in material constants array; see Appendix A.

Card 2	1	2	3	4	5	6	7	8
Variable	IVECT	IFAIL	ITHERM	IHYPER	IEOS	LMCA		
Type	I	I	I	I	I	I		

VARIABLE**DESCRIPTION**

IVECT	<p>Vectorization flag:</p> <p>EQ.0: Off</p> <p>EQ.1: On. A vectorized user subroutine must be supplied.</p>
IFAIL	<p>Failure flag.</p> <p>EQ.0: No failure</p> <p>EQ.1: Allows failure of shell and solid elements</p> <p>LT.0: IFAIL is the address of NUMINT in the material constants array. NUMINT is defined as the number of failed integration points that will trigger element deletion. This option applies only to shell and solid elements (release 5 of version 971).</p>
ITHERM	<p>Temperature flag:</p> <p>EQ.0: Off</p> <p>EQ.1: On. Compute element temperature.</p>
IHYPER	<p>Deformation gradient flag (see Appendix A):</p> <p>EQ.0: Do not compute deformation gradient.</p> <p>EQ.-1: Same as 1, except if IORTHO = 1 or 3, the deformation gradient is in the global coordinate system.</p> <p>EQ.-10: Same as -1, except that this will enforce full integration for elements -1, -2 and 2.</p> <p>EQ.1: Compute deformation gradient for bricks and shells. If IORTHO = 1 or 3, the deformation gradient is in the local coordinate system instead of the global coordinate system.</p> <p>EQ.10: Same as 1, except that this will enforce full integration for elements -1, -2 and 2.</p>

VARIABLE	DESCRIPTION
	EQ.3: Compute deformation gradient for shells from the nodal coordinates in the global coordinate system.
IEOS	Equation of state flag: EQ.0: Off EQ.1: On
LMCA	Length of additional material constant array

Orthotropic Card 1. Additional card for IORTHO = 1 or 3.

Card 3	1	2	3	4	5	6	7	8
Variable	AOPT	MACF	XP	YP	ZP	A1	A2	A3
Type	F	I	F	F	F	F	F	F

VARIABLE	DESCRIPTION
AOPT	<p>Material axes option (see *MAT_002 for a more complete description):</p> <p>EQ.0.0: Locally orthotropic with material axes determined by element nodes 1, 2, and 4, as with *DEFINE_COORDINATE_NODES, and then, for shells only, rotated about the shell element normal by an angle BETA</p> <p>EQ.1.0: Locally orthotropic with material axes determined by a point in space and the global location of the element center; this is the <i>a</i>-direction. This option is for solid elements only.</p> <p>EQ.2.0: Globally orthotropic with material axes determined by vectors defined below, as with *DEFINE_COORDINATE_VECTOR.</p> <p>EQ.3.0: Locally orthotropic material axes determined by rotating the material axes about the element normal by an angle, BETA, from a line in the plane of the element defined by the cross product of the vector <i>v</i> with the element normal.</p>

VARIABLE	DESCRIPTION
	EQ.4.0: Locally orthotropic in cylindrical coordinate system with the material axes determined by a vector \mathbf{v} , and an originating point, p , which define the centerline axis. This option is for solid elements only.
	LT.0.0: The absolute value of AOPT is a coordinate system ID number (CID on *DEFINE_COORDINATE_NODES, *DEFINE_COORDINATE_SYSTEM or *DEFINE_COORDINATE_VECTOR). Available in R3 version of 971 and later.
MACF	Material axes change flag for brick elements for quick changes: EQ.1: No change, default EQ.2: Switch material axes a and b EQ.3: Switch material axes a and c EQ.4: Switch material axes b and c
XP, YP, ZP	Coordinates of point p for AOPT = 1 and 4
A1, A2, A3	Components of vector \mathbf{a} for AOPT = 2

Orthotropic Card 2. Additional card for IORTHO = 1 or 3.

Card 4	1	2	3	4	5	6	7	8
Variable	V1	V2	V3	D1	D2	D3	BETA	IEVTS
Type	F	F	F	F	F	F	F	I

VARIABLE	DESCRIPTION
V1, V2, V3	Components of vector \mathbf{v} for AOPT = 3 and 4
D1, D2, D3	Components of vector \mathbf{d} for AOPT = 2
BETA	Material angle in degrees for AOPT = 0 (shells only) and AOPT = 3. BETA may be overridden on the element card; see *ELEMENT_SHELL_BETA and *ELEMENT_SOLID_ORTHO.
IEVTS	Address of E_a for orthotropic material with thick shell formulation 5 (see Remark 4)

Define LMC material parameters using 8 parameters per card. See [Remark 2](#).

Card 5	1	2	3	4	5	6	7	8
Variable	P1	P2	P3	P4	P5	P6	P7	P8
Type	F	F	F	F	F	F	F	F

Define LMCA material parameters using 8 parameters per card.

Card 6	1	2	3	4	5	6	7	8
Variable	P1	P2	P3	P4	P5	P6	P7	P8
Type	F	F	F	F	F	F	F	F

VARIABLE**DESCRIPTION**

P1	First material parameter.
P2	Second material parameter.
P3	Third material parameter.
P4	Fourth material parameter.
⋮	⋮
PLMC	LMC th material parameter.

Remarks:

1. **Cohesive Elements.** Material models for the cohesive element (solid element type 19) uses the first two *material parameters* to set flags in the *element formulation*.
 - a) *P1*. The P1 field controls how the density is used to calculate the mass when determining the tractions at mid-surface (tractions are calculated on a surface midway between the surfaces defined by nodes 1-2-3-4 and 5-6-7-8). If P1 is set to 1.0, then the density is per unit area of the mid-surface instead of per unit volume. Note that the cohesive element formulation permits the element to have zero or negative volume.

- b) *P2*. The second parameter, *P2*, specifies the number of integration points (one to four) that are required to fail for the element to fail. If it is zero, the element will not fail regardless of *IFAIL*. The recommended value for *P2* is 1.
 - c) *Other Parameters*. The cohesive element only uses *MID*, *RO*, *MT*, *LMC*, *NHV*, *IFAIL* and *IVECT* in addition to the material parameters.
 - d) *Appendix R*. See Appendix R for the specifics of the *umat* subroutine requirements for the cohesive element.
2. **Material Constants**. If *IORTHO* = 0, *LMC* must be ≤ 48 . If *IORTHO* = 1, *LMC* must be ≤ 40 . If more material constants are needed, *LMCA* may be used to create an additional material constant array. There is no limit on the size of *LMCA*.
 3. **Spot weld thinning**. If the user-defined material is used for beam or brick element spot welds that are tied to shell elements, and *SPOTHIN* > 0 on **CONTROL_CONTACT*, then spot weld thinning will be done for those shells if *ISPOT* = 2. Otherwise, it will not be done.
 4. **Thick Shell Formulation 5**. *IEVTS* is optional and is used only by thick shell formulation 5. It points to the position of E_a in the material constants array. Following E_a , the next 5 material constants must be E_b , E_c , ν_{ba} , ν_{ca} , and ν_{cb} . This data enables thick shell formulation 5 to calculate an accurate thickness strain, otherwise the thickness strain will be based on the elastic constants pointed to by *IBULK* and *IG*.

***MAT_BAMMAN**

This is Material Type 51. It allows the modeling of temperature and rate dependent plasticity with a fairly complex model that has many input parameters [Bammann 1989].

Card 1	1	2	3	4	5	6	7	8
Variable	MID	RO	E	PR	T	HC		
Type	A	F	F	F	F	F		

Card 2	1	2	3	4	5	6	7	8
Variable	C1	C2	C3	C4	C5	C6	C7	C8
Type	F	F	F	F	F	F	F	F

Card 3	1	2	3	4	5	6	7	8
Variable	C9	C10	C11	C12	C13	C14	C15	C16
Type	F	F	F	F	F	F	F	F

Card 4	1	2	3	4	5	6	7	8
Variable	C17	C18	A1	A2	A4	A5	A6	KAPPA
Type	F	F	F	F	F	F	F	F

VARIABLE**DESCRIPTION**

MID	Material identification. A unique number or label must be specified (see *PART).
RO	Mass density
E	Young's modulus (psi)

VARIABLE	DESCRIPTION
PR	Poisson's ratio
T	Initial temperature (°R, degrees Rankine)
HC	Heat generation coefficient (°R/psi)
C1	psi
C2	°R
C3	psi
C4	°R
C5	s ⁻¹
C6	°R
C7	1/psi
C8	°R
C9	psi
C10	°R
C11	1/psi-s
C12	°R
C13	1/psi
C14	°R
C15	psi
C16	°R
C17	1/psi-s
C18	°R
A1	α_1 , initial value of internal state variable 1
A2	α_2 , initial value of internal state variable 2. Note: $\alpha_3 = -(\alpha_1 + \alpha_2)$
A4	α_4 , initial value of internal state variable 3

VARIABLE	DESCRIPTION
A5	α_5 , initial value of internal state variable 4
A6	α_6 , initial value of internal state variable 5
KAPPA	κ , initial value of internal state variable 6

Unit Conversion Table

sec × psi × °R	sec × MPa × °R	sec × MPa × °K
C ₁	× 1/145	× 1/145
C ₂	—	× 5/9
C ₃	× 1/145	× 1/145
C ₄	—	× 5/9
C ₅	—	—
C ₆	—	× 5/9
C ₇	× 145	× 145
C ₈	—	× 5/9
C ₉	× 1/145	× 1/145
C ₁₀	—	× 5/9
C ₁₁	× 145	× 145
C ₁₂	—	× 5/9
C ₁₃	× 145	× 145
C ₁₄	—	× 5/9
C ₁₅	× 1/145	× 1/145
C ₁₆	—	× 5/9
C ₁₇	× 145	× 145
C ₁₈	—	× 5/9
C0 = HC	× 145	× (145) ^(5/9)
E	× 1/145	× 1/145
ν	—	—
T	—	× 5/9

Remarks:

The kinematics associated with the model are discussed in references [Hill 1948, Bammann and Aifantis 1987, Bammann 1989]. The description below is taken nearly verbatim from Bammann [1989].

With the assumption of linear elasticity, we can write:

$$\overset{\circ}{\sigma} = \lambda \operatorname{tr}(\mathbf{D}^e) \mathbf{1} + 2\mu \mathbf{D}^e ,$$

where the Cauchy stress σ is convected with the elastic spin \mathbf{W}^e as,

$$\overset{\circ}{\sigma} = \dot{\sigma} - \mathbf{W}^e \sigma + \sigma \mathbf{W}^e .$$

This is equivalent to writing the constitutive model with respect to a set of directors whose direction is defined by the plastic deformation [Bammann and Aifantis 1987, Bammann and Johnson 1987]. Decomposing both the skew symmetric and symmetric parts of the velocity gradient into elastic and plastic parts, we write for the elastic stretching \mathbf{D}^e and the elastic spin \mathbf{W}^e ,

$$\mathbf{D}^e = \mathbf{D} - \mathbf{D}^p - \mathbf{D}^{th}, \quad \mathbf{W}^e = \mathbf{W} = \mathbf{W}^p .$$

Within this structure it is now necessary to prescribe an equation for the plastic spin \mathbf{W}^p in addition to the normally prescribed flow rule for \mathbf{D}^p and the stretching due to the thermal expansion \mathbf{D}^{th} . As proposed, we assume a flow rule of the form,

$$\mathbf{D}^p = f(T) \sinh \left[\frac{|\boldsymbol{\zeta}'| - \kappa - Y(T)}{V(T)} \right] \frac{\boldsymbol{\zeta}'}{|\boldsymbol{\zeta}'|} .$$

where T is the temperature, κ is the scalar hardening variable, and $\boldsymbol{\zeta}'$ is the difference between the deviatoric Cauchy stress $\boldsymbol{\sigma}'$ and the tensor variable $\boldsymbol{\alpha}'$,

$$\boldsymbol{\zeta}' = \boldsymbol{\sigma}' - \boldsymbol{\alpha}' ,$$

and $f(T)$, $Y(T)$, and $V(T)$ are scalar functions whose specific dependence upon the temperature is given below. Assuming isotropic thermal expansion and introducing the expansion coefficient \dot{A} , the thermal stretching can be written,

$$\mathbf{D}^{th} = \dot{A} \mathbf{1}$$

The evolution of the internal variables $\boldsymbol{\alpha}$ and κ are prescribed in a hardening minus recovery format as,

$$\begin{aligned} \dot{\boldsymbol{\alpha}} &= h(T) \mathbf{D}^p - [r_d(T) |\mathbf{D}^p| + r_s(T)] |\boldsymbol{\alpha}| \boldsymbol{\alpha} \\ \dot{\kappa} &= H(T) \mathbf{D}^p - [R_d(T) |\mathbf{D}^p| + R_s(T)] \kappa^2 \end{aligned}$$

where h and H are the hardening moduli, $r_s(T)$ and $R_s(T)$ are scalar functions describing the diffusion controlled 'static' or 'thermal' recovery, and $r_d(T)$ and $R_d(T)$ are the functions describing dynamic recovery.

If we assume that $\mathbf{W}^p = 0$, we recover the Jaumann stress rate which results in the prediction of an oscillatory shear stress response in simple shear when coupled with a Prager kinematic hardening assumption [Johnson and Bammann 1984]. Alternatively, we can choose,

$$\mathbf{W}^p = \mathbf{R}^T \dot{\mathbf{U}} \mathbf{U}^{-1} \mathbf{R},$$

which recovers the Green-Naghdi rate of Cauchy stress and has been shown to be equivalent to Mandel's isoclinic state [Bammann and Aifantis 1987]. The model employing this

rate allows a reasonable prediction of directional softening for some materials, but in general under-predicts the softening and does not accurately predict the axial stresses which occur in the torsion of the thin walled tube.

The final equation necessary to complete our description of high strain rate deformation is one which allows us to compute the temperature change during the deformation. In the absence of a coupled thermo-mechanical finite element code we assume adiabatic temperature change and follow the empirical assumption that 90 - 95% of the plastic work is dissipated as heat. Hence,

$$\dot{T} = \frac{.9}{\rho C_v} (\sigma \cdot \mathbf{D}^p),$$

where ρ is the density of the material and C_v is the specific heat.

In terms of the input parameters, the functions defined above become:

$$\begin{aligned} V(T) &= C1 \exp(-C2/T) & r_s(T) &= C11 \exp(-C12/T) \\ Y(T) &= C3 \exp(C4/T) & R_d(T) &= C13 \exp(-C14/T) \\ f(T) &= C5 \exp(-C6/T) & H(T) &= C15 \exp(C16/T) \\ r_d(T) &= C7 \exp(-C8/T) & R_s(T) &= C17 \exp(-C18/T) \\ h(T) &= C9 \exp(C10/T) \end{aligned}$$

and the heat generation coefficient is

$$HC = \frac{0.9}{\rho C_v}.$$

***MAT_BAMMAN_DAMAGE**

This is Material Type 52. This is an extension of model 51 which includes the modeling of damage. See Bamman et al. [1990].

Card 1	1	2	3	4	5	6	7	8
Variable	MID	RO	E	PR	T	HC		
Type	A	F	F	F	F	F		

Card 2	1	2	3	4	5	6	7	8
Variable	C1	C2	C3	C4	C5	C6	C7	C8
Type	F	F	F	F	F	F	F	F

Card 3	1	2	3	4	5	6	7	8
Variable	C9	C10	C11	C12	C13	C14	C15	C16
Type	F	F	F	F	F	F	F	F

Card 4	1	2	3	4	5	6	7	8
Variable	C17	C18	A1	A2	A3	A4	A5	A6
Type	F	F	F	F	F	F	F	F

Card 5	1	2	3	4	5	6	7	8
Variable	N	D0	FS					
Type	F	F	F					

VARIABLE	DESCRIPTION
MID	Material identification. A unique number or label must be specified (see *PART).
RO	Mass density
E	Young's modulus (psi)
PR	Poisson's ratio
T	Initial temperature (°R, degrees Rankine)
HC	Heat generation coefficient ($^{\circ}\text{R}_{\text{psi}}$)
C1	Psi
C2	°R
C3	Psi
C4	°R
C5	1/s
C6	°R
C7	1/psi
C8	°R
C9	Psi
C10	°R
C11	1/psi-s
C12	°R
C13	1/psi
C14	°R
C15	psi
C16	°R

VARIABLE	DESCRIPTION
C17	1/psi-s
C18	°R
A1	α_1 , initial value of internal state variable 1
A2	α_2 , initial value of internal state variable 2
A3	α_3 , initial value of internal state variable 3
A4	α_4 , initial value of internal state variable 4
A5	α_5 , initial value of internal state variable 5
A6	α_6 , initial value of internal state variable 6
N	Exponent in damage evolution
D0	Initial damage (porosity)
FS	Failure strain for erosion

Remarks:

The evolution of the damage parameter, ϕ is defined by Bammann et al. [1990]

$$\dot{\phi} = \beta \left[\frac{1}{(1 - \phi)^N} - (1 - \phi) \right]^{|D^p|}$$

in which

$$\beta = \sinh \left[\frac{2(2N - 1)p}{(2N - 1)\bar{\sigma}} \right],$$

where p is the pressure and $\bar{\sigma}$ is the effective stress.

***MAT_CLOSED_CELL_FOAM**

This is Material Type 53. This material models low density, closed cell polyurethane foam. It is for simulating impact limiters in automotive applications. The effect of the confined air pressure is included with the air being treated as an ideal gas. The general behavior is isotropic with uncoupled components of the stress tensor.

Card 1	1	2	3	4	5	6	7	8
Variable	MID	RO	E	A	B	C	P0	PHI
Type	A	F	F	F	F	F	F	F

Card 2	1	2	3	4	5	6	7	8
Variable	GAMMA0	LCID						
Type	F	I						

VARIABLE**DESCRIPTION**

MID	Material identification. A unique number or label must be specified (see *PART).
RO	Mass density
E	Young's modulus
A	a , factor for yield stress definition; see Remarks below.
B	b , factor for yield stress definition; see Remarks below.
C	c , factor for yield stress definition; see Remarks below.
P0	Initial foam pressure, p_0
PHI	Ratio of foam to polymer density, ϕ
GAMMA0	Initial volumetric strain, γ_0 . The default is zero.

VARIABLE	DESCRIPTION
LCID	Optional load curve defining the von Mises yield stress as a function of $-\gamma$. If the load curve ID is given, the yield stress is taken from the curve and the constants a , b , and c are not needed. The load curve is defined in the positive quadrant, that is, positive values of γ are defined as negative values on the abscissa.

Remarks:

A rigid, low density, closed cell, polyurethane foam model developed at Sandia Laboratories [Neilsen, Morgan and Krieg 1987] has been recently implemented for modeling impact limiters in automotive applications. A number of such foams were tested at Sandia and reasonable fits to the experimental data were obtained.

In some respects this model is similar to the crushable honeycomb model type 26 in that the components of the stress tensor are uncoupled until full volumetric compaction is achieved. However, unlike the honeycomb model this material possesses no directionality but includes the effects of confined air pressure in its overall response characteristics.

$$\sigma_{ij} = \sigma_{ij}^{\text{sk}} - \delta_{ij} \sigma^{\text{air}} ,$$

where σ_{ij}^{sk} is the skeletal stress and σ^{air} is the air pressure. σ^{air} is computed from the equation:

$$\sigma^{\text{air}} = -\frac{p_0 \gamma}{1 + \gamma - \phi} ,$$

where p_0 is the initial foam pressure, usually taken as the atmospheric pressure, and γ defines the volumetric strain

$$\gamma = V - 1 + \gamma_0 .$$

Here, V is the relative volume, defined as the ratio of the current volume to the initial volume, and γ_0 is the initial volumetric strain, which is typically zero. The yield condition is applied to the principal skeletal stresses, which are updated independently of the air pressure. We first obtain the skeletal stresses:

$$\sigma_{ij}^{\text{sk}} = \sigma_{ij} + \sigma_{ij} \sigma^{\text{air}}$$

and compute the trial stress, σ_{ij}^{skt}

$$\sigma_{ij}^{\text{skt}} = \sigma_{ij}^{\text{sk}} + E \dot{\epsilon}_{ij} \Delta t ,$$

where E is Young's modulus. Since Poisson's ratio is zero, the update of each stress component is uncoupled and $2G = E$ where G is the shear modulus. The yield condition is applied to the principal skeletal stresses such that, if the magnitude of a principal trial stress component, σ_i^{skt} , exceeds the yield stress, σ_y , then

$$\sigma_i^{\text{sk}} = \min(\sigma_y, |\sigma_i^{\text{skt}}|) \frac{\sigma_i^{\text{skt}}}{|\sigma_i^{\text{skt}}|} .$$

The yield stress is defined by

$$\sigma_y = a + b(1 + c\gamma) ,$$

where a , b , and c are user defined input constants and γ is the volumetric strain as defined above. After scaling the principal stresses they are transformed back into the global system and the final stress state is computed

$$\sigma_{ij} = \sigma_{ij}^{\text{sk}} - \delta_{ij}\sigma^{\text{air}} .$$

*MAT_ENHANCED_COMPOSITE_DAMAGE

These are Material Types 54 - 55 which are enhanced versions of the composite model material type 22. Arbitrary orthotropic materials, such as unidirectional layers in composite shell structures, can be defined. Optionally, various types of failure can be specified following either the suggestions of [Chang and Chang 1987b] or [Tsai and Wu 1971]. In addition, special measures are taken for failure under compression. See [Matzenmiller and Schweizerhof 1991].

By using the user defined integration rule, see *INTEGRATION_SHELL, the constitutive constants can vary through the shell thickness. For all shells, except the DKT formulation, laminated shell theory can be activated to properly model the transverse shear deformation. Lamination theory is applied to correct for the assumption of a uniform constant shear strain through the thickness of the shell.

For sandwich shells where the outer layers are much stiffer than the inner layers, the response will tend to be too stiff unless lamination theory is used. To turn on lamination theory, see *CONTROL_SHELL. A damage model for transverse shear strain to model interlaminar shear failure is available. The definition of minimum stress limits is available for thin/thick shells and solids.

Card Summary:

Card 1. This card is required.

MID	RO	EA	EB	EC	PRBA	PRCA	PRCB
-----	----	----	----	----	------	------	------

Card 2. This card is required.

GAB	GBC	GCA	(KF)	AOPT	2WAY	TI	
-----	-----	-----	------	------	------	----	--

Card 3. This card is required.

XP	YP	ZP	A1	A2	A3	MANGLE	
----	----	----	----	----	----	--------	--

Card 4a. This card is included if the material is *MAT_054 and DFAILT ≠ 0.0.

V1	V2	V3	D1	D2	D3	DFAILM	DFAILS
----	----	----	----	----	----	--------	--------

Card 4b. This card is included if Card 4a is not included, meaning, the material is *MAT_055, or the material is *MAT_054 with DFAILT = 0.0.

V1	V2	V3	D1	D2	D3		
----	----	----	----	----	----	--	--

Card 5a. This card is included if the material is *MAT_054.

TFAIL	ALPH	SOFT	FBRT	YCFAC	DFAILT	DFAILC	EPS
-------	------	------	------	-------	--------	--------	-----

Card 5b. This card is included if the material is *MAT_055.

TFAIL	ALPH	SOFT	FBRT				
-------	------	------	------	--	--	--	--

Card 6a. This card is included if the 2WAY flag is 0.

XC	XT	YC	YT	SC	CRIT	BETA	
----	----	----	----	----	------	------	--

Card 6b. This card is included if the 2WAY flag is 1.

XC	XT	YC	YT	SC	CRIT	BETA	
----	----	----	----	----	------	------	--

Card 7. This card is only included for *MAT_054 (CRIT = 54).

PFL	EPSF	EPSR	TSMD	SOFT2			
-----	------	------	------	-------	--	--	--

Card 8a. This card is only included for *MAT_054 (CRIT = 54) and 2WAY = 0.

SLIMT1	SLIMC1	SLIMT2	SLIMC2	SLIMS	NCYRED	SOFTG	
--------	--------	--------	--------	-------	--------	-------	--

Card 8b. This card is only included for *MAT_054 (CRIT = 54) and 2WAY = 1.

SLIMT1	SLIMC1	SLIMT2	SLIMC2	SLIMS	NCYRED	SOFTG	
--------	--------	--------	--------	-------	--------	-------	--

Card 9. This card is only included for *MAT_054 (CRIT = 54).

LCXC	LCXT	LCYC	LCYT	LCSC	DT		
------	------	------	------	------	----	--	--

Data Card Definitions:

Card 1	1	2	3	4	5	6	7	8
Variable	MID	RO	EA	EB	EC	PRBA	PRCA	PRCB
Type	A	F	F	F	F	F	F	F
Remarks						6	6	6

VARIABLE	DESCRIPTION
MID	Material identification. A unique number or label must be specified (see *PART).
RO	Mass density
EA	E_a , Young's modulus - longitudinal direction
EB	E_b , Young's modulus - transverse direction
EC	E_c , Young's modulus - normal direction
PRBA	ν_{ba} , Poisson's ratio ba
PRCA	ν_{ca} , Poisson's ratio ca
PRCB	ν_{cb} , Poisson's ratio cb

Card 2	1	2	3	4	5	6	7	8
Variable	GAB	GBC	GCA	(KF)	AOPT	2WAY	TI	
Type	F	F	F	F	F	F	F	

VARIABLE	DESCRIPTION
GAB	G_{ab} , shear modulus ab
GBC	G_{bc} , shear modulus bc
GCA	G_{ca} , shear modulus ca
(KF)	Bulk modulus of failed material (not used)
AOPT	Material axes option (see MAT_OPTIONTROPIC_ELASTIC for a more complete description): <p style="margin-left: 40px;">EQ.0.0: Locally orthotropic with material axes determined by element nodes 1, 2, and 4, as with *DEFINE_COORDINATE_NODES, and then, for shells only, rotated about the shell element normal by an angle MANGLE.</p>

VARIABLE	DESCRIPTION
	<p>EQ.1.0: Locally orthotropic with material axes determined by a point in space and the global location of the element center; this is the a-direction. This option is for solid elements only.</p> <p>EQ.2.0: Globally orthotropic with material axes determined by vectors defined below, as with *DEFINE_COORDINATE_VECTOR.</p> <p>EQ.3.0: Locally orthotropic material axes determined by rotating the material axes about the element normal by an angle (MANGLE) from a line in the plane of the element defined by the cross product of the vector, \mathbf{v}, with the element normal.</p> <p>EQ.4.0: Locally orthotropic in cylindrical coordinate system with the material axes determined by a vector \mathbf{v}, and an originating point, p, which define the centerline axis. This option is for solid elements only.</p> <p>LT.0.0: The absolute value of AOPT is a coordinate system ID number (CID on *DEFINE_COORDINATE_NODES, *DEFINE_COORDINATE_SYSTEM or *DEFINE_COORDINATE_VECTOR).</p>
2WAY	<p>Flag to turn on 2-way fiber action:</p> <p>EQ.0.0: Standard unidirectional behavior, meaning fibers run only in the a-direction</p> <p>EQ.1.0: 2-way fiber behavior, meaning fibers run in both the a- and b-directions. The meaning of the fields DFAILT, DFAILC, YC, YT, SLIMIT2 and SLIMC2 are altered if this flag is set. This option is only available for *MAT_054 using thin shells.</p>
TI	<p>Flag to turn on transversal isotropic behavior for *MAT_054 solid elements.</p> <p>EQ.0.0: Standard unidirectional behavior</p> <p>EQ.1.0: Transversal isotropic behavior (see Remark 5)</p>

Card 3	1	2	3	4	5	6	7	8
Variable	XP	YP	ZP	A1	A2	A3	MANGLE	
Type	F	F	F	F	F	F	F	

VARIABLE**DESCRIPTION**

XP, YP, ZP

Coordinates of point p for AOPT = 1 and 4

A1, A2, A3

Components of vector \mathbf{a} for AOPT = 2

MANGLE

Material angle in degrees for AOPT = 0 (shells only) and AOPT = 3. MANGLE may be overridden on the element card; see *ELEMENT_SHELL_BETA and *ELEMENT_SOLID_ORTHO.

This card is included if the material is *MAT_054 and DFAILT (see Card 5a) is nonzero.

Card 4a	1	2	3	4	5	6	7	8
Variable	V1	V2	V3	D1	D2	D3	DFAILM	DFAILS
Type	F	F	F	F	F	F	F	F

VARIABLE**DESCRIPTION**

V1, V2, V3

Define components of vector \mathbf{v} for AOPT = 3.

D1, D2, D3

Define components of vector \mathbf{d} for AOPT = 2.

DFAILM

Maximum strain for matrix straining in tension or compression (active only for *MAT_054 and only if DFAILT > 0). The layer in the element is completely removed after the maximum strain in the matrix direction is reached. The input value is always positive.

DFAILS

Maximum tensorial shear strain (active only for *MAT_054 and only if DFAILT > 0). The layer in the element is completely removed after the maximum shear strain is reached. The input value is always positive.

This card is included if Card 4a is not included.

Card 4b	1	2	3	4	5	6	7	8
Variable	V1	V2	V3	D1	D2	D3		
Type	F	F	F	F	F	F		

VARIABLE**DESCRIPTION**

V1, V2, V3 Define components of vector **v** for AOPT = 3.
 D1, D2, D3 Define components of vector **d** for AOPT = 2.

This card is included if the material is *MAT_054.

Card 5a	1	2	3	4	5	6	7	8
Variable	TFAIL	ALPH	SOFT	FBRT	YCFAC	DFAILT	DFAILC	EFS
Type	F	F	F	F	F	F	F	F

VARIABLE**DESCRIPTION**

TFAIL Time step size criteria for element deletion:
 LE.0.0: No element deletion by time step size. The crashfront algorithm only works if TFAIL is set to a value greater than zero.
 GT.0.0.and.LE.0.1: Element is deleted when its time step is smaller than the given value.
 GT.0.1: Element is deleted when the quotient of the actual time step and the original time step drops below the given value.

ALPH Shear stress parameter for the nonlinear term; see *MAT_022.

SOFT Softening reduction factor for material strength in crashfront elements (default = 1.0). TFAIL must be greater than zero to activate this option. Crashfront elements are elements that are direct neighbors of failed (deleted) elements. See [Remark 2](#).

VARIABLE	DESCRIPTION
----------	-------------

FBRT	<p>Softening for fiber tensile strength:</p> <p>EQ.0.0: Tensile strength = X_T</p> <p>GT.0.0: Tensile strength = X_T, reduced to $X_T \times \text{FBRT}$ after failure has occurred in compressive matrix mode</p>
YCFAC	<p>Reduction factor for compressive fiber strength after matrix compressive failure. The compressive strength in the fiber direction after compressive matrix failure is reduced to:</p> $X_c = \text{YCFAC} \times Y_c, \quad (\text{default: YCFAC} = 2.0)$
DFAILT	<p>Maximum strain for fiber tension (*MAT_054 only). A value of 1 is 100% tensile strain. The layer in the element is completely removed after the maximum tensile strain in the fiber direction is reached. If a nonzero value is given for DFAILT (recommended), a nonzero, negative value must also be provided for DFAILC.</p> <p>If the 2-way fiber flag is set, then DFAILT is the fiber tensile failure strain in the <i>a</i> and <i>b</i> directions.</p>
DFAILC	<p>Maximum strain for fiber compression. A value of -1 is 100% compression strain. The layer in the element is completely removed after the maximum compressive strain in the fiber direction is reached. The input value should be negative and is required if DFAILT > 0.</p> <p>If the 2-way fiber flag is set, then DFAILC is the fiber compressive failure strain in the <i>a</i> and <i>b</i> directions.</p>
EFS	Effective failure strain

This card is included if the material is *MAT_055.

Card 5b	1	2	3	4	5	6	7	8
Variable	TFAIL	ALPH	SOFT	FBRT				
Type	F	F	F	F				

VARIABLE	DESCRIPTION
TFAIL	Time step size criteria for element deletion: LE.0.0: No element deletion by time step size. The crashfront algorithm only works if TFALL is set to a value greater than zero. GT.0.0.and.LE.0.1: Element is deleted when its time step is smaller than the given value. GT.0.1: Element is deleted when the quotient of the actual time step and the original time step drops below the given value.
ALPH	Shear stress parameter for the nonlinear term; see *MAT_022.
SOFT	Softening reduction factor for material strength in crashfront elements (default = 1.0). TFALL must be greater than zero to activate this option. Crashfront elements are elements that are direct neighbors of failed (deleted) elements.
FBRT	Softening for fiber tensile strength: EQ.0.0: Tensile strength = XT GT.0.0: Tensile strength = XT, reduced to XT × FBRT after failure has occurred in compressive matrix mode

This card is included if 2WAY = 0.

Card 6a	1	2	3	4	5	6	7	8
Variable	XC	XT	YC	YT	SC	CRIT	BETA	
Type	F	F	F	F	F	F	F	

VARIABLE	DESCRIPTION
XC	Longitudinal compressive strength (absolute value is used): GE.0.0: Poisson effect (PRBA) after failure is active. LT.0.0: Poisson effect after failure is not active, meaning PRBA = 0.
XT	Longitudinal tensile strength; see Material Formulation below.

VARIABLE	DESCRIPTION
YC	Transverse compressive strength, <i>b</i> -axis (positive value). See Material Formulation below.
YT	Transverse tensile strength, <i>b</i> -axis. See Material Formulation below.
SC	Shear strength, <i>ab</i> -plane. See the Material Formulation below.
CRIT	Failure criterion (material number): EQ.54.0: Chang-Chang criterion for matrix failure (as *MAT_022) (default), EQ.55.0: Tsai-Wu criterion for matrix failure.
BETA	Weighting factor for shear term in tensile fiber mode. $0.0 \leq \text{BETA} \leq 1.0$.

This card is included if 2WAY = 1 (CRIT must be 54 in this case).

Card 6b	1	2	3	4	5	6	7	8
Variable	XC	XT	YC	YT	SC	CRIT	BETA	
Type	F	F	F	F	F	F	F	

VARIABLE	DESCRIPTION
XC	Longitudinal compressive strength (absolute value is used): GE.0.0: Poisson effect (PRBA) after failure is active. LT.0.0: Poisson effect after failure is not active, meaning PRBA = 0.
XT	Longitudinal tensile strength; see Material Formulation below.
YC	Fiber compressive failure stress in the <i>b</i> -direction. See Material Formulation below.
YT	Fiber tensile failure stress in the <i>b</i> -direction. See Material Formulation below.
SC	Shear strength, <i>ab</i> -plane. See the Material Formulation below.

VARIABLE	DESCRIPTION
CRIT	Failure criterion (material number): EQ.54.0: Chang-Change criterion for matrix failure (as *MAT_022) (default), EQ.55.0: Tsai-Wu criterion for matrix failure.
BETA	Weighting factor for shear term in tensile fiber mode. $0.0 \leq \text{BETA} \leq 1.0$.

Optional Card 7 (only for CRIT = 54). This card is included for *MAT_054 only.

Card 7	1	2	3	4	5	6	7	8
Variable	PFL	EPSF	EPSR	TSMD	SOFT2			
Type	F	F	F	F	F			

VARIABLE	DESCRIPTION
PFL	Percentage of layers which must fail before crashfront is initiated (thin and thick shells only). For example, if $ \text{PFL} = 80.0$, then 80% of the layers must fail before strengths are reduced in neighboring elements. Default: all layers must fail. The sign of PFL determines how many in-plane integration points must fail for a single layer to fail: GT.0.0: A single layer fails if 1 in-plane IP fail. LT.0.0: A single layer fails if 4 in-plane IPs fail.
EPSF	Damage initiation transverse shear strain
EPSR	Final rupture transverse shear strain LT.0.0: $ \text{EPSR} $ is final rupture transverse shear strain. In addition, the element erodes if transverse shear damage reaches TSMD.
TSMD	Transverse shear maximum damage (default = 0.90)
SOFT2	Optional "orthogonal" softening reduction factor for material strength in crashfront elements (default = 1.0). See Remark 2 (thin and thick shells only).

Optional Card 8 (only for CRIT = 54). This card is included for *MAT_054 only and 2WAY = 0.

Card 8a	1	2	3	4	5	6	7	8
Variable	SLIMIT1	SLIMC1	SLIMIT2	SLIMC2	SLIMS	NCYRED	SOFTG	
Type	F	F	F	F	F	F	F	

VARIABLE**DESCRIPTION**

SLIMIT1	Factor to determine the minimum stress limit after stress maximum (fiber tension). Similar to *MAT_058.
SLIMC1	Factor to determine the minimum stress limit after stress maximum (fiber compression). Similar to *MAT_058.
SLIMIT2	Factor to determine the minimum stress limit after stress maximum (matrix tension). Similar to *MAT_058.
SLIMC2	Factor to determine the minimum stress limit after stress maximum (matrix compression). Similar to *MAT_058.
SLIMS	Factor to determine the minimum stress limit after stress maximum (shear). Similar to *MAT_058.
NCYRED	Number of cycles for stress reduction from maximum to minimum for DFAILT > 0.
SOFTG	Softening reduction factor for transverse shear moduli GBC and GCA in crashfront elements (thin and thick shells). Default = 1.0.

Optional Card 8 (only for CRIT = 54). This card is included for *MAT_054 only and 2WAY = 1.

Card 8b	1	2	3	4	5	6	7	8
Variable	SLIMIT1	SLIMC1	SLIMIT2	SLIMC2	SLIMS	NCYRED	SOFTG	
Type	F	F	F	F	F	F	F	

VARIABLE	DESCRIPTION
SLIMT1	Factor to determine the minimum stress limit after stress maximum (fiber tension) in the <i>a</i> -direction. Similar to *MAT_058.
SLIMC1	Factor to determine the minimum stress limit after stress maximum (fiber compression) in the <i>a</i> -direction. Similar to *MAT_058.
SLIMT2	Factor to determine the minimum stress limit after tensile failure stress is reached in the <i>b</i> fiber direction
SLIMC2	Factor to determine the minimum stress limit after compressive failure stress is reached in the <i>b</i> fiber direction
SLIMS	Factor to determine the minimum stress limit after stress maximum (shear). Similar to *MAT_058.
NCYRED	Number of cycles for stress reduction from maximum to minimum for DFAILT > 0.
SOFTG	Softening reduction factor for transverse shear moduli GBC and GCA in crashfront elements (thin and thick shells). Default = 1.0.

Optional Card 9 (only for CRIT = 54). This card is included for *MAT_054 only.

Card 9	1	2	3	4	5	6	7	8
Variable	LCXC	LCXT	LCYC	LCYT	LCSC	DT		
Type	I	I	I	I	I	F		

VARIABLE	DESCRIPTION
LCXC	Load curve ID for XC as a function of strain rate (XC is ignored with this option)
LCXT	Load curve ID for XT as a function strain rate (XT is ignored with this option)
LCYC	Load curve ID for YC as a function of strain rate (YC is ignored with this option)
LCYT	Load curve ID for YT as a function of strain rate (YT is ignored with this option)

VARIABLE	DESCRIPTION
LCSC	Load curve ID for SC as a function of strain rate (SC is ignored with this option)
DT	Strain rate averaging option: EQ.0.0: Strain rate is evaluated using a running average. LT.0.0: Strain rate is evaluated using an average of the last 11 time steps. GT.0.0: Strain rate is averaged over the last DT time units.

Material Formulation:

*MAT_054 Failure Criteria

The Chang-Chang (*MAT_054) criteria is given as follows:

1. For the tensile fiber mode,

$$\sigma_{aa} > 0 \Rightarrow e_f^2 = \left(\frac{\sigma_{aa}}{X_t}\right)^2 + \beta \left(\frac{\sigma_{ab}}{S_c}\right)^2 - 1, \quad \begin{array}{l} e_f^2 \geq 0 \Rightarrow \text{failed} \\ e_f^2 < 0 \Rightarrow \text{elastic} \end{array}$$

$$E_a = E_b = G_{ab} = \nu_{ba} = \nu_{ab} = 0$$

2. For the compressive fiber mode,

$$\sigma_{aa} < 0 \Rightarrow e_c^2 = \left(\frac{\sigma_{aa}}{X_c}\right)^2 - 1, \quad \begin{array}{l} e_c^2 \geq 0 \Rightarrow \text{failed} \\ e_c^2 < 0 \Rightarrow \text{elastic} \end{array}$$

$$E_a = \nu_{ba} = \nu_{ab} = 0$$

3. For the tensile matrix mode,

$$\sigma_{bb} > 0 \Rightarrow e_m^2 = \left(\frac{\sigma_{bb}}{Y_t}\right)^2 + \left(\frac{\sigma_{ab}}{S_c}\right)^2 - 1, \quad \begin{array}{l} e_m^2 \geq 0 \Rightarrow \text{failed} \\ e_m^2 < 0 \Rightarrow \text{elastic} \end{array}$$

$$E_b = \nu_{ba} = 0 \Rightarrow G_{ab} = 0$$

4. For the compressive matrix mode,

$$\sigma_{bb} < 0 \Rightarrow e_d^2 = \left(\frac{\sigma_{bb}}{2S_c}\right)^2 + \left[\left(\frac{Y_c}{2S_c}\right)^2 - 1\right] \frac{\sigma_{bb}}{Y_c} + \left(\frac{\sigma_{ab}}{S_c}\right)^2 - 1, \quad \begin{array}{l} e_d^2 \geq 0 \Rightarrow \text{failed} \\ e_d^2 < 0 \Rightarrow \text{elastic} \end{array}$$

$$E_b = \nu_{ba} = \nu_{ab} = 0 \Rightarrow G_{ab} = 0$$

$$X_c = 2Y_c, \text{ for 50\% fiber volume}$$

For $\beta = 1$ we get the original criterion of Hashin [1980] in the tensile fiber mode. For $\beta = 0$ we get the maximum stress criterion which is found to compare better to experiments.

***MAT_054 with 2-Way Fiber Flag Failure Criteria**

If the 2-way fiber flag is set, then the failure criteria for tensile and compressive fiber failure in the local x -direction are unchanged. For the local y -direction, the same failure criteria as for the x -direction fibers are used.

1. For the tensile fiber mode in the local y -direction,

$$\sigma_{bb} > 0 \Rightarrow e_f^2 = \left(\frac{\sigma_{bb}}{Y_t}\right)^2 + \beta \left(\frac{\sigma_{ab}}{S_c}\right) - 1, \quad \begin{array}{l} e_f^2 \geq 0 \Rightarrow \text{failed} \\ e_f^2 < 0 \Rightarrow \text{elastic} \end{array}$$

2. For the compressive fiber mode in the local y -direction,

$$\sigma_{bb} < 0 \Rightarrow e_c^2 = \left(\frac{\sigma_{bb}}{Y_c}\right)^2 - 1, \quad \begin{array}{l} e_c^2 \geq 0 \Rightarrow \text{failed} \\ e_c^2 < 0 \Rightarrow \text{elastic} \end{array}$$

3. For 2WAY the matrix only fails in shear,

$$e_m^2 = \left(\frac{\sigma_{ab}}{S_c}\right)^2 - 1, \quad \begin{array}{l} e_m^2 \geq 0 \Rightarrow \text{failed} \\ e_m^2 < 0 \Rightarrow \text{elastic} \end{array}$$

***MAT_055 Failure Criteria**

For the Tsai-Wu (*MAT_055) criteria, the tensile and compressive fiber modes are treated the same as in the Chang-Chang criteria. The failure criterion for the tensile and compressive matrix mode is given as:

$$e_{m/d}^2 = \frac{\sigma_{bb}^2}{Y_c Y_t} + \left(\frac{\sigma_{ab}}{S_c}\right)^2 + \frac{(Y_c - Y_t) \sigma_{bb}}{Y_c Y_t} - 1, \quad \begin{array}{l} e_{m/d}^2 \geq 0 \Rightarrow \text{failed} \\ e_{m/d}^2 < 0 \Rightarrow \text{elastic} \end{array}$$

Remarks:

1. **Integration Point Failure.** In *MAT_054, failure can occur in any of four different ways:
 - If DFAILT is zero, failure occurs if the Chang-Chang failure criterion is satisfied in the tensile fiber mode.
 - If DFAILT is greater than zero, failure occurs if:
 - the fiber strain is greater than DFAILT or less than DFAILC
 - if absolute value of matrix strain is greater than DFAILM

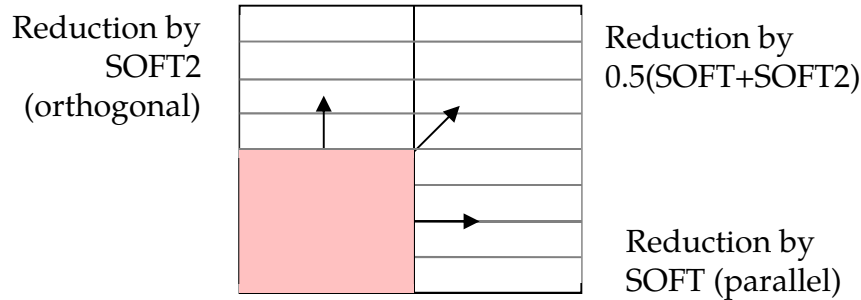

Figure M54-1. Direction dependent softening

- if absolute value of tensorial shear strain is greater than DFAILS
- If EFS is greater than zero, failure occurs if the effective strain is greater than EFS.
- If TFAIL is greater than zero, failure occurs according to the element timestep as described in the definition of TFAIL above.

In *MAT_055, an integration point is deleted (all stresses go to zero) only if the tensile stress at that point reaches XT. Other strengths, XC, YT, YC, SC serve to cap stresses but do not delete the integration point.

When failure has occurred in all the composite layers (through-thickness integration points), the element is deleted. For bricks, the element is deleted after one integration point has met the failure criteria.

2. **Crashfront Elements and Strength Reduction.** Elements which share nodes with a deleted element become “crashfront” elements and can have their strengths reduced by using the SOFT parameter with TFAIL greater than zero. An earlier initiation of crashfront elements is possible by using parameter PFL.

An optional direction dependent strength reduction can be invoked by setting $0 < \text{SOFT2} < 1$. Then, SOFT equals a strength reduction factor for fiber parallel failure and SOFT2 equals a strength reduction factor for fiber orthogonal failure. Linear interpolation is used for angles in between. See [Figure M54-1](#).

3. **Transverse Shear Strain Damage Model.** In an optional damage model for transverse shear strain, out-of-plane stiffness (GBC and GCA) can linearly decrease to model interlaminar shear failure. Damage starts when effective transverse shear strain

$$\varepsilon_{56}^{\text{eff}} = \sqrt{\varepsilon_{yz}^2 + \varepsilon_{zx}^2}$$

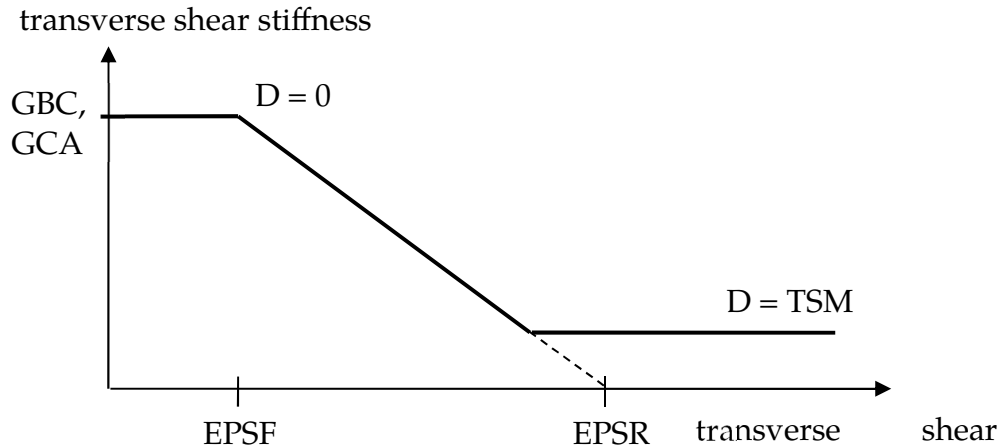

Figure M54-2. Linear Damage for transverse shear behavior

reaches EPSF. Final rupture occurs when effective transverse shear strain reaches EPSR. A maximum damage of TSMD ($0.0 < TSMD < 0.99$) cannot be exceeded. See [Figure M54-2](#).

- Failure/Damage Status.** The status in each layer (integration point) and element can be plotted using additional integration point history variables. The number of additional integration point history variables for shells written to the LS-DYNA database is input by the *DATABASE_EXTENT_BINARY definition as variable NEIPS. For Models 54 and 55 these additional history variables are tabulated below (i = shell integration point):

History Variable	Description	Value
1 ef(<i>i</i>)	tensile fiber mode	1 - elastic
2 ec(<i>i</i>)	compressive fiber mode	
3 em(<i>i</i>)	tensile (shear for 2WAY) matrix mode	
4 ed(<i>i</i>)	compressive matrix mode	0 - failed
5 efail	max[ef(ip)]	
6 dam	damage parameter	-1 - element intact 10 ⁻⁸ - element in crashfront 1 - element failed

The variables in the table above are labeled by LS-PrePost simply as history variables 1 to 6.

The three element history variables in the table below, which represent the fraction of elastic (non-failed) integration points in tensile fiber, compressive fiber,

and tensile matrix modes, resp., are labeled as “effective plastic strain” by LS-PrePost for integration points 1, 2, and 3.

Description	Integration point
$\frac{1}{n_{ip}} \sum_{i=1}^{n_{ip}} ef(i)$	1
$\frac{1}{n_{ip}} \sum_{i=1}^{n_{ip}} ec(i)$	2
$\frac{1}{n_{ip}} \sum_{i=1}^{n_{ip}} em(i)$	3

- TI-Flag.** This applies only to transversal isotropic behavior for *MAT_054 solid elements. The behavior in the *bc*-plane is assumed to be isotropic, thus the elastic constants EC, PRCA and GCA are ignored and set according to the given values EA, EB, PRAB, and GAB. Damage in transverse shear (EPSF, EPSR, TSMD, SOFTG) is ignored. The failure criterion is evaluated by replacing σ_{bb} and σ_{ab} with the corresponding stresses σ_{11} and σ_{a1} in a principal stress frame rotated around the local a-axis. The principal axes 1 and 2 in the b-c plane are chosen such that $|\sigma_{11}| \geq |\sigma_{22}|$ is fulfilled.
- Material Parameters.** PRBA is the minor Poisson's ratio if EA>EB, and the major Poisson's ratio will be equal to PRBA*(EA/EB). If EB > EA, then PRBA is the major Poisson's ratio. PRCA and PRCB are similarly defined. They are the minor Poisson's ratio if EA>EC or EB>EC, and the major Poisson's ratio if the EC>EA or EC>EB.

Care should be taken when using material parameters from third party products regarding the directional indices *a*, *b* and *c*, as they may differ from the definition used in LS-DYNA. For the direction indices used in LS-DYNA see section 'Remarks' in MAT_002 / MAT_OPTIONTROPIC_ELASTIC.

***MAT_LOW_DENSITY_FOAM**

This is Material Type 57 for modeling highly compressible low density foams. Its main applications are for seat cushions and padding on the Side Impact Dummies (SID). Optionally, a tension cut-off failure can be defined. A table can be defined if thermal effects are considered in the nominal stress as a function of strain behavior. Also, see the remarks below.

Card 1	1	2	3	4	5	6	7	8
Variable	MID	RO	E	LCID	TC	HU	BETA	DAMP
Type	A	F	F	F	F	F	F	F
Default	none	none	none	none	10 ²⁰	1.	none	0.05
Remarks						3	1	

Card 2	1	2	3	4	5	6	7	8
Variable	SHAPE	FAIL	BVFLAG	ED	BETA1	KCON	REF	
Type	F	F	F	F	F	F	F	
Default	1.0	0.0	0.0	0.0	0.0	0.0	0.0	
Remarks	3		2	5	5	6		

VARIABLE**DESCRIPTION**

MID	Material identification. A unique number or label must be specified (see *PART).
RO	Mass density
E	Young's modulus used in tension. For implicit problems E is set to the initial slope of load curve LCID.

VARIABLE	DESCRIPTION
LCID	Load curve ID (see *DEFINE_CURVE) or table ID defining the nominal stress as a function of nominal strain. If a table is used, a family of curves is defined each corresponding to a discrete temperature; see *DEFINE_TABLE.
TC	Cut-off for the nominal tensile stress, τ_i .
HU	Hysteretic unloading factor between 0.0 and 1.0 (default = 1.0, that is, no energy dissipation); see also Figure M57-1 .
BETA	Decay constant to model creep in unloading, β .
DAMP	Viscous coefficient ($.05 < \text{recommended value} < .50$) to model damping effects. <p>LT.0.0: DAMP is the load curve ID, which defines the damping constant as a function of the maximum strain in compression defined as:</p> $\varepsilon_{\max} = \max(1 - \lambda_1, 1 - \lambda_2, 1 - \lambda_3) .$ <p>In tension, the damping constant is set to the value corresponding to the strain at 0.0. The abscissa should be defined from 0.0 to 1.0.</p>
SHAPE	Shape factor for unloading. Active for nonzero values of the hysteretic unloading factor. Values less than one reduces the energy dissipation and greater than one increases dissipation; see also Figure M57-1 .
FAIL	Failure option after cutoff stress is reached: <p>EQ.0.0: tensile stress remains at cut-off value. EQ.1.0: tensile stress is reset to zero.</p>
BVFLAG	Bulk viscosity activation flag: <p>EQ.0.0: no bulk viscosity (recommended) EQ.1.0: bulk viscosity active</p>
ED	Optional Young's relaxation modulus, E_d , for rate effects.
BETA1	Optional decay constant, β_1 .

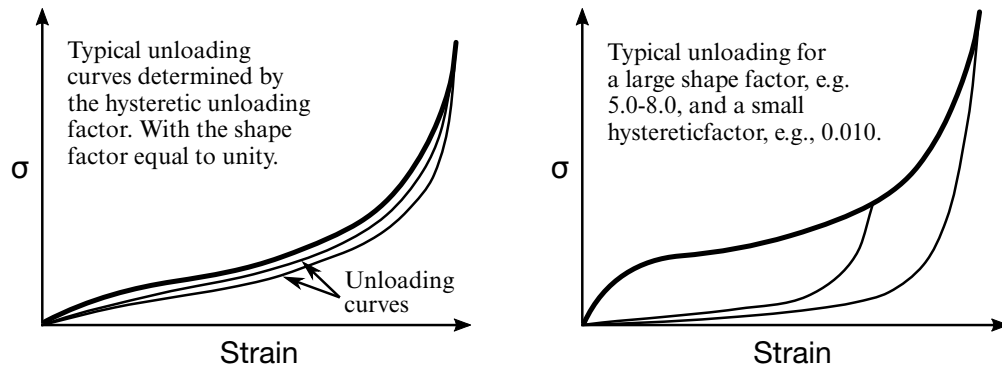

Figure M57-1. Behavior of the low density urethane foam model

VARIABLE	DESCRIPTION
KCON	Stiffness coefficient for contact interface stiffness. If undefined the maximum slope in the stress as a function of strain curve is used. When the maximum slope is taken for the contact, the time step size for this material is reduced for stability. In some cases, Δt may be significantly smaller, so defining a reasonable stiffness is recommended.
REF	Use reference geometry to initialize the stress tensor. The reference geometry is defined by the keyword: *INITIAL_FOAM_REFERENCE_GEOMETRY. EQ.0.0: off EQ.1.0: on

Material Formulation:

The compressive behavior is illustrated in Figure M57-1 where hysteresis upon unloading is shown. This behavior under uniaxial loading is assumed not to significantly couple in the transverse directions. In tension the material behaves in a linear fashion until tearing occurs. Although our implementation may be somewhat unusual, it was motivated by Storakers [1986].

The model uses tabulated input data for the loading curve where the nominal stresses are defined as a function of the elongations, ϵ_i , which are defined in terms of the principal stretches, λ_i , as:

$$\epsilon_i = \lambda_i - 1$$

The negative of the principal elongations (negative of principal engineering strains) are stored in an arbitrary order as extra history variables 16, 17, and 18 if ED = 0 and as extra history variables 28, 29, and 30 if ED > 0. (See NEIPH in *DATABASE_EXTENT_BINARY for output of extra history variables.) The stretch ratios are found by solving for the

eigenvalues of the left stretch tensor, V_{ij} , which is obtained using a polar decomposition of the deformation gradient matrix, F_{ij} . Recall that,

$$F_{ij} = R_{ik}U_{kj} = V_{ik}R_{kj}$$

The update of V_{ij} follows the numerically stable approach of Taylor and Flanagan [1989]. After solving for the principal stretches, we compute the elongations and, if the elongations are compressive, the corresponding values of the nominal stresses, τ_i are interpolated. If the elongations are tensile, the nominal stresses are given by

$$\tau_i = E\varepsilon_i$$

and the Cauchy stresses in the principal system become

$$\sigma_i = \frac{\tau_i}{\lambda_j \lambda_k} .$$

The stresses can now be transformed back into the global system for the nodal force calculations.

Remarks:

1. **Decay Constant and Hysteretic Unloading.** When hysteretic unloading is used the reloading will follow the unloading curve if the decay constant, β , is set to zero. If β is nonzero the decay to the original loading curve is governed by the expression:

$$1 - e^{-\beta t} .$$

2. **Bulk Viscosity.** The bulk viscosity, which generates a rate dependent pressure, may cause an unexpected volumetric response and, consequently, it is optional with this model.
3. **Hysteretic Unloading Factor.** The hysteretic unloading factor results in the unloading curve to lie beneath the loading curve as shown in [Figure M57-1](#) This unloading provides energy dissipation which is reasonable in certain kinds of foam.
4. **Output.** Note that since this material has no effective plastic strain, the internal energy per initial volume is written into the output databases.
5. **Rate Effects.** Rate effects are accounted for through linear viscoelasticity by a convolution integral of the form

$$\sigma_{ij}^r = \int_0^t g_{ijkl}(t - \tau) \frac{\partial \varepsilon_{kl}}{\partial \tau} d\tau ,$$

where $g_{ijkl}(t - \tau)$ is the relaxation function. The stress tensor, σ_{ij}^r , augments the stresses determined from the foam, σ_{ij}^f ; consequently, the final stress, σ_{ij} , is taken as the summation of the two contributions:

$$\sigma_{ij} = \sigma_{ij}^f + \sigma_{ij}^r .$$

Since we wish to include only simple rate effects, the relaxation function is represented by one term from the Prony series:

$$g(t) = \alpha_0 + \sum_{m=1}^N \alpha_m e^{-\beta_m t}$$

given by,

$$g(t) = E_d e^{-\beta_1 t} .$$

This model is effectively a Maxwell fluid which consists of a damper and spring in series. We characterize this in the input by a Young's modulus, E_d , and decay constant, β_1 . The formulation is performed in the local system of principal stretches where only the principal values of stress are computed and triaxial coupling is avoided. Consequently, the one-dimensional nature of this foam material is unaffected by this addition of rate effects. The addition of rate effects necessitates twelve additional history variables per integration point. The cost and memory overhead of this model comes primarily from the need to "remember" the local system of principal stretches.

6. **Time Step Size.** The time step size is based on the current density and the maximum of the instantaneous loading slope, E , and KCON. If KCON is undefined, the maximum slope in the loading curve is used instead.

*MAT_LAMINATED_COMPOSITE_FABRIC_{OPTION}

Available options include:

SOLID

Without the keyword option, this model supports shell elements and thick shell elements with ELFORM = 1, 2, or 6. The SOLID option allows the model to work for solid elements.

This is Material Type 58. Depending on the type of failure surface, this material can model composite materials with unidirectional layers, complete laminates, and woven fabrics. We implemented this model for shell, thick shell, and solid elements. Shell elements and thick shell elements with ELFORM = 1, 2, or 6 require no keyword option, while solid elements require the SOLID keyword option.

Card Summary:

Card 1. This card is required.

MID	RO	EA	EB	EC	PRBA	TAU1	GAMMA1
-----	----	----	----	----	------	------	--------

Card 2. This card is required.

GAB	GBC	GCA	SLIMT1	SLIMC1	SLIMT2	SLIMC2	SLIMS
-----	-----	-----	--------	--------	--------	--------	-------

Card 3. This card is required.

AOPT	TSIZE	ERODS	SOFT	FS	EPSF	EPSR	TSMD
------	-------	-------	------	----	------	------	------

Card 4. This card is required.

XP	YP	ZP	A1	A2	A3	PRCA	PRCB
----	----	----	----	----	----	------	------

Card 5. This card is required.

V1	V2	V3	D1	D2	D3	BETA	LCDFAIL
----	----	----	----	----	----	------	---------

Card 6. This card is required.

E11C	E11T	E22C	E22T	GMS			
------	------	------	------	-----	--	--	--

Card 7. This card is required.

XC	XT	YC	YT	SC			
----	----	----	----	----	--	--	--

Card 8.1. This card is required for the SOLID keyword option.

E33C	E33T	GMS23	GMS31				
------	------	-------	-------	--	--	--	--

Card 8.2. This card is required for the SOLID keyword option.

ZC	ZT	SC23	SC31				
----	----	------	------	--	--	--	--

Card 8.3. This card is required for the SOLID keyword option.

SLIMT3	SLIMC3	SLIMS23	SLIMS31	TAU2	GAMMA2	TAU3	GAMMA3
--------	--------	---------	---------	------	--------	------	--------

Card 9. This card is optional. (shells and solids)

LCXC	LCXT	LCYC	LCYT	LCSC	LCTAU	LCGAM	DT
------	------	------	------	------	-------	-------	----

Card 10. This card is optional. (shells and solids)

LCE11C	LCE11T	LCE22C	LCE22T	LCGMS	LCEFS		
--------	--------	--------	--------	-------	-------	--	--

Card 11. This card is optional. (solids only!)

LCZC	LCZT	LCSC23	LCSC31	LCTAU2	LCGAM2	LCTAU3	LCGAM3
------	------	--------	--------	--------	--------	--------	--------

Card 12. This card is optional. (solids only!)

LCE33C	LCE33T	LCGMS23	LCGMS31				
--------	--------	---------	---------	--	--	--	--

Data Card Definitions:

Card 1	1	2	3	4	5	6	7	8
Variable	MID	RO	EA	EB	EC	PRBA	TAU1	GAMMA1
Type	A	F	F	F	F	F	F	F

VARIABLE

DESCRIPTION

MID Material identification. A unique number or label must be specified (see *PART).

RO Mass density

VARIABLE	DESCRIPTION
EA	<p>GT.0.0: E_a, Young's modulus - longitudinal direction</p> <p>LT.0.0: Load Curve ID or Table ID = (-EA). See Remark 8.</p> <p>Load Curve. When -EA is equal to a load curve ID, it is taken as defining the uniaxial elastic stress as a function of strain behavior in the longitudinal direction. Negative data points correspond to compression, and positive values to tension.</p> <p>Tabular Data. When -EA is equal to a table ID, it defines a load curve ID for each strain rate value. The load curves give the uniaxial elastic stress as a function of strain behavior in the longitudinal direction.</p> <p>Logarithmically Defined Tables. Suppose the first uniaxial elastic stress as a function of strain curve in the table corresponds to a negative strain rate. In that case, LS-DYNA assumes that the natural logarithm of the strain rate value is used for <i>all</i> stress-strain curves.</p>
EB	<p>GT.0.0: E_b, Young's modulus - transverse direction</p> <p>LT.0.0: Load Curve ID or Table ID = (-EB). See Remark 8.</p> <p>Load Curve. When -EB is equal to a load curve ID, it is taken as defining the uniaxial elastic stress as a function of strain behavior in the transverse direction. Negative data points correspond to compression, and positive values to tension.</p> <p>Tabular Data. When -EB corresponds to a table ID, it specifies a load curve ID for each strain rate value. The load curves give the uniaxial elastic stress as a function of strain behavior in the transverse direction.</p> <p>Logarithmically Defined Tables. Suppose the first uniaxial elastic stress as a function of strain curve in the table corresponds to a negative strain rate. In that case, LS-DYNA assumes that the natural logarithm of the strain rate value is used for <i>all</i> stress-strain curves.</p>
EC	<p>E_c, Young's modulus - normal direction (used only by thick shells and solids). See Remark 6.</p> <p>GT.0.0: E_c, Young's modulus - normal direction</p> <p>LT.0.0: Load Curve ID or Table ID = (-EC) (solids only). See</p>

VARIABLE	DESCRIPTION
----------	-------------

Remark 8.

Load Curve. When -EC is equal to a load curve ID, it is taken as defining the uniaxial elastic stress as a function of strain behavior in the transverse direction. Negative data points correspond to compression, and positive values to tension.

Tabular Data. When -EC corresponds to a table ID, it specifies a load curve ID for each strain rate value. The load curves give the uniaxial elastic stress as a function of strain behavior in the transverse direction.

Logarithmically Defined Tables. Suppose the first uniaxial elastic stress as a function of strain curve in the table corresponds to a negative strain rate. In that case, LS-DYNA assumes that the natural logarithm of the strain rate value is used for *all* stress-strain curves.

PRBA	ν_{ba} , Poisson's ratio ba
TAU1	τ_1 , stress limit of the first slightly nonlinear part of the shear stress as a function of shear strain curve. The values τ_1 and γ_1 help define a shear stress as a function of shear strain curve. Input these values if you set FS to -1 (see Card 3).
GAMMA1	γ_1 , strain limit of the first slightly nonlinear part of the shear stress as a function of engineering shear strain curve

Card 2	1	2	3	4	5	6	7	8
Variable	GAB	GBC	GCA	SLIMIT1	SLIMC1	SLIMIT2	SLIMC2	SLIMS
Type	F	F	F	F	F	F	F	F

VARIABLE	DESCRIPTION
----------	-------------

GAB	<p>GT.0.0: G_{ab}, shear modulus in the ab-direction</p> <p>LT.0.0: Load Curve ID or Table ID = (-GAB)</p> <p>Load Curve. When -GAB is equal to a load curve ID, it is taken as defining the elastic shear stress as a function of shear strain behavior in the ab-direction.</p>
-----	---

VARIABLE

DESCRIPTION

GBC	<p>GT.0.0: G_{bc}, shear modulus in the cb-direction</p> <p>LT.0.0: Load Curve ID or Table ID = (-GBC) (solids only)</p> <p>Load Curve. When -GBC is equal to a load curve ID, it is taken as defining the elastic shear stress as a function of shear strain behavior in the bc-direction.</p> <p>Tabular Data. When -GBC corresponds to a table ID, it defines a load curve ID for each strain rate value. The load curves give the elastic shear stress as a function of shear strain behavior in the bc-direction.</p> <p>Logarithmically Defined Tables. If the <i>first</i> elastic shear stress as a function of shear strain curve in the table corresponds to a negative strain rate, LS-DYNA assumes that the natural logarithm of the strain rate value is used for <i>all</i> shear stress-shear strain curves.</p>
GCA	<p>GT.0.0: G_{ca}, shear modulus in the ca-direction</p> <p>LT.0.0: Load Curve ID or Table ID = (-GCA) (solids only)</p> <p>Load Curve. When -GCA is equal to a load curve ID, it is taken as defining the elastic shear stress as a function of shear strain behavior in the ca-direction.</p> <p>Tabular Data. When -GCA refers to a table ID, it defines a load curve ID for each strain rate value. The load curves give the elastic shear stress as a function of shear strain behavior in the ca-direction.</p> <p>Logarithmically Defined Tables. If the <i>first</i> elastic shear stress as a function of shear strain curve in the table corresponds to a negative strain rate, LS-DYNA assumes that the natural logarithm of the strain rate value</p>

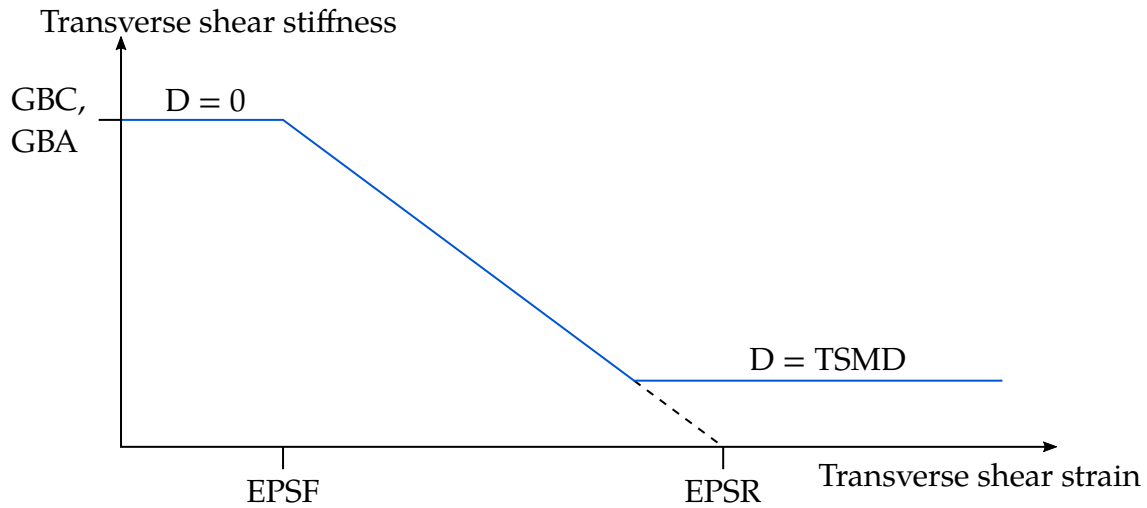

Figure M58-1. Linear Damage for Transverse Shear Behavior

VARIABLE	DESCRIPTION
	is used for <i>all</i> shear stress-shear strain curves.
SLIMT1	Factor to determine the minimum stress limit after stress maximum (fiber tension)
SLIMC1	Factor to determine the minimum stress limit after stress maximum (fiber compression)
SLIMT2	Factor to determine the minimum stress limit after stress maximum (matrix tension)
SLIMC2	Factor to determine the minimum stress limit after stress maximum (matrix compression)
SLIMS	Factor to determine the minimum stress limit after stress maximum (shear)

Card 3	1	2	3	4	5	6	7	8
Variable	AOPT	TSIZE	ERODS	SOFT	FS	EPSF	EPSR	TSMD
Type	F	F	F	F	F	F	F	F

VARIABLE	DESCRIPTION
AOPT	<p>Material axes option (see *MAT_002 for a complete description):</p> <p>EQ.0.0: Locally orthotropic with material axes determined by element nodes, as shown in Figure M2-1. For shells only, the material axes are then rotated about the normal vector to the surface of the shell by the angle BETA.</p> <p>EQ.1.0: Locally orthotropic with material axes determined by a point, P, in space and the global location of the element center; this is the \mathbf{a}-direction. This option is for solid elements only.</p> <p>EQ.2.0: Globally orthotropic with material axes determined by vectors \mathbf{a} and \mathbf{d} input below, as with *DEFINE_COORDINATE_VECTOR</p> <p>EQ.3.0: Locally orthotropic material axes determined by a vector \mathbf{v} and the normal vector to the plane of the element (see Figure M2-1). The plane of a solid element is the midsurface between the inner surface and outer surface defined by the first four nodes and the last four nodes of the connectivity of the element, respectively. Thus, for solid elements, AOPT = 3 is only available for hexahedrons. \mathbf{a} is determined by taking the cross product of \mathbf{v} with the normal vector, \mathbf{b} is determined by taking the cross product of the normal vector with \mathbf{a}, and \mathbf{c} is the normal vector. Then an angle BETA, which you set in the element's keyword input or the input for this keyword, rotates \mathbf{a} and \mathbf{b} about \mathbf{c}.</p> <p>EQ.4.0: Locally orthotropic in a cylindrical coordinate system with the material axes determined by a vector \mathbf{v}, and an originating point, P, which define the centerline axis. This option is for solid elements only.</p> <p>LT.0.0: AOPT is a coordinate system ID (see *DEFINE_COORDINATE_OPTION).</p>
TSIZE	Time step for automatic element deletion
ERODS	<p>Maximum effective strain for element layer failure. A value of unity would equal 100% strain (see Remark 1).</p> <p>GT.0.0: Fails when effective strain calculated assuming the material is volume preserving exceeds ERODS (old way)</p>

VARIABLE	DESCRIPTION
-----------------	--------------------

	LT.0.0: Fails when effective strain calculated from the full strain tensor exceeds ERODS
SOFT	Softening reduction factor for strength in the crashfront (see Remark 3)
FS	Failure surface type (see Remarks 4 and 5): EQ.1.0: Smooth failure surface with a quadratic criterion for both the fiber (<i>a</i>) and transverse (<i>b</i>) directions. This option can be used with complete laminates and fabrics. EQ.0.0: Smooth failure surface in the transverse (<i>b</i>) direction with a limiting value in the fiber (<i>a</i>) direction. This model is appropriate for unidirectional (UD) layered composites only. EQ.-1.0: Faceted failure surface. When the strength values are reached, damage evolves in tension and compression for the fiber and transverse direction. Shear behavior is also considered. This option can be used with complete laminates and fabrics.
EPSF	Damage initiation transverse shear strain
EPSR	Final rupture transverse shear strain
TSMMD	Transverse shear maximum damage; default = 0.90.

Card 4	1	2	3	4	5	6	7	8
Variable	XP	YP	ZP	A1	A2	A3	PRCA	PRCB
Type	F	F	F	F	F	F	F	F

VARIABLE	DESCRIPTION
-----------------	--------------------

XP, YP, ZP	Coordinates of point <i>p</i> for AOPT = 1 and 4
A1, A2, A3	Components of vector a for AOPT = 2
PRCA	ν_{ca} , Poisson's ratio <i>ca</i> (default = PRBA)
PRCB	ν_{cb} , Poisson's ratio <i>cb</i> (default = PRBA)

Card 5	1	2	3	4	5	6	7	8
Variable	V1	V2	V3	D1	D2	D3	BETA	LCDFAIL
Type	F	F	F	F	F	F	F	F

VARIABLE**DESCRIPTION**

V1, V2 V3

Components of vector \mathbf{v} for AOPT = 3 and 4

D1, D2, D3

Components of vector \mathbf{d} for AOPT = 2

BETA

Angle in degrees of a material rotation about the c -axis, available for AOPT = 0 (shells and tshells only) and AOPT = 3 (all element types). This angle may be overridden on the element card; see *ELEMENT_SHELL_BETA, *ELEMENT_TSHELL_BETA, and *ELEMENT_SOLID_ORTHO.

LCDFAIL

Load curve ID, which defines orientation-dependent failure strains. The ordinate values in the load curve define the various failure strains in the following order:

1. EF_11T: tensile failure strain in longitudinal a -direction
2. EF_11C: compressive failure strain in longitudinal a -direction
3. EF_22T: tensile failure strain in transverse b -direction
4. EF_22C: compressive failure strain in transverse b -direction
5. EF_12: in-plane shear failure strain in ab -plane
6. EF_33T: tensile failure strain in transverse c -direction
7. EF_33C: compressive failure strain in transverse c -direction
8. EF_23: out-of-plane shear failure strain in bc -plane
9. EF_31: out-of-plane shear failure strain in ca -plane

VARIABLE**DESCRIPTION**

Thus, the load curve to define these values must have either five (shells) or nine (solids) entries in its definition. You may input a load curve with nine entries for shells, but LS-DYNA ignores the last four entries. The ignored abscissa values need to be ascending, such as 1.0, 2.0, ..., 9.0.

Card 6	1	2	3	4	5	6	7	8
Variable	E11C	E11T	E22C	E22T	GMS			
Type	F	F	F	F	F			

VARIABLE**DESCRIPTION**

E11C Strain at longitudinal compressive strength, *a*-axis (positive)

E11T Strain at longitudinal tensile strength, *a*-axis

E22C Strain at transverse compressive strength, *b*-axis

E22T Strain at transverse tensile strength, *b*-axis

GMS Engineering shear strain at shear strength, *ab*-plane

Card 7	1	2	3	4	5	6	7	8
Variable	XC	XT	YC	YT	SC			
Type	F	F	F	F	F			

VARIABLE**DESCRIPTION**

XC Longitudinal compressive strength (positive value); see [Remark 2](#).

XT Longitudinal tensile strength; see [Remark 2](#).

YC Transverse compressive strength, *b*-axis (positive value); see [Remark 2](#).

YT Transverse tensile strength, *b*-axis; see [Remark 2](#).

VARIABLE	DESCRIPTION
SC	Shear strength, <i>ab</i> -plane; see below Remark 2 .

Card 8.1 for SOLID Keyword Option.

Card 8.1	1	2	3	4	5	6	7	8
Variable	E33C	E33T	GMS23	GMS31				
Type	F	F	F	F				

VARIABLE	DESCRIPTION
E33C	Strain at transverse compressive strength, <i>c</i> -axis.
E33T	Strain at transverse tensile strength, <i>c</i> -axis.
GMS23	Engineering shear strain at shear strength, <i>bc</i> -plane.
GMS31	Engineering shear strain at shear strength, <i>ca</i> -plane.

Card 8.2 for SOLID Keyword Option.

Card 8.2	1	2	3	4	5	6	7	8
Variable	ZC	ZT	SC23	SC31				
Type	F	F	F	F				

VARIABLE	DESCRIPTION
ZC	Transverse compressive strength, <i>c</i> -axis (positive value).
ZT	Transverse tensile strength, <i>c</i> -axis.
SC23	Shear strength, <i>bc</i> -plane.
SC31	Shear strength, <i>ca</i> -plane.

Card 8.3 for SOLID Keyword Option.

Card 8.3	1	2	3	4	5	6	7	8
Variable	SLIMT3	SLIMC3	SLIMS23	SLIMS31	TAU2	GAMMA2	TAU3	GAMMA3
Type	F	F	F	F	F	F	F	F

VARIABLE**DESCRIPTION**

SLIMT3	Factor to determine the minimum stress limit after stress maximum (matrix tension, <i>c</i> -axis).
SLIMC3	Factor to determine the minimum stress limit after stress maximum (matrix compression, <i>c</i> -axis).
SLIMS23	Factor to determine the minimum stress limit after stress maximum (shear, <i>bc</i> -plane).
SLIMS31	Factor to determine the minimum stress limit after stress maximum (shear, <i>ca</i> -plane).
TAU2	τ_2 , stress limit of the first slightly nonlinear part of the shear stress as a function of shear strain curve. The values τ_2 and γ_2 are used to define a shear stress as a function of shear strain curve. Input these values if FS = -1 (see Card 3). These values are for the <i>bc</i> -plane.
GAMMA2	γ_2 , strain limit of the first slightly nonlinear part of the shear stress as a function of engineering shear strain curve (<i>bc</i> -plane).
TAU3	τ_3 , stress limit of the first slightly nonlinear part of the shear stress as a function of shear strain curve. The values τ_3 and γ_3 help define a shear stress as a function of shear strain curve. Input these values if FS = -1 on Card 3 (<i>ca</i> -plane).
GAMMA3	γ_3 , strain limit of the first slightly nonlinear part of the shear stress as a function of engineering shear strain curve (<i>bc</i> -plane).

First Optional Strain Rate Dependence Card. (shells and solids)

Card 9	1	2	3	4	5	6	7	8
Variable	LCXC	LCXT	LCYC	LCYT	LCSC	LCTAU	LCGAM	DT
Type	I	I	I	I	I	I	I	F

VARIABLE**DESCRIPTION**

LCXC	Load curve ID defining longitudinal compressive strength XC as a function of strain rate (XC is ignored with that option). If the first strain rate value in the curve is negative, LS-DYNA assumes that you input all the strain rate values as the natural logarithm of the strain rate.
LCXT	Load curve ID defining longitudinal tensile strength XT as a function of strain rate (XT is ignored with this option). If the first strain rate value in the curve is negative, LS-DYNA assumes that you input all the strain rate values as the natural logarithm of the strain rate.
LCYC	Load curve ID defining transverse compressive strength YC as a function of strain rate (YC is ignored with this option). If the first strain rate value in the curve is negative, LS-DYNA assumes that you input all the strain rate values as the natural logarithm of the strain rate.
LCYT	Load curve ID defining transverse tensile strength YT as a function of strain rate (YT is ignored with this option). If the first strain rate value in the curve is negative, LS-DYNA assumes that you input all the strain rate values as the natural logarithm of the strain rate.
LCSC	Load curve ID defining shear strength SC as a function of strain rate (SC is ignored with this option). If the first strain rate value in the curve is negative, LS-DYNA assumes that you input all the strain rate values as the natural logarithm of the strain rate.
LCTAU	Load curve ID defining TAU1 as a function of strain rate (TAU1 is ignored with this option). This value is only used for FS = -1. If the first strain rate value in the curve is negative, LS-DYNA assumes that you input all the strain rate values as the natural logarithm of the strain rate.

VARIABLE	DESCRIPTION
LCGAM	Load curve ID defining GAMMA1 as a function of strain rate (GAMMA1 is ignored with this option). This value is only used for FS = -1. If the first strain rate value in the curve is negative, LS-DYNA assumes that you input all the strain rate values as the natural logarithm of the strain rate.
DT	Strain rate averaging option: EQ.0.0: Strain rate is evaluated using a running average. LT.0.0: Strain rate is evaluated using the average over the last 11 time steps. GT.0.0: Strain rate is averaged over the last DT time units.

Second Optional Strain Rate Dependence Card. (shells and solids)

Card 10	1	2	3	4	5	6	7	8
Variable	LCE11C	LCE11T	LCE22C	LCE22T	LCGMS	LCEFS		
Type	I	I	I	I	I	I		

VARIABLE	DESCRIPTION
LCE11C	Load curve ID defining E11C as a function of strain rate (E11C is ignored with this option). If the first strain rate value in the curve is negative, LS-DYNA assumes that you input all the strain rate values as the natural logarithm of the strain rate.
LCE11T	Load curve ID defining E11T as a function of strain rate (E11T is ignored with this option). If the first strain rate value in the curve is negative, LS-DYNA assumes that you input all the strain rate values as the natural logarithm of the strain rate.
LCE22C	Load curve ID defining E22C as a function of strain rate (E22C is ignored with this option). If the first strain rate value in the curve is negative, LS-DYNA assumes that you input all the strain rate values as the natural logarithm of the strain rate.
LCE22T	Load curve ID defining E22T as a function of strain rate (E22T is ignored with this option). If the first strain rate value in the curve is negative, LS-DYNA assumes that you input all the strain rate values as the natural logarithm of the strain rate.

VARIABLE	DESCRIPTION
LCGMS	Load curve ID defining GMS as a function of strain rate (GMS is ignored with this option). If the first strain rate value in the curve is negative, LS-DYNA assumes that you input all the strain rate values as the natural logarithm of the strain rate.
LCEFS	Load curve ID defining ERODS as a function of strain rate (ERODS is ignored with this option). LS-DYNA uses the full strain tensor to compute the equivalent strain. If the first strain rate value in the curve is negative, LS-DYNA assumes that you input all the strain rate values as the natural logarithm of the strain rate.

Third Optional Strain Rate Dependence Card. (solid only!)

Card 11	1	2	3	4	5	6	7	8
Variable	LCZC	LCZT	LCSC23	LCSC31	LCTAU2	LCGAM2	LCTAU3	LCGAM3
Type								

VARIABLE	DESCRIPTION
LCZC	Load curve ID defining transverse compressive strength ZC as a function of strain rate (ZC is ignored with that option). If the first strain rate value in the curve is negative, all the strain rate values are assumed to be given as the natural logarithm of the strain rate.
LCZT	Load curve ID defining transverse tensile strength ZT as a function of strain rate (ZT is ignored with this option). If the first strain rate value in the curve is negative, all the strain rate values are assumed to be given as the natural logarithm of the strain rate.
LCSC23	Load curve ID defining shear strength SC23 as a function of strain rate (SC23 is ignored with this option). If the first strain rate value in the curve is negative, all the strain rate values are assumed to be given as the natural logarithm of the strain rate.
LCSC31	Load curve ID defining shear strength SC31 as a function of strain rate (SC31 is ignored with this option). If the first strain rate value in the curve is negative, all the strain rate values are assumed to be given as the natural logarithm of the strain rate.
LCTAU2	Load curve ID defining TAU2 as a function of strain rate (TAU2 is ignored with this option). This value is only used for FS = -1. If the

VARIABLE	DESCRIPTION
	first strain rate value in the curve is negative, all the strain rate values are assumed to be given as the natural logarithm of the strain rate.
LCGAM2	Load curve ID defining GAMMA2 as a function of strain rate (GAMMA2 is ignored with this option). This value is only used for FS = -1. If the first strain rate value in the curve is negative, all the strain rate values are assumed to be given as the natural logarithm of the strain rate.
LCTAU3	Load curve ID defining TAU3 as a function of strain rate (TAU3 is ignored with this option). This value is only used for FS = -1. If the first strain rate value in the curve is negative, all the strain rate values are assumed to be given as the natural logarithm of the strain rate.
LCGAM3	Load curve ID defining GAMMA3 as a function of strain rate (GAMMA3 is ignored with this option). This value is only used for FS = -1. If the first strain rate value in the curve is negative, all the strain rate values are assumed to be given as the natural logarithm of the strain rate.

Fourth Optional Strain Rate Dependence Card. (solids only!)

Card 12	1	2	3	4	5	6	7	8
Variable	LCE33C	LCE33T	LCGMS23	LCGMS31				
Type	I	I	I	I				

VARIABLE	DESCRIPTION
LCE33C	Load curve ID defining E33C as a function of strain rate (E33C is ignored with this option). If the first strain rate value in the curve is negative, all the strain rate values are assumed to be given as the natural logarithm of the strain rate.
LCE33T	Load curve ID defining E33T as a function of strain rate (E33T is ignored with this option). If the first strain rate value in the curve is negative, all the strain rate values are assumed to be given as the natural logarithm of the strain rate.

VARIABLE	DESCRIPTION
LCGMS23	Load curve ID defining GMS23 as a function of strain rate (GMS23 is ignored with this option). If the first strain rate value in the curve is negative, all the strain rate values are assumed to be given as the natural logarithm of the strain rate.
LCGMS31	Load curve ID defining GMS31 as a function of strain rate (GMS31 is ignored with this option). If the first strain rate value in the curve is negative, all the strain rate values are assumed to be given as the natural logarithm of the strain rate.

Remarks:

1. **Failure of an Element Layer.** ERODS, the maximum effective strain, controls the failure of an element layer. The maximum value of ERODS, 1, is 100% straining. The layer in the element is completely removed after the maximum effective strain (compression/tension including shear) is reached.
2. **Stress Limits.** The stress limits are factors used to limit the stress in the softening part to a given value,

$$\sigma_{\min} = \text{SLIM}_{xx} \times \text{strength.}$$

Thus, the damage value is slightly modified to achieve elastoplastic-like behavior with the threshold stress. The SLIM_{xx} fields may range between 0.0 and 1.0. With a factor of 1.0, the stress remains at a maximum value identical to the strength, similar to ideal elastoplastic behavior. A small value for SLIM_{Tx} is often reasonable for tensile failure; however, SLIM_{Cx} = 1.0 is preferred for compression. This is also valid for the corresponding shear value.

If SLIM_{xx} is smaller than 1.0, then localization can be observed depending on the total behavior of the layer. If intentionally using SLIM_{xx} < 1.0, we generally recommend avoiding a drop to zero and setting the value to something between 0.05 and 0.10. Then elastoplastic behavior is achieved in the limit, which often leads to fewer numerical problems. The defaults for SLIM_{xx} are 10⁻⁸.

3. **Crashfront.** To start the crashfront algorithm, input a value for TSIZE. Note that the time step size, with element elimination after the actual time step, becomes smaller than TSIZE.
4. **Damage.** The damage parameters can be written to the post-processing database for each integration point as the first three additional element variables and can be visualized.

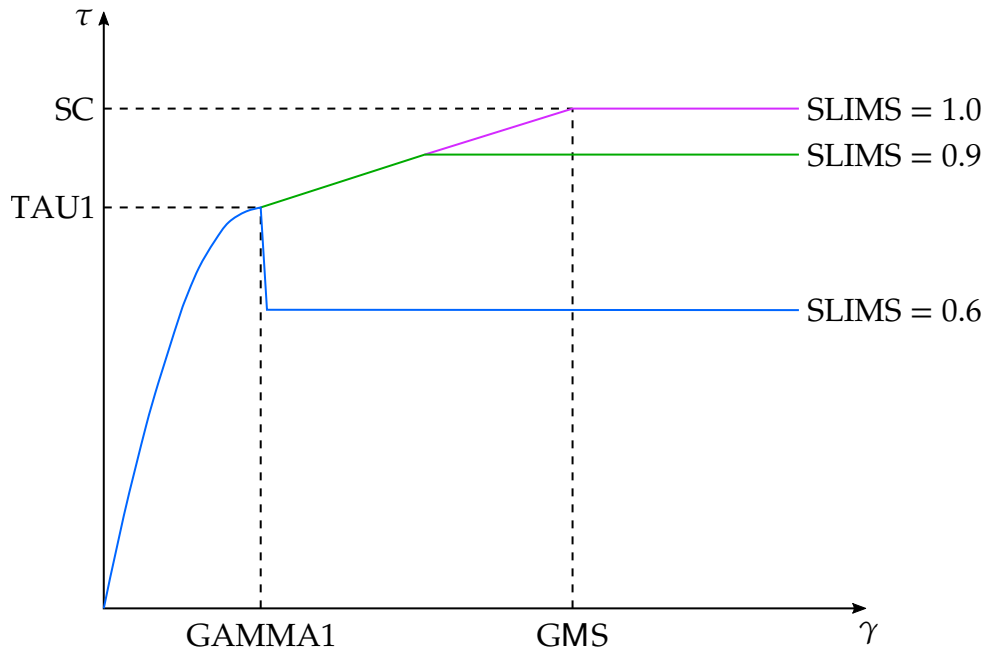

Figure M58-2. Stress-strain diagram for shear

Material models with FS = 1 or FS = -1 are better for complete laminates and fabrics, as all directions are treated similarly.

For FS = 1, the model assumes an interaction between the normal and shear stresses for damage evolution in the *a* and *b*-directions. The shear damage is always the maximum damage value from the criterion in the *a* or *b*-direction.

For FS = -1, we assume that the damage evolution is independent of any of the other stresses. The elastic material parameters and the complete structure provide the only coupling. In the tensile and compression directions, as well as in the *b*-direction, the material can have different failure surfaces. The damage values monotonically increase. Thus, a load reversal from tension to compression, or compression to tension, does not reduce damage.

- 5. **Shear Failure of Fabrics.** For fabric materials, we can assume a nonlinear stress-strain curve for the shear part for failure surface FS = -1, as given below. This is not possible for other values of FS.

Three points define the curve as shown in [Figure M58-2](#):

- a) the origin (0,0) is assumed,
- b) the limit of the first slightly nonlinear part (must be input), stress (TAU1) and strain (GAMMA1), and
- c) the shear strength at failure and shear strain at failure.

In addition, a stress limiter can be used to keep the stress constant using the SLIMS field. This value must be positive and less than or equal to 1.0. It leads to elastoplastic behavior for the shear part. The default is 10^{-8} , assuming almost brittle failure once the strength limit SC is reached.

6. **EC.** The EC field is ignored when thin shells use this material model. When used with thick shell elements of form 1, 2, or 6, a positive EC value will be used to evaluate a thickness stress. If EC is set to zero or a negative number, then the minimum of EA and EB is used for the thickness stress calculation.
7. **Strain Rate.** LS-DYNA uses the smoothed, direction-appropriate strain rate for any property specified to be strain-rate-dependent. For example, LS-DYNA uses strain rate in the *a*-direction when assessing properties in the *a*-direction. LS-DYNA, however, uses the effective strain rate when determining the rate-dependence of ERODS for load curve LCEFS.
8. **EA / EB / EC < 0.0.** If a load curve specifies the uniaxial elastic stress as a function of strain behavior, the range of the strain space (abscissa values) must span from at least 5% negative (compressive) to 5% positive (tensile) strain.

***MAT_COMPOSITE_FAILURE_OPTION_MODEL**

This is Material Type 59.

Available options include:

SHELL

SOLID

SPH

depending on the element type the material is to be used with; see *PART. An equation of state (*EOS) is optional for SPH elements and is invoked by setting EOSID to a nonzero value in *PART. If an equation of state is used, only the deviatoric stresses are calculated by the material model and the pressure is calculated by the equation of state.

Card Summary:

Card 1. This card is required.

MID	RO	EA	EB	EC	PRBA	PRCA	PRCB
-----	----	----	----	----	------	------	------

Card 2. This card is required.

GAB	GBC	GCA	KF	AOPT	MACF		
-----	-----	-----	----	------	------	--	--

Card 3. This card is required.

XP	YP	ZP	A1	A2	A3		
----	----	----	----	----	----	--	--

Card 4. This card is required.

V1	V2	V3	D1	D2	D3	BETA	
----	----	----	----	----	----	------	--

Card 5a.1. This card is included if the SHELL keyword option is used.

TSIZE	ALP	SOFT	FBRT	SR	SF		
-------	-----	------	------	----	----	--	--

Card 5a.2. This card is included if the SHELL keyword option is used.

XC	XT	YC	YT	SC			
----	----	----	----	----	--	--	--

Card 5b.1. This card is included if either the SOLID or SPH keyword option is used.

SBA	SCA	SCB	XXC	YYC	ZZC		
-----	-----	-----	-----	-----	-----	--	--

Card 5b.2. This card is included if either the SOLID or SPH keyword option is used.

XXT	YYT	ZZT						
-----	-----	-----	--	--	--	--	--	--

Data Card Definition:

Card 1	1	2	3	4	5	6	7	8
Variable	MID	RO	EA	EB	EC	PRBA	PRCA	PRCB
Type	A	F	F	F	F	F	F	F

VARIABLE

DESCRIPTION

MID	Material identification. A unique number or label must be specified (see *PART).
RO	Density
EA	E_a , Young's modulus - longitudinal direction
EB	E_b , Young's modulus - transverse direction
EC	E_c , Young's modulus - normal direction
PRBA	ν_{ba} , Poisson's ratio ba
PRCA	ν_{ca} , Poisson's ratio ca
PRCB	ν_{cb} , Poisson's ratio cb

Card 2	1	2	3	4	5	6	7	8
Variable	GAB	GBC	GCA	KF	AOPT	MACF		
Type	F	F	F	F	F	I		

VARIABLE

DESCRIPTION

GAB	G_{ab} , shear modulus
GBC	G_{bc} , shear modulus

VARIABLE	DESCRIPTION
GCA	G_{ca} , shear modulus
KF	Bulk modulus of failed material
AOPT	<p data-bbox="495 399 1429 472">Material axes option (see MAT_OPTIONTROPIC_ELASTIC, particularly the Material Directions section, for details):</p> <p data-bbox="527 493 1429 682">EQ.0.0: Locally orthotropic with material axes determined by element nodes 1, 2, and 4, as with *DEFINE_COORDINATE_NODES. For shells only, the material axes are then rotated about the normal vector to the surface of the shell by the angle BETA.</p> <p data-bbox="527 703 1429 850">EQ.1.0: Locally orthotropic with material axes determined by a point, P, in space and the global location of the element center; this is the a-direction. This option is for solid elements only.</p> <p data-bbox="527 871 1429 987">EQ.2.0: Globally orthotropic with material axes determined by vectors defined below, as with *DEFINE_COORDINATE_VECTOR</p> <p data-bbox="527 1008 1429 1627">EQ.3.0: Locally orthotropic material axes determined by a vector \mathbf{v} and the normal vector to the plane of the element. The plane of a solid element is the midsurface between the inner surface and outer surface defined by the first four nodes and the last four nodes of the connectivity of the element, respectively. Thus, for solid elements, AOPT = 3 is only available for hexahedrons. a is determined by taking the cross product of \mathbf{v} with the normal vector, b is determined by taking the cross product of the normal vector with a, and c is the normal vector. Then a and b are rotated about c by an angle BETA. BETA may be set in the keyword input for the element or in the input for this keyword. Note that for solids, the material axes may be switched depending on the choice of MACF. The switch may occur before or after applying BETA depending on the value of MACF.</p> <p data-bbox="527 1648 1429 1795">EQ.4.0: Locally orthotropic in a cylindrical coordinate system with the material axes determined by a vector \mathbf{v}, and an originating point, P, which define the centerline axis. This option is for solid elements only.</p> <p data-bbox="527 1816 1429 1900">LT.0.0: The absolute value of AOPT is a coordinate system ID number (CID on *DEFINE_COORDINATE_OPTION).</p>

VARIABLE	DESCRIPTION
----------	-------------

MACF Material axes change flag for solid elements:

EQ.-4: Switch material axes *b* and *c* before BETA rotation
 EQ.-3: Switch material axes *a* and *c* before BETA rotation
 EQ.-2: Switch material axes *a* and *b* before BETA rotation
 EQ.1: No change, default
 EQ.2: Switch material axes *a* and *b* after BETA rotation
 EQ.3: Switch material axes *a* and *c* after BETA rotation
 EQ.4: Switch material axes *b* and *c* after BETA rotation

Figure M2-2 indicates when LS-DYNA applies MACF during the process to obtain the final material axes. If BETA on *ELEMENT_-SOLID_{OPTION} is defined, then that BETA is used for the rotation for all AOPT options. Otherwise, if AOPT = 3, the BETA input on Card 4 rotates the axes. For all other values of AOPT, the material axes will be switched as specified by MACF, but no BETA rotation will be performed.

Card 3	1	2	3	4	5	6	7	8
Variable	XP	YP	ZP	A1	A2	A3		
Type	F	F	F	F	F	F		

VARIABLE	DESCRIPTION
----------	-------------

XP YP ZP Coordinates of point *p* for AOPT = 1 and 4
 A1 A2 A3 Components of vector **a** for AOPT = 2

Card 4	1	2	3	4	5	6	7	8
Variable	V1	V2	V3	D1	D2	D3	BETA	
Type	F	F	F	F	F	F	F	

VARIABLE	DESCRIPTION
V1 V2 V3	Components of vector v for AOPT = 3 and 4
D1 D2 D3	Components of vector d for AOPT = 2
BETA	Material angle in degrees for AOPT = 0 (shells only) and AOPT = 3. BETA may be overridden on the element card; see *ELEMENT_SHELL_BETA or *ELEMENT_SOLID_ORTHO.

Card 5 for SHELL Keyword Option.

Card 5a.1	1	2	3	4	5	6	7	8
Variable	TSIZE	ALP	SOFT	FBRT	SR	SF		
Type	F	F	F	F	F	F		

VARIABLE	DESCRIPTION
TSIZE	Time step for automatic element deletion
ALP	Nonlinear shear stress parameter
SOFT	Softening reduction factor for material strength in crashfront elements
FBRT	Softening of fiber tensile strength
SR	s_r , reduction factor (default = 0.447)
SF	s_f , softening factor (default = 0.0)

Card 6 for SHELL Keyword Option.

Card 5a.2	1	2	3	4	5	6	7	8
Variable	XC	XT	YC	YT	SC			
Type	F	F	F	F	F			

VARIABLE	DESCRIPTION
XC	Longitudinal compressive strength, <i>a</i> -axis (positive value)

VARIABLE	DESCRIPTION
XT	Longitudinal tensile strength, <i>a</i> -axis
YC	Transverse compressive strength, <i>b</i> -axis (positive value)
YT	Transverse tensile strength, <i>b</i> -axis
SC	Shear strength, <i>ab</i> -plane: GT.0.0: Faceted failure surface theory LT.0.0: Ellipsoidal failure surface theory

Card 5 for SPH and SOLID Keyword Options.

Card 5b.1	1	2	3	4	5	6	7	8
Variable	SBA	SCA	SCB	XXC	YYC	ZZC		
Type	F	F	F	F	F	F		

VARIABLE	DESCRIPTION
SBA	In plane shear strength
SCA	Transverse shear strength
SCB	Transverse shear strength
XXC	Longitudinal compressive strength <i>a</i> -axis (positive value)
YYC	Transverse compressive strength <i>b</i> -axis (positive value)
ZZC	Normal compressive strength <i>c</i> -axis (positive value)

Card 6 for SPH and SOLID Keyword Options.

Card 5b.2	1	2	3	4	5	6	7	8
Variable	XXT	YYT	ZZT					
Type	F	F	F					

VARIABLE	DESCRIPTION
XXT	Longitudinal tensile strength <i>a</i> -axis
YYT	Transverse tensile strength <i>b</i> -axis
ZZT	Normal tensile strength <i>c</i> -axis

***MAT_ELASTIC_WITH_VISCOSITY**

This is Material Type 60 which was developed to simulate forming of glass products (such as car windshields) at high temperatures. Deformation is by viscous flow, but elastic deformations can also be large. The material model, in which the viscosity may vary with temperature, is suitable for treating a wide range of viscous flow problems and is implemented for brick and shell elements.

Card 1	1	2	3	4	5	6	7	8
Variable	MID	R0	V0	A	B	C	LCID	
Type	A	F	F	F	F	F	F	

Card 2	1	2	3	4	5	6	7	8
Variable	PR1	PR2	PR3	PR4	PR5	PR6	PR7	PR8
Type	F	F	F	F	F	F	F	F

Card 3	1	2	3	4	5	6	7	8
Variable	T1	T2	T3	T4	T5	T6	T7	T8
Type	F	F	F	F	F	F	F	F

Card 4	1	2	3	4	5	6	7	8
Variable	V1	V2	V3	V4	V5	V6	V7	V8
Type	F	F	F	F	F	F	F	F

Card 5	1	2	3	4	5	6	7	8
Variable	E1	E2	E3	E4	E5	E6	E7	E8
Type	F	F	F	F	F	F	F	F

Card 6	1	2	3	4	5	6	7	8
Variable	ALPHA1	ALPHA2	ALPHA3	ALPHA4	ALPHA5	ALPHA6	ALPHA7	ALPHA8
Type	F	F	F	F	F	F	F	F

VARIABLE**DESCRIPTION**

MID	Material identification. A unique number or label must be specified (see *PART).
RO	Mass density
V0	Temperature independent dynamic viscosity coefficient, V_0 . If defined, the temperature dependent viscosity defined below is skipped; see type i and ii definitions for viscosity below.
A	Dynamic viscosity coefficient; see type i and ii definitions below.
B	Dynamic viscosity coefficient; see type i and ii definitions below.
C	Dynamic viscosity coefficient; see type i and ii definitions below.
LCID	Load curve (see *DEFINE_CURVE) defining viscosity as a function of temperature; see type iii. (Optional.)
T1, T2, ..., TN	Temperatures, T_i , define up to 8 values
PR1, PR2, ..., PRN	Poisson's ratios for the temperatures T_i
V1, V2, ..., VN	Corresponding dynamic viscosity coefficients (define only one if not varying with temperature)
E1, E2, ..., EN	Corresponding Young's moduli coefficients (define only one if not varying with temperature)

VARIABLE	DESCRIPTION
ALPHA1, ..., ALPHAN.	Corresponding thermal expansion coefficients

Remarks:

Volumetric behavior is treated as linear elastic. The deviatoric strain rate is considered to be the sum of elastic and viscous strain rates:

$$\dot{\epsilon}'_{\text{total}} = \dot{\epsilon}'_{\text{elastic}} + \dot{\epsilon}'_{\text{viscous}} = \frac{\dot{\sigma}'}{2G} + \frac{\sigma'}{2v} ,$$

where G is the elastic shear modulus, v is the viscosity coefficient, and bold indicates a tensor. The stress increment over one timestep dt is

$$d\sigma' = 2G\dot{\epsilon}'_{\text{total}}dt - \frac{G}{v}dt\sigma' .$$

The stress before the update is used for σ' . For shell elements the through-thickness strain rate is calculated as follows:

$$d\sigma_{33} = 0 = K(\dot{\epsilon}_{11} + \dot{\epsilon}_{22} + \dot{\epsilon}_{33})dt + 2G\dot{\epsilon}'_{33}dt - \frac{G}{v}dt\sigma'_{33} ,$$

where the subscript 33 denotes the through-thickness direction and K is the elastic bulk modulus. This leads to:

$$\begin{aligned} \dot{\epsilon}_{33} &= -a(\dot{\epsilon}_{11} + \dot{\epsilon}_{22}) + bp \\ a &= \frac{\left(K - \frac{2}{3}G\right)}{\left(K + \frac{4}{3}G\right)} \\ b &= \frac{Gdt}{v\left(K + \frac{4}{3}G\right)} \end{aligned}$$

in which p is the pressure defined as the negative of the hydrostatic stress.

The variation of viscosity with temperature can be defined in any one of the 3 ways.

- i) Constant, $V = V_0$. Do not define constants, A, B, and C, or the piecewise curve (leave Card 4 blank).
- ii) $V = V_0 \times 10^{\left(\frac{A}{T-B}+C\right)}$
- iii) Piecewise curve: define the variation of viscosity with temperature.

NOTE: Viscosity is inactive during dynamic relaxation.

***MAT_ELASTIC_WITH_VISCOSITY_CURVE**

This is Material Type 60 which was developed to simulate forming of glass products (such as car windshields) at high temperatures. Deformation is by viscous flow, but elastic deformations can also be large. The material model, in which the viscosity may vary with temperature, is suitable for treating a wide range of viscous flow problems and is implemented for brick and shell elements. Load curves are used to represent the temperature dependence of Poisson's ratio, Young's modulus, the coefficient of expansion, and the viscosity.

Card 1	1	2	3	4	5	6	7	8
Variable	MID	RO	V0	A	B	C	LCID	
Type	A	F	F	F	F	F	F	

Card 2	1	2	3	4	5	6	7	8
Variable	PR_LC	YM_LC	A_LC	V_LC	V_LOG			
Type	F	F	F	F	F			

VARIABLE**DESCRIPTION**

MID	Material identification. A unique number or label must be specified (see *PART).
RO	Mass density
V0	Temperature independent dynamic viscosity coefficient, V_0 . If defined, the temperature dependent viscosity curve, V_LC, is skipped; see type i and ii definitions for viscosity below.
A	Dynamic viscosity coefficient; see type i and ii definitions below.
B	Dynamic viscosity coefficient; see type i and ii definitions below.
C	Dynamic viscosity coefficient; see type i and ii definitions below.
LCID	Load curve (see *DEFINE_CURVE) defining factor on dynamic viscosity as a function of temperature; see type iii. (Optional).

VARIABLE	DESCRIPTION
PR_LC	Load curve (see *DEFINE_CURVE) defining Poisson's ratio as a function of temperature.
YM_LC	Load curve (see *DEFINE_CURVE) defining Young's modulus as a function of temperature.
A_LC	Load curve (see *DEFINE_CURVE) defining the coefficient of thermal expansion as a function of temperature.
V_LC	Load curve (see *DEFINE_CURVE) defining the dynamic viscosity as a function of temperature.
V_LOG	Flag for the form of V_LC: <p>EQ.1.0: The value specified in V_LC is the natural logarithm of the viscosity, $\ln V$. The value interpolated from the curve is then exponentiated to obtain the viscosity. The logarithmic form is useful if the value of the viscosity changes by orders of magnitude over the temperature range of the data.</p> <p>EQ.0.0: The value specified in V_LC is the viscosity.</p>

Remarks:

Volumetric behavior is treated as linear elastic. The deviatoric strain rate is considered to be the sum of elastic and viscous strain rates:

$$\dot{\boldsymbol{\epsilon}}'_{\text{total}} = \dot{\boldsymbol{\epsilon}}'_{\text{elastic}} + \dot{\boldsymbol{\epsilon}}'_{\text{viscous}} = \frac{\dot{\boldsymbol{\sigma}}'}{2G} + \frac{\boldsymbol{\sigma}'}{2v}$$

where G is the elastic shear modulus, v is the viscosity coefficient, and bold indicates a tensor. The stress increment over one timestep dt is

$$d\boldsymbol{\sigma}' = 2G\dot{\boldsymbol{\epsilon}}'_{\text{total}} dt - \frac{G}{v} dt \boldsymbol{\sigma}'$$

The stress before the update is used for $\boldsymbol{\sigma}'$. For shell elements the through-thickness strain rate is calculated as follows.

$$d\sigma_{33} = 0 = K(\dot{\epsilon}_{11} + \dot{\epsilon}_{22} + \dot{\epsilon}_{33})dt + 2G\dot{\epsilon}'_{33}dt - \frac{G}{v}dt\sigma'_{33}$$

where the subscript 33 denotes the through-thickness direction and K is the elastic bulk modulus. This leads to:

$$\dot{\epsilon}_{33} = -a(\dot{\epsilon}_{11} + \dot{\epsilon}_{22}) + bp$$

$$a = \frac{\left(K - \frac{2}{3}G\right)}{\left(K + \frac{4}{3}G\right)}$$
$$b = \frac{Gdt}{v\left(K + \frac{4}{3}G\right)}$$

in which p is the pressure defined as the negative of the hydrostatic stress.

The variation of viscosity with temperature can be defined in any one of the 3 ways:

- i) Constant, $V = V_0$. Do not define constants, A, B, and C, or the curve, V_LC.
- ii) $V = V_0 \times 10^{\left(\frac{A}{T-B}+C\right)}$
- iii) Piecewise curve: define the variation of viscosity with temperature.

NOTE: Viscosity is inactive during dynamic relaxation.

***MAT_KELVIN-MAXWELL_VISCOELASTIC**

This is Material Type 61. This material is a classical Kelvin-Maxwell model for modeling viscoelastic bodies, such as foams. This model is valid for solid elements only. See Remarks below.

Card 1	1	2	3	4	5	6	7	8
Variable	MID	RO	BULK	G0	GI	DC	F0	S0
Type	A	F	F	F	F	F	F	F
Default	none	none	none	none	none	0.0	0.0	0.0

VARIABLE**DESCRIPTION**

MID	Material identification. A unique number or label must be specified (see *PART).
RO	Mass density
BULK	Bulk modulus (elastic)
G0	Short-time shear modulus, G_0
GI	Long-time (infinite) shear modulus, G_∞
DC	Constant depending on formulation: FO.EQ.0.0: Maxwell decay constant FO.EQ.1.0: Kelvin relaxation constant
F0	Formulation option: EQ.0.0: Maxwell EQ.1.0: Kelvin
S0	Strain (logarithmic) output option to control what is written as component 7 to the d3plot database. (LS-PrePost always blindly labels this component as effective plastic strain.) The maximum values are updated for each element each time step: EQ.0.0: Maximum principal strain that occurs during the calculation

VARIABLE	DESCRIPTION
	EQ.1.0: Maximum magnitude of the principal strain values that occurs during the calculation
	EQ.2.0: Maximum effective strain that occurs during the calculation

Remarks:

The shear relaxation behavior is described for the Maxwell model by:

$$G(t) = G + (G_0 - G_\infty)e^{-\beta t}$$

A Jaumann rate formulation is used

$$\overset{\nabla}{\sigma}'_{ij} = 2 \int_0^t G(t - \tau) D'_{ij}(\tau) dt ,$$

where the prime denotes the deviatoric part of the stress rate, $\overset{\nabla}{\sigma}'_{ij}$, and the strain rate D_{ij} . For the Kelvin model the stress evolution equation is defined as:

$$\dot{s}_{ij} + \frac{1}{\tau} s_{ij} = (1 + \delta_{ij}) G_0 \dot{e}_{ij} + (1 + \delta_{ij}) \frac{G_\infty}{\tau} \dot{e}_{ij}$$

The strain data as written to the LS-DYNA database may be used to predict damage; see [Bandak 1991].

*MAT_VISCOUS_FOAM

This is Material Type 62. It was written to represent the Confor Foam on the ribs of EuroSID side impact dummy. It is only valid for solid elements, mainly under compressive loading.

Card 1	1	2	3	4	5	6	7	8
Variable	MID	RO	E1	N1	V2	E2	N2	PR
Type	A	F	F	F	F	F	F	F

VARIABLE

DESCRIPTION

MID	Material identification. A unique number or label must be specified (see *PART).
RO	Mass density
E1	Initial Young's modulus, E_1
N1	Exponent in power law for Young's modulus, n_1
V2	Viscous coefficient, V_2
E2	Elastic modulus for viscosity, E_2 ; see Remarks below.
N2	Exponent in power law for viscosity, n_2
PR	Poisson's ratio, ν

Remarks:

The model consists of a nonlinear elastic stiffness in parallel with a viscous damper. The elastic stiffness is intended to limit total crush while the viscosity absorbs energy. The stiffness E_2 exists to prevent timestep problems. It is used for time step calculations as long as E_1^t is smaller than E_2 . It has to be carefully chosen to take into account the stiffening effects of the viscosity. Both E_1 and V_2 are nonlinear with crush as follows:

$$E_1^t = E_1(V^{-n_1})$$

$$V_2^t = V_2|1 - V|^{n_2}$$

Here, V is the relative volume defined by the ratio of the current to initial volume. Viscosity generates a shear stress given by

$$\tau = V_2 \dot{\gamma} .$$

$\dot{\gamma}$ is the engineering shear strain rate.

Table showing typical values (units of N, mm, s):

Variable	Value
E1	0.0036
N1	4.0
V2	0.0015
E2	100.0
N2	0.2
PR	0.05

***MAT_CRUSHABLE_FOAM**

This is Material Type 63 which is dedicated to modeling crushable foam with optional damping and tension cutoff. Unloading is fully elastic. Tension is treated as elastic-perfectly-plastic at the tension cut-off value. A modified version of this model, *MAT_MODIFIED_CRUSHABLE_FOAM includes strain rate effects.

An alternative formulation for crushable foam was added in R12 and can be invoked by setting MODEL = 1 on Card 1. It incorporates an elliptical yield surface in p - q space and includes independent definitions of elastic and plastic Poisson's ratio as well as rate dependence. See further details in [Remark 2](#).

Card 1	1	2	3	4	5	6	7	8
Variable	MID	RO	E	PR	LCID	TSC	DAMP	MODEL
Type	A	F	F	F	F	F	F	I
Default	none	none	none	none	none	0.0	0.10	0

Optional card.

Card 2	1	2	3	4	5	6	7	8
Variable	PRP	K	RFILTF	BVFLAG	SRCRT	ESCAL		
Type	F	F	F	F	F	F		
Default	0.0	0.0	0.0	0.0	0.0	0.0		

VARIABLE**DESCRIPTION**

MID	Material identification. A unique number or label must be specified (see *PART).
RO	Mass density
E	Young's modulus. For MODEL = 0, E may affect contact stiffness but otherwise is not used. The final slope of curve LCID determines the elastic stiffness for loading and unloading. This slope is also used in the time step calculation. For MODEL = 1, E is really used as Young's modulus in the material law.

VARIABLE	DESCRIPTION
PR	(Elastic) Poisson's ratio
LCID	<p>MODEL.EQ.0: Load curve ID defining yield stress as a function of volumetric strain, γ (see Figure M63-1).</p> <p>MODEL.EQ.1: Load curve or table ID. If a load curve ID is specified, then the load curve defines uniaxial yield stress as a function of equivalent plastic strain. If a table ID is specified, then each strain rate references a load curve ID that gives uniaxial yield stress as a function of equivalent plastic strain.</p>
TSC	Tensile stress cutoff (only for MODEL = 0). A nonzero, positive value is strongly recommended for realistic behavior.
DAMP	Rate sensitivity via damping coefficient (.05 < recommended value < .50). Only available for MODEL = 0.
MODEL	<p>Choice of material model formulation:</p> <p>EQ.0: von Mises yield condition (default),</p> <p>EQ.1: Elliptical yield surface in p-q space.</p>
PRP	Plastic Poisson's ratio (only for MODEL = 1). PRP determines the yield potential, that is, the direction of plastic flow. It ranges from -1 to 0.5.
K	Ratio of uniaxial yield stress to hydrostatic yield stress under compression (only for MODEL = 1). K determines the shape of the yield ellipse.
RFILTF	<p>Rate filtering parameter (for MODEL = 1):</p> <p>EQ.0.0: Plastic strain rates are used if LCID is a table (default).</p> <p>GT.0.0: Filtered total strain rates are used if LCID is a table. See Remark 2.</p>
BVFLAG	<p>Bulk viscosity deactivation flag (for MODEL = 1):</p> <p>EQ.0.0: Bulk viscosity active (default).</p> <p>EQ.1.0: No bulk viscosity</p>

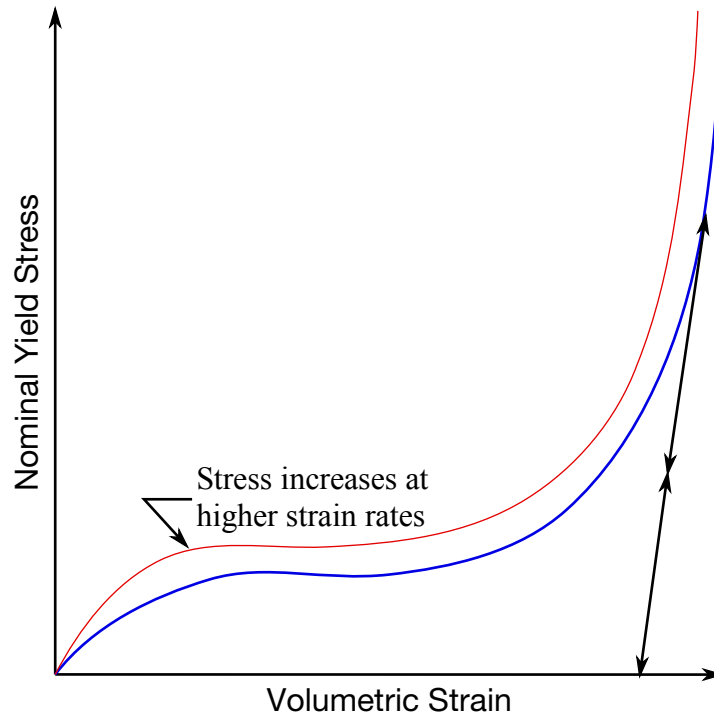

Figure M63-1. Behavior of strain rate sensitive crushable foam. Unloading is elastic to the tension cutoff. Subsequent reloading follows the unloading curve.

VARIABLE	DESCRIPTION
SRCRT	Critical stretch ratio for high compression regime (MODEL = 1). A value of 0.1 for SRCRT, for instance, means at 10% residual length an elastic stiffness is added to avoid excessive compression.
ESCAL	Scale factor for high compression stiffness as a multiple of the Young's modulus (MODEL = 1).

Remarks:

1. **Volumetric Strain.** The volumetric strain is defined in terms of the relative volume, V , as:

$$\gamma = 1 - V$$

The relative volume is defined as the ratio of the current to the initial volume. In place of the effective plastic strain in the d3plot database, the integrated volumetric strain (natural logarithm of the relative volume) is output.

2. **Elliptical Yield Surface Formulation.** An alternative formulation for crushable foam can be invoked by setting MODEL = 1. It has the following yield condition:

$$F = \sqrt{q^2 + \alpha^2 p^2} - B(\sigma^y) = 0 ,$$

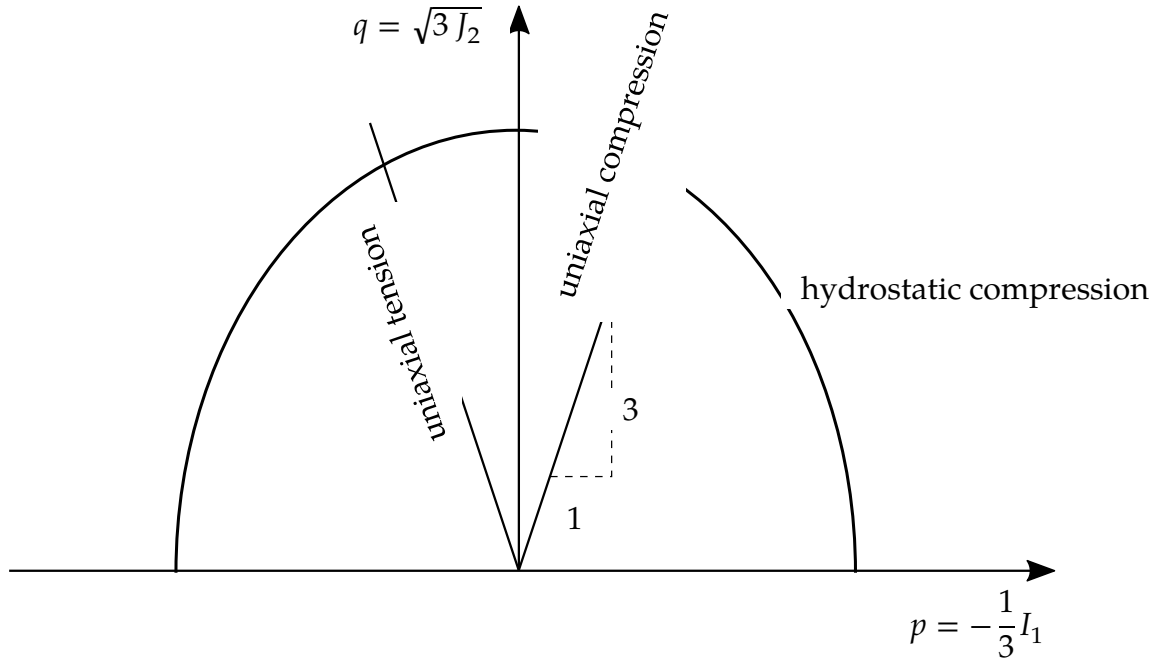

Figure M63-2. Yield surface for MODEL = 1 in p - q space

corresponding to an elliptical yield surface in the pressure (p) – deviator Mises stress (q) space; see [Figure M63-2](#). In the above yield condition,

$$\begin{aligned}
 p &= -\frac{1}{3}I_1 \\
 q &= \sqrt{3}J_2 \\
 \alpha &= \frac{3k}{\sqrt{9 - k^2}} \\
 B(\sigma^y) &= \sigma^{y, \text{uniaxial}} \sqrt{1 + \left(\frac{\alpha}{3}\right)^2}
 \end{aligned}$$

$B(\sigma^y)$, the yield stress, gives the size of the q -axis of elliptical yield surface. k , the stress ratio, is given by

$$k = \frac{\sigma_0^{y, \text{uniaxial}}}{\sigma_0^{y, \text{hydrostatic}}} .$$

k describes the shape of the yield surface and is input as field K. It ranges from 0 (von Mises) to less than 3.

For lateral straining, individual Poisson’s ratios can be defined for the elastic (PR) and the plastic (PRP) regime. The associated flow potential is given by

$$G = \sqrt{q^2 + \beta^2 p^2} - B(\sigma^y) = 0 ,$$

where

$$\beta = \frac{3}{\sqrt{2}} \sqrt{\frac{1 - 2\nu^{pl}}{1 + \nu^{pl}}}$$

with plastic Poisson's ratio ν^{pl} (PRP). Hardening is defined with yield curve or table LCID. If LCID is a yield curve, it relates uniaxial yield stress as a function of equivalent plastic strain. If LCID refers to a table, then rate dependence is taken into account. The definition of parameter RFILTF determines if plastic strain rates (RFILT = 0) or filtered total strain rates (RFILTF > 0) are used. In the latter case, exponential smoothing is used

$$\dot{\epsilon}^{avg} = \text{RFILTF} \times \dot{\epsilon}_{n-1}^{avg} + (1 - \text{RFILTF}) \times \dot{\epsilon}_n^{cur} ,$$

Thus, as RFILTF increases, more filtering is done.

***MAT_RATE_SENSITIVE_POWERLAW_PLASTICITY**

This is Material Type 64 which will model strain rate sensitive elasto-plastic material with a power law hardening. Optionally, the coefficients can be defined as functions of the effective plastic strain.

Card 1	1	2	3	4	5	6	7	8
Variable	MID	RO	E	PR	K	M	N	E0
Type	A	F	F	F	F	F	F	F
Default	none	none	none	none	none	0.0001	none	0.0002

Card 2	1	2	3	4	5	6	7	8
Variable	VP	EPS0	RFILTF					
Type	F	F	F					
Default	0.0	1.0	0.0					

VARIABLE**DESCRIPTION**

MID	Material identification. A unique number or label must be specified (see *PART).
RO	Mass density
E	Young's modulus of elasticity
PR	Poisson's ratio
K	Material constant, k . If $K < 0$, the absolute value of K is taken as the load curve number that defines k as a function of effective plastic strain.
M	Strain hardening coefficient, m . If $M < 0$, the absolute value of M is taken as the load curve number that defines m as a function of effective plastic strain.

VARIABLE	DESCRIPTION
N	Strain rate sensitivity coefficient, n . If $N < 0$, the absolute value of N is taken as the load curve number that defines n as a function of effective plastic strain.
E0	Initial strain rate (default = 0.0002)
VP	Formulation for rate effects: EQ.0.0: Scale yield stress (default) EQ.1.0: Viscoplastic formulation
EPS0	Quasi-static threshold strain rate. See description under *MAT_015.
RFILTF	Smoothing factor on the effective strain rate for solid elements when $VP = 0$:

$$\dot{\varepsilon}_n^{\text{avg}} = \text{RFILTF} \times \dot{\varepsilon}_{n-1}^{\text{avg}} + (1 - \text{RFILTF}) \times \dot{\varepsilon}_n$$

Remarks:

1. **Constitutive Relationship.** This material model follows a constitutive relationship of the form:

$$\sigma = k \varepsilon^m \dot{\varepsilon}^n ,$$

where σ is the yield stress, ε is the effective plastic strain, and $\dot{\varepsilon}$ is the effective total strain rate ($VP = 0$), or the effective plastic strain rate ($VP = 1$). The constants k , m , and n can be expressed as functions of effective plastic strain or can be constant with respect to the plastic strain. The case of no strain hardening can be obtained by setting the exponent of the plastic strain equal to a very small positive value, such as 0.0001.

The initial yield stress is obtained through:

$$\sigma_0 = k \varepsilon_0^m \dot{\varepsilon}^n ,$$

with an initial effective strain of

$$\varepsilon_0 = \max \left(0.001, \left(\frac{E}{k \dot{\varepsilon}^n} \right)^{1/(m-1)} \right) .$$

2. **Superplastic Forming.** This model can be combined with the superplastic forming input (see *LOAD_SUPERPLASTIC_FORMING) to control the magnitude of the pressure in the pressure boundary conditions. Controlling the pressure limits the effective plastic strain rate so that it does not exceed a maximum value at any integration point within the model.

3. **Viscoplastic Formulation.** A fully viscoplastic formulation is optional. An additional cost is incurred, but the improvement in results can be dramatic.

*MAT_MODIFIED_ZERILLI_ARMSTRONG

This is Material Type 65 which is a rate and temperature sensitive plasticity model that is sometimes preferred in ordnance design calculations.

Card 1	1	2	3	4	5	6	7	8
Variable	MID	RO	G	E0	N	TROOM	PC	SPALL
Type	A	F	F	F	F	F	F	F

Card 2	1	2	3	4	5	6	7	8
Variable	C1	C2	C3	C4	C5	C6	EFAIL	VP
Type	F	F	F	F	F	F	F	F

Card 3	1	2	3	4	5	6	7	8
Variable	B1	B2	B3	G1	G2	G3	G4	BULK
Type	F	F	F	F	F	F	F	F

Optional FCC Metal Card. This card is optional.

Card 4	1	2	3	4	5	6	7	8
Variable	M							
Type	F							

VARIABLE

DESCRIPTION

MID	Material identification. A unique number or label must be specified (see *PART).
RO	Mass density
G	Shear modulus

VARIABLE	DESCRIPTION
E0	$\dot{\epsilon}_0$, factor to normalize strain rate
N	n , exponent for bcc metal
TROOM	T_r , room temperature
PC	p_0 , Pressure cutoff
SPALL	Spall Type: EQ.1.0: minimum pressure limit EQ.2.0: maximum principal stress EQ.3.0: minimum pressure cutoff
C_i	C_i , coefficients for flow stress; see Remark 1 below.
EFAIL	Failure strain for erosion
VP	Formulation for rate effects: EQ.0.0: scale yield stress (default) EQ.1.0: viscoplastic formulation
B_i	B_i , coefficients for polynomial to represent temperature dependency of flow stress yield
G_i	G_i , coefficients for defining heat capacity and temperature dependency of heat capacity
BULK	Bulk modulus defined for shell elements only. Do not input for solid elements.
M	m , exponent for FCC metal (default = 0.5). This field is only used when N = 0.0 on Card 1.

Remarks:

1. **Flow Stress.** The Zerilli-Armstrong Material Model expresses the flow stress as follows.
 - a) For FCC metals ($n = 0$),

$$\sigma = C_1 + \{C_2(\epsilon^p)^m [e^{[-C_3+C_4\ln(\epsilon^*)]T}] + C_5\} \left[\frac{\mu(T)}{\mu(293)} \right],$$

where ϵ^p is the effective plastic strain and $\dot{\epsilon}^*$ is the effective plastic strain rate defined as

$$\dot{\epsilon}^* = \frac{\dot{\epsilon}}{\dot{\epsilon}_0} .$$

$\dot{\epsilon}_0 = 1, 10^{-3}, 10^{-6}$ for time units of seconds, milliseconds, and microseconds, respectively.

b) For BCC metals ($n > 0$),

$$\sigma = C_1 + C_2 e^{[-C_3 + C_4 \ln(\dot{\epsilon}^*)]T} + [C_5 (\epsilon^p)^n + C_6] \left[\frac{\mu(T)}{\mu(293)} \right] ,$$

where

$$\frac{\mu(T)}{\mu(293)} = B_1 + B_2 T + B_3 T^2 .$$

2. **Heat Capacity.** The relationship between heat capacity (specific heat) and temperature may be characterized by a cubic polynomial equation as follows:

$$C_p = G_1 + G_2 T + G_3 T^2 + G_4 T^3$$

3. **Viscoplastic Formulation.** A fully viscoplastic formulation is optional. An additional cost is incurred but the improvement in results can be dramatic.

***MAT_LINEAR_ELASTIC_DISCRETE_BEAM**

This is Material Type 66. This material model is defined for simulating the effects of a linear elastic beam by using six springs each acting about one of the six local degrees-of-freedom. The two nodes defining a beam may be coincident to give a zero length beam or offset to give a finite length beam. For finite length discrete beams the absolute value of the variable SCOOR in the *SECTION_BEAM input should be set to a value of 2.0, which causes the local r -axis to be aligned along the two nodes of the beam, to give physically correct behavior. The distance between the nodes of a beam should not affect the behavior of this model. A triad is used to orient the beam for the directional springs. Translational/rotational stiffness and viscous damping effects are considered for a local cartesian system; see [Remark 1](#). Applications for this element include the modeling of joint stiffnesses.

Card 1	1	2	3	4	5	6	7	8
Variable	MID	RO	TKR	TKS	TKT	RKR	RKS	RKT
Type	A	F	F	F	F	F	F	F

Card 2	1	2	3	4	5	6	7	8
Variable	TDR	TDS	TDT	RDR	RDS	RDT		
Type	F	F	F	F	F	F		

Card 3	1	2	3	4	5	6	7	8
Variable	FOR	FOS	FOT	MOR	MOS	MOT		
Type	F	F	F	F	F	F		

VARIABLE**DESCRIPTION**

MID	Material identification. A unique number or label must be specified (see *PART).
RO	Mass density; see also "volume" in the *SECTION_BEAM definition.

VARIABLE	DESCRIPTION
TKR	Translational stiffness along local r -axis; see Remarks 1 and 2 below.
TKS	Translational stiffness along local s -axis
TKT	Translational stiffness along local t -axis
RKR	Rotational stiffness about the local r -axis
RKS	Rotational stiffness about the local s -axis
RKT	Rotational stiffness about the local t -axis
TDR	Translational viscous damper along local r -axis (optional)
TDS	Translational viscous damper along local s -axis (optional)
TDT	Translational viscous damper along local t -axis (optional)
RDR	Rotational viscous damper about the local r -axis (optional)
RDS	Rotational viscous damper about the local s -axis (optional)
RDT	Rotational viscous damper about the local t -axis (optional)
FOR	Preload force in r -direction (optional)
FOS	Preload force in s -direction (optional)
FOT	Preload force in t -direction (optional)
MOR	Preload moment about r -axis (optional)
MOS	Preload moment about s -axis (optional)
MOT	Preload moment about t -axis (optional)

Remarks:

- Coordinate System and Orientation.** The formulation of the discrete beam (type 6) assumes that the beam is of zero length and requires no orientation node. A small distance between the nodes joined by the beam is permitted. The local coordinate system which determines (r, s, t) is given by the coordinate ID (see *DEFINE_COORDINATE_OPTION) in the cross-sectional input (see *SECTION_BEAM), where the global system is the default. The local coordinate

system axes can rotate with either node of the beam or an average rotation of both nodes (see SCOOR variable in *SECTION_BEAM).

2. **Null Stiffness.** For null stiffness coefficients, no forces corresponding to these null values will develop. The viscous damping coefficients are optional.
3. **Rotational Displacement.** Rotational displacement is measured in radians.

*MAT_NONLINEAR_ELASTIC_DISCRETE_BEAM

This is Material Type 67. This material model is defined for simulating the effects of non-linear elastic and nonlinear viscous beams by using six springs each acting about one of the six local degrees-of-freedom. The two nodes defining a beam may be coincident to give a zero length beam or offset to give a finite length beam. For finite length discrete beams the absolute value of the variable SCOOR in the *SECTION_BEAM input should be set to a value of 2.0, which aligns the local r-axis along the two nodes of the beam to give physically correct behavior. The distance between the nodes of a beam should not affect the behavior of this material model. A triad is used to orient the beam for the directional springs. Arbitrary curves to model transitional/ rotational stiffness and damping effects are allowed. See remarks below.

Card Summary:

Card 1. This card is required.

MID	RO	LCIDTR	LCIDTS	LCIDTT	LCIDRR	LCIDRS	LCIDRT
-----	----	--------	--------	--------	--------	--------	--------

Card 2. This card is required.

LCIDTDR	LCIDTDS	LCIDTDT	LCIDRDR	LCIDRDS	LCIDRDT		
---------	---------	---------	---------	---------	---------	--	--

Card 3. This card is required.

FOR	FOS	FOT	MOR	MOS	MOT		
-----	-----	-----	-----	-----	-----	--	--

Card 4. To consider failure, this card must be defined. Otherwise it is optional.

FFAILR	FFAILS	FFAILT	MFAILR	MFAILS	MFAILT		
--------	--------	--------	--------	--------	--------	--	--

Card 5. To consider failure, this card must be defined. Otherwise it is optional.

UFAILR	UFAILS	UFAILT	TFAILR	TFAILS	TFAILT		
--------	--------	--------	--------	--------	--------	--	--

Data Card Definitions:

Card 1	1	2	3	4	5	6	7	8
Variable	MID	RO	LCIDTR	LCIDTS	LCIDTT	LCIDRR	LCIDRS	LCIDRT
Type	A	F	F	F	F	F	F	F

VARIABLE	DESCRIPTION
MID	Material identification. A unique number or label must be specified (see *PART).
RO	Mass density; see also volume in *SECTION_BEAM.
LCIDTR	Load curve ID defining translational force resultant along local r -axis as a function of relative translational displacement; see Remarks 1 and 3 and Figure M67-1 .
LCIDTS	Load curve ID defining translational force resultant along local s -axis as a function of relative translational displacement.
LCIDTT	Load curve ID defining translational force resultant along local t -axis as a function of relative translational displacement.
LCIDRR	Load curve ID defining rotational moment resultant about local r -axis as a function of relative rotational displacement.
LCIDRS	Load curve ID defining rotational moment resultant about local s -axis as a function of relative rotational displacement.
LCIDRT	Load curve ID defining rotational moment resultant about local t -axis as a function of relative rotational displacement.

Card 2	1	2	3	4	5	6	7	8
Variable	LCIDTDR	LCIDTDS	LCIDTDT	LCIDRDR	LCIDRDS	LCIDRDT		
Type	F	F	F	F	F	F		

VARIABLE	DESCRIPTION
LCIDTDR	Load curve ID defining translational damping force resultant along local r -axis as a function of relative translational velocity.
LCIDTDS	Load curve ID defining translational damping force resultant along local s -axis as a function of relative translational velocity.
LCIDTDT	Load curve ID defining translational damping force resultant along local t -axis as a function of relative translational velocity.
LCIDRDR	Load curve ID defining rotational damping moment resultant about local r -axis as a function of relative rotational velocity.

VARIABLE**DESCRIPTION**

LCIDRDS	Load curve ID defining rotational damping moment resultant about local s -axis as a function of relative rotational velocity.							
LCIDRDT	Load curve ID defining rotational damping moment resultant about local t -axis as a function of relative rotational velocity.							

Card 3	1	2	3	4	5	6	7	8
Variable	FOR	FOS	FOT	MOR	MOS	MOT		
Type	F	F	F	F	F	F		

VARIABLE**DESCRIPTION**

FOR	Preload force in r -direction (optional).
FOS	Preload force in s -direction (optional).
FOT	Preload force in t -direction (optional).
MOR	Preload moment about r -axis (optional).
MOS	Preload moment about s -axis (optional).
MOT	Preload moment about t -axis (optional).

Card 4	1	2	3	4	5	6	7	8
Variable	FFAILR	FFAILS	FFAILT	MFAILR	MFAILS	MFAILT		
Type	F	F	F	F	F	F		
Default	0.0	0.0	0.0	0.0	0.0	0.0		

VARIABLE**DESCRIPTION**

FFAILR	Optional failure parameter. If zero, the corresponding force, F_r , is not considered in the failure calculation. See Remark 4 .
--------	--

VARIABLE	DESCRIPTION
FFAILS	Optional failure parameter. If zero, the corresponding force, F_s , is not considered in the failure calculation.
FFAILT	Optional failure parameter. If zero, the corresponding force, F_t , is not considered in the failure calculation.
MFAILR	Optional failure parameter. If zero, the corresponding moment, M_r , is not considered in the failure calculation.
MFAILS	Optional failure parameter. If zero, the corresponding moment, M_s , is not considered in the failure calculation.
MFAILT	Optional failure parameter. If zero, the corresponding moment, M_t , is not considered in the failure calculation.

Card 5	1	2	3	4	5	6	7	8
Variable	UFAILR	UFAILS	UFAILT	TFAILR	TFAILS	TFAILT		
Type	F	F	F	F	F	F		
Default	0.0	0.0	0.0	0.0	0.0	0.0		

VARIABLE	DESCRIPTION
UFAILR	Optional failure parameter. If zero, the corresponding displacement, u_r , is not considered in the failure calculation. See Remark 4 .
UFAILS	Optional failure parameter. If zero, the corresponding displacement, u_s , is not considered in the failure calculation.
UFAILT	Optional failure parameter. If zero, the corresponding displacement, u_t , is not considered in the failure calculation.
TFAILR	Optional failure parameter. If zero, the corresponding rotation, θ_r , is not considered in the failure calculation.
TFAILS	Optional failure parameter. If zero, the corresponding rotation, θ_s , is not considered in the failure calculation.

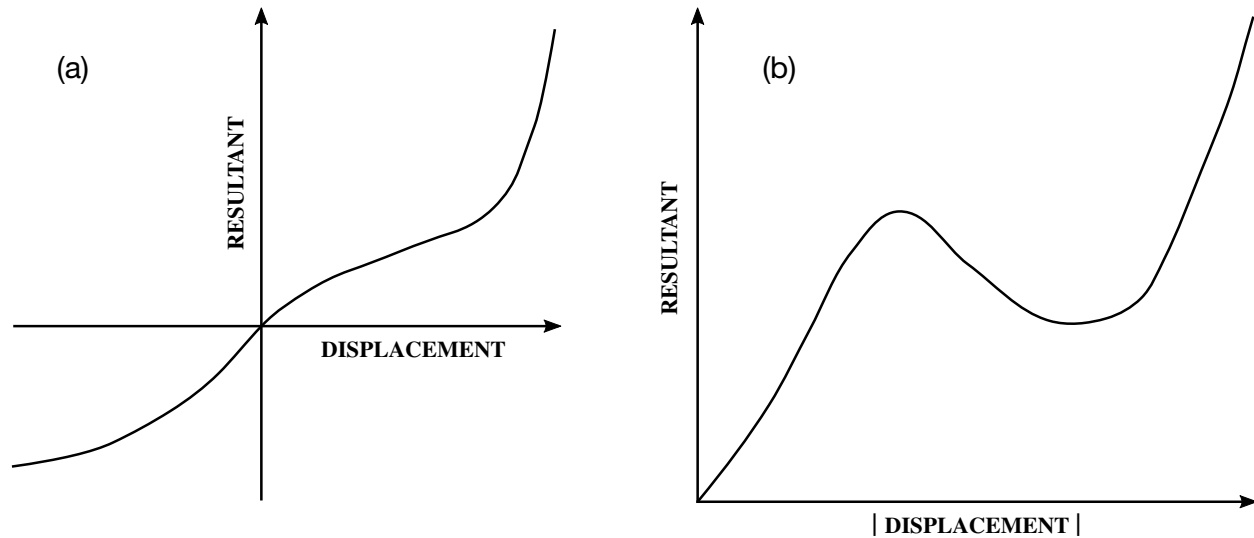

Figure M67-1. The resultant forces and moments are determined by a table lookup. If the origin of the load curve is at [0,0] as in (b) and tension and compression responses are symmetric.

VARIABLE	DESCRIPTION
TFAILT	Optional failure parameter. If zero, the corresponding rotation, θ_t , is not considered in the failure calculation.

Remarks:

- 1. Null Load Curve IDs.** For null load curve IDs, no forces are computed.
- 2. Discrete Beam Formulation.** The formulation of the discrete beam (type 6) assumes that the beam is of zero length and requires no orientation node. A small distance between the nodes joined by the beam is permitted. The local coordinate system which determines (r, s, t) is given by the coordinate ID (see *DEFINE_COORDINATE_OPTION) in the cross-sectional input (see *SECTION_BEAM) where the global system is the default. The local coordinate system axes can rotate with either node of the beam or an average rotation of both nodes (see SCOOR variable in *SECTION_BEAM).
- 3. Tension and Compression.** If different behavior in tension and compression is desired in the calculation of the force resultants, the load curve(s) must be defined in the negative quadrant starting with the most negative displacement then increasing monotonically to the most positive. If the load curve behaves similarly in tension and compression, define only the positive quadrant. Whenever displacement values fall outside of the defined range, the resultant forces will be extrapolated. [Figure M67-1](#) depicts a typical load curve for a force resultant. Load curves used for determining the damping forces and moment resultants always act identically in tension and compression, since only the

positive quadrant values are considered, that is, start the load curve at the origin [0,0].

4. **Failure.** Catastrophic failure based on force resultants occurs if the following inequality is satisfied.

$$\left(\frac{F_r}{F_r^{\text{fail}}}\right)^2 + \left(\frac{F_s}{F_s^{\text{fail}}}\right)^2 + \left(\frac{F_t}{F_t^{\text{fail}}}\right)^2 + \left(\frac{M_r}{M_r^{\text{fail}}}\right)^2 + \left(\frac{M_s}{M_s^{\text{fail}}}\right)^2 + \left(\frac{M_t}{M_t^{\text{fail}}}\right)^2 - 1. \geq 0 .$$

After failure the discrete element is deleted. Likewise, catastrophic failure based on displacement resultants occurs if the following inequality is satisfied:

$$\left(\frac{u_r}{u_r^{\text{fail}}}\right)^2 + \left(\frac{u_s}{u_s^{\text{fail}}}\right)^2 + \left(\frac{u_t}{u_t^{\text{fail}}}\right)^2 + \left(\frac{\theta_r}{\theta_r^{\text{fail}}}\right)^2 + \left(\frac{\theta_s}{\theta_s^{\text{fail}}}\right)^2 + \left(\frac{\theta_t}{\theta_t^{\text{fail}}}\right)^2 - 1. \geq 0 .$$

After failure, the discrete element is deleted. If failure is included, either or both of the criteria may be used.

5. **Rotational Displacement.** Rotational displacement is measured in radians.

*MAT_NONLINEAR_PLASTIC_DISCRETE_BEAM

This is Material Type 68. This material model is for simulating the effects of nonlinear elastoplastic, linear viscous behavior of beams by using six springs each acting about one of the six local degrees-of-freedom. The two nodes defining a beam may be coincident to give a zero length beam or offset to give a finite length beam. For finite length discrete beams, the absolute value of the variable SCOOR in the *SECTION_BEAM input should be set to a value of 2.0, which aligns the local r-axis along the two nodes of the beam to give physically correct behavior. The distance between the nodes of a beam should not affect the behavior of this material model. A triad orients the beam for the directional springs. Translational/rotational stiffness and damping effects can be considered. The plastic behavior is modeled using force/moment curves as a function of displacements/rotation. Optionally, failure can be specified based on a force/moment criterion and a displacement rotation criterion. See also the remarks below.

Card Summary:

Card 1. This card is required

MID	RO	TKR	TKS	TKT	RKR	RKS	RKT
-----	----	-----	-----	-----	-----	-----	-----

Card 2. This card is required.

TDR	TDS	TDT	RDR	RDS	RDT	RYLD	
-----	-----	-----	-----	-----	-----	------	--

Card 3. This card is required.

LCPDR	LCPDS	LCPDT	LCPMR	LCPMS	LCPMT		
-------	-------	-------	-------	-------	-------	--	--

Card 4. This card is optional.

FFAILR	FFAILS	FFAILT	MFAILR	MFAILS	MFAILT		
--------	--------	--------	--------	--------	--------	--	--

Card 5. This card is optional.

UFAILR	UFAILS	UFAILT	TFAILR	TFAILS	TFAILT		
--------	--------	--------	--------	--------	--------	--	--

Card 6. This card is optional.

FOR	FOS	FOT	MOR	MOS	MOT		
-----	-----	-----	-----	-----	-----	--	--

Data Card Definitions:

Card 1	1	2	3	4	5	6	7	8
Variable	MID	RO	TKR	TKS	TKT	RKR	RKS	RKT
Type	A	F	F	F	F	F	F	F
Default	none	none	none	none	none	none	none	none

VARIABLE**DESCRIPTION**

MID	Material identification. A unique number or label must be specified (see *PART).
RO	Mass density; see also volume on *SECTION_BEAM definition.
TKR	Translational stiffness along local r -axis LT.0.0: TKR is the load curve ID defining the elastic translational force along the local r -axis as a function of relative translational displacement. Useful for nonlinear elastic behavior.
TKS	Translational stiffness along local s -axis LT.0.0: TKS is the load curve ID for defining the elastic translational force along the local s -axis as a function of relative translational displacement. Useful for nonlinear elastic behavior.
TKT	Translational stiffness along local t -axis LT.0.0: TKT is the load curve ID defining the elastic translational force along the local t -axis as a function of relative translational displacement. Useful for nonlinear elastic behavior.
RKR	Rotational stiffness about the local r -axis LT.0.0: RKR is the load curve ID defining the elastic rotational moment along the local r -axis as a function of relative rotational displacement. Useful for nonlinear elastic behavior.

VARIABLE	DESCRIPTION
----------	-------------

- | | |
|-----|---|
| RKS | Rotational stiffness about the local <i>s</i> -axis

LT.0.0: RKS is the load curve ID defining the elastic rotational moment along the local <i>s</i> -axis as a function of relative rotational displacement. Useful for nonlinear elastic behavior. |
| RKT | Rotational stiffness about the local <i>t</i> -axis

LT.0.0: RKT is the load curve ID defining the elastic rotational moment along the local <i>t</i> -axis as a function of relative rotational displacement. Useful for nonlinear elastic behavior. |

Card 2	1	2	3	4	5	6	7	8
Variable	TDR	TDS	TDT	RDR	RDS	RDT	RYLD	
Type	F	F	F	F	F	F	I	
Default	none	none	none	none	none	none	0	

VARIABLE	DESCRIPTION
----------	-------------

- | | |
|------|--|
| TDR | Translational viscous damper along local <i>r</i> -axis |
| TDS | Translational viscous damper along local <i>s</i> -axis |
| TDT | Translational viscous damper along local <i>t</i> -axis |
| RDR | Rotational viscous damper about the local <i>r</i> -axis |
| RDS | Rotational viscous damper about the local <i>s</i> -axis |
| RDT | Rotational viscous damper about the local <i>t</i> -axis |
| RYLD | Flag for method of computing plastic yielding:

EQ.0: Original method of determining plastic yielding (default)
EQ.1: Compute yield displacement/rotation by taking the first point of the relevant curve as the yield force/moment and dividing it by the relevant stiffness |

Card 3	1	2	3	4	5	6	7	8
Variable	LCPDR	LCPDS	LCPDT	LCPMR	LCPMS	LCPMT		
Type	I	I	I	I	I	I		
Default	0	0	0	0	0	0		

VARIABLE**DESCRIPTION**

LCPDR	Load curve (or table) ID for yield force as a function of plastic displacement along the local r -axis (and translational velocity in the r -direction, if table). If the curve/table ID is zero, and TKR is non-zero, then elastic behavior is obtained for this component.
LCPDS	Load curve (or table) ID-yield force as a function of plastic displacement along the s -axis (and translational velocity in the s -direction, if table). If the curve/table ID is zero, and TKS is nonzero, then elastic behavior is obtained for this component.
LCPDT	Load curve (or table) ID-yield force as a function of plastic displacement along the t -axis (and translational velocity in the t -direction, if table). If the curve/table ID is zero, and TKT is nonzero, then elastic behavior is obtained for this component.
LCPMR	Load curve (or table) ID-yield moment as a function of plastic rotation about the r -axis (and rotational velocity about the r -axis, if table). If the curve/table ID is zero, and RKR is nonzero, then elastic behavior is obtained for this component.
LCPMS	Load curve (or table) ID-yield moment as a function of plastic rotation about the s -axis (and rotational velocity about the s -axis, if table). If the curve/table ID is zero, and RKS is nonzero, then elastic behavior is obtained for this component.
LCPMT	Load curve (or table) ID-yield moment as a function of plastic rotation about the t -axis (and rotational velocity about the t -axis, if table). If the curve/table ID is zero, and RKT is nonzero, then elastic behavior is obtained for this component.

Card 4	1	2	3	4	5	6	7	8
Variable	FFAILR	FFAILS	FFAILT	MFAILR	MFAILS	MFAILT		
Type	F	F	F	F	F	F		
Default	0.0	0.0	0.0	0.0	0.0	0.0		

VARIABLE**DESCRIPTION**

FFAILR

Optional failure parameter. If zero, the corresponding force, F_r , is not considered in the failure calculation.

LT.0.0: |FFAILR| is the load curve ID defining F_r as a function of translational velocity along the local r -axis.

FFAILS

Optional failure parameter. If zero, the corresponding force, F_s , is not considered in the failure calculation.

LT.0.0: |FFAILS| is the load curve ID defining F_s as a function of translational velocity along the local s -axis.

FFAILT

Optional failure parameter. If zero, the corresponding force, F_t , is not considered in the failure calculation.

LT.0.0: |FFAILT| is the load curve ID defining F_t as a function of translational velocity along the local t -axis.

MFAILR

Optional failure parameter. If zero, the corresponding moment, M_r , is not considered in the failure calculation.

LT.0.0: |MFAILR| is the load curve ID defining M_r as a function of rotational velocity about the local r -axis.

MFAILS

Optional failure parameter. If zero, the corresponding moment, M_s , is not considered in the failure calculation.

LT.0.0: |MFAILS| is the load curve ID defining M_s as a function of rotational velocity about the local s -axis.

MFAILT

Optional failure parameter. If zero, the corresponding moment, M_t , is not considered in the failure calculation.

LT.0.0: |MFAILT| is the load curve ID defining M_t as a function of rotational velocity about the local t -axis.

Card 5	1	2	3	4	5	6	7	8
Variable	UFAILR	UFAILS	UFAILT	TFAILR	TFAILS	TFAILT		
Type	F	F	F	F	F	F		
Default	0.0	0.0	0.0	0.0	0.0	0.0		

VARIABLE**DESCRIPTION**

UFAILR

Optional failure parameter. If zero, the corresponding displacement, u_r , is not considered in the failure calculation.

LT.0.0: |UFAILR| is the load curve ID defining u_r as a function of translational velocity along the local r -axis.

UFAILS

Optional failure parameter. If zero, the corresponding displacement, u_s , is not considered in the failure calculation.

LT.0.0: |UFAILS| is the load curve ID defining u_s as a function of translational velocity along the local s -axis.

UFAILT

Optional failure parameter. If zero, the corresponding displacement, u_t , is not considered in the failure calculation.

LT.0.0: |UFAILT| is the load curve ID defining u_t as a function of translational velocity along the local t -axis.

TFAILR

Optional failure parameter. If zero, the corresponding rotation, θ_r , is not considered in the failure calculation.

LT.0.0: |TFAILR| is the load curve ID defining θ_r as a function of rotational velocity about the local r -axis.

TFAILS

Optional failure parameter. If zero, the corresponding rotation, θ_s , is not considered in the failure calculation.

LT.0.0: |TFAILS| is the load curve ID defining θ_s as a function of rotational velocity about the local s -axis.

TFAILT

Optional failure parameter. If zero, the corresponding rotation, θ_t , is not considered in the failure calculation.

LT.0.0: |TFAILT| is the load curve ID defining θ_t as a function of rotational velocity about the local t -axis.

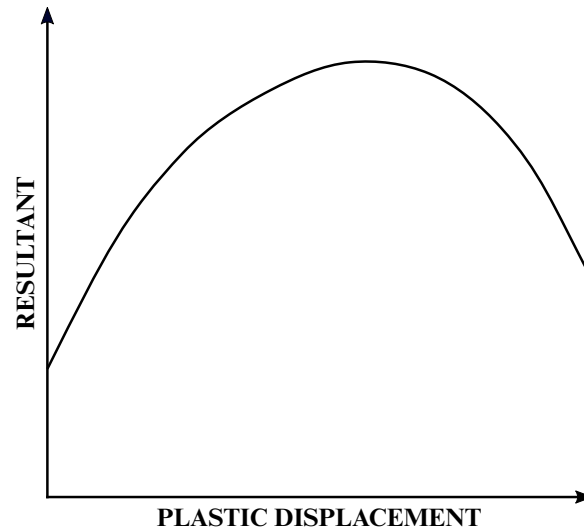

Figure M68-1. The resultant forces and moments are limited by the yield definition. The initial yield point corresponds to a plastic displacement of zero.

Card 6	1	2	3	4	5	6	7	8
Variable	FOR	FOS	FOT	MOR	MOS	MOT		
Type	F	F	F	F	F	F		

VARIABLE

DESCRIPTION

FOR	Preload force in r -direction (optional)
FOS	Preload force in s -direction (optional)
FOT	Preload force in t -direction (optional)
MOR	Preload moment about r -axis (optional)
MOS	Preload moment about s -axis (optional)
MOT	Preload moment about t -axis (optional)

Remarks:

1. **Elastic Behavior.** For the translational and rotational degrees of freedom where elastic behavior is desired, set the load curve ID to zero.

2. **Plastic Displacement.** The plastic displacement for the load curves is defined as:

$$\text{plastic displacement} = \text{total displacement} - \text{yield force/elastic stiffness} .$$

3. **Discrete Beam Formulation.** The formulation of the discrete beam (type 6) assumes that the beam is of zero length and requires no orientation node. A small distance between the nodes joined by the beam is permitted. The local coordinate system which determines (r, s, t) is given by the coordinate ID (see *DEFINE_COORDINATE_OPTION) in the cross-sectional input (see *SECTION_BEAM) where the global system is the default. The local coordinate system axes can rotate with either node of the beam or an average rotation of both nodes (see SCOOR variable in *SECTION_BEAM).

4. **Failure.** Catastrophic failure based on force resultants occurs if the following inequality is satisfied.

$$\left(\frac{F_r}{F_r^{\text{fail}}}\right)^2 + \left(\frac{F_s}{F_s^{\text{fail}}}\right)^2 + \left(\frac{F_t}{F_t^{\text{fail}}}\right)^2 + \left(\frac{M_r}{M_r^{\text{fail}}}\right)^2 + \left(\frac{M_s}{M_s^{\text{fail}}}\right)^2 + \left(\frac{M_t}{M_t^{\text{fail}}}\right)^2 - 1. \geq 0.$$

After failure, the discrete element is deleted. Likewise, catastrophic failure based on displacement resultants occurs if the following inequality is satisfied:

$$\left(\frac{u_r}{u_r^{\text{fail}}}\right)^2 + \left(\frac{u_s}{u_s^{\text{fail}}}\right)^2 + \left(\frac{u_t}{u_t^{\text{fail}}}\right)^2 + \left(\frac{\theta_r}{\theta_r^{\text{fail}}}\right)^2 + \left(\frac{\theta_s}{\theta_s^{\text{fail}}}\right)^2 + \left(\frac{\theta_t}{\theta_t^{\text{fail}}}\right)^2 - 1. \geq 0.$$

After failure the discrete element is deleted. If failure is included, either or both of the criteria may be used.

5. **Rotational Displacement.** Rotational displacement is measured in radians.

***MAT_SID_DAMPER_DISCRETE_BEAM**

This is Material Type 69. The side impact dummy uses a damper that is not adequately treated by the nonlinear force as a function of relative velocity curves since the force characteristics are dependent on the displacement of the piston. See Remarks below.

Card Summary:

Card 1. This card is required.

MID	RO	ST	D	R	H	K	C
-----	----	----	---	---	---	---	---

Card 2. This card is required.

C3	STF	RHOF	C1	C2	LCIDF	LCIDD	S0
----	-----	------	----	----	-------	-------	----

Card 3. Include one card per orifice. Read in up to 15 orifice locations. The next keyword ("*") card terminates this input.

ORFLOC	ORFRAD	SF	DC				
--------	--------	----	----	--	--	--	--

Data Card Definitions:

Card 1	1	2	3	4	5	6	7	8
Variable	MID	RO	ST	D	R	H	K	C
Type	A	F	F	F	F	F	F	F

VARIABLE**DESCRIPTION**

MID	Material identification. A unique number or label must be specified (see *PART).
RO	Mass density; see also volume on *SECTION_BEAM definition.
ST	S_t , piston stroke. S_t must equal or exceed the length of the beam element; see Figure M69-1 below.
D	d , piston diameter
R	R , default orifice radius
H	h , orifice controller position

VARIABLE	DESCRIPTION
-----------------	--------------------

K	<p>K, damping constant</p> <p>LT.0.0: K is the load curve number ID (see *DEFINE_CURVE) defining the damping coefficient as a function of the absolute value of the relative velocity.</p>
C	C , discharge coefficient

Card 2	1	2	3	4	5	6	7	8
Variable	C3	STF	RHOF	C1	C2	LCIDF	LCIDD	S0
Type	F	F	F	F	F	F	F	F

VARIABLE	DESCRIPTION
-----------------	--------------------

C3	Coefficient for fluid inertia term
STF	k , stiffness coefficient if piston bottoms out
RHOF	ρ_{fluid} , fluid density
C1	C_1 , coefficient for linear velocity term
C2	C_2 , coefficient for quadratic velocity term
LCIDF	Load curve number ID defining force as a function of piston displacement, s , that is, term $f(s + s_0)$. Compressive behavior is defined in the positive quadrant of the force displacement curve. Displacements falling outside of the defined force displacement curve are extrapolated. Care must be taken to ensure that extrapolated values are reasonable.
LCIDD	Load curve number ID defining damping coefficient as a function of piston displacement, s , that is, $g(s + s_0)$. Displacements falling outside the defined curve are extrapolated. Care must be taken to ensure that extrapolated values are reasonable.
S0	Initial displacement, s_0 ; typically set to zero. A positive displacement corresponds to compressive behavior.

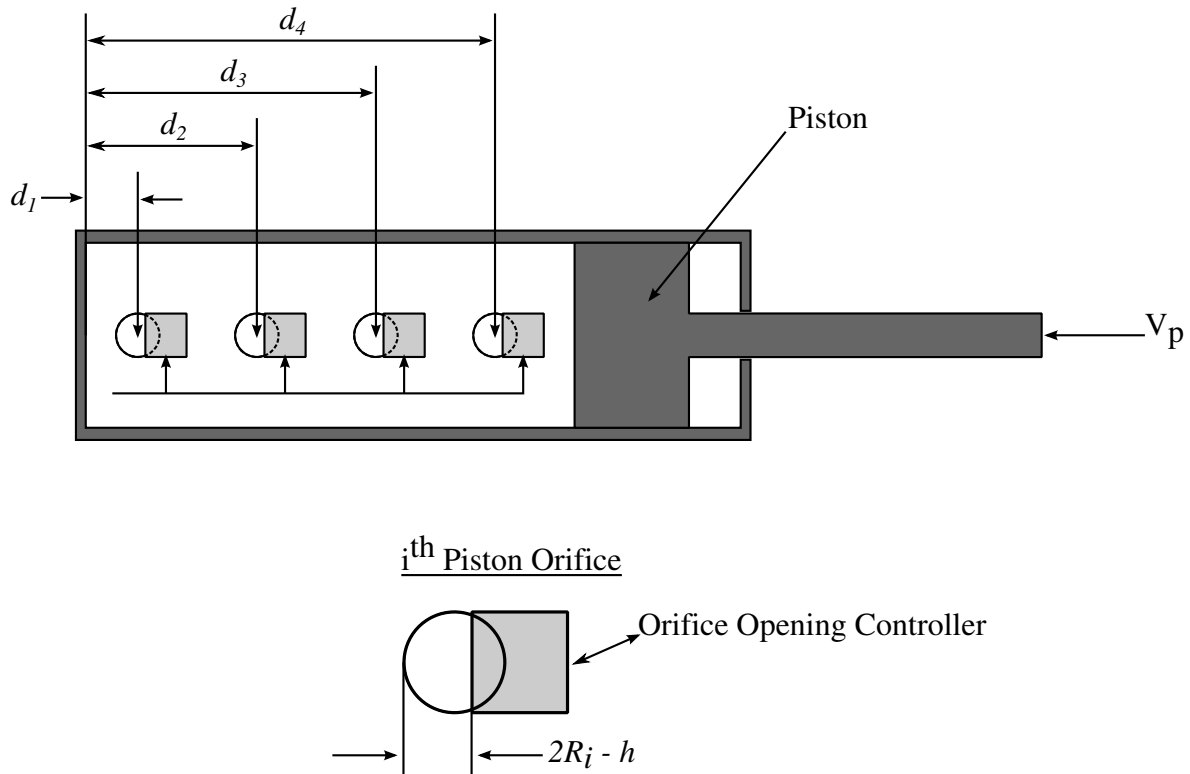

Figure M69-1. Mathematical model for the Side Impact Dummy damper.

Orifice Cards. Include one card per orifice. Read in up to 15 orifice locations. The next keyword (“*”) card terminates this input. On the first card below the optional input parameters SF and DF may be specified.

Cards 3	1	2	3	4	5	6	7	8
Variable	ORFLOC	ORFRAD	SF	DC				
Type	F	F	F	F				

VARIABLE

DESCRIPTION

ORFLOC

d_i , orifice location of i^{th} orifice relative to the fixed end

ORFRAD

r_i , orifice radius of i^{th} orifice

EQ.0.0: R on Card 1 is used.

SF

Scale factor on calculated force. The default is set to 1.0.

DC

c , linear viscous damping coefficient used after damper bottoms out either in tension or compression

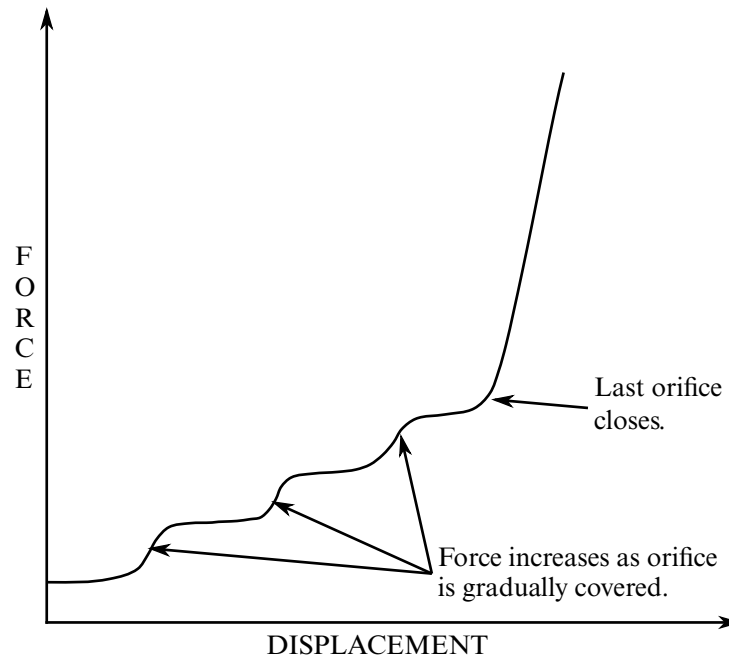

Figure M69-2. Force as a function of displacement as orifices are covered at a constant relative velocity. Only the linear velocity term is active.

Remarks:

As the damper moves, the fluid flows through the open orifices to provide the necessary damping resistance. While moving as shown in [Figure M69-1](#), the piston gradually blocks off and effectively closes the orifices. The number of orifices and the size of their opening control the damper resistance and performance. The damping force is computed from,

$$F = SF \times \left\{ KA_p V_p \left\{ \frac{C_1}{A_0^t} + C_2 |V_p| \rho_{\text{fluid}} \left[\left(\frac{A_p}{CA_0^t} \right)^2 - 1 \right] \right\} - f(s + s_0) + V_p g(s + s_0) \right\} ,$$

where K is a user defined constant or a tabulated function of the absolute value of the relative velocity, V_p is the piston velocity, C is the discharge coefficient, A_p is the piston area, A_0^t is the total open areas of orifices at time t , ρ_{fluid} is the fluid density, C_1 is the coefficient for the linear term, and C_2 is the coefficient for the quadratic term.

In the implementation, the orifices are assumed to be circular with partial covering by the orifice controller. As the piston closes, the closure of the orifice is gradual. This gradual closure is properly taken into account to insure a smooth response. If the piston stroke is exceeded, the stiffness value, k , limits further movement, meaning if the damper bottoms out in tension or compression the damper forces are calculated by replacing the damper by a bottoming out spring and damper, k and c , respectively. The piston stroke must exceed the initial length of the beam element. The time step calculation is based in part

on the stiffness value of the bottoming out spring. A typical force as a function of displacement curve at constant relative velocity is shown in [Figure M69-2](#).

The factor, SF, which scales the force defaults to 1.0 and is analogous to the adjusting ring on the damper.

***MAT_HYDRAULIC_GAS_DAMPER_DISCRETE_BEAM**

This is Material Type 70. This special purpose element represents a combined hydraulic and gas-filled damper which has a variable orifice coefficient. A schematic of the damper is shown in [Figure M70-1](#). Dampers of this type are sometimes used on buffers at the end of railroad tracks and as aircraft undercarriage shock absorbers. This material can be used only as a discrete beam element. See also the remarks below.

Card 1	1	2	3	4	5	6	7	8
Variable	MID	RO	CO	N	P0	PA	AP	KH
Type	A	F	F	F	F	F	F	F

Card 2	1	2	3	4	5	6	7	8
Variable	LCID	FR	SCLF	CLEAR				
Type	F	F	F	F				

VARIABLE**DESCRIPTION**

MID	Material identification. A unique number or label not must be specified (see *PART).
RO	Mass density, see also volume in *SECTION_BEAM definition.
CO	Length of gas column, C_0
N	Adiabatic constant, n
P0	Initial gas pressure, P_0
PA	Atmospheric pressure, P_a
AP	Piston cross sectional area, A_p
KH	Hydraulic constant, K
LCID	Load curve ID (see *DEFINE_CURVE) defining the orifice area, a_0 , as a function of element deflection S

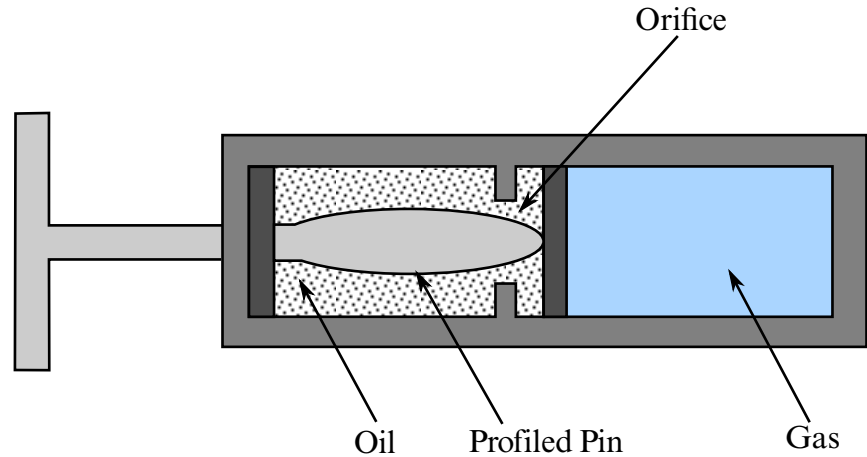

Figure M70-1. Schematic of Hydraulic/Gas damper.

VARIABLE	DESCRIPTION
FR	Return factor on orifice force. This acts as a factor on the hydraulic force only and is applied when unloading. It is intended to represent a valve that opens when the piston unloads to relieve hydraulic pressure. Set it to 1.0 for no such relief.
SCLF	Scale factor on force (default = 1.0).
CLEAR	Clearance. If nonzero, no tensile force develops for positive displacements and negative forces develop only after the clearance is closed.

Remarks:

As the damper is compressed two actions contribute to the force which develops. First, the gas is adiabatically compressed into a smaller volume. Secondly, oil is forced through an orifice. A profiled pin may occupy some of the cross-sectional area of the orifice; thus, the orifice area available for the oil varies with the stroke. The force is assumed proportional to the square of the velocity and inversely proportional to the available area.

The equation for this element is:

$$F = \text{SCLF} \times \left\{ K_h \left(\frac{V}{a_0} \right)^2 + \left[P_0 \left(\frac{C_0}{C_0 + S} \right)^n - P_a \right] A_p \right\}$$

where S is the element deflection (positive in tension) and V is the relative velocity across the element.

***MAT_CABLE_DISCRETE_BEAM**

This is Material Type 71. This model permits elastic cables to be realistically modeled; thus, no force will develop in compression.

Card 1	1	2	3	4	5	6	7	8
Variable	MID	RO	E	LCID	F0	TMAXF0	TRAMP	IREAD
Type	A	F	F	F	F	F	F	I
Default	none	none	none	none	0	0	0	0

Additional card for IREAD > 1.

Card 2	1	2	3	4	5	6	7	8
Variable	OUTPUT	TSTART	FRACLO	MXEPS	MXFRC			
Type	I	F	F	F	F			
Default	0	0	0	1.0E+20	1.0E+20			

VARIABLE**DESCRIPTION**

MID	Material identification. A unique number or label must be specified (see *PART).
RO	Mass density, see also volume in *SECTION_BEAM definition.
E	GT.0.0: Young's modulus LT.0.0: Stiffness
LCID	Load curve ID, see *DEFINE_CURVE, defining the stress versus engineering strain. (Optional).
F0	Initial tensile force. If F0 is defined, an offset is not needed for an initial tensile force.
TMAXF0	Time for which pre-tension force will be held

VARIABLE	DESCRIPTION
TRAMP	Ramp-up time for pre-tension force
IREAD	Set to 1 to read second line of input
OUTPUT	Flag = 1 to output axial strain (see note below concerning OUTPUT)
TSTART	Time at which the ramp-up of pre-tension begins
FRACL0	Fraction of initial length that should be reached over time period of TRAMP. Corresponding tensile force builds up as necessary to reach cable length = FRACL0 × L0 at time t = TRAMP.
MXEPS	Maximum strain at failure
MXFRC	Maximum force at failure

Remarks:

The force, F , generated by the cable is nonzero if and only if the cable is tension. The force is given by:

$$F = \max(F_0 + K\Delta L, 0.)$$

where ΔL is the change in length

$$\Delta L = \text{current length} - (\text{initial length} - \text{offset})$$

and the stiffness ($E > 0.0$ only) is defined as:

$$K = \frac{E \times \text{area}}{(\text{initial length} - \text{offset})}$$

Note that a constant force element can be obtained by setting:

$$F_0 > 0 \text{ and } K = 0$$

although the application of such an element is unknown.

The area and offset are defined on either the cross section or element cards. For a slack cable the offset should be input as a negative length. For an initial tensile force the offset should be positive.

If a load curve is specified the Young's modulus will be ignored and the load curve will be used instead. The points on the load curve are defined as engineering stress versus engineering strain, i.e., the change in length over the initial length. The unloading behavior follows the loading.

By default, cable pretension is applied only at the start of the analysis. If the cable is attached to flexible structure, deformation of the structure will result in relaxation of the cables, which will therefore lose some or all of the intended preload.

This can be overcome by using TMAXF0. In this case, it is expected that the structure will deform under the loading from the cables and that this deformation will take time to occur during the analysis. The unstressed length of the cable will be continuously adjusted until time TMAXF0 such that the force is maintained at the user-defined pre-tension force – this is analogous to operation of the pre-tensioning screws in real cables. After time TMAXF0, the unstressed length is fixed and the force in the cable is determined in the normal way using the stiffness and change of length.

Sudden application of the cable forces at time zero may result in an excessively dynamic response during pre-tensioning. A ramp-up time TRAMP may optionally be defined. The cable force ramps up from zero at time TSTART to the full pre-tension F0 at time TSTART + TRAMP. TMAXF0, if set less than TSTART + TRAMP by the user, will be internally reset to TSTART + TRAMP.

If the model does not use dynamic relaxation, it is recommended that damping be applied during pre-tensioning so that the structure reaches a steady state by time TMAXF0.

If the model uses dynamic relaxation, TSTART, TRAMP, and TMAXF0 apply only during dynamic relaxation. The cable preload at the end of dynamic relaxation carries over to the start of the subsequent transient analysis.

The cable mass will be calculated from length \times area \times density if VOL is set to zero on *SECTION_BEAM. Otherwise, VOL \times density will be used.

If OUTPUT is set to 1, one additional history variable representing axial strain is output to d3plot for the cable elements. This axial strain can be plotted by LS-PrePost by selecting the beam component labeled as “axial stress”. Though the label says “axial stress”, it is actually axial strain.

If the stress-strain load curve option, LCID, is combined with preload, two types of behavior are available:

1. If the preload is applied using the TMAXF0/TRAMP method, the initial strain is calculated from the stress-strain curve to achieve the desired preload.
2. If TMAXF0/TRAMP are not used, the preload force is taken as additional to the force calculated from the stress/strain curve. Thus, the total stress in the cable will be higher than indicated by the stress/strain curve.

*MAT_CONCRETE_DAMAGE

This is Material Type 72. This model has been used to analyze buried steel reinforced concrete structures subjected to impulsive loadings. A newer version of this model is available as *MAT_CONCRETE_DAMAGE_REL3.

Card Summary:

Card 1. This card is required.

MID	RO	PR					
-----	----	----	--	--	--	--	--

Card 2. This card is required.

SIGF	A0	A1	A2				
------	----	----	----	--	--	--	--

Card 3. This card is required.

A0Y	A1Y	A2Y	A1F	A2F	B1	B2	B3
-----	-----	-----	-----	-----	----	----	----

Card 4. This card is required.

PER	ER	PRR	SIGY	ETAN	LCP	LCR	
-----	----	-----	------	------	-----	-----	--

Card 5. This card is required.

λ_1	λ_2	λ_3	λ_4	λ_5	λ_6	λ_7	λ_8
-------------	-------------	-------------	-------------	-------------	-------------	-------------	-------------

Card 6. This card is required.

λ_9	λ_{10}	λ_{11}	λ_{12}	λ_{13}			
-------------	----------------	----------------	----------------	----------------	--	--	--

Card 7. This card is required.

η_1	η_2	η_3	η_4	η_5	η_6	η_7	η_8
----------	----------	----------	----------	----------	----------	----------	----------

Card 8. This card is required.

η_9	η_{10}	η_{11}	η_{12}	η_{13}			
----------	-------------	-------------	-------------	-------------	--	--	--

Data Card Definitions:

Card 1	1	2	3	4	5	6	7	8
Variable	MID	RO	PR					
Type	A	F	F					
Default	none	none	none					

VARIABLE**DESCRIPTION**

MID	Material identification. A unique number or label must be specified (see *PART).
RO	Mass density
PR	Poisson's ratio

Card 2	1	2	3	4	5	6	7	8
Variable	SIGF	A0	A1	A2				
Type	F	F	F	F				
Default	0.0	0.0	0.0	0.0				

VARIABLE**DESCRIPTION**

SIGF	Maximum principal stress for failure
A0	Cohesion
A1	Pressure hardening coefficient
A2	Pressure hardening coefficient

Card 3	1	2	3	4	5	6	7	8
Variable	A0Y	A1Y	A2Y	A1F	A2F	B1	B2	B3
Type	F	F	F	F	F	F	F	F
Default	0.0	0.0	0.0	0.0	0.0	0.0	0.0	0.0

VARIABLE

DESCRIPTION

A0Y	Cohesion for yield
A1Y	Pressure hardening coefficient for yield limit
A2Y	Pressure hardening coefficient for yield limit
A1F	Pressure hardening coefficient for failed material
A2F	Pressure hardening coefficient for failed material
B1	Damage scaling factor
B2	Damage scaling factor for uniaxial tensile path
B3	Damage scaling factor for triaxial tensile path

Card 4	1	2	3	4	5	6	7	8
Variable	PER	ER	PRR	SIGY	ETAN	LCP	LCR	
Type	F	F	F	F	F	F	F	
Default	0.0	0.0	0.0	none	0.0	none	none	

VARIABLE

DESCRIPTION

PER	Percent reinforcement
ER	Elastic modulus for reinforcement
PRR	Poisson's ratio for reinforcement

VARIABLE	DESCRIPTION
SIGY	Initial yield stress
ETAN	Tangent modulus/plastic hardening modulus
LCP	Load curve ID giving rate sensitivity for principal material; see *DEFINE_CURVE.
LCR	Load curve ID giving rate sensitivity for reinforcement; see *DEFINE_CURVE.

Card 5	1	2	3	4	5	6	7	8
Variable	λ_1	λ_2	λ_3	λ_4	λ_5	λ_6	λ_7	λ_8
Type	F	F	F	F	F	F	F	F
Default	none	none	none	none	none	none	none	none

Card 6	1	2	3	4	5	6	7	8
Variable	λ_9	λ_{10}	λ_{11}	λ_{12}	λ_{13}			
Type	F	F	F	F	F			
Default	none	none	none	none	none			

VARIABLE	DESCRIPTION
$\lambda_1 - \lambda_{13}$	Tabulated damage function

Card 7	1	2	3	4	5	6	7	8
Variable	η_1	η_2	η_3	η_4	η_5	η_6	η_7	η_8
Type	F	F	F	F	F	F	F	F
Default	none	none	none	none	none	none	none	none

Card 8	1	2	3	4	5	6	7	8
Variable	η_9	η_{10}	η_{11}	η_{12}	η_{13}			
Type	F	F	F	F	F			
Default	none	none	none	none	none			

VARIABLE**DESCRIPTION** $\eta_1 - \eta_{13}$

Tabulated scale factor.

Remarks:

1. **Cohesion.** Cohesion for failed material $a_{0f} = 0$.
2. **B3.** B3 must be positive or zero.
3. **Damage Function.** $\lambda_n \leq \lambda_{n+1}$. The first point must be zero.

***MAT_CONCRETE_DAMAGE_REL3**

This is Material Type 72R3. The Karagozian & Case (K&C) Concrete Model - Release III is a three-invariant model, uses three shear failure surfaces, includes damage and strain-rate effects, and has origins based on the Pseudo-TENSOR Model (Material Type 16). The most significant user improvement provided by Release III is a model parameter generation capability, based solely on the unconfined compression strength of the concrete. The implementation of Release III significantly changed the user input, thus previous input files using Material Type 72 prior to LS-DYNA Version 971, are not compatible with the present input format.

An open source reference, that precedes the parameter generation capability, is provided in Malvar et al. [1997]. A workshop proceedings reference, Malvar et al. [1996], is useful, but may be difficult to obtain. More recent, but *limited distribution* reference materials, such as Malvar et al. [2000], may be obtained by contacting Karagozian & Case.

Seven card images are required to define the *complete* set of model parameters for the K&C Concrete Model. An Equation-of-State is also required for the pressure-volume strain response. Brief descriptions of all the input parameters are provided below, however it is expected that this model will be used primarily with the option to automatically generate the model parameters based on the unconfined compression strength of the concrete. These generated material parameters, along with the generated parameters for *EOS_TABULATED_COMPACTION, are written to the d3hsp file.

Card 1	1	2	3	4	5	6	7	8
Variable	MID	R0	PR					
Type	A	F	F					
Default	none	none	none					

Card 2	1	2	3	4	5	6	7	8
Variable	FT	A0	A1	A2	B1	OMEGA	A1F	
Type	F	F	F	F	F	F	F	
Default	none	0.0	0.0	0.0	0.0	none	0.0	

Card 3	1	2	3	4	5	6	7	8
Variable	Sλ	NOUT	EDROP	RSIZE	UCF	LCRATE	LOCWID	NPTS
Type	F	F	F	F	F	I	F	F
Default	none	none	none	none	none	none	none	none

Card 4	1	2	3	4	5	6	7	8
Variable	λ01	λ02	λ03	λ04	λ05	λ06	λ07	λ08
Type	F	F	F	F	F	F	F	F
Default	none	none	none	none	none	none	none	none

Card 5	1	2	3	4	5	6	7	8
Variable	λ09	λ10	λ11	λ12	λ13	B3	A0Y	A1Y
Type	F	F	F	F	F	F	F	F
Default	none	none	none	none	none	none	0.0	0.0

Card 6	1	2	3	4	5	6	7	8
Variable	η01	η02	η03	η04	η05	η06	η07	η08
Type	F	F	F	F	F	F	F	F
Default	none	none	none	none	none	none	none	none

Card 7	1	2	3	4	5	6	7	8
Variable	η_{09}	η_{10}	η_{11}	η_{12}	η_{13}	B2	A2F	A2Y
Type	F	F	F	F	F	F	F	F
Default	none	none	none	none	none	0.0	0.0	0.0

VARIABLE**DESCRIPTION**

MID	Material identification. A unique number or label must be specified (see *PART).
RO	Mass density
PR	Poisson's ratio, ν
FT	Uniaxial tensile strength, f_t
A0	Maximum shear failure surface parameter, a_0 , or $-f'_c$ for parameter generation (recommended)
A1	Maximum shear failure surface parameter, a_1
A2	Maximum shear failure surface parameter, a_2
B1	Compressive damage scaling parameter, b_1
OMEGA	Fractional dilatancy, ω
A1F	Residual failure surface coefficient, a_{1f}
$S\lambda$	λ stretch factor, s
NOUT	Output selector for effective plastic strain (see table)
EDROP	Post peak dilatancy decay, N^α
RSIZE	Unit conversion factor for length (inches/user-unit). For example, set to 39.37 if user length unit in meters.
UCF	Unit conversion factor for stress (psi/user-unit). For instance set to 145 if f'_c in MPa.

VARIABLE	DESCRIPTION
LCRATE	Define (load) curve number for strain-rate effects; effective strain rate on abscissa (negative = tension) and strength enhancement on ordinate. If LCRATE is set to -1, strain rate effects are automatically included, based on equations provided in Wu, Crawford, Lan, and Magallanes [2014]. LCRATE = -1 is applicable to models which use time units of seconds, for other time units, the strain-rate effects should be input by means of a curve.
LOCWID	Three times the maximum aggregate diameter (input in user length units).
NPTS	Number of points in λ versus η damage relation; must be 13 points.
$\lambda 01$	1 st value of damage function, (a.k.a., 1 st value of “modified” effective plastic strain; see references for details).
$\lambda 02$	2 nd value of damage function,
$\lambda 03$	3 rd value of damage function,
$\lambda 04$	4 th value of damage function,
$\lambda 05$	5 th value of damage function,
$\lambda 06$	6 th value of damage function,
$\lambda 07$	7 th value of damage function,
$\lambda 08$	8 th value of damage function,
$\lambda 09$	9 th value of damage function,
$\lambda 10$	10 th value of damage function,
$\lambda 11$	11 th value of damage function,
$\lambda 12$	12 th value of damage function,
$\lambda 13$	13 th value of damage function.
B3	Damage scaling coefficient for triaxial tension, b_3 .
A0Y	Initial yield surface cohesion, a_{0y} .
A1Y	Initial yield surface coefficient, a_{1y} .
$\eta 01$	1 st value of scale factor,

VARIABLE	DESCRIPTION
η_{02}	2 nd value of scale factor,
η_{03}	3 rd value of scale factor,
η_{04}	4 th value of scale factor,
η_{05}	5 th value of scale factor,
η_{06}	6 th value of scale factor,
η_{07}	7 th value of scale factor,
η_{08}	8 th value of scale factor,
η_{09}	9 th value of scale factor,
η_{10}	10 th value of scale factor,
η_{11}	11 th value of scale factor,
η_{12}	12 th value of scale factor,
η_{13}	13 th value of scale factor.
B2	Tensile damage scaling exponent, b_2 .
A2F	Residual failure surface coefficient, a_{2f} .
A2Y	Initial yield surface coefficient, a_{2y} .

λ , sometimes referred to as “modified” effective plastic strain, is computed internally as a function of effective plastic strain, strain rate enhancement factor, and pressure. η is a function of λ as specified by the η as a function of λ curve. The η value, which is always between 0 and 1, is used to interpolate between the yield failure surface and the maximum failure surface or between the maximum failure surface and the residual failure surface, depending on whether λ is to the left or right of the first peak in the η as a function of λ curve. The “scaled damage measure” ranges from 0 to 1 as the material transitions from the yield failure surface to the maximum failure surface, and thereafter ranges from 1 to 2 as the material ranges from the maximum failure surface to the residual failure surface. See the references for details.

Output of Selected Variables:

The quantity labeled as “plastic strain” by LS-PrePost is actually the quantity described in [Table M72-1](#), in accordance with the input value of NOUT (see Card 3 above).

NOU	Function	Description
1		Current shear failure surface radius
2	$\delta = 2\lambda/(\lambda + \lambda_m)$	Scaled damage measure
3	$\dot{\sigma}_{ij}\dot{\epsilon}_{ij}$	Strain energy (rate)
4	$\dot{\sigma}_{ij}\dot{\epsilon}_{ij}^p$	Plastic strain energy (rate)

Table M72-1. Description of quantity labeled “plastic strain” by LS-PrePost.

An additional six extra history variables as shown in [Table M72-2](#) may be written by setting NEIPH = 6 on the keyword *DATABASE_EXTENT_BINARY. The extra history variables are labeled as "history var#1" through "history var#6" in LS-PrePost.

Label	Description
history var#1	Internal energy
history var#2	Pressure from bulk viscosity
history var#3	Volume in previous time step
history var#4	Plastic volumetric strain
history var#5	Slope of damage evolution (η vs. λ) curve
history var#6	“Modified” effective plastic strain (λ)

Table M72-2. Extra History Variables for *MAT_072R3

Sample Input for Concrete:

As an example of the K&C Concrete Model material parameter generation, the following sample input for a 45.4 MPa (6,580 psi) unconfined compression strength concrete is provided. The basic units for the provided parameters are length in millimeters (mm), time in milliseconds (msec), and mass in grams (g). This base unit set yields units of force in Newtons (N) and pressure in Mega-Pascals (MPa).

Card 1	1	2	3	4	5	6	7	8
Variable	MID	RO	PR					
Value	72	2.3E-3						

Card 2	1	2	3	4	5	6	7	8
Variable	FT	A0	A1	A2	B1	OMEGA	A1F	
Value		-45.4						

Card 3	1	2	3	4	5	6	7	8
Variable	Sλ	NOUT	EDROP	RSIZE	UCF	LCRATE	LOCWID	NPTS
Value				3.94E-2	145.0	723		

Card 4	1	2	3	4	5	6	7	8
Variable	λ01	λ02	λ03	λ04	λ05	λ06	λ07	λ08
Value								

Card 5	1	2	3	4	5	6	7	8
Variable	λ09	λ10	λ11	λ12	λ13	B3	A0Y	A1Y
Value								

Card 6	1	2	3	4	5	6	7	8
Variable	η01	η02	η03	η04	η05	η06	η07	η08
Value								

Card 7	1	2	3	4	5	6	7	8
Variable	η_{09}	η_{10}	η_{11}	η_{12}	η_{13}	B2	A2F	A2Y
Value								

Shear strength enhancement factor as a function of effective strain rate is given by a curve (*DEFINE_CURVE) with LCID 723. The sample input values, see Malvar & Ross [1998], are given in [Table M72-3](#).

Strain-Rate (1/ms)	Enhancement
-3.0E+01	9.70
-3.0E-01	9.70
-1.0E-01	6.72
-3.0E-02	4.50
-1.0E-02	3.12
-3.0E-03	2.09
-1.0E-03	1.45
-1.0E-04	1.36
-1.0E-05	1.28
-1.0E-06	1.20
-1.0E-07	1.13
-1.0E-08	1.06
0.0E+00	1.00
3.0E-08	1.00
1.0E-07	1.03
1.0E-06	1.08
1.0E-05	1.14
1.0E-04	1.20
1.0E-03	1.26
3.0E-03	1.29
1.0E-02	1.33

Strain-Rate (1/ms)	Enhancement
3.0E-02	1.36
1.0E-01	2.04
3.0E-01	2.94
3.0E+01	2.94

Table M72-3. Enhancement as a function of effective strain rate for 45.4 MPa concrete (sample). When defining curve LCRATE, input negative (tensile) values of effective strain rate first. The enhancement should be positive and should be 1.0 at a strain rate of zero.

*MAT_LOW_DENSITY_VISCOUS_FOAM

This is Material Type 73. This material model is for Modeling Low Density Urethane Foam with high compressibility and rate sensitivity which can be characterized by a relaxation curve. Its main applications are for seat cushions, padding on the Side Impact Dummies (SID), bumpers, and interior foams. Optionally, a tension cut-off failure can be defined. See the remarks below and the description of material 57.

Card Summary:

Card 1. This card is required.

MID	RO	E	LCID	TC	HU	BETA	DAMP
-----	----	---	------	----	----	------	------

Card 2. This card is required.

SHAPE	FAIL	BVFLAG	KCON	LCID2	BSTART	TRAMP	NV
-------	------	--------	------	-------	--------	-------	----

Card 3a. This card is included if and only if LCID2 = 0. Include up to 6 of this card. The next keyword ("*") card terminates this input.

G_i	BETA $_i$	REF					
-------	-----------	-----	--	--	--	--	--

Card 3b. This card is included if and only if LCID2 = -1.

LCID3	LCID4	SCALEW	SCALEA				
-------	-------	--------	--------	--	--	--	--

Data Card Definitions:

Card 1	1	2	3	4	5	6	7	8
Variable	MID	RO	E	LCID	TC	HU	BETA	DAMP
Type	A	F	F	I	F	F	F	F
Default	none	none	none	none	10 ²⁰	1.	none	0.05

VARIABLE

DESCRIPTION

MID	Material identification. A unique number or label must be specified (see *PART).
RO	Mass density

VARIABLE	DESCRIPTION
E	Young's modulus used in tension. For implicit problems E is set to the initial slope of load curve LCID.
LCID	Load curve ID (see *DEFINE_CURVE) for nominal stress as a function of strain
TC	Tension cut-off stress
HU	Hysteretic unloading factor between 0 and 1 (default = 1, that is, no energy dissipation); see Figure M57-1 and Remark 3 .
BETA	β , decay constant to model creep in unloading (see Remark 3) EQ.0.0: no relaxation
DAMP	Viscous coefficient (.05 < recommended value <.50) to model damping effects. LT.0.0: DAMP is the load curve ID which defines the damping constant as a function of the maximum strain in compression defined as: $\varepsilon_{\max} = \max(1 - \lambda_1, 1 - \lambda_2, 1 - \lambda_3) .$ In tension, the damping constant is set to the value corresponding to the strain at 0. The abscissa should be defined from 0 to 1.

Card 2	1	2	3	4	5	6	7	8
Variable	SHAPE	FAIL	BVFLAG	KCON	LCID2	BSTART	TRAMP	NV
Type	F	F	F	F	I	F	F	I
Default	1.0	0.0	0.0	0.0	0	0.0	0.0	6

VARIABLE	DESCRIPTION
SHAPE	Shape factor for unloading which is active for nonzero values of HU. SHAPE less than one reduces the energy dissipation and greater than one increases dissipation; see Figure M57-1 .
FAIL	Failure option after cutoff stress is reached:

VARIABLE	DESCRIPTION
	EQ.0.0: tensile stress remains at cut-off value. EQ.1.0: tensile stress is reset to zero.
BVFLAG	Bulk viscosity activation flag (see remarks below): EQ.0.0: no bulk viscosity (recommended) EQ.1.0: bulk viscosity active
KCON	Stiffness coefficient for contact interface stiffness. If undefined, the maximum slope in the stress as a function of strain curve is used. When the maximum slope is taken for the contact, the time step size for this material is reduced for stability. In some cases, Δt may be significantly smaller, so defining a reasonable stiffness is recommended.
LCID2	Load curve ID of relaxation curve. If $LCID2 > 0$, constants G_i and β_i are determined using a least squares fit. An example is shown in Figure M76-1 . This model ignores the constant stress.
BSTART	Fit parameter. In the fit, β_1 is set to zero, β_2 is set to BSTART, β_3 is 10 times β_2 , β_4 is 10 times greater than β_3 , and so on. If zero, BSTART = .01.
TRAMP	Optional ramp time for loading
NV	Number of terms in fit. Currently, the maximum number is 6. Since each term used adds significantly to the cost, 2 or 3 terms is recommended. Caution should be exercised when taking the results from the fit. Preferably, all generated coefficients should be positive because negative values may lead to unstable results. Once a satisfactory fit has been achieved, we recommend using the output coefficients in future runs.

Relaxation Constant Cards. If $LCID2 = 0$, then include this card. Up to 6 cards may be input. The next keyword ("*") card terminates this input.

Card 3a	1	2	3	4	5	6	7	8
Variable	G_i	BETA i	REF					
Type	F	F	F					

VARIABLE	DESCRIPTION
G_i	Optional shear relaxation modulus for the i^{th} term
BETA i	Optional decay constant if i^{th} term
REF	Use reference geometry to initialize the stress tensor. The reference geometry is defined by the keyword: *INITIAL_FOAM_REFERENCE_GEOMETRY. EQ.0.0: off EQ.1.0: on

Frequency Dependence Card. If LCID2 = -1 then include this card.

Card 3b	1	2	3	4	5	6	7	8
Variable	LCID3	LCID4	SCALEW	SCALEA				
Type	I	I	I	I				

VARIABLE	DESCRIPTION
LCID3	Load curve ID giving the magnitude of the shear modulus as a function of the frequency. LCID3 must use the same frequencies as LCID4.
LCID4	Load curve ID giving the phase angle of the shear modulus as a function of the frequency. LCID4 must use the same frequencies as LCID3.
SCALEW	Flag for the form of the frequency data: EQ.0: frequency is in cycles per unit time. EQ.1: circular frequency
SCALEA	Flag for the units of the phase angle: EQ.0: degrees EQ.1: radians

Remarks:

1. **Material Formulation.** This viscoelastic foam material formulation models highly compressible viscous foams. The hyperelastic formulation of this model follows that of Material 57.
2. **Rate Effects.** Rate effects are accounted for through linear viscoelasticity by a convolution integral of the form

$$\sigma_{ij}^r = \int_0^t g_{ijkl}(t - \tau) \frac{\partial \varepsilon_{kl}}{\partial \tau} d\tau ,$$

where $g_{ijkl}(t - \tau)$ is the relaxation function. The stress tensor, σ_{ij}^r , augments the stresses determined from the foam, σ_{ij}^f ; consequently, the final stress, σ_{ij} , is taken as the summation of the two contributions:

$$\sigma_{ij} = \sigma_{ij}^f + \sigma_{ij}^r .$$

Since we wish to include only simple rate effects, the relaxation function is represented by up to six terms of the Prony series:

$$g(t) = \alpha_0 + \sum_{m=1}^N \alpha_m e^{-\beta_m t} .$$

This model is effectively a Maxwell fluid which consists of a dampers and springs in series. The formulation is performed in the local system of principal stretches where only the principal values of stress are computed and triaxial coupling is avoided. Consequently, the one-dimensional nature of this foam material is unaffected by this addition of rate effects. The addition of rate effects necessitates 42 additional history variables per integration point. The cost and memory overhead of this model comes primarily from the need to “remember” the local system of principal stretches and the evaluation of the viscous stress components.

Frequency data can be fit to the Prony series. Using Fourier transforms the relationship between the relaxation function and the frequency dependent data is

$$G_s(\omega) = \alpha_0 + \sum_{m=1}^N \frac{\alpha_m (\omega/\beta_m)^2}{1 + (\omega/\beta_m)^2}$$

$$G_l(\omega) = \sum_{m=1}^N \frac{\alpha_m \omega/\beta_m}{1 + \omega/\beta_m}$$

where the storage modulus and loss modulus are defined in terms of the frequency dependent magnitude G and phase angle ϕ given by load curves LCID3 and LCID4 respectively,

$$G_s(\omega) = G(\omega) \cos[\phi(\omega)]$$

$$G_l(\omega) = G(\omega) \sin[\phi(\omega)]$$

3. **Hysteretic Unloading.** When hysteretic unloading is used, the reloading will follow the unloading curve if the decay constant, β , is set to zero. If β is nonzero, the decay to the original loading curve is governed by the expression:

$$1 - e^{-\beta t}$$

The bulk viscosity, which generates a rate dependent pressure, may cause an unexpected volumetric response and, consequently, it is optional with this model.

The hysteretic unloading factor results in the unloading curve to lie beneath the loading curve as shown in [Figure M57-1](#). This unloading provides energy dissipation which is reasonable in certain kinds of foam.

*MAT_ELASTIC_SPRING_DISCRETE_BEAM

This is Material Type 74. This model permits elastic springs with damping to be combined and represented with a discrete beam element type 6. Linear stiffness and damping coefficients can be defined, and, for nonlinear behavior, a force as a function of deflection and force as a function of rate curves can be used. Displacement based failure and an initial force are optional.

Card 1	1	2	3	4	5	6	7	8
Variable	MID	RO	K	F0	D	CDF	TDF	
Type	A	F	F	F	F	F	F	

Card 2	1	2	3	4	5	6	7	8
Variable	FLCID	HLCID	C1	C2	DLE	GLCID		
Type	F	F	F	F	F	I		

VARIABLE

DESCRIPTION

- MID Material identification. A unique number or label must be specified (see *PART).
- RO Mass density; see also volume in *SECTION_BEAM definition.
- K Stiffness coefficient.
- F0 Optional initial force. This option is inactive if this material is referenced in a part referenced by material type *MAT_ELASTIC_6DOF_SPRING.
- D Viscous damping coefficient.
- CDF Compressive displacement at failure. Input as a positive number. After failure, no forces are carried. This option does not apply to zero length springs.
EQ.0.0: inactive.
- TDF Tensile displacement at failure. After failure, no forces are carried.

VARIABLE	DESCRIPTION
FLCID	Load curve ID (see *DEFINE_CURVE) defining force as a function of deflection for nonlinear behavior.
HLCID	Load curve ID (see *DEFINE_CURVE) defining force as a function of relative velocity for nonlinear behavior (optional). If the origin of the curve is at (0,0), the force magnitude is identical for a given magnitude of the relative velocity, that is, only the sign changes.
C1	Damping coefficient for nonlinear behavior (optional).
C2	Damping coefficient for nonlinear behavior (optional).
DLE	Factor to scale time units. The default is unity.
GLCID	Optional load curve ID (see *DEFINE_CURVE) defining a scale factor as a function of deflection for load curve ID, HLCID. If zero, a scale factor of unity is assumed.

Remarks:

If the linear spring stiffness is used, the force, F , is given by:

$$F = F_0 + K\Delta L + D\Delta\dot{L} .$$

But if the load curve ID is specified, the force is then given by:

$$F = F_0 + Kf(\Delta L) \left\{ 1 + C1 \times \Delta\dot{L} + C2 \times \text{sgn}(\Delta\dot{L}) \ln \left[\max \left(1, \frac{\Delta\dot{L}}{DLE} \right) \right] \right\} + D\Delta\dot{L} + g(\Delta L)h(\Delta\dot{L}) .$$

In these equations, ΔL is the change in length, that is,

$$\Delta L = \text{current length} - \text{initial length} .$$

The cross-sectional area is defined on the section card for the discrete beam elements; see *SECTION_BEAM. The square root of this area is used as the contact thickness offset if these elements are included in the contact treatment.

*MAT_BILKHU/DUBOIS_FOAM

This is Material Type 75. This model is for simulating isotropic crushable foams. Uniaxial and triaxial test data are used to describe the behavior.

Card 1	1	2	3	4	5	6	7	8
Variable	MID	RO	E	LCPY	LCUYS	VC	PC	VPC
Type	A	F	F	F	F	F	F	F

Card 2	1	2	3	4	5	6	7	8
Variable	TSC	VTSC	LCRATE	PR	KCON	ISFLG	NCYCLE	
Type	I	F	F	F	F	F	F	

VARIABLE**DESCRIPTION**

MID	Material identification. A unique number or label must be specified (see *PART).
RO	Mass density
E	Young's modulus, E
LCPY	Load curve ID giving pressure for plastic yielding as a function of volumetric strain; see Figure M75-1 .
LCUYS	Load curve ID giving uniaxial yield stress as a function of volumetric strain (see Figure M75-1). All abscissa values should be positive if only the results of a compression test are included. Optionally the results of a tensile test can be added (corresponding to negative values of the volumetric strain); in this case PC, VPC, TC and VTC will be ignored.
VC	Viscous damping coefficient ($0.05 < \text{recommended value} < 0.50$; default is 0.05)
PC	Pressure cutoff for hydrostatic tension. If zero, the default is set to one-tenth of p_0 , the yield pressure corresponding to a volumetric strain of zero. PC will be ignored if TC is nonzero.

VARIABLE	DESCRIPTION
VPC	Variable pressure cutoff for hydrostatic tension as a fraction of pressure yield value. If nonzero this will override the pressure cut-off value PC.
TC	Tension cutoff for uniaxial tensile stress. Default is zero. A non-zero value is recommended for better stability.
VTC	Variable tension cutoff for uniaxial tensile stress as a fraction of the uniaxial compressive yield strength. If nonzero; this will override the tension cutoff value TC.
LCRATE	Load curve ID giving a scale factor for the previous yield curves, dependent upon the volumetric strain rate
PR	Poisson’s ratio, which applies to both elastic and plastic deformations. It must be smaller then 0.5.
KCON	Stiffness coefficient for contact interface stiffness. If undefined one-third of Young’s modulus, E, is used. KCON is also considered in the element time step calculation; therefore, large values may reduce the element time step size.
ISFLG	Flag for tensile response (active only if negative abscissa are present in load curve LCUYS): EQ.0: load curve abscissa in tensile region correspond to volumetric strain EQ.1: load curve abscissa in tensile region correspond to effective strain (for large PR, when volumetric strain vanishes)
NCYCLE	Number of cycles to determine the average volumetric strain rate. NCYCLE is 1 by default (no smoothing) and cannot exceed 100.

Remarks:

- Volumetric Strain.** The logarithmic volumetric strain is defined in terms of the relative volume, V , as:

$$\gamma = -\ln(V)$$

If option ISFLG = 1 is used, the effective strain is defined in the usual way:

$$\epsilon_{\text{eff}} = \sqrt{\frac{2}{3} \text{tr}(\epsilon^t \epsilon)}$$

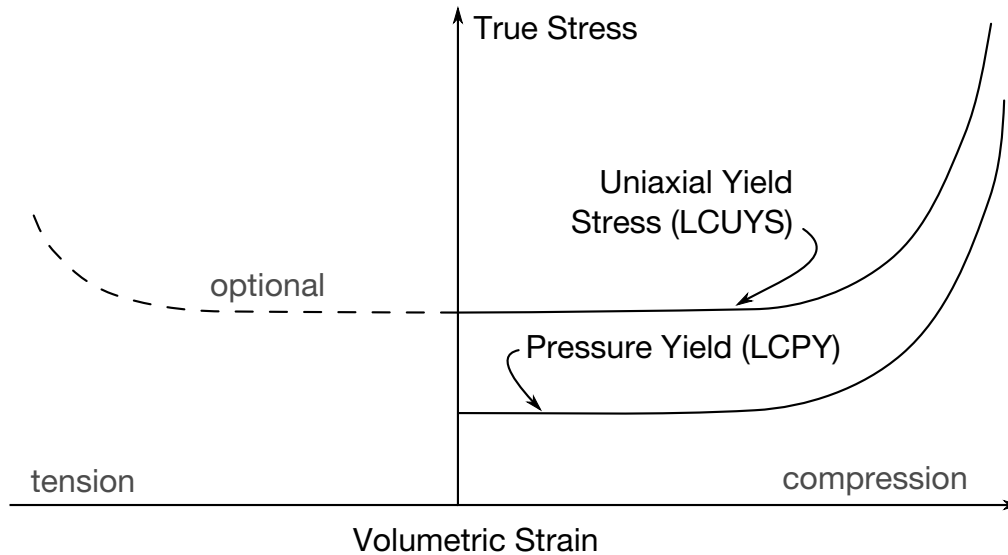

Figure M75-1. Behavior of crushable foam. Unloading is elastic.

The stress and strain pairs in load curve LCPY should be positive values starting with a volumetric strain value of zero.

2. **LCUYS.** The load curve LCUYS can optionally contain the results of the tensile test (corresponding to negative values of the volumetric strain); if it does, then the load curve information will override PC, VPC, TC and VTC. This is the recommended approach, because the necessary continuity between tensile and compressive regime becomes obvious (see [Figure M75-1](#)).
3. **Yield Surface.** The yield surface is defined as an ellipse in the equivalent pressure and von Mises stress plane. This ellipse is characterized by three points:
 - a) the hydrostatic compression limit (LCPY),
 - b) the uniaxial compression limit (LCUYS), and
 - c) either the pressure cutoff for hydrostatic stress (PC,VPC), the tension cutoff for uniaxial tension (TC,VTC), or the optional tensile part of LCUYS.
4. **High Frequency Oscillations.** To prevent high frequency oscillations in the strain rate from causing similar high frequency oscillations in the yield stress, a modified volumetric strain rate is used to obtain the scaled yield stress. The modified strain rate is obtained as follows. If NYCLE is > 1 , then the modified strain rate is obtained by a time average of the actual strain rate over NYCLE solution cycles. The averaged strain rate is stored in history variable #3.

***MAT_GENERAL_VISCOELASTIC_{OPTION}**

The available options include:

<BLANK>

MOISTURE

This is Material Type 76. This material model provides a general viscoelastic Maxwell model having up to 18 terms in the Prony series expansion and is useful for modeling dense continuum rubbers and solid explosives. Either the coefficients of the Prony series expansion or a relaxation curve may be specified to define the viscoelastic deviatoric and bulk behavior.

The material model can also be used with laminated shells. Either an elastic or viscoelastic layer can be defined with the laminated formulation. To activate laminated shells, you must set the laminated formulation flag on *CONTROL_SHELL. With the laminated option you must also define an integration rule. The addition of an elastic or viscoelastic layer was implemented by Professor Ala Tabiei, and the laminated shells feature was developed and implemented by Professor Ala Tabiei.

Card Summary:

Card 1. This card is required.

MID	RO	BULK	PCF	EF	TREF	A	B
-----	----	------	-----	----	------	---	---

Card 2. Leave blank if the Prony Series Cards (Card 4) are used below. Also, leave blank if an elastic layer is defined in a laminated shell.

LCID	NT	BSTART	TRAMP	LCIDK	NTK	BSTARTK	TRAMPK
------	----	--------	-------	-------	-----	---------	--------

Card 3. This card is included if and only if the MOISTURE keyword option is used.

MO	ALPHA	BETA	GAMMA	MST			
----	-------	------	-------	-----	--	--	--

Card 4. Up to 18 cards may be input. This input is terminated at the next keyword ("*") card.

G_i	$BETA_i$	K_i	$BETA_{AK_i}$				
-------	----------	-------	---------------	--	--	--	--

Data Card Definitions:

Card 1	1	2	3	4	5	6	7	8
Variable	MID	RO	BULK	PCF	EF	TREF	A	B
Type	A	F	F	F	F	F	F	F

VARIABLE**DESCRIPTION**

MID	Material identification. A unique number or label must be specified (see *PART).
RO	Mass density
BULK	Elastic bulk modulus
PCF	Tensile pressure elimination flag for solid elements only. If set to unity, tensile pressures are set to zero.
EF	Elastic flag: EQ.0: The layer is viscoelastic. EQ.1: The layer is elastic.
TREF	Reference temperature for shift function (must be greater than zero)
A	Coefficient for the Arrhenius and the Williams-Landel-Ferry shift functions
B	Coefficient for the Williams-Landel-Ferry shift function

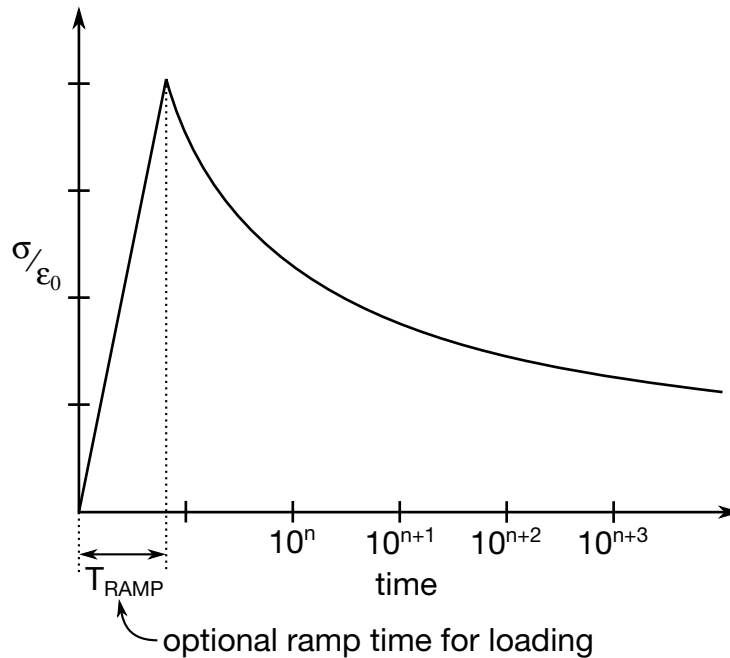

Figure M76-1. Relaxation curves for deviatoric behavior and bulk behavior. The ordinate of LCID is the deviatoric stress divided by 2 times the constant value of deviatoric strain where the stress and strain are in the direction of the prescribed strain, or in non-directional terms, the effective stress divided by 3 times the effective strain. LCIDK defines the mean stress divided by the constant value of volumetric strain imposed in a hydrostatic stress relaxation experiment as a function of time. For best results, the points defined in the curve should be equally spaced on the logarithmic scale. *Note the values for the abscissa are input as time, not log(time).* Furthermore, the curve should be smooth and defined in the positive quadrant. If nonphysical values are determined by least squares fit, LS-DYNA will terminate with an error message after the initialization phase is completed. If the ramp time for loading is included, then the relaxation which occurs during the loading phase is taken into account. This effect may or may not be important.

Relaxation Curve Card. Leave blank if the *Prony Series Cards* are used below. Also, leave blank if an elastic layer is defined in a laminated shell.

Card 2	1	2	3	4	5	6	7	8
Variable	LCID	NT	BSTART	TRAMP	LCIDK	NTK	BSTARTK	TRAMPK
Type	F	I	F	F	F	I	F	F

VARIABLE	DESCRIPTION
LCID	Load curve ID for deviatoric relaxation behavior. If LCID is given, constants G_i , and β_i are determined using a least squares fit. See Figure M76-1 for an example relaxation curve.
NT	Number of terms in shear fit. If zero, the default is 6. Fewer than NT terms will be used if the fit produces one or more negative shear moduli. Currently, the maximum number is set to 18.
BSTART	In the fit, β_1 is set to zero, β_2 is set to BSTART, β_3 is 10 times β_2 , β_4 is 10 times β_3 , and so on. If zero, BSTART is determined by an iterative trial and error scheme.
TRAMP	Optional ramp time for loading.
LCIDK	Load curve ID for bulk relaxation behavior. If LCIDK is given, constants K_i , and β_{ki} are determined via a least squares fit. See Figure M76-1 for an example relaxation curve.
NTK	Number of terms desired in bulk fit. If zero, the default is 6. Currently, the maximum number is set to 18.
BSTARTK	In the fit, β_{k1} is set to zero, β_{k2} is set to BSTARTK, β_{k3} is 10 times β_{k2} , β_{k4} is 100 times β_{k3} , and so on. If zero, BSTARTK is determined by an iterative trial and error scheme.
TRAMPK	Optional ramp time for bulk loading.

Moisture Card. Additional card for the MOISTURE keyword option.

Card 3	1	2	3	4	5	6	7	8
Variable	MO	ALPHA	BETA	GAMMA	MST			
Type	F	F	F	F	F			

VARIABLE	DESCRIPTION
MO	Initial moisture, M_0 . Defaults to zero.
ALPHA	Specifies α as a function of moisture. GT.0.0: Specifies a curve ID. LT.0.0: Specifies the negative of a constant value.

VARIABLE	DESCRIPTION
-----------------	--------------------

BETA	<p>Specifies β as a function of moisture.</p> <p>GT.0.0: Specifies a curve ID.</p> <p>LT.0.0: Specifies the negative of a constant value.</p>
GAMMA	<p>Specifies γ as a function of moisture.</p> <p>GT.0.0: Specifies a curve ID.</p> <p>LT.0.0: Specifies the negative of a constant value.</p>
MST	<p>Moisture, M. If the moisture is 0.0, the moisture option is disabled.</p> <p>GT.0.0: Specifies a curve ID giving moisture as a function of time.</p> <p>LT.0.0: Specifies the negative of a constant value of moisture.</p>

Prony Series cards. Card Format for viscoelastic constants. Up to 18 cards may be input. If fewer than 18 cards are used, the next keyword ("*") card terminates this input. These cards are not needed if relaxation data is defined. The number of terms for the shear behavior may differ from that for the bulk behavior: insert zero if a term is not included. If an elastic layer is defined you only need to define G_i and K_i (note in an elastic layer only one card is needed)

Card 4	1	2	3	4	5	6	7	8
Variable	G_i	$BETA_i$	K_i	$BETA K_i$				
Type	F	F	F	F				

VARIABLE	DESCRIPTION
-----------------	--------------------

G_i	Optional shear relaxation modulus for the i^{th} term
$BETA_i$	Optional shear decay constant for the i^{th} term
K_i	Optional bulk relaxation modulus for the i^{th} term
$BETA K_i$	Optional bulk decay constant for the i^{th} term

Remarks:

Rate effects are taken into account through linear viscoelasticity by a convolution integral of the form:

$$\sigma_{ij} = \int_0^t g_{ijkl}(t - \tau) \frac{\partial \epsilon_{kl}}{\partial \tau} d\tau$$

where $g_{ijkl}(t - \tau)$ is the relaxation functions for the different stress measures. This stress is added to the stress tensor determined from the strain energy functional.

If we wish to include only simple rate effects, the relaxation function is represented by 18 terms from the Prony series:

$$g(t) = \sum_{m=1}^N G_m e^{-\beta_m t}$$

We characterize this in the input by shear moduli, G_i , and decay constants, β_i . An arbitrary number of terms, up to 18, may be used when applying the viscoelastic model.

For volumetric relaxation, the relaxation function is also represented by the Prony series in terms of bulk moduli:

$$k(t) = \sum_{m=1}^N K_m e^{-\beta_{k_m} t}$$

The Arrhenius and Williams-Landel-Ferry (WLF) shift functions account for the effects of the temperature on the stress relaxation. A scaled time, t' ,

$$t' = \int_0^t \Phi(T) dt$$

is used in the relaxation function instead of the physical time. The Arrhenius shift function is

$$\Phi(T) = \exp \left[-A \left(\frac{1}{T} - \frac{1}{T_{\text{REF}}} \right) \right]$$

and the Williams-Landel-Ferry shift function is

$$\Phi(T) = \exp \left(-A \frac{T - T_{\text{REF}}}{B + T - T_{\text{REF}}} \right)$$

If all three values (T_{REF} , A , and B) are nonzero, the WLF function is used; the Arrhenius function is used if B is zero; and no scaling is applied if all three values are zero.

The moisture model allows the scaling of the material properties as a function of the moisture content of the material. The shear and bulk moduli are scaled by α , the decay constants are scaled by β , and a moisture strain, $\gamma(M)[M - M_0]$ is introduced analogous to the thermal strain.

***MAT_HYPERELASTIC_RUBBER**

This is Material Type 77. This material model provides a general hyperelastic rubber model combined optionally with linear viscoelasticity as outlined by Christensen [1980].

Card Summary:

Card 1. This card is required.

MID	RO	PR	N	NV	G	SIGF	REF
-----	----	----	---	----	---	------	-----

Card 2. This card is included if and only if PR < 0.

TBHYS							
-------	--	--	--	--	--	--	--

Card 3a. This card is included if and only if N > 0.

SGL	SW	ST	LCID1	DATA	LCID2	BSTART	TRAMP
-----	----	----	-------	------	-------	--------	-------

Card 3b. This card is included if and only if N = 0.

C10	C01	C11	C20	C02	C30	THERML	
-----	-----	-----	-----	-----	-----	--------	--

Card 4. Include up to 12 of this card. The next keyword (“*”) card terminates this input. Note that VFLAG is only included in the first card of this set.

G_i	$BETA_i$	G_j	$SIGF_j$	VFLAG			
-------	----------	-------	----------	-------	--	--	--

Data Card Definitions:

Card 1	1	2	3	4	5	6	7	8
Variable	MID	RO	PR	N	NV	G	SIGF	REF
Type	A	F	F	I	I	F	F	F

VARIABLE

DESCRIPTION

MID Material identification. A unique number or label must be specified (see *PART).

RO Mass density

VARIABLE	DESCRIPTION
PR	Poisson's ratio ($> .49$ is recommended, smaller values may not work and should not be used). If this is set to a negative number, then the absolute value is used and an extra card is read for the Mullins effect.
N	Number of hyperelastic constants to solve for from LCID1: EQ.0: set hyperelastic constants directly. EQ.1: solve for C10 and C01. EQ.2: solve for C10, C01, C11, C20, and C02. EQ.3: solve for C10, C01, C11, C20, C02, and C30.
NV	Number of Prony series terms used in fitting curve LCID2. If zero, the default is 6. Currently, the maximum number is set to 12. Values less than 12, possibly 3 - 5 are recommended, since each term used adds significantly to the cost. Caution should be exercised when taking the results from the fit. Preferably, all generated coefficients should be positive. Negative values may lead to unstable results. Once a satisfactory fit has been achieved it is recommended that the coefficients which are written into the output file be input in future runs.
G	Shear modulus for frequency independent damping. Frequency independent damping is based on a spring and slider in series. The critical stress for the slider mechanism is SIGF defined below. For the best results, the value of G should be 250 - 1000 times greater than SIGF.
SIGF	Limit stress for frequency independent frictional damping
REF	Use reference geometry to initialize the stress tensor. The reference geometry is defined by the keyword: *INITIAL_FOAM_REFERENCE_GEOMETRY. EQ.0.0: off EQ.1.0: on

Hysteresis Card. Additional card read in when PR < 0 (Mullins Effect).

Card 2	1	2	3	4	5	6	7	8
Variable	TBHYS							
Type	F							

VARIABLE

DESCRIPTION

TBHYS

Table ID for hysteresis, could be positive or negative; see [Remarks 1](#) and [2](#). This only applies to solid elements.

Card 3 for N > 0. For N > 0 a least squares fit is computed from uniaxial data.

Card 3a	1	2	3	4	5	6	7	8
Variable	SGL	SW	ST	LCID1	DATA	LCID2	BSTART	TRAMP
Type	F	F	F	F	F	F	F	F

VARIABLE

DESCRIPTION

SGL

Specimen gauge length

SW

Specimen width

ST

Specimen thickness

LCID1

Load curve ID giving the force as a function of actual change in the gauge length. If SGL, SW, and ST are set to unity (1.0), then curve LCID1 is also engineering stress as a function of engineering strain. Curve should have both negative (compressive) and positive (tensile) values.

DATA

Type of experimental data:

EQ.0.0: uniaxial data (only option for this model)

VARIABLE	DESCRIPTION
LCID2	Load curve ID of the deviatoric stress relaxation curve, neglecting the long term deviatoric stress. If LCID2 is specified, constants G_i and β_i are determined internally using a least squares fit. See Figure M76-1 for an example relaxation curve. The ordinate of the curve is the viscoelastic deviatoric stress divided by 2 times the constant value of deviatoric strain where the stress and strain are in the direction of the prescribed strain, or in non-directional terms, the effective stress divided by 3 times the effective strain.
BSTART	In the fit, β_1 is set to zero, β_2 is set to BSTART, β_3 is 10 times β_2 , β_4 is 10 times β_3 , and so on. If zero, BSTART is determined by an iterative trial and error scheme.
TRAMP	Optional ramp time for loading

Card 3 for N = 0. Set the hyperelastic material parameters directly.

Card 3b	1	2	3	4	5	6	7	8
Variable	C10	C01	C11	C20	C02	C30	THERML	
Type	F	F	F	F	F	F	F	

VARIABLE	DESCRIPTION
C10	C_{10}
C01	C_{01}
C11	C_{11}
C20	C_{20}
C02	C_{02}
C30	C_{30}

VARIABLE	DESCRIPTION
THERML	Flag for the thermal option. If THERML > 0.0, then G, SIGF, C10 and C01 must <i>all</i> specify curve IDs (zero is not permitted) that define the values as functions of temperature. If THERML < 0.0, then G, SIGF, C10 and C01, C11, C20, C02, and C30 must <i>all</i> specify curve IDs (zero is not permitted) that define the values as functions of temperature. A 'flat' curve may be used to define a constant value that does not change with temperature. This thermal option is available only for solid elements.

Optional Viscoelastic Constants & Frictional Damping Constant Cards. Up to 12 cards may be input. The next keyword ("*") card terminates this input.

Card 4	1	2	3	4	5	6	7	8
Variable	G_i	BETA i	G_j	SIGF j	VFLAG			
Type	F	F	F	F	F			

VARIABLE	DESCRIPTION
G_i	Optional shear relaxation modulus for the i^{th} term. Not used if LCID2 is given.
BETA i	Optional decay constant of the i^{th} term. Not used if LCID2 is given.
G_j	Optional shear modulus for frequency independent damping represented as the j^{th} spring and slider in series in parallel to the rest of the stress contributions.
SIGF j	Limit stress for frequency independent, frictional, damping represented as the j^{th} spring and slider in series in parallel to the rest of the stress contributions.
VFLAG	Flag for the viscoelasticity formulation. This field appears only in the first Card 4 line. EQ.0: Standard viscoelasticity formulation (default) EQ.1: Viscoelasticity formulation using the instantaneous elastic stress (only applicable to solid elements).

Background:

Rubber is generally considered to be fully incompressible since the bulk modulus greatly exceeds the shear modulus in magnitude. To model the rubber as an unconstrained material a hydrostatic work term, $W_H(J)$, is included in the strain energy functional which is function of the relative volume, J , [Ogden 1984]:

$$W(J_1, J_2, J) = \sum_{p,q=0}^n C_{pq} (J_1 - 3)^p (J_2 - 3)^q + W_H(J)$$

$$J_1 = I_1 I_3^{-1/3}$$

$$J_2 = I_2 I_3^{-2/3}$$

In order to prevent volumetric work from contributing to the hydrostatic work the first and second invariants are modified as shown. This procedure is described in more detail by Sussman and Bathe [1987]. The second Piola-Kirchhoff and Cauchy stress tensors are obtained from the strain energy functional as

$$\mathbf{S} = \frac{\partial W}{\partial \mathbf{E}}, \quad \boldsymbol{\sigma}_W = \frac{1}{J} \mathbf{F} \mathbf{S} \mathbf{F}^T,$$

where \mathbf{E} is the Green strain tensor and \mathbf{F} is the deformation gradient. We use the subscript W here to denote the contribution from the strain energy potential, and with no other contributions the resulting Cauchy stress is simply

$$\boldsymbol{\sigma} = \boldsymbol{\sigma}_W.$$

Rate effects are taken into account through linear viscoelasticity by adding a sequence of stress contributions

$$\boldsymbol{\sigma}_V = \sum_{i=1}^n \boldsymbol{\sigma}_V^i$$

where each term is known as a *Prony* term. Each such stress component $\boldsymbol{\sigma}_V^i$ evolves with deformation and time as

$$(\boldsymbol{\sigma}_V^i)^\nabla = 2G_i(\mathbf{D} - e^{-\beta_i(t-t_0)} \beta_i \boldsymbol{\varepsilon}_V^i), \quad (\boldsymbol{\varepsilon}_V^i)^\nabla = e^{\beta_i(t-t_0)} \mathbf{D}.$$

Here ∇ denotes the Jaumann rate. \mathbf{D} is the rate-of-deformation tensor, t is time and t_0 is an arbitrary time point. Each term has an internal strain $\boldsymbol{\varepsilon}_V^i$ associated with itself, which incorporates the memory properties a viscoelastic material typically possesses. This stress is added to the stress tensor determined from the strain energy functional, so that

$$\boldsymbol{\sigma} = \boldsymbol{\sigma}_W + \boldsymbol{\sigma}_V.$$

This model is effectively a Maxwell fluid which consists of dampers and springs in series. An arbitrary number of such Prony terms can be input, each characterized by the shear modulus, G_i , and relaxation coefficient, β_i . To avoid a constant shear modulus from this viscoelastic formulation, a term in the series is included only when $\beta_i > 0$.

For the sake of understanding the influence these terms have on the rate effects of viscoelasticity, let's investigate the model in a situation with no spin and constant rate-of-deformation with $D \neq 0$. This means that the Jaumann rate is simply differentiation with time, and we can look at the implications a specific term has. To make some physical sense of things, we deal with both the no hyperelastic material present and the hyperelastic material present cases. For the latter we assume an elastic shear modulus, G , for the hyperelastic material.

1. **Constant strain rate, D .** For the special case of constant strain rate, D , we have the following expression for the stress rate

$$\dot{\sigma}_V^i = 2G_i e^{-\beta_i t} D,$$

so each term contributes with an instantaneous shear stiffness of G_i that decays with time at a rate determined by β_i . If we define the relaxation time as

$$\tau_i = 1/\beta_i,$$

we see that the term will not contribute much to the response when $t > 5\tau_i$. So with several Prony terms with different relaxation properties, the overall viscoelastic stiffness decays roughly with steps of G_i in time spans of τ_i . This information can be used for determining the material data by making clever use of tensile tests at different strain rates. Looking at the corresponding stress contribution from each term

$$\sigma_V^i = 2 \frac{G_i}{\beta_i} (1 - e^{-\beta_i t}) D$$

we see that the stress stabilizes at a nonzero level $2 \frac{G_i}{\beta_i} D$ as time goes to infinity. See [Figure M77-1](#).

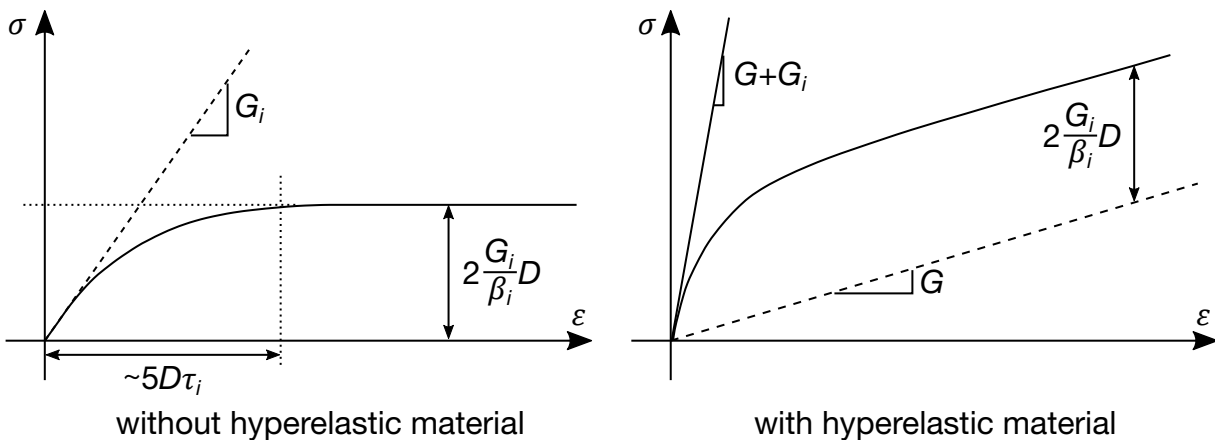

Figure M77-1. Material response with a constant strain rate

2. **Relaxation.** To see its effect on stress relaxation, we assume the material has deformed with a constant rate-of-deformation $D_0 \neq 0$ between time 0 and t_0 , and then continues with another constant rate-of-deformation D (which we allow to be zero) after time t_0 (see Figure M77-2). The expression for the stress is

$$\sigma_V^i = e^{-\beta_i(t-t_0)} \sigma_0^i + 2 \frac{G_i}{\beta_i} (1 - e^{-\beta_i(t-t_0)}) D,$$

where σ_0^i is the stress level that was reached at time t_0 . Stress relaxation occurs when $D = 0$ for which we see that the stress decays (or relaxes) to zero at a rate determined by β_i . When a hyperelastic material is included, the stress is relaxed to the hyperelastic stress, illustrated by a dashed line in the figure. As before, when combining many terms with different relaxation properties, the stress relaxes in steps of σ_0^i in time spans of τ_i and essentially determines the shape of the relaxation curve. This can also be used as a basis for estimating material parameters.

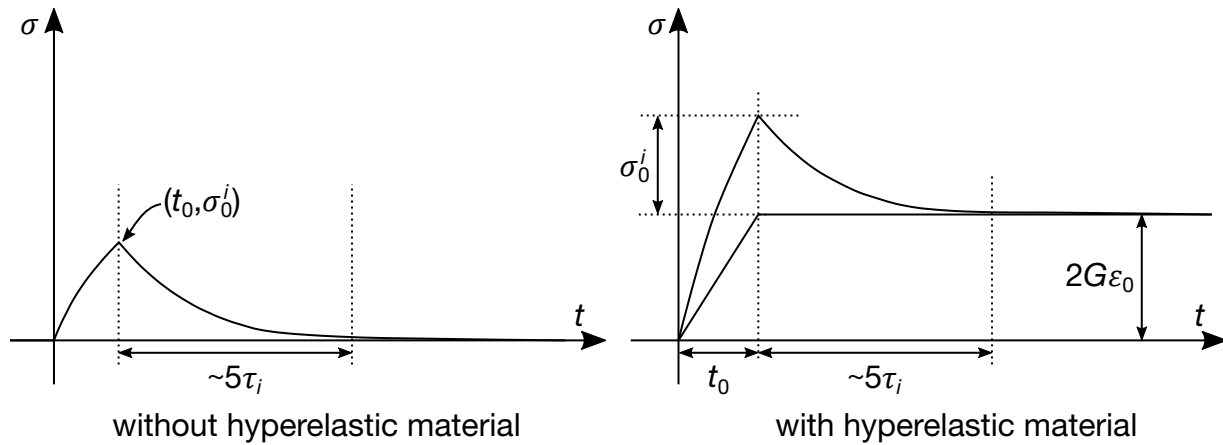

Figure M77-2. Stress relaxation curves

3. **Creep.** For creep, we assume the same situation but instead of prescribing the strain rate, D , we enforce the stress, σ , to be constant after time t_0 . The expression for the creep strain, ϵ_c , in the non-presence of a hyperelastic material becomes

$$\epsilon_c = \frac{\beta_i}{2G_i} (t - t_0) \sigma_0^i,$$

which indicates that the creep strain evolves linearly with time (see Figure M77-3). This is a rather non-physical behavior, but in the presence of a hyperelastic material the creep evolves as

$$\epsilon_c = \frac{1}{2G_i} \ln \left\{ \frac{G + G_i}{G + G_i e^{-\beta_i(t-t_0)}} \right\} \sigma_0^i$$

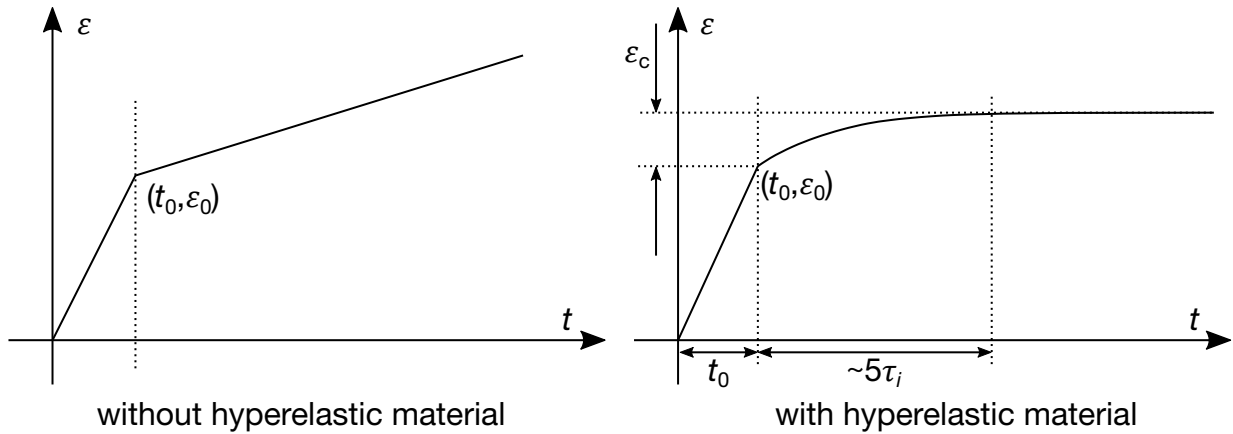
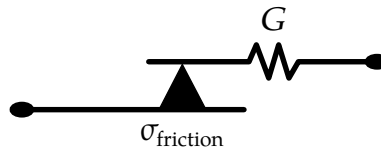

Figure M77-3. Creep curves

and saturates as one would expect to a constant value. With many such terms, the creep evolves in a quantitatively different manner, but the qualitative behavior is to be understood as described.

The Mooney-Rivlin rubber model (model 27) is obtained by specifying $N = 1$. Despite the differences in formulations, we find that the results obtained with this model are nearly identical with those of material 27 as long as large values of Poisson’s ratio are used.

Frequency independent damping is obtained by having a spring and slider in series as shown in the following sketch:



Several springs and sliders in series can be defined that are put in parallel to the rest of the stress contributions of this material model.

Remarks:

1. **Hysteresis (TBHYS > 0).** If a positive table ID for hysteresis is defined, then TBHYS is a table having curves that are functions of strain-energy density. Let W_{dev} be the current value of the deviatoric strain energy density as calculated above. Furthermore, let \bar{W}_{dev} be the peak strain energy density reached up to this point in time. It is then assumed that the resulting stress is reduced by a damage factor according to

$$S = D(W_{dev}, \bar{W}_{dev}) \frac{\partial W_{dev}}{\partial E} + \frac{\partial W_{vol}}{\partial E} ,$$

where $D(W_{\text{dev}}, \bar{W}_{\text{dev}})$ is the damage factor which is input as the table, TBHYS. This table consists of curves giving stress reduction (between 0 and 1) as a function of W_{dev} indexed by \bar{W}_{dev} .

Each \bar{W}_{dev} curve must be valid for strain energy densities between 0 and \bar{W}_{dev} . It is *recommended* that each curve be monotonically increasing, and it is *required* that each curve equals 1 when $W_{\text{dev}} > \bar{W}_{\text{dev}}$. Additionally, *DEFINE_TABLE *requires* that each curve have the same beginning and end point and, furthermore, that they not cross except at the boundaries, although they are not required to cross.

This table can be roughly estimated from a uniaxial quasistatic compression test as follows (see Figure for an illustration of the different curves):

- a) Load the specimen to a maximum displacement \bar{d} and measure the force as function of displacement, $f_{\text{load}}(d)$.
- b) Unload the specimen again measuring the force as a function of displacement, $f_{\text{unload}}(d)$.

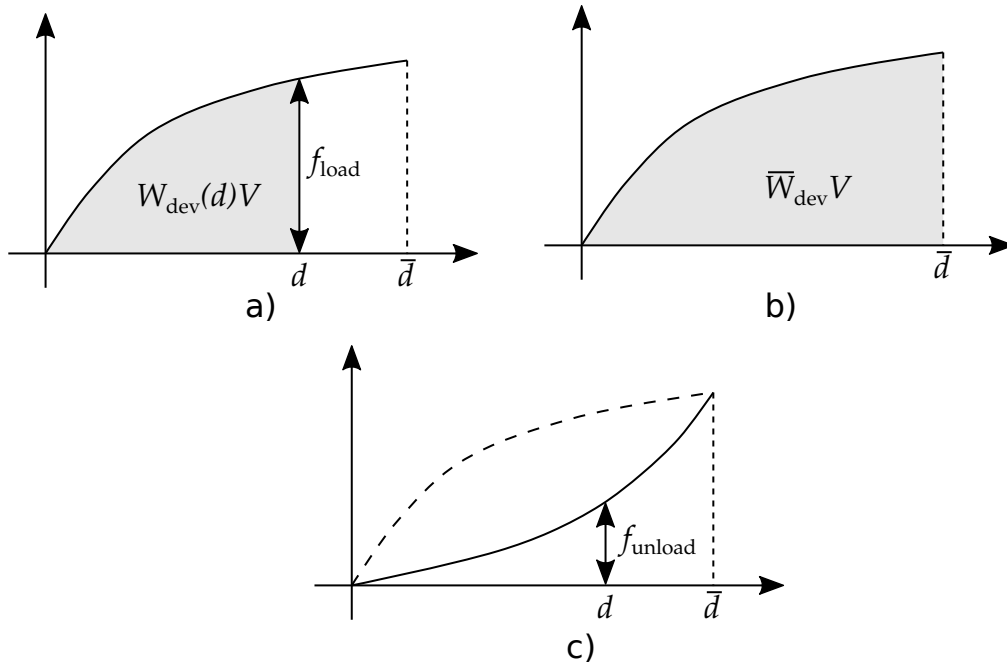

Figure M77-4. Illustration of curves needed from experiments to obtain $D(W_{dev}, \bar{W}_{dev})$. a) indicates the response during a uniaxial quasistatic compression test from which you can find $W_{dev}(d)$ (area under the curve). Each test is associated with a maximum displacement and thus a peak strain energy, \bar{W}_{dev} (area under the curve in b)). c) indicates the unloading curve during the test. Inverting $W_{dev}(d)$ allows you to find $D(W_{dev}, \bar{W}_{dev})$ from the loading and unloading curves for a value of \bar{W}_{dev} .

- c) The strain energy density is, then, given as a function of the loaded displacement as

$$W_{dev}(d) = \frac{1}{V} \int_0^d f_{load}(s) ds .$$

- i) The peak energy, which is used to index the data set, is given by

$$\bar{W}_{dev} = W_{dev}(\bar{d}) .$$

- ii) From this energy curve we can also determine the inverse, $d(W_{dev})$. Using this inverse the load curve for LS-DYNA is then given by:

$$D(W_{dev}, \bar{W}_{dev}) = \frac{f_{unload}[d(W_{dev})]}{f_{load}[d(W_{dev})]} .$$

- d) This procedure is repeated for different values of \bar{d} (or equivalently \bar{W}_{dev}).

2. **Hysteresis (TBHYS < 0).** If a negative table ID for hysteresis is defined, then all of the above holds with the difference being that the load curves comprising table, |TBHYS|, must give the strain-energy density, W_{dev} , as a function of the

stress reduction factor. *This scheme guarantees that all curves have the same beginning point, 0, and the same end point, 1.* For negative TBHYS the user provides $W_{\text{dev}}(D, \bar{W}_{\text{dev}})$ instead of $D(W_{\text{dev}}, \bar{W}_{\text{dev}})$. In practice, this case corresponds to swapping the load curve axes.

***MAT_OGDEN_RUBBER**

This is also Material Type 77. This material model provides the Ogden [1984] rubber model combined optionally with linear viscoelasticity as outlined by Christensen [1980].

Card Summary:

Card 1. This card is required.

MID	RO	PR	N	NV	G	SIGF	REF
-----	----	----	---	----	---	------	-----

Card 2. This card is read when PR < 0.

TBHYS							
-------	--	--	--	--	--	--	--

Card 3a. This card is included if N > 0.

SGL	SW	ST	LCID1	DATA	LCID2	BSTART	TRAMP
-----	----	----	-------	------	-------	--------	-------

Card 3b.1. This card is included if N = 0 or -1.

MU1	MU2	MU3	MU4	MU5	MU6	MU7	MU8
-----	-----	-----	-----	-----	-----	-----	-----

Card 3b.2. This card is included if N = 0 or -1.

ALPHA1	ALPHA2	ALPHA3	ALPHA4	ALPHA5	ALPHA6	ALPHA7	ALPHA8
--------	--------	--------	--------	--------	--------	--------	--------

Card 4. Include up to 12 of this card. This input ends with the next keyword ("*") card.

<i>G_i</i>	<i>BETA_i</i>	VFLAG					
----------------------	-------------------------	-------	--	--	--	--	--

Data Card Definitions:

Card 1	1	2	3	4	5	6	7	8
Variable	MID	RO	PR	N	NV	G	SIGF	REF
Type	A	F	F	I	I	F	F	F

VARIABLE

DESCRIPTION

MID

Material identification. A unique number or label must be specified (see *PART).

VARIABLE	DESCRIPTION
RO	Mass density
PR	Poisson's ratio ($\geq .49$ is recommended; smaller values may not work and should not be used). If this is set to a negative number, then the absolute value is used, and an extra card is read for Mullins effect.
N	<p>Order of fit to curve LCID1 for the Ogden model, (currently < 9, 2 generally works okay). The constants generated during the fit are printed in d3hsp and can be directly input in future runs, thereby, saving the cost of performing the nonlinear fit. The goodness of the fit can be visually evaluated by plotting data in the output file curveplot* using LS-PrePost (click <i>XYplot</i> \rightarrow <i>Add</i> to read the curveplot* file).</p> <p>EQ.0: Allows you to specify the material parameters directly with Cards 3b.1 and 3b.2</p> <p>EQ.-1: Same as $N = 0$ but invokes a thermal option: parameters MU_i and $ALPHA_i$ are read as load curves IDs and thereby define these parameters as functions of temperature. It is available only for solid elements. VFLAG must be 0.</p>
NV	<p>Number of Prony series terms for fitting curve LCID2. If zero, the default is 6. Currently, the maximum number is set to 12. Values less than 12, possibly 3 – 5, are recommended, since each term used adds significantly to the cost. Caution should be exercised when taking the results from the fit. Preferably, all generated coefficients should be positive. Negative values may lead to unstable results. Once a satisfactory fit has been achieved, it is recommended that the coefficients which are written into the output file be input in future runs.</p>
G	<p>Shear modulus for frequency independent damping. Frequency independent damping is based on a spring and slider in series. The critical stress for the slider mechanism is SIGF defined below. For the best results, the value of G should be 250 - 1000 times greater than SIGF.</p>
SIGF	Limit stress for frequency independent frictional damping
REF	<p>Use reference geometry to initialize the stress tensor. The reference geometry is defined by the keyword: *INITIAL_FOAM_REFERENCE_GEOMETRY.</p>

VARIABLE**DESCRIPTION**

EQ.0.0: Off

EQ.1.0: On

Hysteresis Card. Additional card read in when $PR < 0$ (Mullins Effect).

Card 2	1	2	3	4	5	6	7	8
Variable	TBHYS							
Type	F							

VARIABLE**DESCRIPTION**

TBHYS

Table ID for hysteresis, could be positive or negative; see [Remarks 1](#) and [2](#) in the manual page for *MAT_HYPERELASTIC_RUBBER. This only applies to solid elements.

Least Squares Card. For $N > 0$, a least squares fit to curve LCID1 is computed.

Card 3a	1	2	3	4	5	6	7	8
Variable	SGL	SW	ST	LCID1	DATA	LCID2	BSTART	TRAMP
Type	F	F	F	F	F	F		F

VARIABLE**DESCRIPTION**

SGL Specimen gauge length

SW Specimen width

ST Specimen thickness

LCID1 Load curve ID giving the force as a function of actual change in the gauge length. If SGL, SW, and ST are set to unity (1.0), then curve LCID1 is also engineering stress as a function of engineering strain. Curve should have both negative (compressive) and positive (tensile) values.

VARIABLE	DESCRIPTION
DATA	Type of experimental data: EQ.1.0: Uniaxial data (default) EQ.2.0: Biaxial data EQ.3.0: Pure shear data
LCID2	Load curve ID of the deviatoric stress relaxation curve, neglecting the long term deviatoric stress. If LCID2 is given, constants G_i and β_i are determined using a least squares fit. See M76-1 for an example relaxation curve. The ordinate of the curve is the viscoelastic deviatoric stress divided by the quantity 2 times the constant value of deviatoric strain where the stress and strain are in the direction of the prescribed strain. If in non-directional terms, it is the effective stress divided by the quantity 3 times the effective strain.
BSTART	In the fit, β_i is set to zero, β_2 is set to BSTART, β_3 is 10 times β_2 , β_4 is 10 times β_3 , and so on. If zero, BSTART is determined by an iterative trial and error scheme.
TRAMP	Optional ramp time for loading

Material Parameters Card. Include for N = 0 or N = -1 to set the material parameters directly.

Card 3b.1	1	2	3	4	5	6	7	8
Variable	MU1	MU2	MU3	MU4	MU5	MU6	MU7	MU8
Type	F	F	F	F	F	F	F	F

Material Parameters Card. Include for N = 0 or N = -1 to set the material parameters directly.

Card 3b.2	1	2	3	4	5	6	7	8
Variable	ALPHA1	ALPHA2	ALPHA3	ALPHA4	ALPHA5	ALPHA6	ALPHA7	ALPHA8
Type	F	F	F	F	F	F	F	F

VARIABLE	DESCRIPTION
MU <i>i</i>	μ_i , the i^{th} shear modulus ($N = 0$). i varies up to 8. For $N = -1$, each MU <i>i</i> is a load curve ID for specifying the i^{th} shear modulus as a function of temperature, that is, $\mu_i(T)$. If a curve ID is zero, then the corresponding shear modulus is a constant with value zero.
ALPHA <i>i</i>	α_i , the i^{th} exponent ($N = 0$). i varies up to 8. For $N = -1$, each ALPHA <i>i</i> is a load curve ID for specifying the i^{th} exponent as a function of temperature, that is, $\alpha_i(T)$. If a curve IDs is zero, then the corresponding exponent is a constant with value zero.

Optional Viscoelastic Constants Cards. Up to 12 cards may be input. The next keyword (“*”) card terminates this input if fewer than 12 cards are used.

Card 4	1	2	3	4	5	6	7	8
Variable	G_i	BETA <i>i</i>	VFLAG					
Type	F	F	I					
Default	none	none	0					

VARIABLE	DESCRIPTION
G_i	Optional shear relaxation modulus for the i^{th} term. Not used if LCID2 is given.
BETA <i>i</i>	Optional decay constant if i^{th} term. Not used if LCID2 is given.
VFLAG	Flag for the viscoelasticity formulation. This appears only on the first line defining G_i , BETA <i>i</i> , and VFLAG. If VFLAG = 0, the standard viscoelasticity formulation is used (the default), and if VFLAG = 1 (only applicable to solid elements), the viscoelasticity formulation using the instantaneous elastic stress is used.

Remarks:

Rubber is generally considered to be fully incompressible since the bulk modulus greatly exceeds the shear modulus in magnitude. To model the rubber as an unconstrained material, a hydrostatic work term is included in the strain energy functional that is a function of the relative volume, J , [Ogden 1984]:

$$W^* = \sum_{i=1}^3 \sum_{j=1}^n \frac{\mu_j}{\alpha_j} (\lambda_i^{*\alpha_j} - 1) + K(J - 1 - \ln J)$$

The asterisk (*) indicates that the volumetric effects have been eliminated from the principal stretches, λ_j^* . The number of terms, n , may vary from 1 to 8 inclusive, and K is the bulk modulus.

Rate effects are taken into account through linear viscoelasticity by a convolution integral of the form:

$$\sigma_{ij} = \int_0^t g_{ijkl}(t - \tau) \frac{\partial \varepsilon_{kl}}{\partial \tau} d\tau$$

or in terms of the second Piola-Kirchhoff stress, S_{ij} , and Green's strain tensor, E_{ij} ,

$$S_{ij} = \int_0^t G_{ijkl}(t - \tau) \frac{\partial E_{kl}}{\partial \tau} d\tau$$

where $g_{ijkl}(t - \tau)$ and $G_{ijkl}(t - \tau)$ are the relaxation functions for the different stress measures. This stress is added to the stress tensor determined from the strain energy functional.

If we wish to include only simple rate effects, the relaxation function is represented by six terms from the Prony series:

$$g(t) = \alpha_0 + \sum_{m=1}^N \alpha_m e^{-\beta t}$$

given by,

$$g(t) = \sum_{i=1}^n G_i e^{-\beta_i t} .$$

This model is effectively a Maxwell fluid which consists of a dampers and springs in series. We characterize this in the input by shear moduli, G_i , and decay constants, β_i . The viscoelastic behavior is optional, and an arbitrary number of terms may be used. In order to avoid a constant shear modulus from this viscoelastic formulation, a term in the series is included only when $\beta_i > 0$.

For VFLAG = 1, the viscoelastic term is

$$\sigma_{ij} = \int_0^t g_{ijkl}(t - \tau) \frac{\partial \sigma_{kl}^E}{\partial \tau} d\tau$$

where σ_{kl}^E is the instantaneous stress evaluated from the internal energy functional. The coefficients in the Prony series therefore correspond to normalized relaxation moduli instead of elastic moduli.

The Mooney-Rivlin rubber model (model 27) is obtained by specifying $n = 1$. In spite of the differences in formulations with Model 27, we find that the results obtained with this model are nearly identical with those of Material 27 as long as large values of Poisson's ratio are used.

The frequency independent damping is obtained by the having a spring and slider in series as shown in the following sketch:

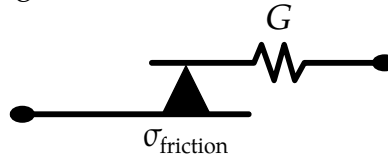

*MAT_SOIL_CONCRETE

This is Material Type 78. This model permits concrete and soil to be efficiently modeled. See the remarks below.

Card 1	1	2	3	4	5	6	7	8
Variable	MID	RO	G	K	LCPV	LCYP	LCFP	LCRP
Type	A	F	F	F	F	F	F	F

Card 2	1	2	3	4	5	6	7	8
Variable	PC	OUT	B	FAIL				
Type	F	F	F	F				

VARIABLE

DESCRIPTION

- MID Material identification. A unique number or label must be specified (see *PART).
- RO Mass density
- G Shear modulus
- K Bulk modulus
- LCPV Load curve ID for pressure as a function of volumetric strain. The pressure as a function of volumetric strain curve is defined in compression only. The sign convention requires that both pressure and compressive strain be defined as positive values where the compressive strain is taken as the negative value of the natural logarithm of the relative volume.
- LCYP Load curve ID for yield as a function of pressure:
 - GT.0: von Mises stress as a function of pressure,
 - LT.0: Second stress invariant, J_2 , as a function of pressure. This curve must be defined.

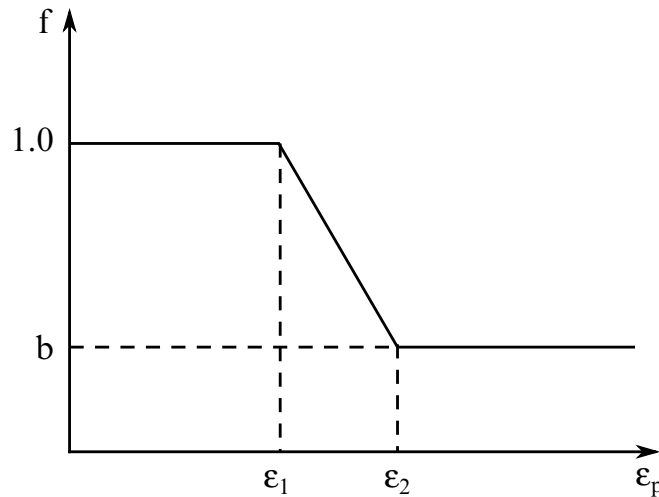

Figure M78-1. Strength reduction factor.

VARIABLE	DESCRIPTION
LCFP	Load curve ID for plastic strain at which fracture begins as a function of pressure. LCFP must be defined if B > 0.0.
LCRP	Load curve ID for plastic strain at which residual strength is reached as a function of pressure. LCRP must be defined if B > 0.0.
PC	Pressure cutoff for tensile fracture
OUT	Output option for plastic strain in database: EQ.0: Volumetric plastic strain EQ.1: Deviatoric plastic strain
B	Residual strength factor after cracking; see Figure M78-1 .
FAIL	Flag for failure: EQ.0: No failure EQ.1: When pressure reaches failure, pressure element is eroded. EQ.2: When pressure reaches failure, pressure element loses its ability to carry tension.

Remarks:

Pressure is positive in compression. Volumetric strain is defined as the natural log of the relative volume and is *positive* in compression where the relative volume, V , is the ratio of the current volume to the initial volume. The tabulated data should be given in order

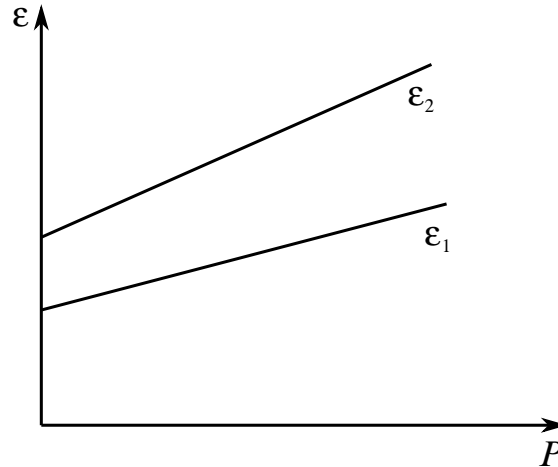

Figure M78-2. Cracking strain versus pressure.

of increasing compression. If the pressure drops below the cutoff value specified, it is reset to that value and the deviatoric stress state is eliminated.

If the load curve ID (LCYP) is provided as a positive number, the deviatoric, perfectly plastic, pressure dependent, yield function, ϕ , is given as

$$\phi = \sqrt{3J_2} - F(p) = \sigma_y - F(p)$$

where, $F(p)$ is a tabulated function of yield stress as a function of pressure, and the second invariant, J_2 , is defined in terms of the deviatoric stress tensor as:

$$J_2 = \frac{1}{2} S_{ij} S_{ij} .$$

If LCYP is negative, then the yield function becomes:

$$\phi = J_2 - F(p) .$$

If cracking is invoked by setting the residual strength factor, B , on Card 2 to a value between 0.0 and 1.0, the yield stress is multiplied by a factor f which reduces with plastic strain according to a trilinear law as shown in [Figure M78-1](#).

- b = residual strength factor
- ε_1 = plastic stain at which cracking begins
- ε_2 = plastic stain at which residual strength is reached

ε_1 and ε_2 are tabulated functions of pressure that are defined by load curves, see [Figure M78-2](#). The values on the curves are strain as a function of pressure and should be entered in order of increasing pressure. The strain values should always increase monotonically with pressure.

By properly defining the load curves, it is possible to obtain the desired strength and ductility over a range of pressures; see [Figure M78-3](#).

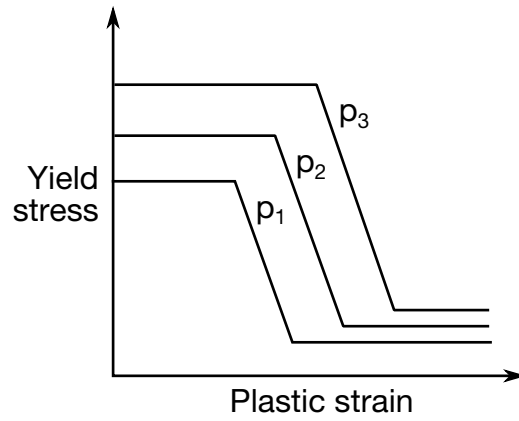

Figure M78-3. Yield stress as a function of plastic strain.

***MAT_HYSTERETIC_SOIL**

This is Material Type 79. For this material, you supply a shear stress-strain curve. LS-DYNA converts this curve into a nested surface model with up to twenty superposed “layers” of elastic-perfectly-plastic material, each with its own elastic modulus and yield stress. The hysteretic behavior follows from the yielding of the different “layers” at different stresses and follows the so-called “Masing” rules. See [Remarks](#) below.

Card 1	1	2	3	4	5	6	7	8
Variable	MID	RO	K0	P0	B	A0	A1	A2
Type	A	F	F	F	F	F	F	F

Card 2	1	2	3	4	5	6	7	8
Variable	DF	RP	LCID	SFLC	DIL_A	DIL_B	DIL_C	DIL_D
Type	F	F	F	F	F	F	F	F

Card 3	1	2	3	4	5	6	7	8
Variable	GAM1	GAM2	GAM3	GAM4	GAM5	LCD	LCSR	PINIT
Type	F	F	F	F	F	I	I	I

Card 4	1	2	3	4	5	6	7	8
Variable	TAU1	TAU2	TAU3	TAU4	TAU5	FLAG5		
Type	F	F	F	F	F			

This card is included if FLAG5 = 1.

Card 5	1	2	3	4	5	6	7	8
Variable	SIGTH	SIGR	CHI	TPINIT				
Type	F	F	F	F				

VARIABLE**DESCRIPTION**

MID	Material identification. A unique number or label must be specified (see *PART).
RO	Mass density
K0	Bulk modulus at the reference pressure
P0	Cut-off/datum pressure. P0 is irrelevant if $B = A1 = A2 = 0$. Otherwise, P0 must be < 0 (meaning tensile); a very small negative value is acceptable. Below this pressure, stiffness and strength go to zero. This is also the "zero" pressure for pressure-varying properties.
B	Exponent for the pressure-sensitive elastic moduli, b . See Remarks . B must be in the range $0 \leq B < 1$, and values too close to 1 are not recommended because the pressure becomes indeterminate.
A0	Yield function constant a_0 (default = 1.0); see Material Type 5.
A1	Yield function constant a_1 (default = 0.0); see Material Type 5.
A2	Yield function constant a_2 (default = 0.0); see Material Type 5.
DF	Damping factor (must be in the range $0 \leq DF \leq 1$): EQ.0: No damping EQ.1: Maximum damping
RP	Reference pressure for following input data
LCID	Load curve ID defining shear stress as a function of shear strain. Up to 20 points may be defined in the load curve. See *DEFINE_-CURVE.
SFLC	Scale factor to apply to shear stress in LCID

VARIABLE	DESCRIPTION
DIL_A	Dilation parameter A
DIL_B	Dilation parameter B
DIL_C	Dilation parameter C
DIL_D	Dilation parameter D
GAM1	γ_1 , shear strain (ignored if LCID is nonzero)
GAM2	γ_2 , shear strain (ignored if LCID is nonzero)
GAM3	γ_3 , shear strain (ignored if LCID is nonzero)
GAM4	γ_4 , shear strain (ignored if LCID is nonzero)
GAM5	γ_5 , shear strain (ignored if LCID is nonzero)
LCD	Optional load curve ID defining damping ratio of hysteresis at different strain amplitudes (overrides Masing rules for unload/reload). The x -axis is shear strain; the y -axis is the damping ratio (such as 0.05 for 5% damping). The strains (x -axis values) of curve LCD must be identical to those of curve LCID.
LCSR	Load curve ID defining plastic strain rate scaling effect on yield stress. See *DEFINE_CURVE. The x -axis is plastic strain rate; the y -axis is the yield enhancement factor.
PINIT	Flag for pressure sensitivity. Positive values apply to both B (elastic stiffness scaling) and the A0, A1, A2 equations (strength scaling). Negative values apply only to B, while the A0, A1, A2 equations use the current pressure like PINIT = 0. See TPINIT below for changing the time at which PINIT applies. See section Pressure sensitivity below. <p style="margin-left: 40px;"> PINIT .EQ.0: Use current pressure (will vary during the analysis).</p> <p style="margin-left: 40px;"> PINIT .EQ.1: Use pressure from initial stress state.</p> <p style="margin-left: 40px;"> PINIT .EQ.2: Use initial "plane stress" pressure $(\sigma_v + \sigma_h)/2$.</p> <p style="margin-left: 40px;"> PINIT .EQ.3: User (compressive) initial vertical stress.</p>
TAU1	τ_1 , shear stress at γ_1 (ignored if LCID is nonzero)
TAU2	τ_2 , shear stress at γ_2 (ignored if LCID is nonzero)

VARIABLE	DESCRIPTION
TAU3	τ_3 , shear stress at γ_3 (ignored if LCID is nonzero)
TAU4	τ_4 , shear stress at γ_4 (ignored if LCID is nonzero)
TAU5	τ_5 , shear stress at γ_5 (ignored if LCID is nonzero)
FLAG5	If FLAG5 = 1, optional Card 5 will be read.
SIGTH	Threshold shear stress ratio for cyclic degradation
SIGR	Residual shear stress ratio for cyclic degradation
CHI	Cyclic degradation parameter
TPINIT	Time at which PINIT applies. See section Pressure sensitivity below.

Remarks:

The elastic moduli G and K are pressure sensitive:

$$G(p) = \frac{G_0(p - p_0)^b}{(p_{\text{ref}} - p_0)^b}$$

$$K(p) = \frac{K_0(p - p_0)^b}{(p_{\text{ref}} - p_0)^b}$$

In the above K_0 is the input value K0, p is the current pressure, p_0 is the cut-off or datum pressure given by input value P0 (must be zero or negative), p_{ref} is the reference pressure given by the input value RP, b is the input value B, and G_0 is the initial shear modulus at small shear strain:

$$G_0 = \text{SFLC} \times \frac{\tau_1}{\gamma_1} .$$

In the above (γ_1, τ_1) is the first (nonzero) point in LCID. G_0 is also the total of the shear moduli of all the nested layers.

If p falls below p_0 (i.e., becomes more tensile than p_0), the shear stresses are set to zero and the pressure is set to p_0 . Thus, the material has no stiffness or strength in tension. The pressure in compression is calculated as follows:

$$p = p_{\text{ref}} \left[-\frac{K_0}{p_{\text{ref}}} \ln(V) \right]^{1/(1-b)}$$

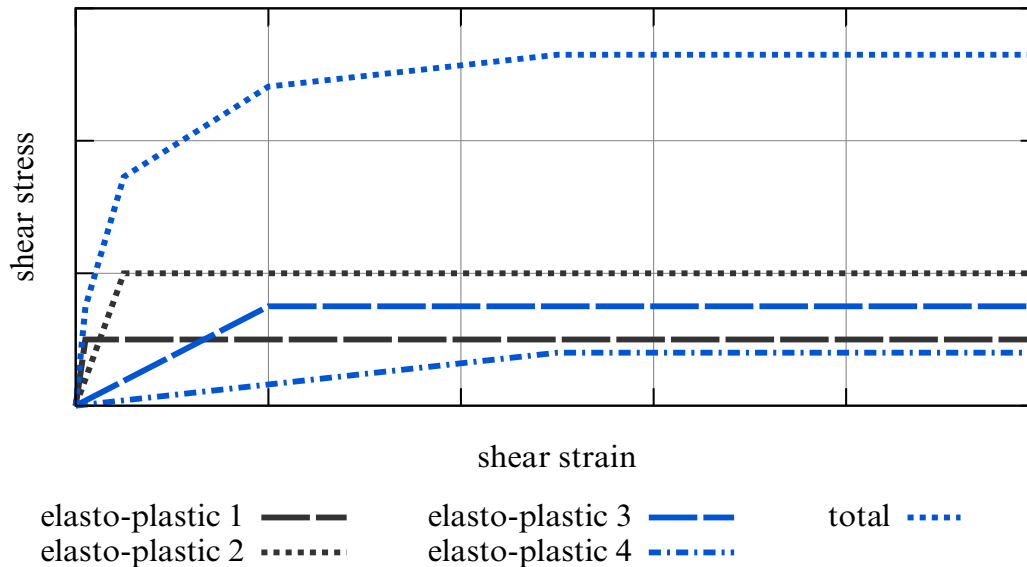

Figure M79-1. Family of stress-strain curves. The curve labeled total represents $LCID \times SFLC$. The other curves represent one “layer” in the material model.

where V is the relative volume, that is, the ratio between the original and current volume. This formula results in an instantaneous bulk modulus that is proportional to p^b and whose value at the reference pressure is equal to $K_0/(1 - b)$.

The stress-strain pairs in the load curve LCID define a curve of shear stress (τ) as a function of shear strain (γ). Starting from version R14, LCID may contain up to 20 points (in versions up to R13, the limit was 10 points). The first point on the curve is assumed by default to be (0,0) and does not need to be entered. The slope of the curve must decrease with increasing γ . This curve applies at the reference pressure; at other pressures, the curve is scaled by

$$\frac{\tau(p, \gamma)}{\tau(p_{\text{ref}}, \gamma)} = \sqrt{\frac{[a_0 + a_1(p - p_0) + a_2(p - p_0)^2]}{[a_0 + a_1(p_{\text{ref}} - p_0) + a_2(p_{\text{ref}} - p_0)^2]}}$$

The constants a_0 , a_1 , and a_2 govern the pressure sensitivity of the yield stress. Only the ratios between these values are important - the absolute stress values are taken from the stress-strain curve. The shear stress-strain curve (with points (γ_1, τ_1) , $(\gamma_2, \tau_2), \dots, (\gamma_N, \tau_N)$) is automatically converted into a series of N elastic-perfectly-plastic curves such that $\sum(\tau_i(\gamma)) = \tau(\gamma)$, as shown in [Figure M79-1](#).

Each elastic-perfectly-plastic curve represents one “layer” in the material model. Deviatoric stresses are stored and calculated separately for each layer. The total deviatoric stress is the sum of the deviatoric stresses in each layer. By this method, hysteretic (energy-absorbing) stress-strain curves are generated in response to any strain cycle of amplitude greater than the lowest yield strain of any layer. The example below ([Figure M79-2](#)) shows response to small and large strain cycles superposed on the input curve (thick line labeled backbone curve).

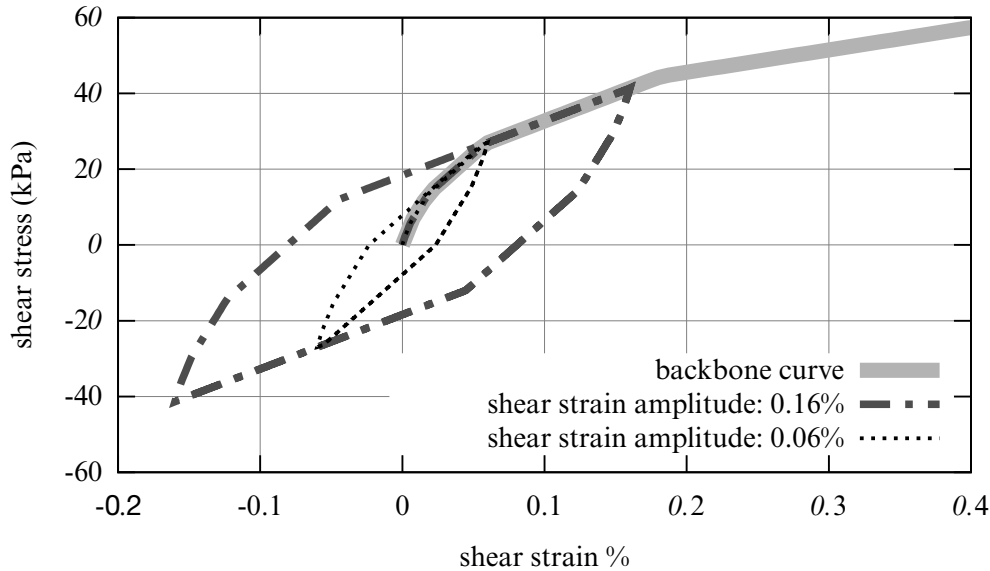

Figure M79-2. Small and large strain cycles superposed on the input curve

Definition of shear strain and shear stress:

Different definitions of “shear strain” and “shear stress” are possible when applied to three-dimensional stress states. MAT_079 uses the following definitions:

- Input shear stress is treated by the material model as,

$$0.5 \times \text{Von Mises Stress} = \sqrt{(3\sigma'_i: \sigma'_i/8)}.$$

- Input shear strain is treated by the material model as

$$1.5 \times \text{Von Mises Strain} = \sqrt{(3\varepsilon'_i: \varepsilon'_i/2)}.$$

For a particular stress or strain state (defined by the relationship between the three principal stresses or strains), a scaling factor may be needed to convert between the definitions given above and the shear stress or strain that an engineer would expect. The *MAT_079 definitions of shear stress and shear strain are derived from triaxial testing in which one principal stress is applied while the other two principal stresses are equal to a confining stress which is held constant. In other words, the principal stresses have the form $(a + q, a, a)$, and the shear stress as defined above is $0.5q$. If instead you wish the input curve to represent a test in which a pure shear strain is applied over a hydrostatic pressure, such as a shear-box test, then we recommend scaling both the x -axis and the y -axis of the curve by 0.866. This factor assumes principal stresses of the form $(p + t, p - t, p)$ where t is the applied shear stress, and similarly for the principal strains.

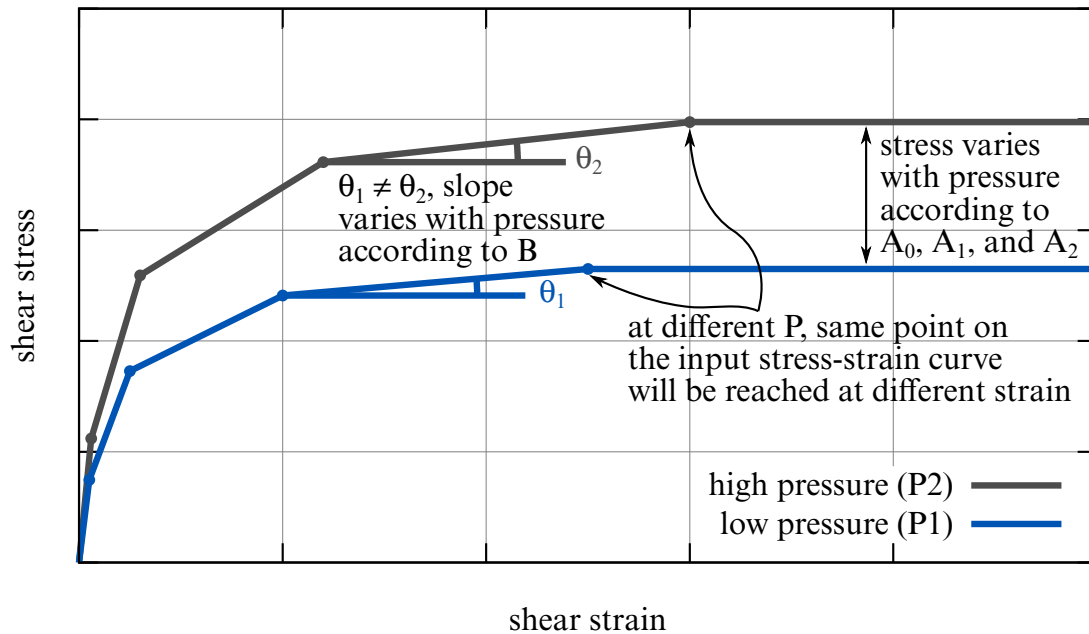

Figure M79-3. Sensitivity of curves to pressure

Pressure sensitivity:

The yield stresses of the layers, and hence the stress at each point on the shear stress-strain input curve, vary with pressure according to constants A_0 , A_1 and A_2 . The elastic moduli, and hence also the slope of each section of shear stress-strain curve, vary with pressure according to constant B . These effects combine to modify the shear stress-strain curve according to pressure as shown in [Figure M79-3](#).

PINIT and TPINIT

Pressure sensitivity can make the solution sensitive to numerical noise. In cases where the expected pressure changes are small compared to the initial stress state, using pressure from the initial stress state instead of current pressure as the basis for the pressure sensitivity (option PINIT) may be preferable. This causes the bulk modulus and shear stress-strain curve to be calculated once for each element at the start of the analysis and to remain fixed thereafter. Positive settings of PINIT affect both stiffness scaling (calculated using B) and strength scaling (calculated using A_0 , A_1 and A_2). If PINIT options 2 ("plane stress" pressure) or 3 (vertical stress) are used, these quantities substitute for pressure p in the equations above. Input values of p_{ref} and p_0 should then also be "plane stress" pressure or vertical stress, respectively. Negative settings of PINIT have these effects only on stiffness scaling (B), while the strength scaling is calculated from the current pressure as for PINIT = 0.

If PINIT is used, B is allowed to be as high as 1.0 (stiffness proportional to initial pressure); otherwise, values of B higher than about 0.5 are not recommended.

When TPINIT = 0.0 (the default), PINIT acts at the start of the analysis. The pressures that exist in each element on the first cycle (for instance, due to *INITIAL_STRESS... cards) will be used to set the pressure-sensitive stiffness and strength parameters for the whole analysis. If TPINIT is nonzero, the stiffness and strength properties vary dynamically with pressure until time TPINIT when they become frozen based on the pressure that exists at time TPINIT. This feature can be used to give time to apply gravity loading before applying PINIT. If dynamic relaxation is used and TPINIT > 0.0, then PINIT acts at time TPINIT in the transient phase.

Dilatancy:

Parameters DIL_A, DIL_B, DIL_C and DIL_D control the compaction and dilatancy that occur in sandy soils as a result of shearing motion. If this facility is used together with pore water pressure (see *CONTROL_PORE_FLUID), liquefaction can be modeled. However, note that the compaction/dilatancy algorithm used in this material model is very unsophisticated compared to recently published research findings.

The dilatancy is expressed as a volume strain, γ_v :

$$\begin{aligned}\varepsilon_v &= \varepsilon_r + \varepsilon_g \\ \varepsilon_r &= \text{DIL_A}(\Gamma)^{\text{DIL_B}} \\ \varepsilon_g &= \frac{\int (d\gamma_{xz}^2 + d\gamma_{yz}^2)^{1/2}}{\text{DIL_C} + \text{DIL_D} \times \int (d\gamma_{xz}^2 + d\gamma_{yz}^2)^{1/2}} \\ \Gamma &= (\gamma_{xz}^2 + \gamma_{yz}^2)^{1/2} \\ \gamma_{xz} &= 2\varepsilon_{xz} \\ \gamma_{yz} &= 2\varepsilon_{yz}\end{aligned}$$

γ_r describes the dilation of the soil due to the magnitude of the shear strains; this is caused by the soil particles having to climb over each other to develop shear strain. γ_g describes compaction of the soil due to collapse of weak areas and voids, caused by continuous shear straining.

Recommended inputs for sandy soil if dilatancy is to be modelled:

DIL_A	DIL_B	DIL_C	DIL_D
10	1.6	100	10

DIL_A and DIL_B may cause instabilities in some models.

Strain rate sensitivity:

Strain rate effect is accounted for by scaling the yield stress of each layer as the user-specified strain rate effect is accounted for by scaling the yield stress of each layer as the user-specified function of plastic strain rate. The stress-strain curve defined by LCID is for quasi-static loading. Scale factor (on the y -axis) as a function of strain rate (on the x -axis) is defined in curve LCSR. All scale factors must be equal to or larger than 1.0. Because the rate enhancement factor applies to the strength but not the stiffness, and is calculated separately for each layer, an overall enhancement factor between 1.0 and the value in LSCR will be observed in situations where not all the layers are yielding.

Cyclic degradation:

Cyclic degradation is accounted for by reducing the size of all yield surfaces proportionally based on the accumulation of the damage strain. The strength reduction factor, f , is determined by the following equation:

$$f = 1 - (1 - \Sigma_R) \left(1 - e^{\frac{-\chi \gamma_d}{1 - \Sigma_R}} \right)$$

where Σ is the shear stress ratio (defined as current shear stress divided by shear strength at the current pressure); Σ_R is the residual shear strength ratio SIGR; χ is the input parameter CHI; and γ_d is the damage strain, defined as the summation of absolute incremental changes in Von Mises strain that accumulate whenever the threshold shear stress ratio SIGTH is exceeded.

***MAT_RAMBERG-OSGOOD**

This is Material Type 80. This model is intended as a simple model of shear behavior and can be used in seismic analysis.

Card 1	1	2	3	4	5	6	7	8
Variable	MID	RO	GAMY	TAUY	ALPHA	R	BULK	
Type	A	F	F	F	F	F	F	

VARIABLE**DESCRIPTION**

MID	Material identification. A unique number or label must be specified (see *PART).
RO	Mass density
GAMY	Reference shear strain, γ_y
TAUY	Reference shear stress, τ_y
ALPHA	Stress coefficient, α
R	Stress exponent, r
BULK	Elastic bulk modulus

Remarks:

The Ramberg-Osgood equation is an empirical constitutive relation to represent the one-dimensional elastic-plastic behavior of many materials, including soils. This model allows a simple rate independent representation of the hysteretic energy dissipation observed in soils subjected to cyclic shear deformation. For monotonic loading, the stress-strain relationship is given by:

$$\frac{\gamma}{\gamma_y} = \frac{\tau}{\tau_y} + \alpha \left| \frac{\tau}{\tau_y} \right|^r \quad \text{for } \gamma \geq 0$$

$$\frac{\gamma}{\gamma_y} = \frac{\tau}{\tau_y} - \alpha \left| \frac{\tau}{\tau_y} \right|^r \quad \text{for } \gamma < 0$$

where γ is the shear and τ is the stress. The model approaches perfect plasticity as the stress exponent $r \rightarrow \infty$. These equations must be augmented to correctly model

unloading and reloading material behavior. The first load reversal is detected by $\dot{\gamma} < 0$. After the first reversal, the stress-strain relationship is modified to

$$\frac{(\gamma - \gamma_0)}{2\gamma_y} = \frac{(\tau - \tau_0)}{2\tau_y} + \alpha \left| \frac{(\tau - \tau_0)}{2\tau_y} \right|' \quad \text{for } \dot{\gamma} \geq 0$$
$$\frac{(\gamma - \gamma_0)}{2\gamma_y} = \frac{(\tau - \tau_0)}{2\tau_y} - \alpha \left| \frac{(\tau - \tau_0)}{2\tau_y} \right|' \quad \text{for } \dot{\gamma} < 0$$

where γ_0 and τ_0 represent the values of strain and stress at the point of load reversal. Subsequent load reversals are detected by $(\gamma - \gamma_0)\dot{\gamma} < 0$.

The Ramberg-Osgood equations are inherently one-dimensional and are assumed to apply to shear components. To generalize this theory to the multidimensional case, it is assumed that each component of the deviatoric stress and deviatoric tensorial strain is independently related by the one-dimensional stress-strain equations. A projection is used to map the result back into deviatoric stress space if required. The volumetric behavior is elastic, and, therefore, the pressure p is found by

$$p = -K\varepsilon_v$$

where ε_v is the volumetric strain.

***MAT_PLASTICITY_WITH_DAMAGE_{OPTION}**

This manual entry applies to *both* types 81 and 82. Materials 81 and 82 model an elasto-visco-plastic material with user-defined *isotropic* stress versus strain curves, which, themselves, may be strain-rate dependent. This model accounts for the effects of damage prior to rupture based on an effective plastic-strain measure. Additionally, failure can be triggered when the time step drops below some specified value. Adding an orthotropic damage option will invoke material type 82. Since type 82 must track directional strains it is, computationally, more expensive.

Available options include:

<BLANK>

ORTHO

ORTHO_RCDC

ORTHO_RCDC1980

STOCHASTIC

The keyword card can appear in the following ways:

*MAT_PLASTICITY_WITH_DAMAGE or *MAT_081

*MAT_PLASTICITY_WITH_DAMAGE_ORTHO or *MAT_082

*MAT_PLASTICITY_WITH_DAMAGE_ORTHO_RCDC or *MAT_082_RCDC

*MAT_PLASTICITY_WITH_DAMAGE_ORTHO_RCDC1980 or *MAT_082_RCDC1980

*MAT_PLASTICITY_WITH_DAMAGE_STOCHASTIC or *MAT_081_STOCHASTIC

The ORTHO option invokes an orthotropic damage model, an extension that was first added as for modelling failure in aluminum panels. Directional damage begins after a defined failure strain is reached in tension and continues to evolve until a tensile rupture strain is reached in either one of the two orthogonal directions. After rupture is detected at *all* integration points, the element is deleted.

The ORTHO_RCDC option invokes the damage model developed by Wilkins [Wilkins, et al. 1977]. The ORTHO_RCDC1980 option invokes a damage model based on strain invariants as developed by Wilkins [Wilkins, et al. 1980]. A nonlocal formulation, which requires additional storage, is used if a characteristic length is defined. The RCDC option, which was added at the request of Toyota, works well in predicting failure in cast aluminum; see Yamasaki, et al., [2006].

Card 1	1	2	3	4	5	6	7	8
Variable	MID	RO	E	PR	SIGY	ETAN	EPPF	TDEL
Type	A	F	F	F	F	F	F	F
Default	none	none	none	none	none	0.0	10 ¹²	0.0

Card 2	1	2	3	4	5	6	7	8
Variable	C	P	LCSS	LCSR	EPPFR	VP	LCDM	NUMINT
Type	F	F	F	F	F	F	F	I
Default	0	0	0	0	10 ¹⁴	0	0	0

Card 3	1	2	3	4	5	6	7	8
Variable	EPS1	EPS2	EPS3	EPS4	EPS5	EPS6	EPS7	EPS8
Type	F	F	F	F	F	F	F	F
Default	0	0	0	0	0	0	0	0

Card 4	1	2	3	4	5	6	7	8
Variable	ES1	ES2	ES3	ES4	ES5	ES6	ES7	ES8
Type	F	F	F	F	F	F	F	F
Default	0	0	0	0	0	0	0	0

Ortho RCDC Card. Additional card for keyword options ORTHO_RCDC and ORTHO_-RCDC1980.

Card 5	1	2	3	4	5	6	7	8
Variable	ALPHA	BETA	GAMMA	D0	B	LAMBDA	DS	L
Type	F	F	F	F	F	F	F	F
Default	0	0	0	0	0	0	0	0

VARIABLE**DESCRIPTION**

MID	Material identification. A unique number or label must be specified (see *PART).
RO	Mass density
E	Young's modulus
PR	Poisson's ratio
SIGY	Yield stress
ETAN	Tangent modulus, ignored if (LCSS > 0) is defined.
EPPF	$\epsilon_{failure}^p$, effective plastic strain at which material softening begins
TDEL	Minimum time step size for automatic element deletion
C	Strain rate parameter, C ; see formula below.
P	Strain rate parameter, P ; see formula below.
LCSS	Load curve ID or Table ID Load Curve. When LCSS is a load curve ID, it is taken as defining effective stress as a function of effective plastic strain. If defined, EPS1 - EPS8 and ES1 - ES8 are ignored.

VARIABLE	DESCRIPTION
	<p>Tabular Data. The table ID defines for each strain rate value a load curve ID giving the stress as a function effective plastic strain for that rate; see Figure M24-1. When the strain rate falls below the minimum value, the stress as a function of effective plastic strain curve for the lowest value of strain rate is used. Likewise, when the strain rate exceeds the maximum value the stress as a function of effective plastic strain curve for the highest value of strain rate is used. C, P, LCSR, EPS1 - EPS8, and ES1 - ES8 are ignored if a table ID is defined.</p> <p>Logarithmically Defined Tables. If the <i>first</i> value in the table is negative, LS-DYNA assumes that all the table values represent the natural logarithm of a strain rate. Since the tables are internally discretized to equally space the table values, it makes good sense from an accuracy standpoint that the table values represent the natural log of strain rate when the lowest strain rate and highest strain rate differ by several orders of magnitude.</p>
LCSR	Load curve ID defining strain rate scaling effect on yield stress
EPPFR	$\epsilon_{\text{rupture}}^p$, effective plastic strain at which material ruptures
VP	Formulation for rate effects: EQ.0.0: Scale yield stress (default) EQ.1.0: Viscoplastic formulation
LCDM	Optional curve ID defining nonlinear damage curve. If this curve is specified, either EPPF or EPPFR must also be input. If LCDM, EPPF, and EPPFR are all nonzero, then EPPFR is ignored.
NUMINT	Number of through thickness integration points which must fail before a shell element is deleted. (If zero, all points must fail.) The default of all integration points is not recommended since shells undergoing large strain are often not deleted due to nodal fiber rotations which limit strains at active integration points after most points have failed. Better results are obtained if NUMINT is set to 1 or a number less than one half of the number of through thickness points. For example, if four through thickness points are used, NUMINT should not exceed 2, even for fully integrated shells which have 16 integration points.
EPS1 - EPS8	Effective plastic strain values (optional if SIGY is defined). At least 2 points should be defined.

VARIABLE	DESCRIPTION
ES1 - ES8	Corresponding yield stress values to EPS1 - EPS8
ALPHA	Parameter α for the Rc-Dc model
BETA	Parameter β for the Rc-Dc model
GAMMA	Parameter γ for the Rc-Dc model
D0	Parameter D_0 for the Rc-Dc model
B	Parameter b for the Rc-Dc model
LAMBDA	Parameter λ for the Rc-Dc model
DS	Parameter D_s for the Rc-Dc model
L	Optional characteristic element length for this material. If zero, nodal values of the damage function are used to compute the damage gradient. See discussion below.

Remarks:

1. The stress strain behavior may be treated by a bilinear stress strain curve by defining the tangent modulus, ETAN. Alternately, a curve similar to that shown in [Figure M24-1](#) is expected to be defined by (EPS1, ES1) - (EPS8, ES8); however, an effective stress versus effective plastic strain curve (LCSS) may be input instead if eight points are insufficient. The cost is roughly the same for either approach. The most general approach is to use the table definition (LCSS) discussed below.

Three options to account for strain rate effects are possible:

- a) Strain rate may be accounted for using the Cowper and Symonds model which scales the yield stress with the factor

$$1 + \left(\frac{\dot{\epsilon}}{C} \right)^{1/6}$$

where $\dot{\epsilon}$ is the strain rate, $\dot{\epsilon} = \sqrt{\dot{\epsilon}_{ij}\dot{\epsilon}_{ij}}$.

If the viscoplastic option is active, VP = 1.0, and if SIGY is > 0, then the dynamic yield stress is computed from the sum of the static stress, $\sigma_y^s(\epsilon_{eff}^p)$, which is typically given by a load curve ID, and the initial yield stress, SIGY, multiplied by the Cowper-Symonds rate term as follows:

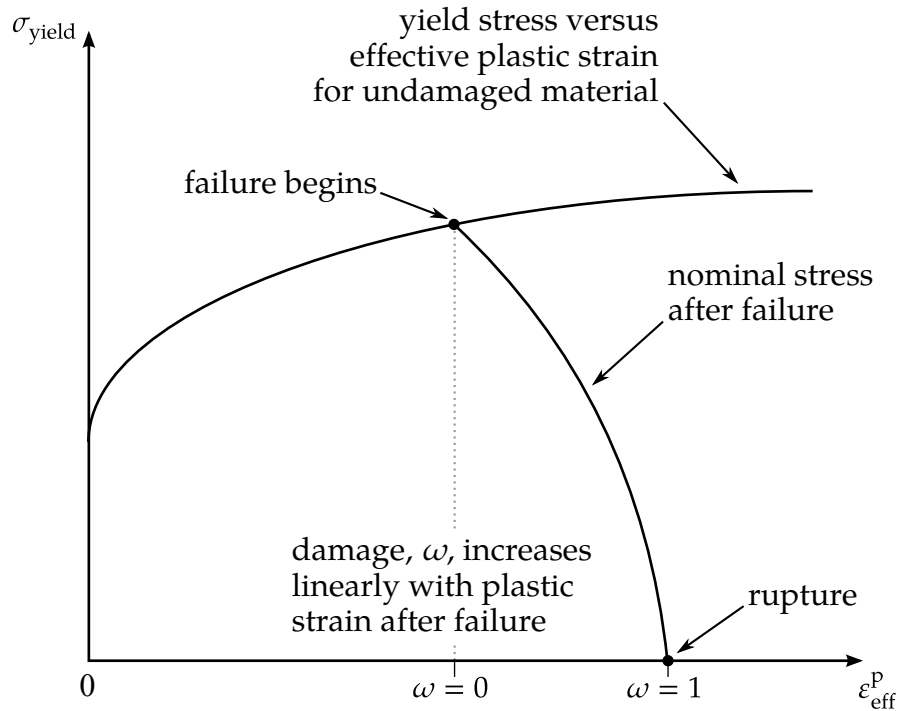

Figure M81-1. Stress strain behavior when damage is included

$$\sigma_y(\epsilon_{eff}^p, \dot{\epsilon}_{eff}^p) = \sigma_y^s(\epsilon_{eff}^p) + SIGY \times \left(\frac{\dot{\epsilon}_{eff}^p}{C} \right)^{1/p},$$

where the plastic strain rate is used. With this latter approach similar results can be obtained between this model and material model: *MAT_ANISOTROPIC_VISCOPLASTIC. If SIGY = 0, the following equation is used instead where the static stress, $\sigma_y^s(\epsilon_{eff}^p)$, must be defined by a load curve:

$$\sigma_y(\epsilon_{eff}^p, \dot{\epsilon}_{eff}^p) = \sigma_y^s(\epsilon_{eff}^p) \left[1 + \left(\frac{\dot{\epsilon}_{eff}^p}{C} \right)^{1/p} \right]$$

This latter equation is always used if the viscoplastic option is off.

- b) For complete generality a load curve (LCSR) to scale the yield stress may be input instead. In this curve the scale factor as a function of strain rate is defined.
 - c) If different stress as a function of strain curves can be provided for various strain rates, a table (LCSS) can be used. Then the table input in *DEFINE_TABLE is expected; see [Figure M24-1](#).
2. **Damage.** The constitutive properties for the damaged material are obtained from the undamaged material properties. The amount of damage is represented ω which varies from zero if no damage has occurred to unity for complete

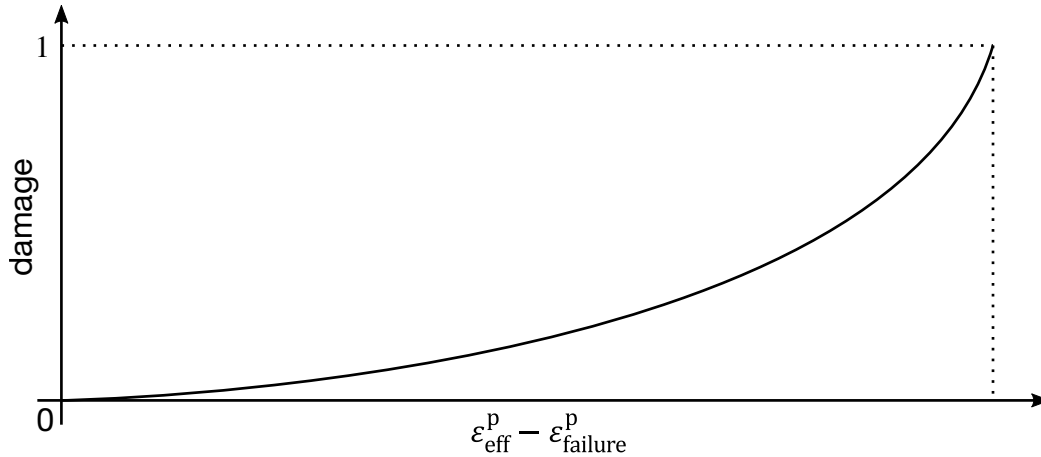

Figure M81-2. A nonlinear damage curve is optional. Note that the origin of the curve is at (0,0). The nonlinear damage curve is useful for controlling the softening behavior after the failure strain EPPF is reached.

rupture. For uniaxial loading, the nominal stress in the damaged material is given by

$$\sigma_{\text{nominal}} = \frac{P}{A}$$

where P is the applied load and A is the surface area. The true stress is given by:

$$\sigma_{\text{true}} = \frac{P}{A - A_{\text{loss}}}$$

where A_{loss} is the void area. The damage variable can then be defined:

$$\omega = \frac{A_{\text{loss}}}{A}$$

such that

$$0 \leq \omega \leq 1.$$

In this model, unless LCDM is defined, damage is defined in terms of effective plastic strain after the failure strain is exceeded as follows:

$$\omega = \frac{\epsilon_{\text{eff}}^p - \epsilon_{\text{failure}}^p}{\epsilon_{\text{rupture}}^p - \epsilon_{\text{failure}}^p}, \quad \epsilon_{\text{failure}}^p \leq \epsilon_{\text{eff}}^p \leq \epsilon_{\text{rupture}}^p$$

After exceeding the failure strain, softening begins and continues until the rupture strain is reached.

3. **Rc-Dc Model.** The damage, D , for the Rc-Dc model is given by:

$$D = \int \omega_1 \omega_2 d\epsilon^p$$

where ϵ^p is the effective plastic strain,

$$\omega_1 = \left(\frac{1}{1 - \gamma \sigma_m} \right)^\alpha$$

is a triaxial stress weighting term and

$$\omega_2 = (2 - A_D)^\beta$$

is an asymmetric strain weighting term. In the above σ_m is the mean stress. For A_D we use

$$A_D = \min \left(\left| \frac{\sigma_2}{\sigma_3} \right|, \left| \frac{\sigma_3}{\sigma_2} \right| \right) ,$$

where σ_i are the principal stresses and $\sigma_1 > \sigma_2 > \sigma_3$. Fracture is initiated when the accumulation of damage is

$$\frac{D}{D_c} > 1 ,$$

where D_c is the critical damage given by

$$D_c = D_0(1 + b|\nabla D|^\lambda) .$$

A fracture fraction,

$$F = \frac{D - D_c}{D_s} ,$$

defines the degradations of the material by the Rc-Dc model.

For the Rc-Dc model the gradient of damage needs to be estimated. The damage is connected to the integration points, and, thus, the computation of the gradient requires some manipulation of the LS-DYNA source code. Provided that the damage is connected to nodes, it can be seen as a standard bilinear field and the gradient is easily obtained. To enable this, the damage at the integration points are transferred to the nodes as follows. Let E_n be the set of elements sharing node n , $|E_n|$ be the number of elements in that set, P_e be the set of integration points in element e and $|P_e|$ be the number of points in that set. The average damage \bar{D}_e in element e is computed as

$$\bar{D}_e = \frac{\sum_{p \in P_e} D_p}{|P_e|}$$

where D_p is the damage in integration point p . Finally, the damage value in node n is estimated as

$$D_n = \frac{\sum_{e \in E_n} \bar{D}_e}{|E_n|} .$$

This computation is performed in each time step and requires additional storage. Currently we use three times the total number of nodes in the model for this calculation, but this could be reduced by a considerable factor if necessary.

There is an Rc-Dc option for the Gurson dilatational-plastic model. In the implementation of this model, the norm of the gradient is computed differently. Let E_f^l be the set of elements from within a distance l of element, f , not including the element itself, and let $|E_f^l|$ be the number of elements in that set. The norm of the gradient of damage is estimated roughly as

$$\|\nabla D\|_f \approx \frac{1}{|E_f^l|} \sum_{e \in E_f^l} \frac{|D_e - D_f|}{d_{ef}}$$

where d_{ef} is the distance between element f and e .

The reason for taking the first approach is that it should be a better approximation of the gradient; it can for one integration point in each element be seen as a weak gradient of an elementwise constant field. The memory consumption as well as computational work should not be much higher than for the other approach.

The RCDC1980 model is identical to the RCDC model except the expression for A_D is in terms of the principal stress deviators and takes the form

$$A_D = \max \left(\left| \frac{S_2}{S_3} \right|, \left| \frac{S_2}{S_1} \right| \right)$$

4. **STOCHASTIC Option.** The STOCHASTIC option allows spatially varying yield and failure behavior. See *DEFINE_STOCHASTIC_VARIATION for additional information.
5. **Material Histories.** *DEFINE_MATERIAL_HISTORIES can be used to output the instability, plastic strain rate, and damage, following

<i>*DEFINE_MATERIAL_HISTORIES Properties</i>					
Label	Attributes				Description
Instability	-	-	-	-	Failure indicator $\epsilon_{\text{eff}}^p / \epsilon_{\text{fail}}^p$, see EPPF
Plastic Strain Rate	-	-	-	-	Effective plastic strain rate $\dot{\epsilon}_{\text{eff}}^p$
Damage	-	-	-	-	Damage ω

*MAT_FU_CHANG_FOAM_{OPTION}

This is Material Type 83.

Available options include:

DAMAGE_DECAY

LOG_LOG_INTERPOLATION

Rate effects can be modeled in low and medium density foams; see [Figure M83-1](#). Hysteretic unloading behavior in this model is a function of the rate sensitivity with the most rate sensitive foams providing the largest hysteresis and vice versa. The unified constitutive equations for foam materials by Chang [1995] provide the basis for this model. The mathematical description given below is excerpted from the reference. Further improvements have been incorporated based on work by Hirth, Du Bois, and Weimar [1998]. Their improvements permit: load curves generated from a drop tower test to be directly input, a choice of principal or volumetric strain rates, load curves to be defined in tension, and the volumetric behavior to be specified by a load curve.

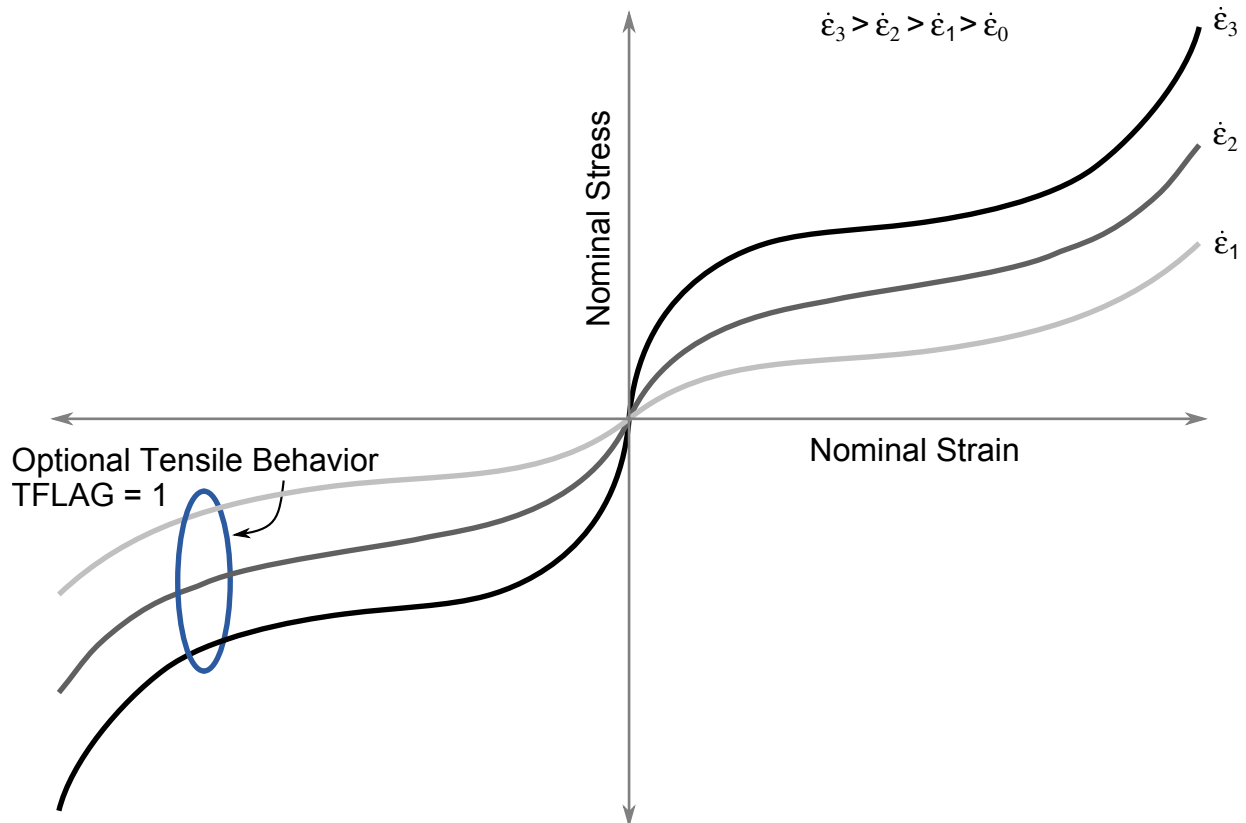

Figure M83-1. Rate effects in the nominal stress versus engineering strain curves, which are used to model rate effects in Fu Chang’s foam model.

The unloading response was generalized by Kolling, Hirth, Erhart and Du Bois [2006] to allow the Mullin's effect to be modeled, meaning after the first loading and unloading, further reloading occurs on the unloading curve. If it is desired to reload on the loading curves with the new generalized unloading, the DAMAGE_DECAY option is available which allows the reloading to quickly return to the loading curve as the damage parameter decays back to zero in tension and compression.

Card Summary:

Card 1. This card is required.

MID	RO	E	KCON	TC	FAIL	DAMP	TBID
-----	----	---	------	----	------	------	------

Card 2. This card is required.

BVFLAG	SFLAG	RFLAG	TFLAG	PVID	SRAF	REF	HU
--------	-------	-------	-------	------	------	-----	----

Card 3a. This card is included if the DAMAGE_DECAY keyword option is used.

MINR	MAXR	SHAPE	BETAT	BETAC			
------	------	-------	-------	-------	--	--	--

Card 3b. This card is included if the DAMAGE_DECAY keyword option is *not* used.

D0	N0	N1	N2	N3	C0	C1	C2
----	----	----	----	----	----	----	----

Card 4. This card is included if the DAMAGE_DECAY keyword option is *not* used.

C3	C4	C5	AIJ	SIJ	MINR	MAXR	SHAPE
----	----	----	-----	-----	------	------	-------

Card 5. This card is optional.

EXPON	RIULD						
-------	-------	--	--	--	--	--	--

Data Card Definitions:

Card 1	1	2	3	4	5	6	7	8
Variable	MID	RO	E	KCON	TC	FAIL	DAMP	TBID
Type	A	F	F	F	F	F	F	F
Default	none	none	none	none	10 ²⁰	none	0.05	none

VARIABLE	DESCRIPTION
MID	Material identification. A unique number or label must be specified (see *PART).
RO	Mass density
E	Young's modulus
KCON	Optional Young's modulus used to compute the sound speed. This will influence the time step, contact forces, hourglass stabilization forces, and the numerical damping (DAMP). If $TBID \neq 0$, the time step is based on a stiffness of $\max(KCON, E, \text{max. current slope of the stress-strain curve})$ The "max .current slope" is taken from the three principal directions. The tensile (negative) portion of the stress-strain curves is included in this evaluation if $TFLAG = 1$.
TC	Tension cut-off stress
FAIL	Failure option after cutoff stress is reached: EQ.0.0: Tensile stress remains at cut-off value. EQ.1.0: Tensile stress is reset to zero. EQ.2.0: The element is eroded.
DAMP	Viscous coefficient to model damping effects (0.05 < recommended value < 0.50; default is 0.05)
TBID	Table ID (see *DEFINE_TABLE) for nominal stress as a function of strain data at a given strain rate. If the table ID is provided, Cards 3 and 4 may be left blank and the input curves will be used directly in the model. The Table ID can be positive or negative (see Remark 6 below). If $TBID < 0$, enter $ TBID $ on the *DEFINE_TABLE keyword.

Card 2	1	2	3	4	5	6	7	8
Variable	BVFLAG	SFLAG	RFLAG	TFLAG	PVID	SRAF	REF	HU
Type	F	F	F	F	F	F	F	F
Default	0.0	0.0	0.0	0.0	0.0	0.0	0.0	0.0

VARIABLE**DESCRIPTION**

BVFLAG	Toggle to turn bulk viscosity off or on (see Remark 1): LT.1.0: No bulk viscosity (recommended) GE.1.0: Bulk viscosity active.
SFLAG	Strain rate flag (see Remark 2 below): EQ.0.0: True constant strain rate EQ.1.0: Engineering strain rate
RFLAG	Strain rate evaluation flag (see Remark 3): EQ.0.0: First principal direction EQ.1.0: Principal strain rates for each principal direction EQ.2.0: Volumetric strain rate
TFLAG	Tensile stress evaluation: EQ.0.0: Linear (follows E) in tension EQ.1.0: Input via load curves with the tensile response corresponds to negative values of stress and strain.
PVID	Optional load curve ID defining pressure as a function of volumetric strain. See Remark 4 .
SRAF	Strain rate averaging flag (see Remark 5): LT.0.0: Use exponential moving average. EQ.0.0: Use weighted running average. GT.0.0.AND.LE.0.9999: Filter window for averaging strain rates, suppressing the time step dependence of the operation.

VARIABLE	DESCRIPTION
	EQ.1.0: Average the last twelve values.
	GE.1.0001: SRAF – 1.0 is a filter window for averaging strain rates, suppressing the time step dependence of the operation.
REF	Use reference geometry to initialize the stress tensor. The reference geometry is defined by the keyword: *INITIAL_FOAM_REFERENCE_GEOMETRY. EQ.0.0: Off EQ.1.0: On
HU	Hysteretic unloading factor between 0.0 and 1.0. See Remark 6 and Figure M83-4 .

DAMAGE_DECAY Card. Card 3 for DAMAGE_DECAY keyword option.

Card 3a	1	2	3	4	5	6	7	8
Variable	MINR	MAXR	SHAPE	BETAT	BETAC			
Type	F	F	F	F	F			
Default	0.0	0.0	0.0	0.0	0.0			

VARIABLE	DESCRIPTION
MINR	Minimum strain rate of interest
MAXR	Maximum strain rate of interest
SHAPE	Shape factor for unloading. Active for nonzero values of the hysteretic unloading factor HU. Values less than one reduces the energy dissipation and greater than one increases dissipation; see Figure M83-2 .
BETAT	Decay constant for damage in tension. The damage decays after loading ceases according to $e^{-BETAT \times t}$.
BETAC	Decay constant for damage in compression. The damage decays after loading ceases according to $e^{-BETAC \times t}$.

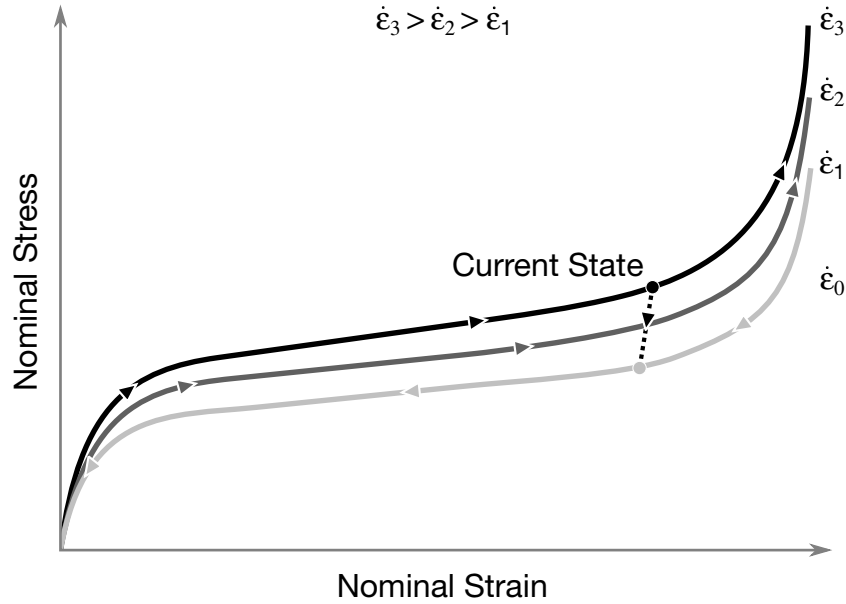

Figure M83-2. HU = 0, TBID > 0

Material Constants Card. Card 3 for keyword option *NOT* set to DAMAGE_DECAY.

Card 3b	1	2	3	4	5	6	7	8
Variable	D0	N0	N1	N2	N3	C0	C1	C2
Type	F	F	F	F	F	F	F	F
Default	0.0	0.0	0.0	0.0	0.0	0.0	0.0	0.0

VARIABLE

DESCRIPTION

- D0 Material constant; see [Material Formulation](#).
- N0 Material constant; see [Material Formulation](#).
- N1 Material constant; see [Material Formulation](#).
- N2 Material constant; see [Material Formulation](#).
- N3 Material constant; see [Material Formulation](#).
- C0 Material constant; see [Material Formulation](#).
- C1 Material constant; see [Material Formulation](#).
- C2 Material constant; see [Material Formulation](#).

VARIABLE	DESCRIPTION
C3	Material constant; see Material Formulation .
C4	Material constant; see Material Formulation .
C5	Material constant; see Material Formulation .
AIJ	Material constant; see Material Formulation .
SIJ	Material constant; see Material Formulation .

Material Constants Card. Card 4 for keyword option *NOT* set to DAMAGE_DECAY.

Card 4	1	2	3	4	5	6	7	8
Variable	C3	C4	C5	AIJ	SIJ	MINR	MAXR	SHAPE
Type	F	F	F	F	F	F	F	F
Default	0.0	0.0	0.0	0.0	0.0	0.0	0.0	0.0

VARIABLE	DESCRIPTION
C3	Material constant; see Material Formulation .
C4	Material constant; see Material Formulation .
C5	Material constant; see Material Formulation .
AIJ	Material constant; see Material Formulation .
SIJ	Material constant; see Material Formulation .
MINR	Minimum strain rate of interest
MAXR	Maximum strain rate of interest
SHAPE	Shape factor for unloading. Active for nonzero values of the hysteretic unloading factor HU. Values less than one reduces the energy dissipation and greater than one increases dissipation; see Figure M83-2 .

Unloading Card. This card is optional.

Card 5	1	2	3	4	5	6	7	8
Variable	EXPON	RIULD						
Type	F	F						
Default	1.0	0.0						

VARIABLE**DESCRIPTION**

EXPON

Exponent for unloading. Active for nonzero values of the hysteretic unloading factor HU. Default is 1.0

RIULD

Flag for rate independent unloading, see [Remark 6](#).

EQ.0.0: Off,

EQ.1.0: On.

Material Formulation:

The strain is divided into two parts: a linear part and a non-linear part of the strain

$$\mathbf{E}(t) = \mathbf{E}^L(t) + \mathbf{E}^N(t) ,$$

and the strain rate becomes

$$\dot{\mathbf{E}}(t) = \dot{\mathbf{E}}^L(t) + \dot{\mathbf{E}}^N(t) ,$$

where $\dot{\mathbf{E}}^N$ is an expression for the past history of \mathbf{E}^N . A postulated constitutive equation

may be written as:

$$\sigma(t) = \int_{\tau=0}^{\infty} [\mathbf{E}_t^N(\tau), \mathbf{S}(t)] d\tau ,$$

where $\mathbf{S}(t)$ is the state variable and $\int_{\tau=0}^{\infty}$ is a functional of all values of τ in $T_\tau: 0 \leq \tau \leq \infty$ and

$$\mathbf{E}_t^N(\tau) = \mathbf{E}^N(t - \tau) ,$$

where τ is the history parameter:

$$\mathbf{E}_t^N(\tau = \infty) \Leftrightarrow \text{the virgin material} .$$

It is assumed that the material remembers only its immediate past, that is, a neighborhood about $\tau = 0$. Therefore, an expansion of $\mathbf{E}_t^N(\tau)$ in a Taylor series about $\tau = 0$ yields:

$$\mathbf{E}_t^N(\tau) = \mathbf{E}^N(0) + \frac{\partial \mathbf{E}_t^N}{\partial t}(0)dt .$$

Hence, the postulated constitutive equation becomes:

$$\boldsymbol{\sigma}(t) = \boldsymbol{\sigma}^*[\mathbf{E}^N(t), \dot{\mathbf{E}}^N(t), \mathbf{S}(t)] ,$$

where we have replaced $\frac{\partial \mathbf{E}_t^N}{\partial t}$ by $\dot{\mathbf{E}}^N$, and $\boldsymbol{\sigma}^*$ is a function of its arguments.

For a special case,

$$\boldsymbol{\sigma}(t) = \boldsymbol{\sigma}^*(\mathbf{E}^N(t), \mathbf{S}(t)) ,$$

we may write

$$\dot{\mathbf{E}}^N = f(\mathbf{S}(t), \mathbf{s}(t))$$

which states that the nonlinear strain rate is the function of stress and a state variable which represents the history of loading. Therefore, the proposed kinetic equation for foam materials is:

$$\dot{\mathbf{E}}^N = \frac{\boldsymbol{\sigma}}{\|\boldsymbol{\sigma}\|} D_0 \exp \left\{ -c_0 \left[\frac{\boldsymbol{\sigma} : \mathbf{S}}{(\|\boldsymbol{\sigma}\|)^2} \right]^{2n_0} \right\} ,$$

where D_0 , c_0 , and n_0 are material constants, and \mathbf{S} is the overall state variable. If either $D_0 = 0$ or $c_0 \rightarrow \infty$ then the nonlinear strain rate vanishes.

$$\begin{aligned} \dot{S}_{ij} &= [c_1(a_{ij}R - c_2S_{ij})P + c_3W^{n_1}(\|\dot{\mathbf{E}}^N\|)^{n_2}I_{ij}]R \\ R &= 1 + c_4 \left[\frac{\|\dot{\mathbf{E}}^N\|}{c_5} - 1 \right]^{n_3} \\ P &= \boldsymbol{\sigma} : \dot{\mathbf{E}}^N \\ W &= \int \boldsymbol{\sigma} : (d\mathbf{E}) \end{aligned}$$

where $c_1, c_2, c_3, c_4, c_5, n_1, n_2, n_3$, and a_{ij} are material constants and:

$$\begin{aligned} \|\boldsymbol{\sigma}\| &= (\sigma_{ij}\sigma_{ij})^{\frac{1}{2}} \\ \|\dot{\mathbf{E}}\| &= (\dot{E}_{ij}\dot{E}_{ij})^{\frac{1}{2}} \\ \|\dot{\mathbf{E}}^N\| &= (\dot{E}_{ij}^N\dot{E}_{ij}^N)^{\frac{1}{2}} \end{aligned}$$

In the implementation by Fu Chang the model was simplified such that the input constants a_{ij} and the state variables S_{ij} are scalars.

Additional Remarks:

1. **Bulk Viscosity.** The bulk viscosity, which generates a rate dependent pressure, may cause an unexpected volumetric response. Consequently, it is optional with this model.
2. **Constant Velocity Loading.** Dynamic compression tests at the strain rates of interest in vehicle crash are usually performed with a drop tower. In this test the loading velocity is nearly constant but the true strain rate, which depends on the instantaneous specimen thickness, is not. Therefore, the engineering strain rate input is optional so that the stress-strain curves obtained at constant velocity loading can be used directly. See the SFLAG field.
3. **Strain Rates with Multiaxial Loading.** To further improve the response under multiaxial loading, the strain rate parameter can either be based on the principal strain rates or the volumetric strain rate. See the RFLAG field.
4. **Triaxial Loading.** Correlation under triaxial loading is achieved by directly inputting the results of hydrostatic testing in addition to the uniaxial data. Without this additional information which is fully optional, triaxial response tends to be underestimated. See the PVID field.
5. **Strain Rate Averaging.** Three different options are available. The default, $SRAF = 0.0$, uses a weighted running average with a weight of $1/12$ on the current strain rate. With the second option, $SRAF = 1.0$, the last twelve strain rates are averaged. The third option, $SRAF < 0$, uses an exponential moving average with factor $|SRAF|$ representing the degree of weighting decrease ($-1 \leq SRAF < 0$). The averaged strain rate at time t_n is obtained by:

$$\dot{\epsilon}_n^{\text{averaged}} = |SRAF|\dot{\epsilon}_n + (1 - |SRAF|)\dot{\epsilon}_{n-1}^{\text{averaged}}$$

To suppress time step dependence, you can select a filter window for averaging strain rates. Depending on units and the wanted filter size, you can input either $0.0 < SRAF \leq 0.999$ for which $SRAF$ becomes the filter size or $SRAF \geq 1.0001$ for which $SRAF - 1.0$ becomes the filter size. This rather awkward way of inputting the filter size is for allowing *any* filter size to accurate precision, including a size of 1.0.

6. **Unloading Response Options.** Several options are available to control the unloading response for MAT_083:
 - a) $HU = 0$ and $TBID > 0$. See [Figure M83-2](#).

This is the old way. In this case the unloading response will follow the curve with the lowest strain rate and is rate-independent. The curve with lowest strain rate value (typically zero) in TBID should correspond to the unloading path of the material as measured in a quasistatic test. The

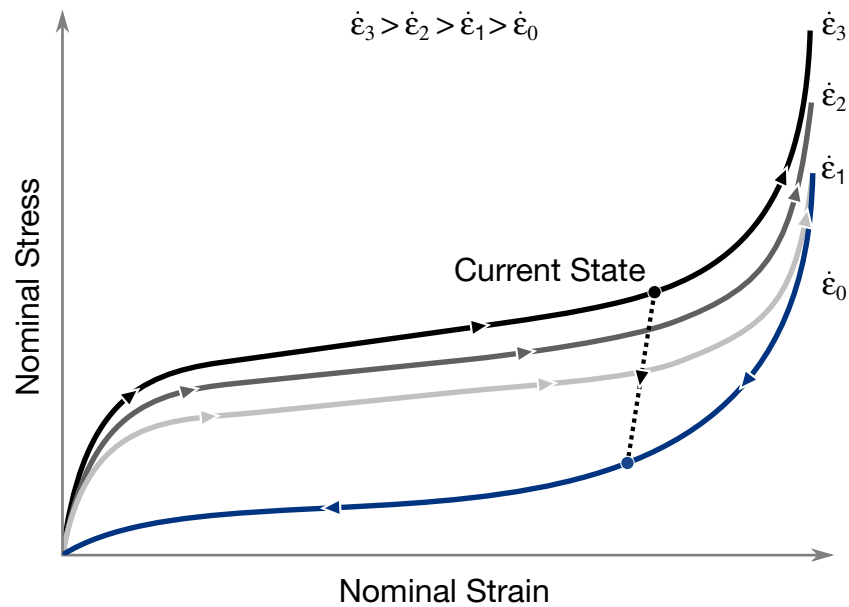

Figure M83-3. $HU = 0$, $TBID < 0$

quasistatic loading path then corresponds to a realistic (small) value of the strain rate.

- b) $HU = 0$ and $TBID < 0$. See [Figure M83-3](#).

In this case the curve with lowest strain rate value (typically zero) in TBID must correspond to the unloading path of the material as measured in a quasistatic test. The quasistatic loading path then corresponds to a realistic (small) value of the strain rate. At least three curves should be used in the table: one for unloading, one for quasistatic, and one or more for dynamic response. The quasistatic loading and unloading path (thus the first two curves of the table) should form a closed loop. The unloading response is given by a damage formulation for the principal stresses as follows:

$$\sigma_i = (1 - d)\sigma_i$$

The damage parameter, d , is computed internally in such a way that the unloading path under uniaxial tension and compression is fitted exactly in the simulation. The unloading response is rate dependent in this case. In some cases, this rate dependence for loading *and* unloading can lead to noisy results. To reduce that noise, it is possible to switch to rate independent unloading with $RIULD = 1$.

- c) $HU > 0$ and $TBID > 0$. See [Figure M83-4](#).

No unloading curve should be provided in the table and the curve with the lowest strain rate value in TBID should correspond to the loading path of the material as measured in a quasistatic test. At least two curves should be used in the table: one for quasistatic and one or more for dynamic

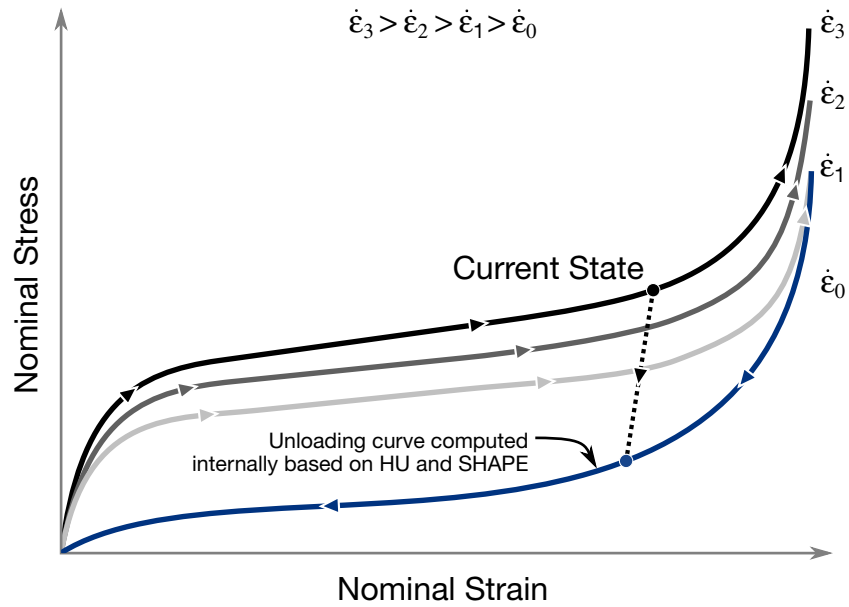

Figure M83-4. HU > 0, TBID > 0

response. In this case the unloading response is given by a damage formulation for the principal stresses as follows:

$$\sigma_i = (1 - d)\sigma_i$$

$$d = (1 - HU) \left[1 - \left(\frac{W_{cur}}{W_{max}} \right)^{SHAPE} \right]^{EXPON}$$

where W_{cur} corresponds to the current value of the hyperelastic energy per unit undeformed volume. The unloading response is rate dependent in this case. In some cases, this rate dependence for loading *and* unloading can lead to noisy results. To reduce that noise, it is possible to switch to rate independent unloading with RIULD = 1.

The LOG_LOG_INTERPOLATION option uses log-log interpolation for table TBID in the strain rate direction.

***MAT_WINFRITH_CONCRETE**

This is Material Type 84 with optional rate effects. The Winfrith concrete model is a smeared crack (sometimes known as pseudo crack), smeared rebar model, implemented in the 8-node single integration point solid element and the 4-node single integration point tetrahedral element, that is, ELFORM = 1 and 10, respectively, in *SECTION_SOLID. We recommend using a double precision executable for simulations that include this material model. Single precision may produce unstable results.

This model was developed by Broadhouse and Neilson [1987] and Broadhouse [1995] over many years and has been validated against experiments. The input documentation given here is taken directly from the report by Broadhouse. The Fortran subroutines and quality assurance test problems were also provided to LSTC by the Winfrith Technology Center.

Rebar may be defined using the command *MAT_WINFRITH_CONCRETE_REINFORCEMENT which appears in the following section.

Card 1	1	2	3	4	5	6	7	8
Variable	MID	RO	TM	PR	UCS	UTS	FE	ASIZE
Type	A	F	F	F	F	F	F	F

Card 2	1	2	3	4	5	6	7	8
Variable	E	YS	EH	UELONG	RATE	CONM	CONL	CONT
Type	F	F	F	F	F	F	F	F

Card 3	1	2	3	4	5	6	7	8
Variable	EPS1	EPS2	EPS3	EPS4	EPS5	EPS6	EPS7	EPS8
Type	F	F	F	F	F	F	F	F

Card 4	1	2	3	4	5	6	7	8
Variable	P1	P2	P3	P4	P5	P6	P7	P8
Type	F	F	F	F	F	F	F	F

VARIABLE**DESCRIPTION**

MID	Material identification. A unique number or label must be specified (see *PART).
RO	Mass density
TM	Initial tangent modulus of concrete
PR	Poisson's ratio
UCS	Uniaxial compressive strength
UTS	Uniaxial tensile strength
FE	Depends on value of RATE below. RATE.EQ.0: fracture energy (energy per unit area dissipated in opening crack) RATE.EQ.1,2: crack width at which crack-normal tensile stress goes to zero
ASIZE	Aggregate size (radius)
E	Young's modulus of rebar
YS	Yield stress of rebar
EH	Hardening modulus of rebar
UELONG	Ultimate elongation before rebar fails.
RATE	Rate effects: EQ.0.0: strain rate effects are included. WARNING: energy may not be conserved using this option. EQ.1.0: strain rate effects are turned off. Crack widths are stored as extra history variables 30, 31, 32.

VARIABLE	DESCRIPTION
CONM	<p>EQ.2.0: like RATE = 1 but includes improved crack algorithm (recommended). Crack widths are stored as extra history variables 3, 4, 5.</p> <p>Units (conversion) flag:</p> <p>GT.0.0: factor to convert model mass units to kg</p> <p>EQ.-1.0: mass, length, time units in model are lbf × sec²/in, inch, sec.</p> <p>EQ.-2.0: mass, length, time units in model are g, cm, microsec.</p> <p>EQ.-3.0: mass, length, time units in model are g, mm, msec.</p> <p>EQ.-4.0: mass, length, time units in model are metric ton, mm, sec.</p> <p>EQ.-5.0: mass, length, time units in model are kg, mm, msec.</p>
CONL	<p>Length units conversion factor:</p> <p>CONM.GT.0: CONL is the conversion factor from model length units to meters.</p> <p>CONM.LE.0: CONL is ignored.</p>
CONT	<p>Time units conversion factor:</p> <p>CONM.GT.0: CONT is the conversion factor from time units to seconds</p> <p>CONM.LE.0: CONT is ignored.</p>
EPS1, EP-S2, ...	<p>Volumetric strain values (natural logarithmic values); see Remarks below. A maximum of 8 values are allowed.</p>
P1, P2, ...	<p>Pressures corresponding to volumetric strain values given on Card 3</p>

Remarks:

Pressure is positive in compression; volumetric strain is given by the natural log of the relative volume and is negative in compression. The tabulated data are given in order of increasing compression, with no initial zero point.

If the volume compaction curve is omitted, the following scaled curve is automatically used where p_1 is the pressure at uniaxial compressive failure from:

$$p_1 = \frac{\sigma_c}{3} ,$$

and K is the bulk unloading modulus computed from

$$K = \frac{E_s}{3(1 - 2\nu)} .$$

Here E_s is the input tangent modulus for concrete and ν is Poisson's ratio.

Volumetric Strain	Pressure
$-p_1/K$	$1.00p_1$
-0.002	$1.50p_1$
-0.004	$3.00p_1$
-0.010	$4.80p_1$
-0.020	$6.00p_1$
-0.030	$7.50p_1$
-0.041	$9.45p_1$
-0.051	$11.55p_1$
-0.062	$14.25p_1$
-0.094	$25.05p_1$

Table M84-1. Default pressure as a function of volumetric strain curve for concrete if the curve is not defined.

The Winfrith concrete model can generate an additional binary output database containing information on crack locations, directions, and widths. In order to generate the crack database, the LS-DYNA execution line is modified by adding:

q=crf

where **crf** is the desired name of the crack database, such as **q=d3crack**.

LS-PrePost can display the cracks on the deformed mesh plots. To do so, read the d3plot database into LS-PrePost and then select *File* → *Open* → *Crack* from the top menu bar. Or, open the crack database by adding the following to the LS-PrePost execution line:

q=crf

where **crf** is the name of the crack database.

By default, all the cracks in visible elements are shown. You can eliminate narrow cracks from the display by setting a minimum crack width for displayed cracks. Do this by choosing *Settings* → *Post Settings* → *Concrete Crack Width*. From the top menu bar of LS-

PrePost, choosing *Misc* → *Model Info* will reveal the number of cracked elements and the maximum crack width in a given plot state.

An ASCII `aea_crack` output file is written if the command `*DATABASE_BINARY_D3CRACK` command is included in the input deck. This command does not have any bearing on the aforementioned binary crack database.

***MAT_WINFRITH_CONCRETE_REINFORCEMENT**

This is *MAT_084_REINF for rebar reinforcement supplemental to concrete defined using Material type 84. Reinforcement may be defined in specific groups of elements, but it is usually more convenient to define a two-dimensional material in a specified layer of a specified part. Reinforcement quantity is defined as the ratio of the cross-sectional area of steel relative to the cross-sectional area of concrete in the element (or layer). These cards may follow either one of two formats below and may also be defined in any order.

Card Summary:

Card 1a. Reinforcement is defined in specific groups of elements.

EID1	EID2	INC	XR	YR	ZR		
------	------	-----	----	----	----	--	--

Card 1b. Reinforcement is defined in two-dimensional layers by part ID. This option is active when the first entry is left blank.

	PID	AXIS	COOR	RQA	RQB		
--	-----	------	------	-----	-----	--	--

Data Card Definitions:

Option 1. Reinforcement quantities in element groups

Card 1a	1	2	3	4	5	6	7	8
Variable	EID1	EID2	INC	XR	YR	ZR		
Type	I	I	I	F	F	F		

VARIABLE**DESCRIPTION**

EID1	First element ID in group
EID2	Last element ID in group
INC	Element increment for generation
XR	<i>x</i> -reinforcement quantity (for bars running parallel to global <i>x</i> -axis)
YR	<i>y</i> -reinforcement quantity (for bars running parallel to global <i>y</i> -axis)
ZR	<i>z</i> -reinforcement quantity (for bars running parallel to global <i>z</i> -axis)

Option 2. Two dimensional layers by part ID. Option 2 is active when first entry is left blank.

Card 1b	1	2	3	4	5	6	7	8
Variable		PID	AXIS	COOR	RQA	RQB		
Type	blank	I	I	F	F	F		

VARIABLE**DESCRIPTION**

PID	Part ID of reinforced elements. If PID = 0, the reinforcement is applied to all parts which use the Winfrith concrete model.
AXIS	Axis normal to layer: EQ.1: A and B are parallel to global y and z , respectively. EQ.2: A and B are parallel to global x and z , respectively. EQ.3: A and B are parallel to global x and y , respectively.
COOR	Coordinate location of layer: AXIS.EQ.1: x -coordinate AXIS.EQ.2: y -coordinate AXIS.EQ.3: z -coordinate
RQA	Reinforcement quantity (A).
RQB	Reinforcement quantity (B).

Remarks:

- Reinforcement Quantity.** Reinforcement quantity is the ratio of area of reinforcement in an element to the element's total cross-sectional area in a given direction. This definition is true for both Options 1 and 2. Where the options differ is in the manner in which it is decided which elements are reinforced. In Option 1, the reinforced element IDs are spelled out. In Option 2, elements of part ID PID which are cut by a plane (layer) defined by AXIS and COOR are reinforced.

***MAT_ORTHOTROPIC_VISCOELASTIC**

This is Material Type 86. It allows for the definition of an orthotropic material with a viscoelastic part. This model applies to shell elements.

NOTE: This material does not support specification of a material angle, β_i , for each through-thickness integration point of a shell.

Card 1	1	2	3	4	5	6	7	8
Variable	MID	RO	EA	EB	EC	VF	K	
Type	A	F	F	F	F	F	F	

Card 2	1	2	3	4	5	6	7	8
Variable	G0	GINF	BETA	PRBA	PRCA	PRCB		
Type	F	F	F	F	F	F		

Card 3	1	2	3	4	5	6	7	8
Variable	GAB	GBC	GCA	AOPT	MANGLE			
Type	F	F	F	F	F			

Card 4	1	2	3	4	5	6	7	8
Variable				A1	A2	A3		
Type				F	F	F		

Card 5	1	2	3	4	5	6	7	8
Variable	V1	V2	V3	D1	D2	D3		
Type	F	F	F	F	F	F		

VARIABLE**DESCRIPTION**

MID	Material identification. A unique number or label must be specified (see *PART).
RO	Mass density
EA	Young's Modulus E_a
EB	Young's Modulus E_b
EC	Young's Modulus E_c
VF	Volume fraction of viscoelastic material
K	Elastic bulk modulus
G0	G_0 , short-time shear modulus
GINF	G_∞ , long-time shear modulus
BETA	β , decay constant
PRBA	Poisson's ratio, ν_{ba}
PRCA	Poisson's ratio, ν_{ca}
PRCB	Poisson's ratio, ν_{cb}
GAB	Shear modulus, G_{ab}
GBC	Shear modulus, G_{bc}
GCA	Shear modulus, G_{ca}
AOPT	Material axes option (see MAT_OPTIONTROPIC_ELASTIC for a more complete description):

VARIABLE	DESCRIPTION
	EQ.0.0: Locally orthotropic with material axes determined by element nodes 1, 2, and 4, as with *DEFINE_COORDINATE_NODES, and then rotated about the shell element normal by an angle MANGLE
	EQ.2.0: Globally orthotropic with material axes determined by vectors defined below, as with *DEFINE_COORDINATE_VECTOR
	EQ.3.0: Locally orthotropic material axes determined by rotating the material axes about the element normal by an angle, MANGLE, from a line in the plane of the element defined by the cross product of the vector \mathbf{v} with the element normal
	LT.0.0: The absolute value of AOPT is a coordinate system ID number (CID on *DEFINE_COORDINATE_NODES, *DEFINE_COORDINATE_SYSTEM or *DEFINE_COORDINATE_VECTOR). Available in R3 version of 971 and later.
MANGLE	Material angle in degrees for AOPT = 0 and 3, may be overridden on the element card; see *ELEMENT_SHELL_BETA.
A1 A2 A3	Define components of vector \mathbf{a} for AOPT = 2
V1 V2 V3	Define components of vector \mathbf{v} for AOPT = 3
D1 D2 D3	Define components of vector \mathbf{d} for AOPT = 2

Remarks:

See material types 2 and 24 for the orthotropic definition.

*MAT_CELLULAR_RUBBER

This is Material Type 87. This material model provides a cellular rubber model with confined air pressure combined with linear viscoelasticity as outlined by Christensen [1980]. See [Figure M87-1](#).

Card Summary:

Card 1. This card is required.

MID	RO	PR	N				
-----	----	----	---	--	--	--	--

Card 2a. This card is included if and only if $N > 0$.

SGL	SW	ST	LCID				
-----	----	----	------	--	--	--	--

Card 2b. This card is included if and only if $N = 0$.

C10	C01	C11	C20	C02			
-----	-----	-----	-----	-----	--	--	--

Card 3. This card is required.

P0	PHI	IVS	G	BETA			
----	-----	-----	---	------	--	--	--

Data Card Definitions:

Card 1	1	2	3	4	5	6	7	8
Variable	MID	RO	PR	N				
Type	A	F	F	I				

VARIABLE

DESCRIPTION

MID	Material identification. A unique number or label must be specified (see *PART).
RO	Mass density
PR	Poisson’s ratio; typical values are between 0.0 to 0.2. Due to the large compressibility of air, large values of Poisson’s ratio generate physically meaningless results.

VARIABLE	DESCRIPTION
N	Order of fit for material model (currently < 3). If $N > 0$, then a least square fit is computed with uniaxial data. The parameters given on Card 2a should be specified. Also see *MAT_MOONEY_RIVLIN_RUBBER (material model 27). A Poisson's ratio of .5 is assumed for the void free rubber during the fit. The Poisson's ratio defined on Card 1 is for the cellular rubber. A void fraction formulation is used.

Material Least Squares Fit Card. Card 2 if $N > 0$, a least squares fit is computed from uniaxial data

Card 2a	1	2	3	4	5	6	7	8
Variable	SGL	SW	ST	LCID				
Type	F	F	F	F				

VARIABLE	DESCRIPTION
SGL	Specimen gauge length, l_0
SW	Specimen width
ST	Specimen thickness
LCID	Load curve ID giving the force as a function of actual change in the gauge length, ΔL . If SGL, SW, and ST are set to unity (1.0), then curve LCID is also engineering stress as a function of engineering strain.

Material Constants Card. Card 2 if $N = 0$, define the following constants

Card 2b	1	2	3	4	5	6	7	8
Variable	C10	C01	C11	C20	C02			
Type	F	F	F	F	F			

VARIABLE	DESCRIPTION
C10	Coefficient, C_{10}

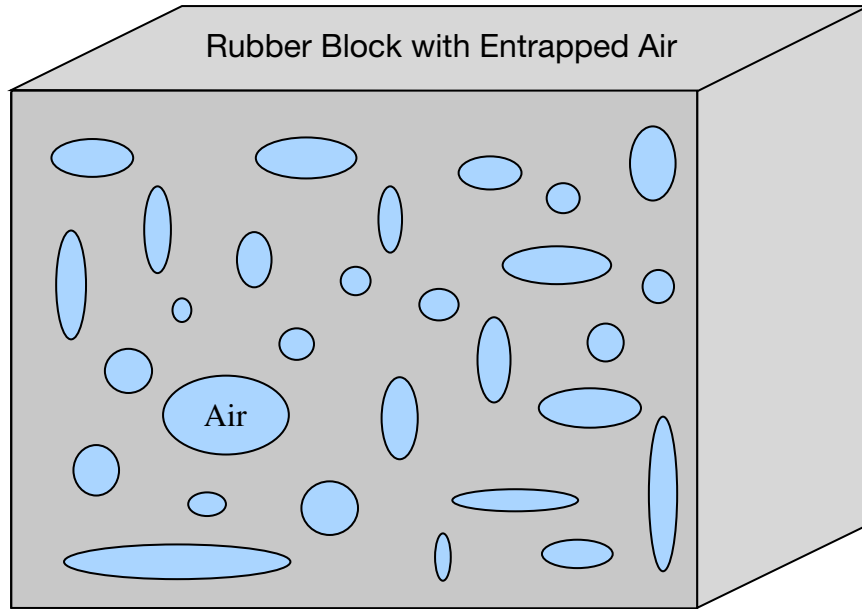

Figure M87-1. Cellular rubber with entrapped air. By setting the initial air pressure to zero, an open cell, cellular rubber can be simulated.

VARIABLE	DESCRIPTION
C01	Coefficient, C_{01}
C11	Coefficient, C_{11}
C20	Coefficient, C_{20}
C02	Coefficient, C_{02}

Card 3	1	2	3	4	5	6	7	8
Variable	P0	PHI	IVS	G	BETA			
Type	F	F	F	F	F			

VARIABLE	DESCRIPTION
P0	Initial air pressure, p_0
PHI	Ratio of cellular rubber to rubber density, ϕ
IVS	Initial volumetric strain, γ_0
G	Optional shear relaxation modulus, G , for rate effects (viscosity)

VARIABLE	DESCRIPTION
BETA	Optional decay constant, β_1

Remarks:

Rubber is generally considered to be fully incompressible since the bulk modulus greatly exceeds the shear modulus in magnitude. To model the rubber as an unconstrained material a hydrostatic work term, $W_H(J)$, is included in the strain energy functional which is function of the relative volume, J , [Ogden 1984]:

$$W(J_1, J_2, J) = \sum_{p,q=0}^n C_{pq} (J_1 - 3)^p (J_2 - 3)^q + W_H(J)$$

$$J_1 + I_1 I_3^{-1/3}$$

$$J_2 + I_2 I_3^{-2/3}$$

In order to prevent volumetric work from contributing to the hydrostatic work the first and second invariants are modified as shown. This procedure is described in more detail by Sussman and Bathe [1987].

The effects of confined air pressure in its overall response characteristics is included by augmenting the stress state within the element by the air pressure, that is,

$$\sigma_{ij} = \sigma_{ij}^{sk} - \delta_{ij} \sigma^{air} ,$$

where σ_{ij}^{sk} is the bulk skeletal stress and σ^{air} is the air pressure. σ^{air} is computed from:

$$\sigma^{air} = - \frac{p_0 \gamma}{1 + \gamma - \phi} ,$$

where p_0 is the initial foam pressure usually taken as the atmospheric pressure and γ defines the volumetric strain. The volumetric is found with

$$\gamma = V - 1 + \gamma_0 ,$$

where V is the relative volume of the voids and γ_0 is the initial volumetric strain which is typically zero. The rubber skeletal material is assumed to be incompressible.

Rate effects are taken into account through linear viscoelasticity by a convolution integral of the form:

$$\sigma_{ij} = \int_0^t g_{ijkl}(t - \tau) \frac{\partial \varepsilon_{kl}}{\partial \tau} d\tau ,$$

or in terms of the second Piola-Kirchhoff stress, S_{ij} , and Green's strain tensor, E_{ij} ,

$$S_{ij} = \int_0^t G_{ijkl}(t - \tau) \frac{\partial \varepsilon_{kl}}{\partial \tau} d\tau ,$$

where $g_{ijkl}(t - \tau)$ and $G_{ijkl}(t - \tau)$ are the relaxation functions for the different stress measures. This stress is added to the stress tensor determined from the strain energy functional.

Since we wish to include only simple rate effects, the relaxation function is represented by one term from the Prony series:

$$g(t) = \alpha_0 + \sum_{m=1}^N \alpha_m e^{-\beta_m t}$$

given by,

$$g(t) = E_d e^{-\beta_1 t}.$$

This model is effectively a Maxwell fluid which consists of a damper and spring in series. We characterize this in the input by a shear modulus, G , and decay constant, β_1 .

The Mooney-Rivlin rubber model (model 27) is obtained by specifying $N = 1$ without air pressure and viscosity. In spite of the differences in formulations with Model 27, we find that the results obtained with this model are nearly identical with those of material type 27 as long as large values of Poisson's ratio are used.

***MAT_MTS**

This is Material Type 88. The MTS model is due to Mauldin, Davidson, and Henninger [1990] and is available for applications involving large strains, high pressures and strain rates. As described in the foregoing reference, this model is based on dislocation mechanics and provides a better understanding of the plastic deformation process for ductile materials by using an internal state variable call the mechanical threshold stress. This kinematic quantity tracks the evolution of the material’s microstructure along some arbitrary strain, strain rate, and temperature-dependent path using a differential form that balances dislocation generation and recovery processes. Given a value for the mechanical threshold stress, the flow stress is determined using either a thermal-activation-controlled or a drag-controlled kinetics relationship. An equation-of-state is required for solid elements and a bulk modulus must be defined below for shell elements.

Card Summary:

Card 1. This card is required.

MID	RO	SIGA	SIGI	SIGS	SIGO	BULK	
-----	----	------	------	------	------	------	--

Card 2. This card is required.

HF0	HF1	HF2	SIGS0	EDOTS0	BURG	CAPA	BOLTZ
-----	-----	-----	-------	--------	------	------	-------

Card 3. This card is required.

SM0	SM1	SM2	EDOT0	GO	PINV	QINV	EDOTI
-----	-----	-----	-------	----	------	------	-------

Card 4. This card is required.

GOI	PINVI	QINVI	EDOTS	GOS	PINVS	QINVS	
-----	-------	-------	-------	-----	-------	-------	--

Card 5. This card is required.

RHOCPR	TEMPRF	ALPHA	EPS0				
--------	--------	-------	------	--	--	--	--

Data Card Definitions:

Card 1	1	2	3	4	5	6	7	8
Variable	MID	RO	SIGA	SIGI	SIGS	SIGO	BULK	
Type	A	F	F	F	F	F	F	

VARIABLE	DESCRIPTION
MID	Material identification. A unique number or label must be specified (see *PART).
RO	Mass density
SIGA	$\hat{\sigma}_a$, dislocation interactions with long-range barriers (force/area)
SIGI	$\hat{\sigma}_i$, dislocation interactions with interstitial atoms (force/area)
SIGS	$\hat{\sigma}_s$, dislocation interactions with solute atoms (force/area)
SIG0	$\hat{\sigma}_0$, initial value of $\hat{\sigma}$ at zero plastic strain (force/area) NOT USED.
BULK	Bulk modulus defined for shell elements only. Do not input for solid elements.

Card 2	1	2	3	4	5	6	7	8
Variable	HF0	HF1	HF2	SIGS0	EDOTS0	BURG	CAPA	BOLTZ
Type	F	F	F	F	F	F	F	F

VARIABLE	DESCRIPTION
HF0	a_0 , dislocation generation material constant (force/area)
HF1	a_1 , dislocation generation material constant (force/area)
HF2	a_2 , dislocation generation material constant (force/area)
SIGS0	$\hat{\sigma}_{\epsilon_{SO}}$, saturation threshold stress at 0° K (force/area)
EDOTS0	$\dot{\epsilon}_{\epsilon_{SO}}$, reference strain-rate (time ⁻¹).
BURG	Magnitude of Burgers vector (interatomic slip distance)
CAPA	Material constant, A
BOLTZ	Boltzmann's constant, k (energy/degree).

Card 3	1	2	3	4	5	6	7	8
Variable	SM0	SM1	SM2	EDOT0	G0	PINV	QINV	EDOTI
Type	F	F	F	F	F	F	F	F

VARIABLE**DESCRIPTION**

SM0	G_0 , shear modulus at zero degrees Kelvin (force/area)
SM1	b_1 , shear modulus constant (force/area)
SM2	b_2 , shear modulus constant (degree)
EDOT0	$\dot{\epsilon}_0$, reference strain-rate (time ⁻¹)
G0	g_0 , normalized activation energy for a dislocation/dislocation interaction
PINV	$1/p$, material constant
QINV	$1/q$, material constant
EDOTI	$\dot{\epsilon}_{0,i}$, reference strain-rate (time ⁻¹)

Card 4	1	2	3	4	5	6	7	8
Variable	G0I	PINVI	QINVI	EDOTS	GOS	PINVS	QINVS	
Type	F	F	F	F	F	F	F	

VARIABLE**DESCRIPTION**

G0I	$g_{0,i}$, normalized activation energy for a dislocation/interstitial interaction
PINVI	$1/p_i$, material constant
QINVI	$1/q_i$, material constant
EDOTS	$\dot{\epsilon}_{0,s}$, reference strain-rate (time ⁻¹)

VARIABLE	DESCRIPTION
G0S	$g_{0,s}$, normalized activation energy for a dislocation/solute interaction
PINVS	$1/p_{s}$, material constant
QINVS	$1/q_{s}$, material constant

Card 5	1	2	3	4	5	6	7	8
Variable	RHOCPR	TEMPRF	ALPHA	EPSO				
Type	F	F	F	F				

VARIABLE	DESCRIPTION
RHOCPR	ρc_p , product of density and specific heat
TEMPRF	T_{ref} , initial element temperature in degrees K
ALPHA	α , material constant (typical value is between 0 and 2)
EPSO	ε_o , factor to normalize strain rate in the calculation of Θ_o (time ⁻¹)

Remarks:

The flow stress σ is given by:

$$\sigma = \hat{\sigma}_a + \frac{G}{G_0} [s_{\text{th}} \hat{\sigma} + s_{\text{th},i} \hat{\sigma}_i + s_{\text{th},s} \hat{\sigma}_s] .$$

The first product in the equation for σ contains a micro-structure evolution variable, $\hat{\sigma}$, which is multiplied by a constant-structure deformation variable s_{th} : s_{th} . $\hat{\sigma}$ is the *Mechanical Threshold Stress* (MTS) and is a function of absolute temperature, T , and the plastic strain-rates, $\dot{\varepsilon}^p$. The evolution equation for $\hat{\sigma}$ is a differential hardening law representing dislocation-dislocation interactions:

$$\frac{\partial}{\partial \varepsilon^p} \hat{\sigma} \equiv \Theta_o \left[1 - \frac{\tanh\left(\alpha \frac{\hat{\sigma}}{\hat{\sigma}_{\text{ES}}}\right)}{\tanh(\alpha)} \right] .$$

The term $\frac{\partial \hat{\sigma}}{\partial \epsilon^p}$ represents the hardening due to dislocation generation while the stress ratio, $\frac{\hat{\sigma}}{\hat{\sigma}_{\epsilon s}}$, represents softening due to dislocation recovery. The threshold stress at zero strain-hardening, $\hat{\sigma}_{\epsilon s}$, is called the saturation threshold stress. Θ_o is given as:

$$\Theta_o = a_o + a_1 \ln \left(\frac{\dot{\epsilon}^p}{\epsilon_0} \right) + a_2 \sqrt{\frac{\dot{\epsilon}^p}{\epsilon_0}}$$

which contains the material constants, a_o , a_1 , and a_2 . The constant, $\hat{\sigma}_{\epsilon s}$, is given as:

$$\hat{\sigma}_{\epsilon s} = \hat{\sigma}_{\epsilon s o} \left(\frac{\dot{\epsilon}^p}{\dot{\epsilon}_{\epsilon s o}} \right)^{kT/Gb^3A}$$

which contains the input constants: $\hat{\sigma}_{\epsilon s o}$, $\dot{\epsilon}_{\epsilon s o}$, b , A , and k . The shear modulus, G , appearing in these equations is assumed to be a function of temperature and is given by the correlation.

$$G = G_0 - b_1 / (e^{b_2/T} - 1)$$

which contains the constants: G_0 , b_1 , and b_2 . For thermal-activation controlled deformation s_{th} is evaluated using an Arrhenius rate equation of the form:

$$s_{th} = \left\{ 1 - \left[\frac{kT \ln \left(\frac{\dot{\epsilon}_0}{\dot{\epsilon}^p} \right) \right]^{\frac{1}{q}} \right\}^{\frac{1}{p}} .$$

The absolute temperature is given as:

$$T = T_{ref} + \frac{E}{\rho c_p} ,$$

where E is the internal energy density per unit initial volume.

*MAT_PLASTICITY_POLYMER

This is Material Type 89. An elasto-plastic material with an arbitrary stress as a function of strain curve and arbitrary strain rate dependency can be defined. It is intended for applications where the elastic and plastic sections of the response are not as clearly distinguishable as they are for metals. Rate dependency of failure strain is included. Many polymers show a more brittle response at high rates of strain. This material is supported for the commonly used solid, shell, and thick shell elements. 2D plane strain stress, plane strain, and axisymmetric elements are *not* supported.

Card 1	1	2	3	4	5	6	7	8
Variable	MID	R0	E	PR				
Type	A	F	F	F				
Default	none	none	none	none				

Card 2	1	2	3	4	5	6	7	8
Variable	C	P	LCSS	LCSR				
Type	F	F	I	I				
Default	0	0	0	0				

Card 3	1	2	3	4	5	6	7	8
Variable	EFTX	DAMP	RFAC	LCFAIL	NUMINT			
Type	F	F	F	I	F			
Default	0	0	0	0	0			

VARIABLE

DESCRIPTION

MID

Material identification. A unique number or label must be specified (see *PART).

VARIABLE	DESCRIPTION
RO	Mass density
E	Young's modulus
PR	Poisson's ratio
C	Strain rate parameter, <i>C</i> , (Cowper Symonds)
P	Strain rate parameter, <i>P</i> , (Cowper Symonds)
LCSS	<p>Load curve ID or Table ID</p> <p>Load Curve. When LCSS is a load curve ID, it is taken as defining effective stress as a function of total effective strain.</p> <p>Tabular Data. The table ID defines for each strain rate value a load curve ID giving the stress as a function effective strain for that rate.</p> <p>Logarithmically Defined Tables. If the <i>first</i> value in the table is negative, LS-DYNA assumes that all the table values represent the natural logarithm of a strain rate. Since the tables are internally discretized to equally space the table values, it makes good sense from an accuracy standpoint that the table values represent the natural log of strain rate when the lowest strain rate and highest strain rate differ by several orders of magnitude.</p>
LCSR	Load curve ID defining strain rate scaling effect on yield stress. If LCSR is negative, the load curve is evaluated using a binary search for the correct interval for the strain rate. The binary search is slower than the default incremental search, but in cases where large changes in the strain rate may occur over a single time step, it is more robust.
EFTX	<p>Failure flag:</p> <p>EQ.0.0: Failure determined by maximum tensile strain (default).</p> <p>EQ.1.0: Failure determined only by tensile strain in local <i>x</i> direction.</p> <p>EQ.2.0: Failure determined only by tensile strain in local <i>y</i> direction.</p>
DAMP	Stiffness-proportional damping ratio. Typical values are 10^{-3} or 10^{-4} . If set too high, instabilities can result.
RFAC	Filtering factor for strain rate effects. Must be between 0 (no filtering) and 1 (infinite filtering). The filter is a simple low pass filter to

VARIABLE	DESCRIPTION
	remove high frequency oscillation from the strain rates before they are used in rate effect calculations. The cut off frequency of the filter is $[(1 - \text{RFAC}) / \text{timestep}]$ rad/sec.
LCFAIL	Load curve ID giving variation of failure strain with strain rate. The points on the x -axis should be natural log of strain rate, while the y -axis should be the true strain to failure. Typically, this is measured by a uniaxial tensile test, and the strain values are converted to true strain.
NUMINT	Number of integration points which must fail before the element is deleted. This option is available for shells only. LT.0.0: $ \text{NUMINT} $ is percentage of integration points/layers which must fail before shell element fails.

Remarks:

- *MAT_089 Compared to *MAT_024.** *MAT_089 is the same as *MAT_024 except for the following points:
 - Load curve lookup for yield stress is based on equivalent uniaxial strain, not plastic strain (see [Remarks 2](#) and [3](#)).
 - Elastic stiffness is initially equal to E but will be increased according to the slope of the stress-strain curve (see [Remark 7](#)).
 - Special strain calculation is used for failure and damage (see [Remark 2](#)).
 - Failure strain depends on strain rate (see [Remark 4](#)).
- Strain Calculation for Failure and Damage.** The strain used for failure and damage calculation, ϵ_{pm} , is based on an approximation of the greatest value of maximum principal strain encountered during the analysis:

$$\epsilon_{\text{pm}} = \max_{i \leq n} (\epsilon_H^i + \epsilon_{\text{vm}}^i) ,$$

where

n = current time step index
 $\max_{i \leq n}(\dots)$ = maximum value attained by the argument during the calculation

$$\epsilon_H = \frac{\epsilon_x + \epsilon_y + \epsilon_z}{3}$$

$\epsilon_x, \epsilon_y, \epsilon_z$ = cumulative strain in the local $x, y,$ or z direction

$$\epsilon_{\text{vm}} = \sqrt{\frac{2}{3} \text{tr}(\boldsymbol{\epsilon}'^T \boldsymbol{\epsilon}')}, \text{ the usual definition of equivalent uniaxial strain}$$

ϵ' = deviatoric strain tensor, where each ϵ_x , ϵ_y , and ϵ_z is cumulative

- Yield Stress Load Curves.** When looking up yield stress from the load curve LCSS, the x -axis value is ϵ_{vm} .

- Failure Strain Load Curves.**

$$\epsilon_{sr} = \frac{d\epsilon_{pm}}{dt} = \text{strain rate for failure and damage calculation}$$

$$\epsilon_F = \text{LCFAIL}(\epsilon_{sr})$$

= Instantaneous true strain to failure from look-up on the curve LCFAIL

- Damage.** A damage approach is used to avoid sudden shocks when the failure strain is reached. Damage begins when the "strain ratio," R , reaches 1.0, where

$$R = \int \frac{d\epsilon_{pm}}{\epsilon_F}$$

Damage is complete, and the element fails and is deleted, when $R = 1.1$. The damage,

$$D = \begin{cases} 1.0 & R < 1.0 \\ 10(1.1 - R) & 1.0 < R < 1.1 \end{cases}$$

is a reduction factor applied to all stresses. For example, when $R = 1.05$, then $D = 0.5$.

- Strain Definitions.** Unlike other LS-DYNA material models, both the input stress-strain curve and the strain to failure are defined as total true strain, not plastic strain. The input can be defined from uniaxial tensile tests; nominal stress and nominal strain from the tests must be converted to true stress and true strain. The elastic component of strain must not be subtracted out.

- Elastic Stiffness Scaling.** The stress-strain curve is permitted to have sections steeper (i.e. stiffer) than the elastic modulus. When these are encountered the elastic modulus is increased to prevent spurious energy generation. The elastic stiffness is scaled by a factor f_e , which is calculated as follows:

$$f_e = \max\left(1.0, \frac{S_{max}}{3G}\right)$$

where

G = initial shear modulus

S_{max} = maximum slope of stress-strain curve encountered during the analysis

- Precision.** Double precision is recommended when using this material model, especially if the strains become high.

- Shell Numbering.** Invariant shell numbering is recommended when using this material model. See *CONTROL_ACCURACY.

*MAT_ACOUSTIC

This is Material Type 90. It specifies the material properties of a linear acoustic fluid. This fluid is assumed to be compressible, irrotational, inviscid, and subject to small displacements. This material is intended for general acoustic applications in either the time domain or frequency domain. See Appendix W for a description of applications. Depending on the application, it can be used with the implicit or explicit solvers.

This model is appropriate for tracking low pressure stress waves in an acoustic media, such as air or water, and can be used only with the acoustic pressure element formulation. The acoustic pressure element requires only one unknown per node. This element is very cost effective. Optionally, cavitation can be allowed.

Card 1	1	2	3	4	5	6	7	8
Variable	MID	RO	C	BETA	CF	ATMOS	GRAV	
Type	A	F	F	F	F	F	F	

Card 2	1	2	3	4	5	6	7	8
Variable	XP	YP	ZP	XN	YN	ZN		
Type	F	F	F	F	F	F		

VARIABLE

DESCRIPTION

MID	Material identification. A unique number or label must be specified (see*PART).
RO	Mass density
C	Sound speed
BETA	Damping factor. Recommended values are between 0.1 and 1.0.
CF	Cavitation flag: EQ.0.0: Off EQ.1.0: On
ATMOS	Atmospheric pressure (optional)

VARIABLE	DESCRIPTION
GRAV	Gravitational acceleration constant (optional)
XP	<i>x</i> -coordinate of free surface point
YP	<i>y</i> -coordinate of free surface point
ZP	<i>z</i> -coordinate of free surface point
XN	<i>x</i> -direction cosine of free surface normal vector
YN	<i>y</i> -direction cosine of free surface normal vector
ZN	<i>z</i> -direction cosine of free surface normal vector

***MAT_ACOUSTIC_COMPLEX**

This is Material Type 90_COMPLEX. It specifies the material properties of a linear acoustic fluid. This fluid is assumed to be compressible, irrotational, inviscid, and subject to small displacements. This material only works with acoustic elements It is intended for direct, steady state vibration simulations with real and imaginary material properties. The model should be used with *CONTROL_IMPLICIT_SSD_DIRECT and thus only works with the implicit solver. See Appendix W for a description of this application.

Card 1	1	2	3	4	5	6	7	8
Variable	MID	RHOR	BULKR	RHOI	BULKI			
Type	A	F	F	F	F			
Default	none	none	none	none	none			

Card 2	1	2	3	4	5	6	7	8
Variable	LCIDRR	LCIDKR	LCIDRI	LCIDKI				
Type	I	I	I	I				
Default	0	0	0	0				
Remarks	2	2	2	2				

VARIABLE

DESCRIPTION

MID	Material identification. A unique number or label must be specified (see*PART).
RHOR	Real part of the density, ρ_r
BULKR	Real part of the bulk modulus, K_r
RHOI	Imaginary part of the density, ρ_i
BULKI	Imaginary part of the bulk modulus, K_i
LCIDRR	Load curve ID for specifying frequency variation of ρ_r .

VARIABLE	DESCRIPTION
LCIDKR	Load curve ID for specifying frequency variation of K_r .
LCIDRI	Load curve ID for specifying frequency variation of ρ_i .
LCIDKI	Load curve ID for specifying frequency variation of K_i .

Remarks:

1. **Mass and Stiffness.** The contributions of elements using this material model are

$$[\bar{M}_f] = \frac{-K_r}{(K_r^2 + K_i^2)} \int_V N_f^T N_f dV + \frac{iK_i}{(K_r^2 + K_i^2)} \int_V N_f^T N_f dV$$

$$[\bar{K}_f] = \frac{-\rho_r}{(\rho_r^2 + \rho_i^2)} \int_V \nabla N_f^T \nabla N_f dV + \frac{i\rho_i}{(\rho_r^2 + \rho_i^2)} \int_V \nabla N_f^T \nabla N_f dV$$

2. **Frequency Dependence.** If the load curve specifying the frequency variation is undefined, then the property is constant with frequency.

***MAT_ACOUSTIC_DAMP**

This is Material Type 90_DAMP. It specifies the material properties of a linear acoustic fluid. This fluid is assumed to be compressible, irrotational, inviscid, and subject to small displacements. This model can only be used with acoustic elements. This material works for explicit transient and direct, steady state vibration applications. See Appendix W for a description of applications. Depending on the application, it can be used with the implicit or explicit solvers.

Card 1	1	2	3	4	5	6	7	8
Variable	MID	RO	CEE	BETA				
Type	A	F	F	F				
Default	none	none	none	0.0				

Card 2	1	2	3	4	5	6	7	8
Variable							VDC	BETA2
Type							F	F
Default							0.0	0.0

VARIABLE**DESCRIPTION**

MID	Material identification. A unique number or label must be specified (see*PART).
RO	Mass density
CEE	Sound speed, c
BETA	Linear bulk viscosity coefficient, β
VDC	Volumetric drag coefficient, r
BETA2	Quadratic bulk viscosity coefficient, β_2

Remarks:

1. **Usage in Direct Steady State Vibration.** The bulk viscosity parameters, BETA and BETA2, are ignored in steady, state vibration simulations invoked with *CONTROL_IMPLICIT_SSD_DIRECT. The volumetric drag coefficient, r , contributes to the fluid damping matrix:

$$[W_f] = \frac{-r}{\rho^2 c^2} \int_V N_f^T N_f dV .$$

r has dimensions of force / volume / velocity.

2. **Usage in Explicit Transient Analysis.** For spectral analyses (see *CONTROL_ACOUSTIC_SPECTRAL), the bulk viscosity parameters, BETA and BETA2, contribute an artificial pressure:

$$\Delta p = \beta \Delta t \dot{p} + \beta_2 \frac{\Delta t^2}{\rho c^2} \dot{p} \max(\dot{p}, 0) .$$

Nonzero values of BETA and BETA2 will adversely affect the time step.

***MAT_ACOUSTIC_POROUS_DB**

This is Material Type 90_POROUS_DB. It specifies the material properties of a linear acoustic fluid. This fluid is assumed to be compressible, irrotational, inviscid, and subject to small displacements. This material works with acoustic elements. It is intended for direct, steady state forced vibration of porous materials having a rigid frame, such as glass wool. It should be used with *CONTROL_IMPLICIT_SSD_DIRECT and thus can only be used with the implicit solver. See Appendix W for a description of applications.

Card 1	1	2	3	4	5	6	7	8
Variable	MID	RH00	CEE0	SIGMA				
Type	A	F	F	F				
Default	none	none	none	none				

Card 2	1	2	3	4	5	6	7	8
Variable	C1	C2	C3	C4	C5	C6	C7	C8
Type	F	F	F	F	F	F	F	F
Default	none	none	none	none	none	none	none	none

VARIABLE**DESCRIPTION**

MID	Material identification. A unique number or label must be specified (see*PART).
RH00	Mass density in air, ρ_0
CEE0	Sound speed in air, c_0
SIGMA	Flow resistivity, σ
C_i	Constants of the material model. See Remark 2 .

Remarks:

1. **Characteristic Impedance and Propagation Constant.** The characteristic impedance is

$$Z = \rho_o c_o (1 + c_1 X^{c_2} - i c_3 X^{c_4}) ,$$

and the propagation constant is

$$\Gamma = \frac{2\pi f}{c_o} (c_5 X^{c_6} + i(1 + c_7 X^{c_8})) ,$$

where

$$f = \frac{\omega}{2\pi} , \quad X = \frac{\rho_o f}{\sigma} .$$

2. **Delany-Bazley, Miki and Allard-Champoux Models.** C1 to C8 of various regression models for the impedance and propagation constant, including those of Delany-Bazley, Miki, and Allard-Champoux, are listed in the journal Applied Acoustics, Sound absorption of porous materials – Accuracy of prediction methods, Oliva and Hongisto, 74 (2013) 1473-1479.

*MAT_SOFT_TISSUE_{OPTION}

Available options include:

<BLANK>

VISCO

This is Material Type 91 (OPTION = <BLANK>) or Material Type 92 (OPTION = VISCO). This material is a transversely isotropic hyperelastic model for representing biological soft tissues, such as ligaments, tendons, and fascia. The representation provides an isotropic Mooney-Rivlin matrix reinforced by fibers having a strain energy contribution with the qualitative material behavior of collagen. The model has a viscoelasticity option which activates a six-term Prony series kernel for the relaxation function. In this case, the hyperelastic strain energy represents the elastic (long-time) response. See Weiss et al. [1996] and Puso and Weiss [1998] for additional details.

NOTE: This material does not support specification of a material angle, β_i , for each through-thickness integration point of a shell.

Card Summary:

Card 1. This card is required.

MID	RO	C1	C2	C3	C4	C5	
-----	----	----	----	----	----	----	--

Card 2. This card is required.

XK	XLAM	FANG	XLAMO	FAILSF	FAILSM	FAILSHR	
----	------	------	-------	--------	--------	---------	--

Card 3. This card is required.

AOPT	AX	AY	AZ	BX	BY	BZ	
------	----	----	----	----	----	----	--

Card 4. This card is required. For shells, this input does not apply, so it may be included as a blank line.

LA1	LA2	LA3	MACF				
-----	-----	-----	------	--	--	--	--

Card 5. This card is included for the VISCO keyword option.

S1	S2	S3	S4	S5	S6		
----	----	----	----	----	----	--	--

Card 6. This card is included for the VISCO keyword option.

T1	T2	T3	T4	T5	T6		
----	----	----	----	----	----	--	--

Card 1	1	2	3	4	5	6	7	8
Variable	MID	RO	C1	C2	C3	C4	C5	
Type	A	F	F	F	F	F	F	

VARIABLE

DESCRIPTION

MID	Material identification. A unique number or label must be specified (see *PART).
RO	Mass density
C1 - C5	Hyperelastic coefficients (see equations in Material Formulation section below)

Card 2	1	2	3	4	5	6	7	8
Variable	XK	XLAM	FANG	XLAM0	FAILSF	FAILSM	FAILSHR	
Type	F	F	F	F	F	F	F	

VARIABLE

DESCRIPTION

XK	Bulk modulus
XLAM	Stretch ratio at which fibers are straightened
FANG	Angle in degrees of a material rotation about the c-axis, available for AOPT = 0 (shells only) and AOPT = 3 (all element types). This angle may be overridden on the element card; see *ELEMENT_SHELL_BETA and *ELEMENT_SOLID_ORTHO. See Remark 1 .
XLAM0	Initial fiber stretch (optional). See Remark 2 .
FAILSF	Stretch ratio for ligament fibers at failure (applies to shell elements only). If zero, failure is not considered.

VARIABLE	DESCRIPTION
FAILSM	Stretch ratio for surrounding matrix material at failure (applies to shell elements only). If zero, failure is not considered.
FAILSHR	Shear strain at failure at a material point (applies to shell elements only). If zero, failure is not considered. This failure value is independent of FAILSF and FAILSM.

Card 3	1	2	3	4	5	6	7	8
Variable	AOPT	AX	AY	AZ	BX	BY	BZ	
Type	F	F	F	F	F	F	F	

VARIABLE	DESCRIPTION
AOPT	<p>Material axes option (see MAT_OPTIONTROPIC_ELASTIC, particularly the Material Directions section, for details). The fiber direction depends on this coordinate system (see Remark 1).</p> <p>EQ.0.0: Locally orthotropic with material axes determined by element nodes 1, 2, and 4, as with *DEFINE_COORDINATE_NODES. For shells only, the material axes are then rotated about the normal vector to the surface of the shell by the angle FANG on this keyword or BETA on the *ELEMENT_SHELL_{OPTION} input.</p> <p>EQ.1.0: Locally orthotropic with material axes determined by a point, P, in space and the global location of the element center; this is the \mathbf{a}-direction. This option is for solid elements only.</p> <p>EQ.2.0: Globally orthotropic with material axes determined by vectors defined below, as with *DEFINE_COORDINATE_VECTOR</p>

VARIABLE	DESCRIPTION
	<p>EQ.3.0: Locally orthotropic material axes determined by a vector \mathbf{v} and the normal vector to the plane of the element. The plane of a solid element is the midsurface between the inner surface and outer surface defined by the first four nodes and the last four nodes of the connectivity of the element, respectively. Thus, for solid elements, AOPT = 3 is only available for hexahedrons. \mathbf{a} is determined by taking the cross product of \mathbf{v} with the normal vector, \mathbf{b} is determined by taking the cross product of the normal vector with \mathbf{a}, and \mathbf{c} is the normal vector. Then \mathbf{a} and \mathbf{b} are rotated about \mathbf{c} by an angle BETA. BETA may be set in the keyword input for the element or with FANG on this keyword. Note that for solids, the material axes may be switched depending on the choice of MACF. The switch may occur before or after applying the angle rotation depending on the value of MACF.</p>
	<p>EQ.4.0: Locally orthotropic in a cylindrical coordinate system with the material axes determined by a vector \mathbf{v}, and an originating point, P, which define the centerline axis. This option is for solid elements only.</p>
	<p>LT.0.0: The absolute value of AOPT is a coordinate system ID number (CID on *DEFINE_COORDINATE_OPTION).</p>
<p>AX, AY, AZ</p>	<p>Vector components that depend on the value of AOPT:</p> <p>AOPT.LT.0.0: Ignored</p> <p>AOPT.EQ.1.0: Components of point p (XP, YP, ZP)</p> <p>AOPT.EQ.2.0: Components of vector \mathbf{a} (A1, A2, A3)</p> <p>AOPT.GT.2.0: Components of vector \mathbf{v} (V1, V2, V3)</p>
<p>BX, BY, BZ</p>	<p>Vector components that depend on the value of AOPT:</p> <p>AOPT.LE.1.0: Ignored</p> <p>AOPT.EQ.2.0: Components of vector \mathbf{d} (D1, D2, D3)</p> <p>AOPT.EQ.3.0: Ignored</p> <p>AOPT.EQ.4.0: Components of point p (XP, YP, ZP)</p>

Card 4	1	2	3	4	5	6	7	8
Variable	LA1	LA2	LA3	MACF				
Type	F	F	F	I				

VARIABLE

DESCRIPTION

LAX, LAY, LAZ

Local fiber orientation vector (solids only)

MACF

Material axes change flag for solid elements:

EQ.-4: Switch material axes *b* and *c* before BETA or FANG rotation

EQ.-3: Switch material axes *a* and *c* before BETA or FANG rotation

EQ.-2: Switch material axes *a* and *b* before BETA or FANG rotation

EQ.1: No change, default

EQ.2: Switch material axes *a* and *b* after BETA or FANG rotation

EQ.3: Switch material axes *a* and *c* after BETA or FANG rotation

EQ.4: Switch material axes *b* and *c* after BETA or FANG rotation

Figure M2-2 indicates when LS-DYNA applies MACF during the process to obtain the final material axes. The BETA on *ELEMENT_SOLID_{OPTION} if defined is used for the rotation for all AOPT options. If BETA is not used for the element, then a rotation only occurs for AOPT = 3 where FANG is applied.

Prony Series Card 1. Additional card for VISCO keyword option.

Card 5	1	2	3	4	5	6	7	8
Variable	S1	S2	S3	S4	S5	S6		
Type	F	F	F	F	F	F		

Prony Series Card 2. Additional card for VISCO keyword option.

Card 6	1	2	3	4	5	6	7	8
Variable	T1	T2	T3	T4	T5	T6		
Type	F	F	F	F	F	F		

VARIABLE

DESCRIPTION

S1 – S6

Factors in the Prony series (see [Material Formulation](#) and [Remark 3](#))

T1 - T6

Characteristic times for Prony series relaxation kernel (see [Material Formulation](#) and [Remark 3](#))

Material Formulation:

The overall strain energy, W , is "uncoupled" and includes two isotropic deviatoric matrix terms, a fiber term, F , and a bulk term:

$$W = C_1(\tilde{I}_1 - 3) + C_2(\tilde{I}_2 - 3) + F(\lambda) + \frac{1}{2}K[\ln(J)]^2$$

Here, \tilde{I}_1 and \tilde{I}_2 are the deviatoric invariants of the right Cauchy deformation tensor, λ is the deviatoric part of the stretch along the current fiber direction, and $J = \det\mathbf{F}$ is the volume ratio. The material coefficients C_1 and C_2 are the Mooney-Rivlin coefficients, while K is the effective bulk modulus of the material (input parameter XK).

The derivatives of the fiber term F are defined to capture the behavior of crimped collagen. The fibers are assumed to be unable to resist compressive loading - thus the model is isotropic when $\lambda < 1$. An exponential function describes the straightening of the fibers, while a linear function describes the behavior of the fibers once they are straightened past a critical fiber stretch level $\lambda \geq \lambda^*$ (input parameter XLAM):

$$\frac{\partial F}{\partial \lambda} = \begin{cases} 0 & \lambda < 1 \\ \frac{C_3}{\lambda} [\exp(C_4(\lambda - 1)) - 1] & 1 < \lambda < \lambda^* \\ \frac{1}{\lambda} (C_5\lambda + C_6) & \lambda \geq \lambda^* \end{cases}$$

Coefficients C_3 , C_4 , and C_5 must be defined by the user. C_6 is determined by LS-DYNA to ensure stress continuity at $\lambda = \lambda^*$. Sample values for the material coefficients $C_1 - C_5$ and λ^* for ligament tissue can be found in Quapp and Weiss [1998]. The bulk modulus

K should be at least 3 orders of magnitude larger than C_1 to ensure near-incompressible material behavior.

Viscoelasticity is included through a convolution integral representation for the time-dependent second Piola-Kirchhoff stress $\mathbf{S}(\mathbf{C}, t)$:

$$\mathbf{S}(\mathbf{C}, t) = \mathbf{S}^e(\mathbf{C}) + \int_0^t 2G(t-s) \frac{\partial W}{\partial \mathbf{C}(s)} ds$$

Here, \mathbf{S}^e is the elastic part of the second Piola-Kirchhoff stress as derived from the strain energy, and $G(t-s)$ is the reduced relaxation function, represented by a Prony series:

$$G(t) = \sum_{i=1}^6 S_i \exp\left(-\frac{t}{T_i}\right).$$

Puso and Weiss [1998] describe a graphical method to fit the Prony series coefficients to relaxation data that approximates the behavior of the continuous relaxation function proposed by Y-C. Fung, as quasilinear viscoelasticity.

Remarks:

1. **Fiber Direction.** For shell elements, the fiber direction lies in the plane of the element. The fiber direction is along the a -axis material direction. This direction depends on the value of AOPT.

For solids elements, the local coordinate system depends on the value of AOPT. The fiber direction is oriented in the local system using input parameters LAX, LAY, and LAZ. By default, (LAX,LAY,LAZ) = (1,0,0), and the fiber is aligned with the local a -direction.

2. **Initial Fiber Stretch.** An optional initial fiber stretch can be specified using XLAM0. The initial stretch is applied during the first time step. This creates preload in the model as soft tissue contacts, and equilibrium is established. For example, a ligament tissue "uncrimping strain" of 3% can be represented with initial stretch value of 1.03.
3. **Prony Series Input.** If the VISCO keyword option is included, at least one Prony series term (S1, T1) must be defined.

***MAT_ELASTIC_6DOF_SPRING_DISCRETE_BEAM**

This is Material Type 93. This material model is defined for simulating the effects of non-linear elastic and nonlinear viscous beams by using six springs each acting about one of the six local degrees-of-freedom. The input consists of part IDs that reference material type, *MAT_ELASTIC_SPRING_DISCRETE_BEAM (type 74 above). Generally, these referenced parts are used only for the definition of this material model and are not referenced by any elements. The two nodes defining a beam may be coincident to give a zero length beam or offset to give a finite length beam. For finite length discrete beams the absolute value of the variable SCOR in the *SECTION_BEAM input should be set to a value of 2.0, which causes the local r -axis to be aligned along the two nodes of the beam to give physically correct behavior. The distance between the nodes of a beam should not affect the behavior of this material model. A triad is used to orient the beam for the directional springs.

Card 1	1	2	3	4	5	6	7	8
Variable	MID	RO	TPIDR	TPIDS	TPIDT	RPIDR	RPIDS	RPIDT
Type	A	F	I	I	I	I	I	I

VARIABLE**DESCRIPTION**

MID	Material identification. A unique number or label must be specified (see *PART).
RO	Mass density; see also volume in *SECTION_BEAM definition.
TPIDR	Translational motion in the local r -direction is governed by part ID TPIDR. If zero, no force is computed in this direction.
TPIDS	Translational motion in the local s -direction is governed by part ID TPIDS. If zero, no force is computed in this direction.
TPIDT	Translational motion in the local t -direction is governed by part ID TPIDT. If zero, no force is computed in this direction.
RPIDR	Rotational motion about the local r -axis is governed by part ID RPIDR. If zero, no moment is computed about this axis.
RPIDS	Rotational motion about the local s -axis is governed by part ID RPIDS. If zero, no moment is computed about this axis.

VARIABLE

DESCRIPTION

RPIDT

Rotational motion about the local t -axis is governed by part ID RPIDT. If zero, no moment is computed about this axis.

Remarks:

Rotational displacement is measured in radians.

***MAT_INELASTIC_SPRING_DISCRETE_BEAM**

This is Material Type 94. This model permits elastoplastic springs with damping to be represented with a discrete beam element type 6. A yield force as a function deflection curve is used which can vary in tension and compression.

Card 1	1	2	3	4	5	6	7	8
Variable	MID	RO	K	F0	D	CDF	TDF	
Type	A	F	F	F	F	F	F	

Card 2	1	2	3	4	5	6	7	8
Variable	FLCID	HLCID	C1	C2	DLE	GLCID		
Type	F	F	F	F	F	I		

VARIABLE**DESCRIPTION**

MID	Material identification. A unique number or label must be specified (see *PART).
RO	Mass density; see also volume in *SECTION_BEAM definition.
K	Elastic loading/unloading stiffness. This is required input.
F0	Optional initial force. This option is inactive if this material is referenced by a part referenced by material type *MAT_INELASTIC_6DOF_SPRING.
D	Optional viscous damping coefficient.
CDF	Compressive displacement at failure. Input as a positive number. After failure, no forces are carried. This option does not apply to zero length springs. EQ.0.0: inactive.
TDF	Tensile displacement at failure. After failure, no forces are carried. EQ.0.0: inactive.

VARIABLE	DESCRIPTION
FLCID	Load curve ID (see *DEFINE_CURVE) defining the yield force as a function of plastic deflection. If the origin of the curve is at (0,0), the force magnitude is identical in tension and compression, that is, only the sign changes. If not, the yield stress in the compression is used when the spring force is negative. The plastic displacement increases monotonically in this implementation. The load curve is required input.
HLCID	Load curve ID (see *DEFINE_CURVE) defining force as a function of relative velocity (optional). If the origin of the curve is at (0,0), the force magnitude is identical for a given magnitude of the relative velocity, that is, only the sign changes.
C1	Damping coefficient
C2	Damping coefficient
DLE	Factor to scale time units
GLCID	Optional load curve ID (see *DEFINE_CURVE) defining a scale factor as a function of deflection for load curve ID, HLCID. If zero, a scale factor of unity is assumed.

Remarks:

1. **Force.** To determine the force, a trial force is first computed as:

$$F^T = F^n + K \times \Delta L(\Delta t)$$

The yield force is taken from the load curve:

$$F^Y = F_y(\Delta L^{\text{plastic}}) ,$$

where L^{plastic} is the plastic deflection, given by

$$\Delta L^{\text{plastic}} = \frac{F^T - F^Y}{S + K^{\text{max}}} .$$

Here S is the slope of FLCID and K^{max} is the maximum elastic stiffness:

$$K^{\text{max}} = \max(K, 2 \times S^{\text{max}}) .$$

The trial force is, then, checked against the yield force to determine F :

$$F = \begin{cases} F^Y & \text{if } F^T > F^Y \\ F^T & \text{if } F^T \leq F^Y \end{cases}$$

The final force, which includes rate effects and damping, is given by:

$$F^{n+1} = F \times \left[1 + C1 \times \Delta\dot{L} + C2 \times \text{sgn}(\Delta\dot{L}) \ln \left(\max \left\{ 1, \frac{|\Delta\dot{L}|}{DLE} \right\} \right) \right] + D \times \Delta\dot{L} + g(\Delta L)h(\Delta\dot{L}) .$$

2. **Yield Force Curve.** Unless the origin of the curve starts at (0,0), the negative part of the curve is used when the spring force is negative where the negative of the plastic displacement is used to interpolate, F_y . The positive part of the curve is used whenever the force is positive. In these equations, ΔL is the change in length

$$\Delta L = \text{current length} - \text{initial length} .$$

3. **Cross-Sectional Area.** The cross-sectional area is defined on the section card for the discrete beam elements, See *SECTION_BEAM. The square root of this area is used as the contact thickness offset if these elements are included in the contact treatment.

***MAT_INELASTIC_6DOF_SPRING_DISCRETE_BEAM**

This is Material Type 95. This material model is defined for simulating the effects of non-linear inelastic and nonlinear viscous beams by using six springs each acting about one of the six local degrees-of-freedom. The input consists of part IDs that reference material type *MAT_INELASTIC_SPRING_DISCRETE_BEAM above (type 94). Generally, these referenced parts are used only for the definition of this material model and are not referenced by any elements. The two nodes defining a beam may be coincident to give a zero length beam, or offset to give a finite length beam. For finite length discrete beams, the absolute value of the variable SCOR in the *SECTION_BEAM input should be set to a value of 2.0, which causes the local r -axis to be aligned along the two nodes of the beam, to give physically correct behavior. The distance between the nodes of a beam should not affect the behavior of this material model. A triad must be used to orient the beam for zero length beams.

Card 1	1	2	3	4	5	6	7	8
Variable	MID	RO	TPIDR	TPIDS	TPIDT	RPIDR	RPIDS	RPIDT
Type	A	F	I	I	I	I	I	I

VARIABLE**DESCRIPTION**

MID	Material identification. A unique number or label must be specified (see *PART).
RO	Mass density, see also volume in *SECTION_BEAM definition.
TPIDR	Translational motion in the local r -direction is governed by part ID TPIDR. If zero, no force is computed in this direction.
TPIDS	Translational motion in the local s -direction is governed by part ID TPIDS. If zero, no force is computed in this direction.
TPIDT	Translational motion in the local t -direction is governed by part ID TPIDT. If zero, no force is computed in this direction.
RPIDR	Rotational motion about the local r -axis is governed by part ID RPIDR. If zero, no moment is computed about this axis.
RPIDS	Rotational motion about the local s -axis is governed by part ID RPIDS. If zero, no moment is computed about this axis.

VARIABLE**DESCRIPTION**

RPIDT

Rotational motion about the local t -axis is governed by part ID RPIDT. If zero, no moment is computed about this axis.

Remarks:

Rotational displacement is measured in radians.

***MAT_BRITTLE_DAMAGE**

This is Material Type 96. It is an anisotropic brittle damage model designed primarily for concrete though it can be applied to a wide variety of brittle materials.

Card 1	1	2	3	4	5	6	7	8
Variable	MID	RO	E	PR	TLIMIT	SLIMIT	FTOUGH	SRETEN
Type	A	F	F	F	F	F	F	F

Card 2	1	2	3	4	5	6	7	8
Variable	VISC	FRA_RF	E_RF	YS_RF	EH_RF	FS_RF	SIGY	
Type	F	F	F	F	F	F	F	

VARIABLE**DESCRIPTION**

MID	Material identification. A unique number or label must be specified (see *PART).
RO	Mass density
E	Young's modulus, E
PR	Poisson's ratio, ν
TLIMIT	Tensile limit, f_n
SLIMIT	Shear limit, f_s
FTOUGH	Fracture toughness, g_c
SRETEN	Shear retention, β
VISC	Viscosity, η
FRA_RF	Fraction of reinforcement in section
E_RF	Young's modulus of reinforcement
YS_RF	Yield stress of reinforcement

VARIABLE	DESCRIPTION
EH_RF	Hardening modulus of reinforcement
FS_RF	Failure strain (true) of reinforcement
SIGY	Compressive yield stress, σ_y EQ.0: No compressive yield

Remarks:

A full description of the tensile and shear damage parts of this material model is given in Govindjee, Kay and Simo [1994,1995]. This model admits progressive degradation of tensile and shear strengths across smeared cracks that are initiated under tensile loadings. Compressive failure is governed by a simplistic J2 flow correction that can be disabled if not desired. Damage is handled by treating the rank 4 elastic stiffness tensor as an evolving internal variable for the material. Softening induced mesh dependencies are handled by a characteristic length method [Oliver 1989].

Description of properties:

1. E is the Young's modulus of the undamaged material also known as the virgin modulus.
2. ν is the Poisson's ratio of the undamaged material also known as the virgin Poisson's ratio.
3. f_n is the initial principal tensile strength (stress) of the material. Once this stress has been reached at a point in the body a smeared crack is initiated there with a normal that is co-linear with the 1st principal direction. Once initiated, the crack is fixed at that location, though it will convect with the motion of the body. As the loading progresses the allowed tensile traction normal to the crack plane is progressively degraded to a small machine dependent constant.

The degradation is implemented by reducing the material's modulus normal to the smeared crack plane according to a maximum dissipation law that incorporates exponential softening. The restriction on the normal tractions is given by

$$\phi_t = (\mathbf{n} \otimes \mathbf{n}) : \boldsymbol{\sigma} - f_n + (1 - \varepsilon)f_n(1 - \exp[-H\alpha]) \leq 0$$

where \mathbf{n} is the smeared crack normal, ε is the small constant, H is the softening modulus, and α is an internal variable. H is set automatically by the program; see g_c below. α measures the crack field intensity and is output in the equivalent plastic strain field, $\bar{\varepsilon}^p$, in a normalized fashion.

The evolution of α is governed by a maximum dissipation argument. When the normalized value reaches unity, the material's strength has been reduced to 2% of its original value in the normal and parallel directions to the smeared crack. Note that for plotting purposes it is never output greater than 5.

- 4. f_s is the initial shear traction that may be transmitted across a smeared crack plane. The shear traction is limited to be less than or equal to $f_s(1 - \beta)(1 - \exp[-H\alpha])$ through the use of two orthogonal shear damage surfaces. Note that the shear degradation is coupled to the tensile degradation through the internal variable α which measures the intensity of the crack field. β is the shear retention factor defined below. The shear degradation is taken care of by reducing the material's shear stiffness parallel to the smeared crack plane.
- 5. g_c is the fracture toughness of the material. It should be entered as fracture energy per unit area crack advance. Once entered the softening modulus is automatically calculated based on element and crack geometries.
- 6. β is the shear retention factor. As the damage progresses the shear tractions allowed across the smeared crack plane asymptote to the product βf_s .
- 7. η represents the viscosity of the material. Viscous behavior is implemented as a simple Perzyna regularization method which allows for the inclusion of first order rate effects. The use of some viscosity is recommend as it serves as regularizing parameter that increases the stability of calculations.
- 8. σ_y is a uniaxial compressive yield stress. A check on compressive stresses is made using the J2 yield function

$$\mathbf{s} : \mathbf{s} - \sqrt{\frac{2}{3}} \sigma_y \leq 0 ,$$

where \mathbf{s} is the stress deviator. If violated, a J2 return mapping correction is executed. This check is executed (1) when no damage has taken place at an integration point yet; (2) when damage has taken place at a point, but the crack is currently closed; and (3) during active damage after the damage integration (i.e. as an operator split). Note that if the crack is open the plasticity correction is done in the plane-stress subspace of the crack plane.

A variety of experimental data has been replicated using this model from quasi-static to explosive situations. Reasonable properties for a standard grade concrete would be:

Property	Value
E	3.15×10^6 psi

Property	Value
f_n	450 psi
f_s	2100 psi
ν	0.2
g_c	0.8 lbs/in
β	0.03
η	0.0 psi-sec
σ_y	4200 psi

For stability, values of η between 104 to 106 psi/sec are recommended. Our limited experience thus far has shown that many problems require nonzero values of η to run to avoid error terminations.

Various other internal variables such as crack orientations and degraded stiffness tensors are internally calculated but currently not available for output.

***MAT_GENERAL_JOINT_DISCRETE_BEAM**

This is Material Type 97. This model is used to define a general joint constraining any combination of degrees of freedom between two nodes. The nodes may belong to rigid or deformable bodies. In most applications the end nodes of the beam are coincident and the local coordinate system (r, s, t axes) is defined by CID (see *SECTION_BEAM).

Card 1	1	2	3	4	5	6	7	8
Variable	MID	RO	TR	TS	TT	RR	RS	RT
Type	A	F	I	I	I	I	I	I
Remarks	1							

Card 2	1	2	3	4	5	6	7	8
Variable	RPST	RPSR						
Type	F	F						
Remarks	2							

VARIABLE**DESCRIPTION**

MID	Material identification. A unique number or label must be specified (see *PART).
RO	Mass density; see also volume in *SECTION_BEAM definition.
TR	Translational constraint code along the r -axis: EQ.0: Free EQ.1: Constrained
TS	Translational constraint code along the s -axis: EQ.0: Free EQ.1: Constrained

VARIABLE	DESCRIPTION
TT	Translational constraint code along the t -axis: EQ.0: Free EQ.1: Constrained
RR	Rotational constraint code about the r -axis: EQ.0: Free EQ.1: Constrained
RS	Rotational constraint code about the s -axis: EQ.0: Free EQ.1: Constrained
RT	Rotational constraint code about the t -axis: EQ.0: Free EQ.1: Constrained
RPST	Penalty stiffness scale factor for translational constraints
RPSR	Penalty stiffness scale factor for rotational constraints

Remarks:

1. **Inertia and Stability.** For explicit calculations, the additional stiffness due to this joint may require addition mass and inertia for stability. Mass and rotary inertia for this beam element is based on the defined mass density, the volume, and the mass moment of inertia defined in the *SECTION_BEAM input.
2. **Penalty Stiffness.** The penalty stiffness applies to explicit calculations. For implicit calculations, constraint equations are generated and imposed on the system equations; therefore, these constants, RPST and RPSR, are not used.

***MAT_SIMPLIFIED_JOHNSON_COOK_{OPTION}**

Available options include:

<BLANK>

STOCHASTIC

This is Material Type 98 implementing Johnson/Cook strain sensitive plasticity. It is used for problems where the strain rates vary over a large range. In contrast to the full Johnson/Cook model (material type 15) this model introduces the following simplifications:

1. thermal effects and damage are ignored,
2. and the maximum stress is directly limited since thermal softening which is very significant in reducing the yield stress under adiabatic loading is not available.

An iterative plane stress update is used for the shell elements, but due to the simplifications related to thermal softening and damage, this model is 50% faster than the full Johnson/Cook implementation. To compensate for the lack of thermal softening, limiting stress values are introduced to keep the stresses within reasonable limits.

A resultant formulation for the Belytschko-Tsay, the C0 Triangle, and the fully integrated type 16 shell elements is available and can be activated by specifying either zero or one through thickness integration point on the *SECTION_SHELL card. While less accurate than through thickness integration, this formulation runs somewhat faster. Since the stresses are not computed in the resultant formulation, the stresses written to the databases for the resultant elements are set to zero.

This model is also available for the Hughes-Liu beam, the Belytschko-Schwer beam, and for the truss element. For the resultant beam formulation, the rate effects are approximated by the axial rate, since the thickness of the beam about its bending axes is unknown. Because this model is primarily used for structural analysis, the pressure is determined using the linear bulk modulus.

Card 1	1	2	3	4	5	6	7	8
Variable	MID	RO	E	PR	VP			
Type	A	F	F	F	F			
Default	none	none	none	none	0.0			

Card 2	1	2	3	4	5	6	7	8
Variable	A	B	N	C	PSFAIL	SIGMAX	SIGSAT	EPSO
Type	F	F	F	F	F	F	F	F
Default	none	0.0	0.0	0.0	10 ¹⁷	SIGSAT	10 ²⁸	1.0

VARIABLE**DESCRIPTION**

MID	Material identification. A unique number or label must be specified (see *PART).
RO	Mass density
E	Young's modulus
PR	Poisson's ratio
VP	Formulation for rate effects: EQ.0.0: scale yield stress (default) EQ.1.0: viscoplastic formulation This option applies only to the 4-node shell and 8-node thick shell if and only if through thickness integration is used.
A	See Remark 1 .
B	See Remark 1 .
N	See Remark 1 .
C	See Remark 1 .

VARIABLE	DESCRIPTION
PSFAIL	Effective plastic strain at failure. If zero, failure is not considered.
SIGMAX	Maximum stress obtainable from work hardening before rate effects are added (optional). This option is ignored if VP = 1.0
SIGSAT	Saturation stress which limits the maximum value of effective stress which can develop after rate effects are added (optional).
EPS0	Quasi-static threshold strain rate. See description under *MAT_-015.

Remarks:

1. **Flow Stress.** Johnson and Cook express the flow stress as

$$\sigma_y = \left(A + B\bar{\epsilon}^{p^n} \right) (1 + C \ln \dot{\epsilon}^*)$$

where A , B , and C are input constants and $\bar{\epsilon}^p$ is the effective plastic strain. $\dot{\epsilon}^*$ is the normalized effective strain rate:

$$\dot{\epsilon}^* = \frac{\dot{\epsilon}}{\text{EPS0}} .$$

The maximum stress is limited by SIGMAX and SIGSAT by:

$$\sigma_y = \min \left\{ \min \left[A + B\bar{\epsilon}^{p^n}, \text{SIGMAX} \right] (1 + c \ln \dot{\epsilon}^*), \text{SIGSAT} \right\} .$$

Failure occurs when the effective plastic strain exceeds PSFAIL.

2. **Viscoplastic.** If the viscoplastic option is active (VP = 1.0), the parameters SIGMAX and SIGSAT are ignored since these parameters make convergence of the plastic strain iteration loop difficult to achieve. The viscoplastic option replaces the effective strain rate in the forgoing equations by the effective plastic strain rate. Numerical noise is substantially reduced by the viscoplastic formulation.
3. **STOCHASTIC.** The STOCHASTIC option allows spatially varying yield and failure behavior. See *DEFINE_STOCHASTIC_VARIATION for additional information.

***MAT_099 *MAT_SIMPLIFIED_JOHNSON_COOK_ORTHOTROPIC_DAMAGE**

***MAT_SIMPLIFIED_JOHNSON_COOK_ORTHOTROPIC_DAMAGE**

This is Material Type 99. This model, which is implemented with multiple through thickness integration points, is an extension of model 98 to include orthotropic damage as a means of treating failure in aluminum panels. Directional damage begins after a defined failure strain is reached in tension and continues to evolve until a tensile rupture strain is reached in either one of the two orthogonal directions. After rupture is detected at NUMINT integration points, the element is deleted.

Card 1	1	2	3	4	5	6	7	8
Variable	MID	RO	E	PR	VP	EPPFR	LCDM	NUMINT
Type	A	F	F	F	F	F	I	I
Default	none	none	none	none	0.0	10 ¹⁶	optional	{all}

Card 2	1	2	3	4	5	6	7	8
Variable	A	B	N	C	PSFAIL	SIGMAX	SIGSAT	EPS0
Type	F	F	F	F	F	F	F	F
Default	none	0.0	0.0	0.0	10 ¹⁷	SIGSAT	10 ²⁸	1.0

VARIABLE

DESCRIPTION

MID	Material identification. A unique number or label must be specified (see *PART).
RO	Mass density
E	Young's modulus
PR	Poisson's ratio
VP	Formulation for rate effects: EQ.0.0: Scale yield stress (default) EQ.1.0: Viscoplastic formulation

VARIABLE	DESCRIPTION
	This option applies only to the 4-node shell and 8-node thick shell if and only if through thickness integration is used.
EPPFR	Plastic strain at which material ruptures (logarithmic)
LCDM	Load curve ID defining nonlinear damage curve. See Figure M81-2 .
NUMINT	Number of through thickness integration points which must fail before the element is deleted. If zero, all points must fail. The default of all integration points is not recommended since elements undergoing large strain are often not deleted due to nodal fiber rotations which limit 0 strains at active integration points after most points have failed. Better results are obtained if NUMINT is set to 1 or a number less than one half of the number of through thickness points. For example, if four through thickness points are used, NUMINT should not exceed 2, even for fully integrated shells which have 16 integration points.
A	See Remark 1 in *MAT_098.
B	See Remark 1 in *MAT_098.
N	See Remark 1 in *MAT_098.
C	See Remark 1 in *MAT_098.
PSFAIL	Principal plastic strain at failure. If zero, failure is not considered.
SIGMAX	Maximum stress obtainable from work hardening before rate effects are added (optional). This option is ignored if VP = 1.0.
SIGSAT	Saturation stress which limits the maximum value of effective stress which can develop after rate effects are added (optional).
EPS0	Quasi-static threshold strain rate. See description under *MAT_015.

Remarks:

See the description for the SIMPLIFIED_JOHNSON_COOK model above.

***MAT_SPOTWELD_{OPTION1}_{OPTION2}**

This is Material Type 100. The material model applies to beam element type 9 and to solid element type 1. The failure models apply to both beam and solid elements.

In the case of solid elements, if hourglass type 4 is specified then hourglass type 4 will be used; otherwise, hourglass type 6 will be automatically assigned. Hourglass type 6 is preferred.

The beam elements, based on the Hughes-Liu beam formulation, may be placed between any two deformable shell surfaces and tied with constraint contact, ***CONTACT_SPOTWELD**, which eliminates the need to have adjacent nodes at spot weld locations. Beam spot welds may be placed between rigid bodies and rigid/deformable bodies by making the node on one end of the spot weld a rigid body node which can be an extra node for the rigid body; see ***CONSTRAINED_EXTRA_NODES_OPTION**. In the same way rigid bodies may also be tied together with this spot weld option. This weld option should not be used with rigid body switching. The foregoing advice is valid if solid element spot welds are used; however, since the solid elements have just three degrees-of-freedom at each node, ***CONTACT_TIED_SURFACE_TO_SURFACE** must be used instead of ***CONTACT_SPOTWELD**.

In flat topologies the shell elements have an unconstrained drilling degree-of-freedom which prevents torsional forces from being transmitted. If the torsional forces are deemed to be important, brick elements should be used to model the spot welds.

Beam and solid element force resultants for **MAT_SPOTWELD** are written to the spot weld force file, **swforc**, and the file for element stresses and resultants for designated elements, **elout**.

*It is advisable to include all spot welds, which provide the slave nodes, and spot welded materials, which define the master segments, within a single ***CONTACT_SPOTWELD** interface for beam element spot welds or a ***CONTACT_TIED_SURFACE_TO_SURFACE** interface for solid element spot welds. As a constraint method these interfaces are treated independently which can lead to significant problems if such interfaces share common nodal points. An added benefit is that memory usage can be substantially less with a single interface.*

Available options for **OPTION1** include:

<BLANK>

DAMAGE-FAILURE

The **DAMAGE-FAILURE** option causes one additional line to be read with the damage parameter and a flag that determines how failure is computed from the resultants. On this line the parameter, **RS**, if nonzero, invokes damage mechanics combined with the plasticity model to achieve a smooth drop off of the resultant forces prior to the removal

of the spot weld. The parameter OPT determines the method used in computing resultant based failure, which is unrelated to damage.

Available options for OPTION2 include:

<BLANK>

UNIAXIAL

The UNIAXIAL keyword option causes the transverse stresses and transverse strains to be zero for solid spot welds. The older uniaxial method, invoked with E < 0.0 on Card 1, assumed only the transverse stresses are zero. Compared to the older method, the UNIAXIAL keyword option increases the stability of the solver. See Remark 2 for more details.

Card Summary:

Card 1. This card is required.

MID	RO	E	PR	SIGY	EH	DT	TFAIL
-----	----	---	----	------	----	----	-------

Card 2a. This card is included if no keyword option is used (<BLANK>) for OPTION1.

EFAIL	NRR	NRS	NRT	MRR	MSS	MTT	NF
-------	-----	-----	-----	-----	-----	-----	----

Card 2b. This card is included if the DAMAGE-FAILURE keyword option is used and OPT = -2, -1 or 0 on Card 3.

EFAIL	NRR	NRS	NRT	MRR	MSS	MTT	NF
-------	-----	-----	-----	-----	-----	-----	----

Card 2c. This card is included if the DAMAGE-FAILURE keyword option is used and OPT = 1 on Card 3.

EFAIL	SIGAX	SIGTAU					NF
-------	-------	--------	--	--	--	--	----

Card 2d. This card is included if the DAMAGE-FAILURE keyword option is used and OPT = 2, 12, or 22 on Card 3.

EFAIL	USRV1	USRV2	USRV3	USRV4	USRV5	USRV6	NF
-------	-------	-------	-------	-------	-------	-------	----

Card 2e. This card is included if the DAMAGE-FAILURE keyword option is used and OPT = 3 or 4 on Card 3.

EFAIL	ZD	ZT	ZALP1	ZALP2	ZALP3	ZRRAD	NF
-------	----	----	-------	-------	-------	-------	----

Card 2f. This card is included if the DAMAGE-FAILURE keyword option is used and OPT = 5 on Card 3.

EFAIL	ZD	ZT	ZT2				
-------	----	----	-----	--	--	--	--

Card 2g. This card is included if the DAMAGE-FAILURE keyword option is used and OPT = 6, 7, 9, -9 or 10 on Card 3.

EFAIL							NF
-------	--	--	--	--	--	--	----

Card 2h. This card is included if the DAMAGE-FAILURE keyword option is used and OPT = 11 on Card 3.

EFAIL	LCT	LCC					NF
-------	-----	-----	--	--	--	--	----

Card 3. This card is included if the DAMAGE-FAILURE keyword option is used.

RS	OPT	FVAL	TRUE_T	ASFF	BETA		DMGOPT
----	-----	------	--------	------	------	--	--------

Card 3.1. This card is included if the DAMAGE-FAILURE keyword option is used and DMGOPT = -1 on Card 3.

DMGOPT	FMODE	FFCAP	TTOPT				
--------	-------	-------	-------	--	--	--	--

Card 4. This card is included if the DAMAGE-FAILURE keyword option is used and OPT = 12 or 22 on Card 3.

USRV7	USRV8	USRV9	USRV10	USRV11	USRV12	USRV13	USRV14
-------	-------	-------	--------	--------	--------	--------	--------

Card 5. This card is included if the DAMAGE-FAILURE keyword option is used and OPT = 12 or 22 on Card 3.

USRV15	USRV16	USRV17	USRV18	USRV19	USRV20	USRV21	USRV22
--------	--------	--------	--------	--------	--------	--------	--------

Data Card Definitions:

Card 1	1	2	3	4	5	6	7	8
Variable	MID	RO	E	PR	SIGY	EH	DT	TFAIL
Type	A	F	F	F	F	F	F	F

VARIABLE	DESCRIPTION
MID	Material identification. A unique number or label must be specified (see *PART).
RO	Mass density
E	Young's modulus. LT.0.0: E is the Young's modulus. $E < 0$ invokes uniaxial stress for solid spot welds with the transverse stresses assumed to be zero. See Remark 2 . This is for when OPTION2 is unset (<BLANK>) only.
PR	Poisson's ratio
SIGY	Yield Stress: GT.0: Initial yield stress EQ.0: Default to 1% of E LT.0: A yield curve or table is assigned by SIGY ; see Remark 5 .
EH	Plastic hardening modulus, E_h
DT	Time step size for mass scaling, Δt
TFAIL	Failure time if nonzero. If zero, this option is ignored.

Card 2 for No Failure. Additional card when no keyword option is used (<BLANK>).

Card 2a	1	2	3	4	5	6	7	8
Variable	EFAIL	NRR	NRS	NRT	MRR	MSS	MTT	NF
Type	F	F	F	F	F	F	F	F

VARIABLE	DESCRIPTION
EFAIL	Effective plastic strain in weld material at failure. The spot weld element is deleted when the plastic strain at each integration point exceeds EFAIL. If zero, failure due to effective plastic strain is not considered.
NRR	Axial force resultant N_{rrF} at failure. If zero, failure due to this component is not considered.

VARIABLE	DESCRIPTION
	GT.0: Constant value LT.0: NRR is a load curve ID, defining the axial force resultant N_{rr_F} at failure as a function of the effective strain rate.
NRS	Force resultant N_{rs_F} at failure. If zero, failure due to this component is not considered. GT.0: Constant value LT.0: NRS is a load curve ID, defining the force resultant N_{rs_F} at failure as a function of the effective strain rate.
NRT	Force resultant N_{rt_F} at failure. If zero, failure due to this component is not considered. GT.0: Constant value LT.0: NRT is a load curve ID, defining the force resultant N_{rt_F} at failure as a function of the effective strain rate.
MRR	Torsional moment resultant M_{rr_F} at failure. If zero, failure due to this component is not considered. GT.0: Constant value LT.0: MRR is a load curve ID, defining the torsional moment resultant M_{rr_F} at failure as a function of the effective strain rate.
MSS	Moment resultant M_{ss_F} at failure. If zero, failure due to this component is not considered. GT.0: Constant value LT.0: MSS is a load curve ID, defining the moment resultant M_{ss_F} at failure as a function of the effective strain rate.
MTT	Moment resultant M_{tt_F} at failure. If zero, failure due to this component is not considered. GT.0: Constant value LT.0: MTT is a load curve ID, defining the moment resultant M_{tt_F} at failure as a function of the effective strain rate.
NF	Number of force vectors stored for filtering

Card 2 for Resultant Based Failure. Additional card for DAMAGE-FAILURE keyword option with OPT = -2, -1 or 0.

Card 2b	1	2	3	4	5	6	7	8
Variable	EFAIL	NRR	NRS	NRT	MRR	MSS	MTT	NF
Type	F	F	F	F	F	F	F	F

VARIABLE**DESCRIPTION**

EFAIL	Effective plastic strain in weld material at failure. The plastic strain must exceed the rupture strain (RS) at each integration point before deletion occurs. See Card 3.
NRR	Axial force resultant N_{rr_F} at failure. If zero, failure due to this component is not considered. GT.0: Constant value LT.0: NRR is a load curve ID, defining the axial force resultant N_{rr_F} at failure as a function of the effective strain rate.
NRS	Force resultant N_{rs_F} at failure. If zero, failure due to this component is not considered. GT.0: Constant value LT.0: NRS is a load curve ID, defining the force resultant N_{rs_F} at failure as a function of the effective strain rate.
NRT	Force resultant N_{rt_F} at failure. If zero, failure due to this component is not considered. GT.0: Constant value LT.0: NRT is a load curve ID, defining the force resultant N_{rt_F} at failure as a function of the effective strain rate.
MRR	Torsional moment resultant M_{rr_F} at failure. If zero, failure due to this component is not considered. GT.0: Constant value LT.0: MRR is a load curve ID, defining the torsional moment resultant M_{rr_F} at failure as a function of the effective strain rate.

VARIABLE	DESCRIPTION
MSS	Moment resultant M_{ssF} at failure. If zero, failure due to this component is not considered. GT.0: Constant value LT.0: MSS is a load curve ID, defining the moment resultant M_{ssF} at failure as a function of the effective strain rate.
MTT	Moment resultant M_{ttF} at failure. If zero, failure due to this component is not considered. GT.0: Constant value LT.0: MTT is a load curve ID, defining the moment resultant M_{ttF} at failure as a function of the effective strain rate.
NF	Number of force vectors stored for filtering

Card 2 for Stress Based Failure. Additional card for DAMAGE-FAILURE keyword option with OPT = 1.

Card 2c	1	2	3	4	5	6	7	8
Variable	EFAIL	SIGAX	SIGTAU					NF
Type	F	F	F					F

VARIABLE	DESCRIPTION
EFAIL	Effective plastic strain in weld material at failure. The plastic strain must exceed the rupture strain (RS) at each integration point before deletion occurs. See Card 3.
SIGAX	Maximum axial stress σ_{rr}^F at failure. GT.0.0: Constant maximum axial stress at failure EQ.0.0: Failure due to this component is not considered. LT.0.0: SIGAX is a load curve ID defining the maximum axial stress at failure as a function of the effective strain rate.
SIGTAU	Maximum shear stress τ^F at failure. GT.0.0: Constant maximum shear stress at failure

VARIABLE

DESCRIPTION

EQ.0.0: Failure due to this component is not considered.

LT.0.0: |SIGTAU| is a load curve ID defining the maximum shear stress at failure as a function of the effective strain rate.

NF Number of force vectors stored for filtering

Card 2 for User Subroutine Based Failure. Additional card for DAMAGE-FAILURE keyword option with OPT = 2, 12, or 22.

Card 2d	1	2	3	4	5	6	7	8
Variable	EFAIL	USRV1	USRV2	USRV3	USRV4	USRV5	USRV6	NF
Type	F	F	F	F	F	F	F	F

VARIABLE

DESCRIPTION

EFAIL Effective plastic strain in weld material at failure. The plastic strain must exceed the rupture strain (RS) at each integration point before deletion occurs. See Card 3.

USRV_n Failure constants for user failure subroutine, *n* = 1,2,...,6

NF Number of force vectors stored for filtering

Card 2 for Notch Stress Failure. Additional card for DAMAGE-FAILURE keyword option with OPT = 3 or 4.

Card 2e	1	2	3	4	5	6	7	8
Variable	EFAIL	ZD	ZT	ZALP1	ZALP2	ZALP3	ZRRAD	NF
Type	F	F	F	F	F	F	F	F

VARIABLE

DESCRIPTION

EFAIL Effective plastic strain in weld material at failure. The plastic strain must exceed the rupture strain (RS) at each integration point before deletion occurs. See Card 3.

ZD Notch diameter

VARIABLE	DESCRIPTION
ZT	Sheet thickness
ZALP1	Correction factor α_1
ZALP2	Correction factor α_2
ZALP3	Correction factor α_3
ZRRAD	Notch root radius (OPT = 3 only)
NF	Number of force vectors stored for filtering

Card 2 for Structural Stress Failure. Additional card for DAMAGE-FAILURE keyword option with OPT = 5.

Card 2f	1	2	3	4	5	6	7	8
Variable	EFAIL	ZD	ZT	ZT2				
Type	F	F	F	F				

VARIABLE	DESCRIPTION
EFAIL	Effective plastic strain in weld material at failure. The plastic strain must exceed the rupture strain (RS) at each integration point before deletion occurs. See Card 3.
ZD	Notch diameter
ZT	Sheet thickness
ZT2	Second sheet thickness

Card 2 for Stress Based Failure from Resultants/Rate Effects. Additional card for DAMAGE-FAILURE keyword option with OPT = 6, 7, 9, -9 or 10.

Card 2g	1	2	3	4	5	6	7	8
Variable	EFAIL							NF
Type	F							F

<u>VARIABLE</u>	<u>DESCRIPTION</u>
EFAIL	Effective plastic strain in weld material at failure. The plastic strain must exceed the rupture strain (RS) at each integration point before deletion occurs. See Card 3.
NF	Number of force vectors stored for filtering

Card 2 for Resultant Based Failure for Beams depending on Loading Direction.
 Additional card for DAMAGE-FAILURE keyword option with OPT =11.

Card 2h	1	2	3	4	5	6	7	8
Variable	EFAIL	LCT	LCC					NF
Type	F	F	F					F

<u>VARIABLE</u>	<u>DESCRIPTION</u>
EFAIL	Effective plastic strain in weld material at failure. The plastic strain must exceed the rupture strain (RS) at each integration point before deletion occurs. See Card 3.
LCT	Load curve or Table ID. Load curve defines resultant failure force under tension as a function of loading direction (in degree range 0 to 90). Table defines these curves as functions of strain rates. See remarks.
LCC	Load curve or Table ID. Load curve defines resultant failure force under compression as a function of loading direction (in degree range 0 to 90). Table defines these curves as functions of strain rates. See remarks.
NF	Number of force vectors stored for filtering

Additional card for the DAMAGE-FAILURE option.

Card 3	1	2	3	4	5	6	7	8
Variable	RS	OPT	FVAL	TRUE_T	ASFF	BETA		DMGOPT
Type	F	F	F	F	I	F		F

VARIABLE	DESCRIPTION
RS	Rupture strain (or rupture time if DMGOPT = 2 or 12). Define if and only if damage is active.
OPT	Failure option: <ul style="list-style-type: none">EQ.-9: OPT = 9 failure is evaluated and written to the swforc file, but element failure is suppressed.EQ.-2: Same as option -1 but in addition, the peak value of the failure criteria and the time it occurs is stored and is written into the swforc database. This information may be necessary since the instantaneous values written at specified time intervals may miss the peaks. Additional storage is allocated to store this information.EQ.-1: OPT = 0 failure is evaluated and written into the swforc file, but element failure is suppressed.EQ.0: Resultant based failureEQ.1: Stress based failure computed from resultants (Toyota)EQ.2: User subroutine uweldfail to determine failureEQ.3: Notch stress-based failure (beam and hex assembly welds only)EQ.4: Stress intensity factor at failure (beam and hex assembly welds only)EQ.5: Structural stress at failure (beam and hex assembly welds only)EQ.6: Stress based failure computed from resultants (Toyota). In this option a shell strain rate dependent failure model is used (beam and hex assembly welds only). The static failure stresses are defined by part ID using the keyword *DEFINE_SPOTWELD RUPTURE_STRESS.EQ.7: Stress based failure for solid elements (Toyota) with peak stresses computed from resultants, and strength values input for pairs of parts; see *DEFINE_SPOTWELD FAILURE_RESULTANTS. Strain rate effects are optional.EQ.8: Not usedEQ.9: Stress based failure from resultants (Toyota). In this option a shell strain rate dependent failure model is used (beam welds only). The static failure stresses are defined

VARIABLE	DESCRIPTION
	by part ID using the keyword *DEFINE_SPOTWELD_RUPTURE_PARAMETER.
	EQ.10: Stress based failure with rate effects. Failure data is defined by material using the keyword *DEFINE_SPOWELD_FAILURE.
	EQ.11: Resultant based failure (beams only). In this option load curves or tables LCT (tension) and LCC (compression) can be defined as resultant failure force as a function loading direction (curve) or resultant failure force as a function of loading direction for each strain rate (table).
	EQ.12: User subroutine uweldfail12 with 22 material constants to determine damage and failure
	EQ.22: user subroutine uweldfail22 with 22 material constants to determine failure
FVAL	Failure parameter. OPT.EQ.-2: Not used OPT.EQ.-1: Not used OPT.EQ.0: Function ID (*DEFINE_FUNCTION) to define alternative Weld Failure. If this is set, the values given for NRR, NRS, NRT, MRR, MSS and MTT in Card 2 are ignored. See description of Weld Failure for OPT = 0. OPT.EQ.1: Not used OPT.EQ.2: Not used OPT.EQ.3: Notch stress value at failure (σ_{KF}) OPT.EQ.4: Stress intensity factor value at failure (K_{eqF}) OPT.EQ.5: Structural stress value at failure (σ_{sF}) OPT.EQ.6: Number of cycles that failure condition must be met to trigger beam deletion. OPT.EQ.7: Not used OPT.EQ.9: Number of cycles that failure condition must be met to trigger beam deletion. OPT.EQ.10: ID of data defined by *DEFINE_SPOTWELD_FAILURE.

VARIABLE	DESCRIPTION
	OPT.EQ.12: Number of history variables available in user defined failure subroutine, uweldfail12.
TRUE_T	True weld thickness. This optional value is available for solid element failure and is used to reduce the moment contribution to the failure calculation from artificially thick weld elements under shear loading, so shear failure can be modeled more accurately. Note that the behavior of TRUE_T depends on TTOPT. See Remark 8 .
	<div style="border: 1px solid black; padding: 10px;">NOTE: We do not recommend using TRUE_T. Instead, we recommend using TTOPT = 2 and leaving TRUE_T = 0.0. In many cases, TTOPT = 2 does a better job of removing the spurious moments. See Remark 9.</div>
ASFF	Weld assembly simultaneous failure flag: EQ.0: Damaged elements fail individually. EQ.1: Damaged elements fail when first reaches failure criterion.
BETA	Damage model decay rate
DMGOPT	Damage option flag: EQ.-1: Flag to include Card 3.1 for additional damage fields. DMGOPT will be set on Card 3.1. EQ.0: Plastic strain based damage EQ.1: Plastic strain based damage with post damage stress limit EQ.2: Time based damage with post damage stress limit EQ.10: Like DMGOPT = 0, but failure option will initiate damage EQ.11: Like DMGOPT = 1, but failure option will initiate damage EQ.12: Like DMGOPT = 2, but failure option will initiate damage

Damage Option Card. Optional additional card for the DAMAGE-FAILURE option; read only if DMGOPT = -1 on Card 3.

Card 3.1	1	2	3	4	5	6	7	8
Variable	DMGOPT	FMODE	FFCAP	TTOPT				
Type	F	F	F	I				

VARIABLE**DESCRIPTION**

DMGOPT	<p>Damage option flag:</p> <p>EQ.0: Plastic strain based damage</p> <p>EQ.1: Plastic strain based damage with post damage stress limit</p> <p>EQ.2: Time based damage with post damage stress limit</p> <p>EQ.10: Like DMGOPT = 0, but failure option will initiate damage</p> <p>EQ.11: Like DMGOPT = 1, but failure option will initiate damage</p> <p>EQ.12: Like DMGOPT = 2, but failure option will initiate damage</p>
FMODE	<p>Failure surface ratio for damage or failure, for DMGOPT = 10, 11, or 12</p> <p>EQ.0: Damage initiates</p> <p>GT.0: Damage or failure (see Remark 6)</p>
FFCAP	<p>Failure function limit for OPT = 0 or -1 and DMGOPT = 10, 11, or 12</p> <p>EQ.0: Damage initiates</p> <p>GT.0: Damage or failure (see Remark 6)</p>
TTOPT	<p>Options for TRUE_T / weld failure behavior:</p> <p>EQ.0: TRUE_T behavior of version R9 and later (see Remark 8)</p> <p>EQ.1: TRUE_T behavior of version R8 and earlier (see Remark 8)</p> <p>EQ.2: Weld failure is invariant with respect to the node numbering of weld elements. For this case, there is no need for the TRUE_T correction. We recommend using this option with TRUE_T set to 0.0. See Remark 9.</p>

Failure Constants Card. Additional card for OPT = 12 or 22.

Card 4	1	2	3	4	5	6	7	8
Variable	USRV7	USRV8	USRV9	USRV10	USRV11	USRV12	USRV13	USRV14
Type	F	F	F	F	F	F	F	F

Failure Constants Card. Additional card for OPT = 12 or 22.

Card 5	1	2	3	4	5	6	7	8
Variable	USRV15	USRV16	USRV17	USRV18	USRV19	USRV20	USRV21	USRV22
Type	F	F	F	F	F	F	F	F

VARIABLE**DESCRIPTION**

USRV n Failure constants for OPT = 12 or 22 user defined failure, $n = 7, 8, \dots, 22$

Remarks:

1. **Failure Model Overview.** Spot weld material is modeled with isotropic hardening plasticity coupled to failure models. EFAIL specifies a failure strain which fails each integration point in the spot weld independently. The OPT parameter is used to specify a failure criterion that fails the entire weld element when the criterion is met. Alternatively, EFAIL and OPT may be used to initiate damage when the DAMAGE-FAILURE option is active using RS, BETA, and DMGOPT as described below.

Beam spot weld elements can use any OPT value except 7. Brick spot weld elements can use any OPT value except 3, 4, 5, 6, 9, and -9. Hex assembly spot welds can use any OPT value except 9 and -9.

For all OPT failure criteria, if a zero is input for a failure parameter on Card 2, the corresponding term will be omitted from the equation. For example, if for OPT = 0, only N_{rrF} is nonzero, the failure surface is reduced to $|N_{rr}| = N_{rrF}$ (see below).

Similarly, if the failure strain EFAIL is set to zero, the failure strain model is not used. Both EFAIL and OPT failure may be active at the same time.

- 2. Loading Solid Welds Uniaxially.** We have implemented two methods of loading solid and solid weld assemblies uniaxially. The older method is invoked by defining the elastic modulus, E , as a negative number where the absolute value of E is the desired value for E . This uniaxial option causes the two transverse stress terms to be assumed to be zero throughout the calculation. This assumption eliminates parasitic transverse stress that causes slow growth of plastic strain-based damage.

The other method is invoked by setting *OPTION2* to UNIAXIAL. This method is preferred. It causes the two transverse stress terms and the two transverse strains terms to be set to zero. It was added because we found that the older method sometimes induced spurious oscillations in the axial force, leading to premature failure.

The motivation for the uniaxial options can be explained with a weld loaded in tension. Due to Poisson's effect, an element in tension would be expected to contract in the transverse directions. However, because the weld nodes are constrained to the mid-plane of shell elements, such contraction is only possible to the degree that the shell element contracts. In other words, the uniaxial stress state cannot be represented by the weld. For plastic strain-based damage, this effect can be particularly apparent as it causes tensile stress to continue to grow very large as the stress state becomes very nearly triaxial tension. In this stress state, plastic strain grows very slowly so it appears that damage calculation is failing to knock down the stress. By simply assuming that the transverse stresses are zero, the plastic strain grows as expected and damage is much more effective.

- 3. NF.** NF specifies the number of terms used to filter the stresses or resultants used in the OPT failure criterion. NF cannot exceed 30. The default value is set to zero which is generally recommended unless oscillatory resultant forces are observed in the time history databases. Although welds should not oscillate significantly, this option was added for consistency with the other spot weld options. NF affects the storage since it is necessary to store the resultant forces as history variables. The NF parameter is available only for beam element welds.
- 4. Time Scaling.** The inertias of the spot welds are scaled during the first time step so that their stable time step size is Δt . A strong compressive load on the spot weld at a later time may reduce the length of the spot weld so that stable time step size drops below Δt . If the value of Δt is zero, mass scaling is not performed, and the spot welds will probably limit the time step size. Under most circumstances, the inertias of the spot welds are small enough that scaling them will have a negligible effect on the structural response and the use of this option is encouraged.

5. **Yield Curve or Table for SIGY.** When using a yield curve or table for SIGY, a simplified plasticity algorithm is used, assuming a linear behavior within one time increment. Thus, no iterative return mapping has to be performed.
6. **Damage.** When the DAMAGE-FAILURE option is invoked, the constitutive properties for the damaged material are obtained from the undamaged material properties. The amount of damage evolved is represented by the constant, ω , which varies from zero if no damage has occurred to unity for complete rupture. For uniaxial loading, the nominal stress in the damaged material is given by

$$\sigma_{\text{nominal}} = \frac{P}{A}$$

where P is the applied load and A is the surface area. The true stress is given by:

$$\sigma_{\text{true}} = \frac{P}{A - A_{\text{loss}}}$$

where A_{loss} is the void area. The damage variable can then be defined:

$$\omega = \frac{A_{\text{loss}}}{A} ,$$

where

$$0 \leq \omega \leq 1 .$$

In this model, damage is initiated when the effective plastic strain in the weld exceeds the failure strain, EFAIL. If DMGOPT = 10, 11, or 12, damage will initiate when the effective plastic strain exceeds EFAIL, or when the failure criterion is met, whichever occurs first. The failure criterion is specified by the OPT parameter. If the inputted value of EFAIL = 0 and DMGOPT = 10, 11, or 12, then damage will only be initiated if the failure criterion is met. After damage initiates, the damage variable is evaluated by one of two ways:

- a) For DMGOPT = 0, 1, 10, or 11, the damage variable is a function of effective plastic strain in the weld:

$$\varepsilon_{\text{failure}}^p \leq \varepsilon_{\text{eff}}^p \leq \varepsilon_{\text{rupture}}^p \Rightarrow \omega = \frac{\varepsilon_{\text{eff}}^p - \varepsilon_{\text{failure}}^p}{\varepsilon_{\text{rupture}}^p - \varepsilon_{\text{failure}}^p} ,$$

where $\varepsilon_{\text{failure}}^p = \text{EFAIL}$ and $\varepsilon_{\text{rupture}}^p = \text{RS}$. If DMGOPT = 10 or 11, and damage initiates by the failure criterion, then $\varepsilon_{\text{failure}}^p$ is set equal to the effective plastic strain in the weld at the time of damage initiation.

- b) For DMGOPT = 2 or 12, the damage variable is a function of time:

$$t_{\text{failure}} \leq t \leq t_{\text{rupture}} \Rightarrow \omega = \frac{t - t_{\text{failure}}}{t_{\text{rupture}}}$$

where t_{failure} is the time at which damage initiates, and $t_{\text{rupture}} = \text{RS}$. For $\text{DMGOPT} = 2$, t_{failure} is set equal to the time at which ϵ_{eff}^p exceeds EFAIL . For $\text{DMGOPT} = 12$, t_{failure} is set equal to either the time when ϵ_{eff}^p exceeds EFAIL or the time when the failure criterion is met, whichever occurs first.

If $\text{DMGOPT} = 0, 1$, or 2 , inputting $\text{EFAIL} = 0$ will cause damage to initiate as soon as the weld stress reaches the yield surface. Prior to version 9.1, inputting $\text{EFAIL} = 0$ for $\text{DMGOPT} = 10, 11, 12$ would similarly cause damage to initiate when the stress state reaches the yield surface, but version 9.1 and later will ignore $\text{EFAIL} = 0$ and only initiate damage when the failure criterion is met. If the effective plastic strain is zero when damage initiates by the failure criterion, then the yield stress of the weld is reduced to the current effective stress so that the stress state is on the yield surface and plastic strain can start to grow.

For $\text{DMGOPT} = 1$, the damage behavior is the same as for $\text{DMGOPT} = 0$, but an additional damage variable is calculated to prevent stress growth during softening. Similarly, $\text{DMGOPT} = 11$ behaves like $\text{DMGOPT} = 10$ except for the additional damage variable. This additional function is also used with $\text{DMGOPT} = 2$ and 12 . The effect of this additional damage function is noticed only in brick and brick assembly welds in tension loading where it prevents growth of the tensile force in the weld after damage initiates.

For $\text{DMGOPT} = 10, 11$, or 12 an optional FMODE parameter determines whether a weld that reaches the failure surface will fail immediately or initiate damage. The failure surface calculation has shear terms, which may include the torsional moment as well as normal and bending terms. If FMODE is input with a value between 0 and 1 , then when the failure surface is reached, the sum of the square of the shear terms is divided by the sum of the square of all terms. If this ratio exceeds FMODE , then the weld will fail immediately. If the ratio is less than or equal to FMODE , then damage will initiate. The FMODE option is available only for brick and brick assembly welds.

For resultant based failure ($\text{OPT} = -1$ or 0) and $\text{DMGOPT} = 10, 11$, or 12 an optional FFCAP parameter determines whether a weld that reaches the failure surface will fail immediately. After damage initiation, the failure function can reach values above 1.0 . This can now be limited by the FFCAP value (should be larger than 1.0):

$$\left(\left[\frac{\max(N_{rr}, 0)}{N_{rrF}} \right]^2 + \left[\frac{N_{rs}}{N_{rsF}} \right]^2 + \left[\frac{N_{rt}}{N_{rtF}} \right]^2 + \left[\frac{M_{rr}}{M_{rrF}} \right]^2 + \left[\frac{M_{ss}}{M_{ssF}} \right]^2 + \left[\frac{M_{tt}}{M_{ttF}} \right]^2 \right)^{\frac{1}{2}} < \text{FFCAP}$$

7. **BETA.** If BETA is specified, the stress is multiplied by an exponential using ω defined in the equations define in [Remark 6](#),

$$\sigma_d = \sigma \exp(-\beta\omega) .$$

For weld elements in an assembly (see RPBHX on *CONTROL_SPOTWELD_BEAM or *DEFINE_HEX_SPOTWELD_ASSEMBLY), the failure criterion is evaluated using the assembly cross section. If damage is not active, all elements will be deleted when the failure criterion is met. If damage is active, then damage is calculated independently in each element of the assembly. By default, elements of the assembly are deleted as damage in each element is complete. If ASFF = 1, then failure and deletion of all elements in the assembly will occur simultaneously when damage is complete in any one of the elements.

- 8. TRUE_T and TTOPT.** Solid weld elements and weld assemblies are tied to the mid-plane of shell materials and so typically have a thickness that is half the sum of the thicknesses of the welded shell sections. As a result, a weld under shear loading can be subject to an artificially large moment which will be balanced by normal forces transferred through the tied contact. These normal forces will cause the out-of-plane bending moment used in the failure calculation to be artificially high.

TRUE_T was our original implementation to fix this issue. Inputting a TRUE_T value that is smaller than the modeled thickness, for example, 10%-30% of true thickness will scale down the moment or stress that results from the balancing moment and provide more realistic failure calculations for solid elements and weld assemblies. TRUE_T effects only the failure calculation, not the weld element behavior. If TRUE_T = 0.0 or data is omitted, the modeled weld element thickness is used. Our preferred solution to this problem is keeping TRUE_T = 0.0 and setting TTOPT = 2 which is discussed in [Remark 9](#).

The behavior of TRUE_T depends on TTOPT. In LS-DYNA version R9, a modification to the TRUE_T behavior was made to address a condition of weld assemblies that are tied to shell elements of significantly different stiffness. This change had unintended effects on the behavior of weld failure, so TTOPT was added to revert the behavior of TRUE_T to that of R8 and earlier versions. The default behavior of TTOPT is to perform the R9 method but setting TTOPT = 1 will cause the earlier method to be used. TTOPT = 1 also invokes a second correction. With TTOPT = 0, weld assemblies use TRUE_T as if it was a scale factor, but single element welds use it as a thickness value. Setting TTOPT = 1 corrects this so that both weld assemblies and single welds use TRUE_T as a thickness value.

For OPT = 0 (see below), the two out-of-plane moments, M_{ss} and M_{tt} are replaced by modified terms \widehat{M}_{ss} and \widehat{M}_{tt} :

$$\left[\frac{\max(N_{rr}, 0)}{N_{rrF}} \right]^2 + \left[\frac{N_{rs}}{N_{rsF}} \right]^2 + \left[\frac{N_{rt}}{N_{rtF}} \right]^2 + \left[\frac{M_{rr}}{M_{rrF}} \right]^2 + \left[\frac{\widehat{M}_{ss}}{M_{ssF}} \right]^2 + \left[\frac{\widehat{M}_{tt}}{M_{ttF}} \right]^2 - 1 = 0$$

$$\widehat{M}_{ss} = \begin{cases} M_{ss} - N_{rt}t(1 - t_{\text{true}}) & \text{for solid weld assemblies with TTOPT} = 0 \\ M_{ss} - N_{rt}(t - t_{\text{true}}) & \text{otherwise} \end{cases}$$

$$\widehat{M}_{tt} = \begin{cases} M_{tt} - N_{rs}t(1 - t_{\text{true}}) & \text{for solid weld assemblies with TTOPT} = 0 \\ M_{tt} - N_{rs}(t - t_{\text{true}}) & \text{otherwise} \end{cases}$$

In the above, t is the element thickness and t_{true} is the TRUE_T parameter. For OPT = 1 (see below), the same modification is done to the moments that contribute to the normal stress, as shown below:

$$\sigma_{rr} = \frac{N_{rr}}{A} + \frac{\sqrt{\widehat{M}_{ss}^2 + \widehat{M}_{tt}^2}}{Z} .$$

9. **TTOPT = 2.** By default, failure is calculated using forces on the bottom surface of the weld as defined by nodes 1 to 4 of each element. Setting TTOPT = 2 causes the average of the forces on the bottom and top to be used so that failure is invariant. When TTOPT = 2 is used, the averaging causes the spurious moments or peak normal stress to cancel, so there is no need for a TRUE_T correction. Therefore, the best practice is to use TTOPT = 2 and TRUE_T = 0.0.
10. **History Data Output Files.** Spot weld force history data is written into the swforc ASCII file. In this database the resultant moments are not available, but they are in the binary time history database and in the ASCII elout file.
11. **Material Histories.** The probability of failure in solid or beam spotwelds can be estimated by retrieving the corresponding material histories for output to the d3plot database.

<i>*DEFINE_MATERIAL_HISTORIES Properties</i>		
Label	Attributes	Description
Instability	- - - -	A measure between 0 and 1 related to how close the spotweld element is to fail
Damage	- - - -	Damage in the spotweld element between 0 and 1

These two labels are supported for all options (OPT and DMGOPT, including assemblies and beams), except for user defined failure. The instability measure is the maximum over time; namely, it gives the maximum value for a given element throughout the simulation. If a damage option is invoked, then damage will initiate and increment when the instability reaches unity, and elements are not deleted until the damage value reaches unity. If no damage option is

invoked, then the damage output is always zero and elements will be deleted at the point when the instability measure reaches unity

OPT = -1 or 0

OPT = 0 and OPT = -1 invoke a resultant-based failure criterion that fails the weld if the resultants are outside of the failure surface defined by:

$$\left[\frac{\max(N_{rr}, 0)}{N_{rrF}} \right]^2 + \left[\frac{N_{rs}}{N_{rsF}} \right]^2 + \left[\frac{N_{rt}}{N_{rtF}} \right]^2 + \left[\frac{M_{rr}}{M_{rrF}} \right]^2 + \left[\frac{M_{ss}}{M_{ssF}} \right]^2 + \left[\frac{M_{tt}}{M_{ttF}} \right]^2 - 1 = 0$$

where the *numerators* in the equation are the resultants calculated in the local coordinates of the cross section, and the *denominators* are the values specified in the input. If OPT = -1, the failure surface equation is evaluated, but element failure is suppressed. This allows easy identification of vulnerable spot welds when post-processing. Failure is likely to occur if FC > 1.0.

Alternatively, a *DEFINE_FUNCTION could be used to define the Weld Failure for OPT = 0. Then set FVAL = function ID. Such a function could look like this:

```
*DEFINE_FUNCTION
      100
      func (nrr, nrs, nrt, mrr, mss, mtt) = (nrr/5.0) * (nrr/5.0)
```

The six arguments for this function (nrr, ..., mtt) are the force and moment resultants during the computation.

OPT = 1:

OPT = 1 invokes a stress based failure model, which was developed by *Toyota Motor Corporation* and is based on the peak axial and transverse shear stresses. The weld fails if the stresses are outside of the failure surface defined by

$$\left(\frac{\sigma_{rr}}{\sigma_{rr}^F} \right)^2 + \left(\frac{\tau}{\tau^F} \right)^2 - 1 = 0$$

If strain rates are considered, then the failure criteria becomes:

$$\left[\frac{\sigma_{rr}}{\sigma_{rr}^F(\dot{\epsilon}_{\text{eff}})} \right]^2 + \left[\frac{\tau}{\tau^F(\dot{\epsilon}_{\text{eff}})} \right]^2 - 1 = 0$$

where $\sigma_{rr}^F(\dot{\epsilon}_{\text{eff}})$ and $\tau^F(\dot{\epsilon}_{\text{eff}})$ are defined by load curves (SIGAX and SIGTAU are less than zero). The peak stresses are calculated from the resultants using simple beam theory:

$$\sigma_{rr} = \frac{N_{rr}}{A} + \frac{\sqrt{M_{ss}^2 + M_{tt}^2}}{Z}$$

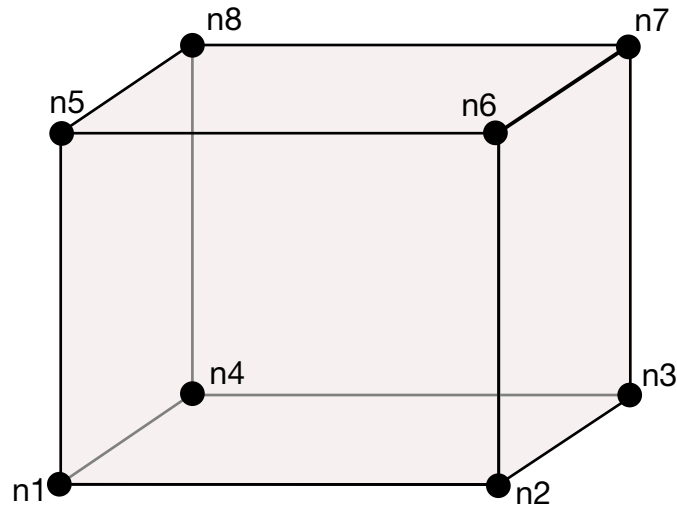

Figure M100-1. A solid element used as spot weld is shown. When resultant based failure is used orientation is very important. Nodes n1 - n4 attach to the lower shell mid-surface and nodes n5 - n8 attach to the upper shell mid-surface. The resultant forces and moments are computed based on the assumption that the brick element is properly oriented.

$$\tau = \frac{M_{rr}}{2Z} + \frac{\sqrt{N_{rs}^2 + N_{rt}^2}}{A}$$

where the area and section modulus are given by:

$$A = \pi \frac{d^2}{4}$$

$$Z = \pi \frac{d^3}{32}$$

In the above equations, d is the equivalent diameter of the beam element or solid element used as a spot weld.

OPT = 2

OPT = 2 invokes a user-written subroutine `uweldfail`, documented in Appendix Q.

OPT = 12 or 22

OPT = 12 and OPT = 22 invoke similar user-written subroutines, `uweldfail12` and `uweldfail22`, respectively. Both allow up to 22 failure parameters to be used rather than the 6 allowed with OPT = 2. OPT = 12 also allows user control of weld damage.

OPT = 3

OPT = 3 invokes a failure based on notch stress, see Zhang [1999]. Failure occurs when the failure criterion:

$$\sigma_k - \sigma_{kF} \geq 0$$

is satisfied. The notch stress is given by the equation:

$$\sigma_k = \alpha_1 \frac{4F}{\pi dt} \left(1 + \frac{\sqrt{3} + \sqrt{19}}{8\sqrt{\pi}} \sqrt{\frac{t}{\rho}} \right) + \alpha_2 \frac{6M}{\pi dt^2} \left(1 + \frac{2}{\sqrt{3\pi}} \sqrt{\frac{t}{\rho}} \right) + \alpha_3 \frac{4F_{rr}}{\pi d^2} \left(1 + \frac{5}{3\sqrt{2\pi}} \frac{d}{t} \sqrt{\frac{t}{\rho}} \right)$$

Here,

$$F = \sqrt{F_{rs}^2 + F_{rt}^2}$$

$$M = \sqrt{M_{ss}^2 + M_{tt}^2}$$

and the α_i ($i = 1, 2, 3$) are input corrections factors with default values of unity. If spot welds are between sheets of unequal thickness, the minimum thickness of the spot welded sheets may be introduced as a crude approximation.

OPT = 4

OPT = 4 invokes failure based on structural stress intensity, see Zhang [1999]. Failure occurs when the failure criterion:

$$K_{eq} - K_{eqF} \geq 0$$

is satisfied where

$$K_{eq} = \sqrt{K_I^2 + K_{II}^2}$$

and

$$K_I = \alpha_1 \frac{\sqrt{3}F}{2\pi d\sqrt{t}} + \alpha_2 \frac{2\sqrt{3}M}{\pi dt\sqrt{t}} + \alpha_3 \frac{5\sqrt{2}F_{rr}}{3\pi d\sqrt{t}}$$

$$K_{II} = \alpha_1 \frac{2F}{\pi d\sqrt{t}}$$

Here, F and M are as defined above for the notch stress formulas and again, α_i ($i = 1, 2, 3$) are input corrections factors with default values of unity. If spot welds are between sheets of unequal thickness, the minimum thickness of the spot welded sheets may be used as a crude approximation.

The maximum structural stress at the spot weld was utilized successfully for predicting the fatigue failure of spot welds, see Rupp, et. al. [1994] and Sheppard [1993]. The corresponding results from] Rupp, et. al. are listed below where it is assumed that they may be suitable for crash conditions.

OPT = 5

OPT = 5 invokes failure by

$$\max(\sigma_{v1}, \sigma_{v2}, \sigma_{v3}) - \sigma_{sF} = 0 ,$$

where σ_{sF} is the critical value of structural stress at failure. It is noted that the forces and moments in the equations below refer to the beam node 1, beam node 2, and the midpoint, respectively. The three stress values, $\sigma_{v1}, \sigma_{v2}, \sigma_{v3}$, are defined by:

$$\sigma_{v1}(\zeta) = \frac{F_{rs1}}{\pi dt_1} \cos\zeta + \frac{F_{rt1}}{\pi dt_1} \sin\zeta - \frac{1.046\beta_1 F_{rr1}}{t_1 \sqrt{t_1}} - \frac{1.123M_{ss1}}{dt_1 \sqrt{t_1}} \sin\zeta + \frac{1.123M_{tt1}}{dt_1 \sqrt{t_1}} \cos\zeta$$

with

$$\beta_1 = \begin{cases} 0 & F_{rr1} \leq 0 \\ 1 & F_{rr1} > 0 \end{cases}$$

$$\sigma_{v2}(\zeta) = \frac{F_{rs2}}{\pi dt_2} \cos\zeta + \frac{F_{rt2}}{\pi dt_2} \sin\zeta - \frac{1.046\beta_1 F_{rr2}}{t_2 \sqrt{t_2}} + \frac{1.123M_{ss2}}{dt_2 \sqrt{t_2}} \sin\zeta - \frac{1.123M_{tt2}}{dt_2 \sqrt{t_2}} \cos\zeta$$

with

$$\beta_2 = \begin{cases} 0 & F_{rr2} \leq 0 \\ 1 & F_{rr2} > 0 \end{cases}$$

$$\sigma_{v3}(\zeta) = 0.5\sigma(\zeta) + 0.5\sigma(\zeta)\cos(2\alpha) + 0.5\tau(\zeta)\sin(2\alpha)$$

where

$$\begin{aligned} \sigma(\zeta) &= \frac{4\beta_3 F_{rr}}{\pi d^2} + \frac{32M_{ss}}{\pi d^3} \sin\zeta - \frac{32M_{tt}}{\pi d^3} \cos\zeta \\ \tau(\zeta) &= \frac{16F_{rs}}{3\pi d^2} \sin^2\zeta + \frac{16F_{rt}}{3\pi d^2} \cos^2\zeta \\ \alpha &= \frac{1}{2} \tan^{-1} \frac{2\tau(\zeta)}{\sigma(\zeta)} \\ \beta_3 &= \begin{cases} 0 & F_{rr} \leq 0 \\ 1 & F_{rr} > 0 \end{cases} \end{aligned}$$

The stresses are calculated for all directions, $0^\circ \leq \zeta \leq 90^\circ$, in order to find the maximum.

OPT = 10

OPT = 10 invokes the failure criterion developed by Lee and Balur (2011). It is available for welds modeled by beam elements, solid elements, or solid assemblies. A detailed discussion of the criterion is given in the user's manual section for *DEFINE_SPOTWELD_FAILURE.

OPT = 11

OPT = 11 invokes a resultant force based failure criterion for beams. With corresponding load curves or tables LCT and LCC, resultant force at failure F_{fail} can be defined as function of loading direction γ (curve) or loading direction γ and effective strain rate $\dot{\epsilon}$ (table):

$$F_{fail} = f(\gamma) \quad \text{or} \quad F_{fail} = f(\gamma, \dot{\epsilon})$$

with the following definitions for loading direction (in degree) and effective strain rate:

$$\gamma = \tan^{-1} \left(\left| \frac{F_{shear}}{F_{axial}} \right| \right), \quad \dot{\epsilon} = \left[\frac{2}{3} (\dot{\epsilon}_{axial}^2 + \dot{\epsilon}_{shear}^2) \right]^{1/2}$$

It depends on the sign of the axial beam force, if LCT or LCC are used for failure condition:

$$\begin{aligned} F_{axial} > 0: & \quad [F_{axial}^2 + F_{shear}^2]^{1/2} > F_{fail,LCT} \rightarrow \text{failure} \\ F_{axial} < 0: & \quad [F_{axial}^2 + F_{shear}^2]^{1/2} > F_{fail,LCC} \rightarrow \text{failure} \end{aligned}$$

*MAT_SPOTWELD_DAIMLERCHRYSLER_{OPTION}

This is Material Type 100. The material model applies only to solid element type 1. If hourglass type 4 is specified, then hourglass type 4 will be used; otherwise, hourglass type 6 will be automatically assigned. Hourglass type 6 is preferred.

Spot weld elements may be placed between any two deformable shell surfaces and tied with constraint contact, *CONTACT_TIED_SURFACE_TO_SURFACE, which eliminates the need to have adjacent nodes at spot weld locations. Spot weld failure is modeled using this card and *DEFINE_CONNECTION_PROPERTIES data. Details of the failure model can be found in Seeger, Feucht, Frank, Haufe, and Keding [2005].

NOTE: It is advisable to include all spot welds, which provide the tracked nodes, and spot welded materials, which define the reference segments, within a single *CONTACT_TIED_SURFACE_TO_SURFACE interface. This contact type uses constraint equations. If multiple interfaces are treated independently, significant problems can occur if such interfaces share common nodes. An added benefit is that memory usage can be substantially less with a single interface.

Available options include:

<BLANK>

UNIAXIAL

The UNIAXIAL keyword option causes the transverse stresses and transverse strains to be zero for solid spot welds. The older uniaxial method, invoked with E < 0.0 on Card 1, assumed only the transverse stresses are zero. Compared to the older method, the UNIAXIAL keyword option increases the stability of the solver. See Remark 1 for more details.

Card 1	1	2	3	4	5	6	7	8
Variable	MID	RO	E	PR			DT	TFAIL
Type	A	F	F	F			F	F

Card 2	1	2	3	4	5	6	7	8
Variable	EFAIL							NF
Type	F							F

Card 3	1	2	3	4	5	6	7	8
Variable	RS	ASFF		TRUE_T	CON_ID	RFILTF	JTOL	
Type	F	I		F	F	F	F	

VARIABLE**DESCRIPTION**

MID	Material identification. A unique number or label must be specified (see *PART).
RO	Mass density
E	Young's modulus. LT.0.0: E is the Young's modulus. $E < 0$ invokes uniaxial stress for solid spot welds with the transverse stresses assumed to be zero. See Remark 1 . This is for when the keyword option is unset (<BLANK>) only.
PR	Poisson's ratio
DT	Time step size for mass scaling, Δt
TFAIL	Failure time if nonzero. If zero, this option is ignored.
EFAIL	Effective plastic strain in weld material at failure. See Remark 2 .
NF	Number of failure function evaluations stored for filtering by time averaging. The default value is set to zero which is generally recommended unless oscillatory resultant forces are observed in the time history databases. Even though these welds should not oscillate significantly, this option was added for consistency with the other spot weld options. NF affects the storage since it is necessary to store the failure terms. When NF is nonzero, the resultants in the output databases are filtered. NF cannot exceed 30.

VARIABLE	DESCRIPTION
RS	Rupture strain. See Remark 2 .
ASFF	Weld assembly simultaneous failure flag (see Remark 4): EQ.0: Damaged elements fail individually. EQ.1: Damaged elements fail when first reaches failure criterion.
TRUE_T	True weld thickness for single hexahedron solid weld elements. See Remark 3 .
CON_ID	Connection ID of *DEFINE_CONNECTION card. A negative CON_ID deactivates failure; see Remark 6 .
RFILTF	Smoothing factor on the effective strain rate (default is 0.0), potentially used in table DSIGY < 0 and in functions for PRUL.ge.2 (see *DEFINE_CONNECTION_PROPERTIES). $\dot{\epsilon}_n^{\text{avg}} = \text{RFILTF} \times \dot{\epsilon}_{n-1}^{\text{avg}} + (1 - \text{RFILTF}) \times \dot{\epsilon}_n$
JTOL	Tolerance value for relative volume change (default: JTOL = 0.01). Solid element spot welds with a Jacobian less than JTOL will be eroded.

Remarks:

1. **Loading Solid Welds Uniaxially.** We have implemented two methods of loading solid and solid weld assemblies uniaxially. The older method is invoked by defining the elastic modulus, E , as a negative number where the absolute value of E is the desired value for E . This uniaxial option causes the two transverse stress terms to be assumed to be zero throughout the calculation. This assumption eliminates parasitic transverse stress that causes slow growth of plastic strain-based damage.

The other method is invoked by setting *OPTION* to UNIAXIAL. This method is preferred. It causes the two transverse stress terms and the two transverse strains terms to be set to zero. It was added because we found that the older method sometimes induced spurious oscillations in the axial force, leading to premature failure.

The motivation for the uniaxial options can be explained with a weld loaded in tension. Due to Poisson's effect, an element in tension would be expected to contract in the transverse directions. However, because the weld nodes are constrained to the mid-plane of shell elements, such contraction is only possible to

the degree that the shell element contracts. In other words, the uniaxial stress state cannot be represented by the weld. For plastic strain-based damage, this effect can be particularly apparent as it causes tensile stress to continue to grow very large as the stress state becomes very nearly triaxial tension. In this stress state, plastic strain grows very slowly so it appears that damage calculation is failing to knock down the stress. By simply assuming that the transverse stresses are zero, the plastic strain grows as expected and damage is much more effective

2. **Connection Properties.** This weld material is modeled with isotropic hardening plasticity. The yield stress and constant hardening modulus are assumed to be those of the welded shell elements as defined in a *DEFINE_CONNECTION_PROPERTIES table. *DEFINE_CONNECTION_PROPERTIES data also define a failure function and the damage type. The interpretation of EFAIL and RS is determined by the choice of damage type. This is discussed in Remark 4 on *DEFINE_CONNECTION_PROPERTIES.
3. **Solid Weld Element Thickness.** Solid weld elements are tied to the mid-plane of shell materials and so typically have a thickness that is half the sum of the thicknesses of the welded shell sections. As a result, a weld under shear loading can be subject to an artificially large moment which will be balanced by normal forces transferred through the tied contact. These normal forces will cause the normal term in the failure calculation to be artificially high. Inputting a TRUE_T that is smaller than the modeled thickness, for example, 10%-30% of true thickness will scale down the normal force that results from the balancing moment and provide more realistic failure calculations. TRUE_T effects only the failure calculation, not the weld element behavior. If TRUE_T = 0 or data is omitted, the modeled weld element thickness is used.
4. **Weld Assembly Failure.** For weld elements in an assembly (see RPBHX on *CONTROL_SPOTWELD_BEAM or *DEFINE_HEX_SPOTWELD_ASSEMBLY), the failure criterion is evaluated using the assembly cross section. If damage is not active, all elements will be deleted when the failure criterion is met. If damage is active, then damage is calculated independently in each element of the assembly. By default, elements of the assembly are deleted as damage in each element is complete. If ASFF = 1, then failure and deletion of all elements in the assembly will occur simultaneously when damage is complete in any one of the elements.
5. **Output.** Solid element force resultants for *MAT_SPOTWELD_DAIMLERCHRYSLER are written to the spot weld force file, swforc, and the file for element stresses and resultants for designated elements, ELOUT. Also, spot weld failure data is written to the file, dcfail.
6. **Deactivating Weld Failure.** An option to deactivate weld failure is switched on by setting CON_ID to a negative value where the absolute value of CON_ID

becomes the connection ID. When weld failure is deactivated, the failure function is evaluated and output to swforc and dcfail, but the weld retains its full strength.

***MAT_GEPLASTIC_SRATE_2000a**

This is Material Type 101. The GEPLASTIC_SRATE_2000a material model characterizes General Electric's commercially available engineering thermoplastics subjected to high strain rate events. This material model features the variation of yield stress as a function of strain rate, cavitation effects of rubber modified materials, and automatic element deletion of either ductile or brittle materials.

Card 1	1	2	3	4	5	6	7	8
Variable	MID	RO	E	PR	RATESF	EDOT0	ALPHA	
Type	A	F	F	F	F	F	F	

Card 2	1	2	3	4	5	6	7	8
Variable	LCSS	LCFEPS	LCFSIG	LCE				
Type	F	F	F	F				

VARIABLE**DESCRIPTION**

MID	Material identification. A unique number or label must be specified (see *PART).
RO	Mass density
E	Young's Modulus
PR	Poisson's ratio
RATESF	Constant in plastic strain rate equation
EDOT0	Reference strain rate
ALPHA	Pressure sensitivity factor
LCSS	Load curve ID or table ID that defines the post yield material behavior. The values of this stress-strain curve are the difference of the yield stress and strain, respectively. This means the first values for both stress and strain should be zero. All subsequent values will define softening or hardening.

VARIABLE	DESCRIPTION
LCFEPS	Load curve ID that defines the plastic failure strain as a function of strain rate
LCFSIG	Load curve ID that defines the maximum principal failure stress as a function of strain rate
LCE	Load curve ID that defines the unloading moduli as a function of plastic strain

Remarks:

The constitutive model for this approach is:

$$\dot{\epsilon}_p = \dot{\epsilon}_0 \exp\{A[\sigma - S(\epsilon_p)]\} \times \exp(-p\alpha A)$$

where $\dot{\epsilon}_0$ and A are rate dependent yield stress parameters, $S(\epsilon_p)$ is the internal resistance (strain hardening), and α is a pressure dependence parameter.

In this material the yield stress may vary throughout the finite element model as a function of strain rate and hydrostatic stress. Post yield stress behavior is captured in material softening and hardening values. Finally, ductile or brittle failure measured by plastic strain or maximum principal stress, respectively, is accounted for by automatic element deletion.

Although this may be applied to a variety of engineering thermoplastics, GE Plastics have constants available for use in a wide range of commercially available grades of their engineering thermoplastics.

***MAT_INV_HYPERBOLIC_SIN_{OPTION}**

This is Material Type 102. It allows the modeling of temperature and rate dependent plasticity, Sheppard and Wright [1979].

Available options include:

<BLANK>

THERMAL

such that the keyword card can appear as:

*MAT_INV_HYPERBOLIC_SIN or *MAT_102

*MAT_INV_HYPERBOLIC_SIN_THERMAL or *MAT_102_T

Card Summary:

Card 1a. This card is included if the keyword option is unset (<BLANK>).

MID	RO	E	PR	T	HC	VP	
-----	----	---	----	---	----	----	--

Card 1b. This card is included if the THERMAL keyword option is used.

MID	RO	ALPHA	N	A	Q	G	EPSO
-----	----	-------	---	---	---	---	------

Card 2a. This card is included if the keyword option is unset (<BLANK>).

ALPHA	N	A	Q	G	EPSO	LCQ	
-------	---	---	---	---	------	-----	--

Card 2b. This card is included if the THERMAL keyword option is used.

LCE	LCPR	LCCTE					
-----	------	-------	--	--	--	--	--

Data Card Definitions:

Card 1 for no keyword option (<BLANK>)

Card 1a	1	2	3	4	5	6	7	8
Variable	MID	RO	E	PR	T	HC	VP	
Type	A	F	F	F	F	F	F	

VARIABLE	DESCRIPTION
MID	Material identification. A unique number or label must be specified (see *PART).
RO	Mass density
E	Young's Modulus
PR	Poisson's ratio
T	Initial temperature
HC	Heat generation coefficient
VP	Formulation for rate effects: EQ.0.0: Scale yield stress (default) EQ.1.0: Viscoplastic formulation

Card 1 for the THERMAL keyword option

Card 1b	1	2	3	4	5	6	7	8
Variable	MID	RO	ALPHA	N	A	Q	G	EPSO
Type	A	F	F	F	F	F	F	F

VARIABLE	DESCRIPTION
MID	Material identification. A unique number or label must be specified (see *PART).
RO	Mass density
ALPHA	α , see Remarks. Not to be confused with coefficient of thermal expansion.
N	See Remarks.
A	See Remarks.
Q	See Remarks.
G	See Remarks.

VARIABLE	DESCRIPTION
EPS0	Minimum strain rate considered in calculating Z.

Card 2 for no keyword option (<BLANK>)

Card 2a	1	2	3	4	5	6	7	8
Variable	ALPHA	N	A	Q	G	EPS0	LCQ	
Type	F	F	F	F	F	F	I	

VARIABLE	DESCRIPTION
ALPHA	α , see Remarks. Not to be confused with coefficient of thermal expansion.
N	See Remarks.
A	See Remarks.
Q	See Remarks.
G	See Remarks.
EPS0	Minimum strain rate considered in calculating Z.
LCQ	ID of curve specifying parameter Q: GT.0: Q as function of plastic strain. LT.0: Q as function of temperature.

Card 2 for the THERMAL keyword option

Card 2b	1	2	3	4	5	6	7	8
Variable	LCE	LCPR	LCCTE					
Type	F	F	F					

VARIABLE	DESCRIPTION
LCE	ID of curve defining Young's Modulus as a function of temperature

VARIABLE	DESCRIPTION
LCPR	ID of curve defining Poisson's ratio as a function of temperature
LCCTE	ID of curve defining coefficient of thermal expansion as a function of temperature

Remarks:

Resistance to deformation is both temperature and strain rate dependent. The flow stress equation is:

$$\sigma = \frac{1}{\alpha} \sinh^{-1} \left[\left(\frac{Z}{A} \right)^{\frac{1}{N}} \right]$$

where Z , the Zener-Holloman temperature compensated strain rate, is:

$$Z = \max(\dot{\epsilon}, \text{EPS0}) \times \exp \left(\frac{Q}{GT} \right) .$$

The units of the material constitutive constants are as follows: A (1/sec), N (dimensionless), α (1/MPa), the activation energy for flow, Q (J/mol), and the universal gas constant, G (J/mol K). The value of G will only vary with the unit system chosen. Typically, it will be either 8.3144 J/(mol K), or 40.8825 lb in/(mol R).

The final equation necessary to complete our description of high strain rate deformation is one that allows us to compute the temperature change during the deformation. In the absence of a coupled thermo-mechanical finite element code we assume adiabatic temperature change and follow the empirical assumption that 90-95% of the plastic work is dissipated as heat. Thus, the heat generation coefficient is

$$\text{HC} \approx \frac{0.9}{\rho C_v}$$

where ρ is the density of the material and C_v is the specific heat.

***MAT_ANISOTROPIC_VISCOPLASTIC**

This is Material Type 103. This anisotropic-viscoplastic material model applies to shell, thick shell, solid, and SPH elements. The material constants may be fit directly or, if desired, stress as a function of strain data may be input and a least squares fit will be performed by LS-DYNA to determine the constants. Kinematic, isotropic, or a combination of kinematic and isotropic hardening may be used. A detailed description of this model can be found in the following references: Berstad, Langseth, and Hopperstad [1994]; Hopperstad and Remseth [1995]; and Berstad [1996]. Failure is based on effective plastic strain or by a user defined subroutine.

Card Summary:

Card 1. This card is required.

MID	RO	E	PR	SIGY	FLAG	LCSS	ALPHA
-----	----	---	----	------	------	------	-------

Card 2. This card is required

QR1	CR1	QR2	CR2	QX1	CX1	QX2	CX2
-----	-----	-----	-----	-----	-----	-----	-----

Card 3a. This card is included for shell elements and thick shell formulations 1, 2, and 6.

VK	VM	R00	R45	R90			
----	----	-----	-----	-----	--	--	--

Card 3b. This card is included for solid elements, SPH elements, and thick shell formulations 3, 5, and 7.

VK	VM	F	G	H	L	M	N
----	----	---	---	---	---	---	---

Card 4. This card is required.

AOPT	FAIL	NUMINT	MACF				
------	------	--------	------	--	--	--	--

Card 5. This card is required.

XP	YP	ZP	A1	A2	A3		
----	----	----	----	----	----	--	--

Card 6. This card is required.

V1	V2	V3	D1	D2	D3	BETA	
----	----	----	----	----	----	------	--

Data Card Definitions:

Card 1	1	2	3	4	5	6	7	8
Variable	MID	RO	E	PR	SIGY	FLAG	LCSS	ALPHA
Type	A	F	F	F	F	F	F	F

VARIABLE**DESCRIPTION**

MID	Material identification. A unique number or label must be specified.
RO	Mass density
E	Young's modulus
PR	Poisson's ratio
SIGY	Initial yield stress
FLAG	Flag: <ul style="list-style-type: none"> EQ.0: Give all material parameters EQ.1: Material parameters Q_{r1}, C_{r1}, Q_{r2}, and C_{r2} for pure isotropic hardening ($\alpha = 1$) are determined by a least squares fit to the curve or table specified by the variable LCSS. If α is input as less than 1, Q_{r1} and Q_{r2} are then modified by multiplying them by the factor α, while the factors Q_{x1} and Q_{x2} are taken as the product of the factor $(1 - \alpha)$ and the original parameters Q_{r1} and Q_{r2}, respectively, for pure isotropic hardening. C_{x1} is set equal to C_{r1} and C_{x2} is set equal to C_{r2}. α is input as variable ALPHA on Card 1. EQ.2: Use load curve directly, that is, no fitting is required for the parameters Q_{r1}, C_{r1}, Q_{r2}, and C_{r2}. A table is not allowed and only isotropic hardening is implemented. EQ.4: Use table definition directly. No fitting is required and the values for Q_{r1}, C_{r1}, Q_{r2}, C_{r2}, V_k, and V_m are ignored. Only isotropic hardening is implemented, and this option is only available for solids.

VARIABLE	DESCRIPTION
----------	-------------

LCSS Load curve ID or Table ID. Card 2 is ignored with this option.

Load Curve ID. The load curve ID defines effective stress as a function of effective plastic strain. For this load curve case, viscoplasticity is modeled when the coefficients V_k and V_m are provided.

Table ID. The table consists of stress as a function of effective plastic strain curves indexed by strain rate. See [Figure M24-1](#).

FLAG.EQ.1: Table is used to calculate the coefficients V_k and V_m .

FLAG.EQ.4: Table is interpolated and used directly. This option is available only for solid elements.

ALPHA α distribution of hardening used in the curve-fitting. $\alpha = 0$ is pure kinematic hardening while $\alpha = 1$ provides pure isotropic hardening.

Card 2	1	2	3	4	5	6	7	8
Variable	QR1	CR1	QR2	CR2	QX1	CX1	QX2	CX2
Type	F	F	F	F	F	F	F	F

VARIABLE	DESCRIPTION
----------	-------------

QR1 Isotropic hardening parameter Q_{r1}

CR1 Isotropic hardening parameter C_{r1}

QR2 Isotropic hardening parameter Q_{r2}

CR2 Isotropic hardening parameter C_{r2}

QX1 Kinematic hardening parameter $Q_{\chi1}$

CX1 Kinematic hardening parameter $C_{\chi1}$

QX2 Kinematic hardening parameter $Q_{\chi2}$

CX2 Kinematic hardening parameter $C_{\chi2}$

Shell Elements Card. This card is included for shell elements and thick shell formulations 1, 2, and 6.

Card 3a	1	2	3	4	5	6	7	8
Variable	VK	VM	R00	R45	R90			
Type	F	F	F	F	F			

VARIABLE**DESCRIPTION**

VK	Viscous material parameter V_k
VM	Viscous material parameter V_m
R00	R_{00} for shell (default = 1.0)
R45	R_{45} for shell (default = 1.0)
R90	R_{90} for shell (default = 1.0)

Solid Elements Card. This card is included for solid elements, SPH elements, and thick shell formulations 3, 5, and 7.

Card 3b	1	2	3	4	5	6	7	8
Variable	VK	VM	F	G	H	L	M	N
Type	F	F	F	F	F	F	F	F

VARIABLE**DESCRIPTION**

VK	Viscous material parameter V_k
VM	Viscous material parameter V_m
F	F in yield criteria (default = 1/2); see Remarks
G	G in yield criteria (default = 1/2); see Remarks
H	H in yield criteria (default = 1/2); see Remarks
L	L in yield criteria (default = 3/2); see Remarks
M	M in yield criteria (default = 3/2); see Remarks

VARIABLE

DESCRIPTION

N N in yield criteria (default = 3/2); see Remarks

Card 4	1	2	3	4	5	6	7	8
Variable	AOPT	FAIL	NUMINT	MACF				
Type	F	F	F	I				

VARIABLE

DESCRIPTION

AOPT Material axes option (see MAT_OPTIONTROPIC_ELASTIC, particularly the [Material Directions](#) section, for details):

EQ.0.0: Locally orthotropic with material axes determined by element nodes 1, 2, and 4, as with *DEFINE_COORDINATE_NODES. For shells only, the material axes are then rotated about the normal vector to the surface of the shell by the angle BETA.

EQ.1.0: Locally orthotropic with material axes determined by a point, *P*, in space and the global location of the element center; this is the **a**-direction. This option is for solid elements only.

EQ.2.0: Globally orthotropic with material axes determined by vectors defined below, as with *DEFINE_COORDINATE_VECTOR

VARIABLE	DESCRIPTION
	<p>EQ.3.0: Locally orthotropic material axes determined by a vector \mathbf{v} and the normal vector to the plane of the element. The plane of a solid element is the midsurface between the inner surface and outer surface defined by the first four nodes and the last four nodes of the connectivity of the element, respectively. Thus, for solid elements, AOPT = 3 is only available for hexahedrons. \mathbf{a} is determined by taking the cross product of \mathbf{v} with the normal vector, \mathbf{b} is determined by taking the cross product of the normal vector with \mathbf{a}, and \mathbf{c} is the normal vector. Then \mathbf{a} and \mathbf{b} are rotated about \mathbf{c} by an angle BETA. BETA may be set in the keyword input for the element or in the input for this keyword. Note that for solids, the material axes may be switched depending on the choice of MACF. The switch may occur before or after applying BETA depending on the value of MACF.</p>
	<p>EQ.4.0: Locally orthotropic in a cylindrical coordinate system with the material axes determined by a vector \mathbf{v}, and an originating point, P, which define the centerline axis. This option is for solid elements only.</p>
	<p>LT.0.0: The absolute value of AOPT is a coordinate system ID number (CID on *DEFINE_COORDINATE_OPTION).</p>
FAIL	<p>Failure flag:</p> <p>LT.0.0: User defined failure subroutine is called to determine failure. This is subroutine named, MATUSR_103, in dyn21.f.</p> <p>EQ.0.0: Failure is not considered. This option is recommended if failure is not of interest since many calculations will be saved.</p> <p>GT.0.0: Plastic strain to failure. When the plastic strain reaches this value, the element is deleted from the calculation.</p>

VARIABLE	DESCRIPTION
-----------------	--------------------

NUMINT	Number of integration points which must fail before element deletion. If zero, all points must fail. This option applies to shell elements only. For the case of one point shells, NUMINT should be set to a value that is less than the number of through thickness integration points. Nonphysical stretching can sometimes appear in the results if all integration points have failed except for one point away from the midsurface because unconstrained nodal rotations will prevent strains from developing at the remaining integration point. In fully integrated shells, similar problems can occur.
--------	--

MACF	<p>Material axes change flag for solid elements:</p> <p>EQ.-4: Switch material axes <i>b</i> and <i>c</i> before BETA rotation</p> <p>EQ.-3: Switch material axes <i>a</i> and <i>c</i> before BETA rotation</p> <p>EQ.-2: Switch material axes <i>a</i> and <i>b</i> before BETA rotation</p> <p>EQ.1: No change, default</p> <p>EQ.2: Switch material axes <i>a</i> and <i>b</i> after BETA rotation</p> <p>EQ.3: Switch material axes <i>a</i> and <i>c</i> after BETA rotation</p> <p>EQ.4: Switch material axes <i>b</i> and <i>c</i> after BETA rotation</p>
------	--

Figure M2-2 indicates when LS-DYNA applies MACF during the process to obtain the final material axes. If BETA on *ELEMENT_SOLID_{OPTION} is defined, then that BETA is used for the rotation for all AOPT options. Otherwise, if AOPT = 3, the BETA input on Card 6 rotates the axes. For all other values of AOPT, the material axes will be switched as specified by MACF, but no BETA rotation will be performed.

Card 5	1	2	3	4	5	6	7	8
Variable	XP	YP	ZP	A1	A2	A3		
Type	F	F	F	F	F	F		

VARIABLE	DESCRIPTION
-----------------	--------------------

XP, YP, ZP	Coordinates of point <i>p</i> for AOPT = 1 and 4
------------	--

A1, A2, A3	Components of vector a for AOPT = 2
------------	--

Card 6	1	2	3	4	5	6	7	8
Variable	V1	V2	V3	D1	D2	D3	BETA	
Type	F	F	F	F	F	F	F	

VARIABLE**DESCRIPTION**

V1, V2, V3

Components of vector **v** for AOPT = 3 and 4

D1, D2, D3

Components of vector **d** for AOPT = 2

BETA

Material angle in degrees for AOPT = 0 (shells and thick shells only) and AOPT = 3. BETA may be overridden on the element card; see *ELEMENT_SHELL_BETA, *ELEMENT_TSHELL_BETA, and *ELEMENT_SOLID_ORTHO.

Remarks:

The uniaxial stress-strain curve is given on the following form

$$\sigma(\varepsilon_{\text{eff}}^p, \dot{\varepsilon}_{\text{eff}}^p) = \sigma_0 + Q_{r1}[(1 - \exp(-C_{r1}\varepsilon_{\text{eff}}^p))] + Q_{r2}[1 - \exp(-C_{r2}\varepsilon_{\text{eff}}^p)] \\ + Q_{\chi1}[(1 - \exp(-C_{\chi1}\varepsilon_{\text{eff}}^p))] + Q_{\chi2}[(1 - \exp(-C_{\chi2}\varepsilon_{\text{eff}}^p))] + V_k \dot{\varepsilon}_{\text{eff}}^p V_m$$

For solids the following yield criteria is used

$$F(\sigma_{22} - \sigma_{33})^2 + G(\sigma_{33} - \sigma_{11})^2 + H(\sigma_{11} - \sigma_{22})^2 + 2L\sigma_{23}^2 + 2M\sigma_{31}^2 + 2N\sigma_{12}^2 \\ = [\sigma(\varepsilon_{\text{eff}}^p, \dot{\varepsilon}_{\text{eff}}^p)]^2$$

where $\varepsilon_{\text{eff}}^p$ is the effective plastic strain and $\dot{\varepsilon}_{\text{eff}}^p$ is the effective plastic strain rate. For shells the anisotropic behavior is given by R_{00} , R_{45} and R_{90} . The model will work when the three first parameters in Card 3 are given values. When $V_k = 0$, the material will behave elasto-plastically. Default values are given by:

$$F = G = H = \frac{1}{2}$$

$$L = M = N = \frac{3}{2}$$

$$R_{00} = R_{45} = R_{90} = 1$$

Strain rates are accounted for using the Cowper and Symonds model which scales the yield stress with the factor:

$$1 + \left(\frac{\dot{\varepsilon}_{\text{eff}}^p}{C}\right)^{1/p}$$

To convert these constants set the viscoelastic constants, V_k and V_m , to the following values:

$$V_k = \left(\frac{1}{C}\right)^{\frac{1}{p}}$$
$$V_m = \frac{1}{p}$$

If LCSS is nonzero, substitute the initial, quasi-static yield stress for SIGY in the equation for V_k above.

This model properly treats rate effects. The viscoplastic rate formulation is an option in other plasticity models in LS-DYNA, such as *MAT_003 and *MAT_024, invoked by setting the parameter VP to 1.

*MAT_ANISOTROPIC_PLASTIC

This is Material Type 103_P. This anisotropic-plastic material model is a simplified version of the MAT_ANISOTROPIC_VISCOPLASTIC above. This material model applies only to shell elements.

Card 1	1	2	3	4	5	6	7	8
Variable	MID	R0	E	PR	SIGY	LCSS		
Type	A	F	F	F	F	F		

Card 2	1	2	3	4	5	6	7	8
Variable	QR1	CR1	QR2	CR2				
Type	F	F	F	F				

Card 3	1	2	3	4	5	6	7	8
Variable	R00	R45	R90	S11	S22	S33	S12	
Type	F	F	F	F	F	F	F	

Card 4	1	2	3	4	5	6	7	8
Variable	AOPT							
Type	F							

Card 5	1	2	3	4	5	6	7	8
Variable	XP	YP	ZP	A1	A2	A3		
Type	F	F	F	F	F	F		

Card 6	1	2	3	4	5	6	7	8
Variable	V1	V2	V3	D1	D2	D3	BETA	
Type	F	F	F	F	F	F	F	

VARIABLE**DESCRIPTION**

MID	Material identification. A unique number or label must be specified (see *PART).
RO	Mass density
E	Young's modulus
PR	Poisson's ratio
SIGY	Initial yield stress
LCSS	Load curve ID. The load curve ID defines effective stress as a function of effective plastic strain. Card 2 is ignored with this option.
QR1	Isotropic hardening parameter Q_{r1}
CR1	Isotropic hardening parameter C_{r1}
QR2	Isotropic hardening parameter Q_{r2}
CR2	Isotropic hardening parameter C_{r2}
R00	R_{00} for anisotropic hardening
R45	R_{45} for anisotropic hardening
R90	R_{90} for anisotropic hardening
S11	Yield stress in local x -direction. This input is ignored if $(R_{00}, R_{45}, R_{90}) > 0$.
S22	Yield stress in local y -direction. This input is ignored if $(R_{00}, R_{45}, R_{90}) > 0$.
S33	Yield stress in local z -direction. This input is ignored if $(R_{00}, R_{45}, R_{90}) > 0$.

VARIABLE	DESCRIPTION
S12	Yield stress in local xy -direction. This input is ignored if $(R_{00}, R_{45}, R_{90}) > 0$.
AOPT	Material axes option (see MAT_OPTIONTROPIC_ELASTIC for a more complete description): <p>EQ.0.0: Locally orthotropic with material axes determined by element nodes 1, 2, and 4, as with *DEFINE_COORDINATE_NODES, and then rotated about the shell element normal by an angle BETA.</p> <p>EQ.2.0: Globally orthotropic with material axes determined by vectors defined below, as with *DEFINE_COORDINATE_VECTOR.</p> <p>EQ.3.0: Locally orthotropic material axes determined by rotating the material axes about the element normal by an angle, BETA, from a line in the plane of the element defined by the cross product of the vector \mathbf{v} with the element normal.</p> <p>LT.0.0: The absolute value of AOPT is a coordinate system ID number (CID on *DEFINE_COORDINATE_NODES, *DEFINE_COORDINATE_SYSTEM or *DEFINE_COORDINATE_VECTOR). Available in R3 version of 971 and later.</p>
XP, YP, ZP	x_p, y_p, z_p define coordinates of point \mathbf{p} for AOPT = 1 and 4.
A1, A2, A3	a_1, a_2, a_3 define components of vector \mathbf{a} for AOPT = 2.
D1, D2, D3	d_1, d_2, d_3 define components of vector \mathbf{d} for AOPT = 2.
V1, V2, V3	v_1, v_2, v_3 define components of vector \mathbf{v} for AOPT = 3 and 4.
BETA	Material angle in degrees for AOPT = 0 and 3, may be overridden on the element card, see *ELEMENT_SHELL_BETA.

Remarks:

If no load curve is defined for the effective stress versus effective plastic strain, the uniaxial stress-strain curve is given on the following form

$$\sigma(\varepsilon_{\text{eff}}^p) = \sigma_0 + Q_{r1}[1 - \exp(-C_{r1}\varepsilon_{\text{eff}}^p)] + Q_{r2}[1 - \exp(-C_{r2}\varepsilon_{\text{eff}}^p)]$$

where $\varepsilon_{\text{eff}}^p$ is the effective plastic strain. For shells the anisotropic behavior is given by R_{00} , R_{45} and R_{90} , or the yield stress in the different direction. Default values are given by:

$$R_{00} = R_{45} = R_{90} = 1$$

if the variables R_{00} , R_{45} , R_{90} , S_{11} , S_{22} , S_{33} and S_{12} are set to zero.

*MAT_DAMAGE_1

This is Material Type 104. This is a continuum damage mechanics (CDM) model which includes anisotropy and viscoplasticity. The CDM model applies to shell, thick shell, and solid elements. A more detailed description of this model can be found in the paper by Berstad, Hopperstad, Lademo, and Malo [1999]. This material model can also model anisotropic damage behavior by setting FLAG to -1 in Card 2.

Card Summary:

Card 1. This card is required.

MID	RO	E	PR	SIGY	LCSS	LCDS	
-----	----	---	----	------	------	------	--

Card 2a. This card is included if FLAG = -1.

Q1	C1	Q2	C2	EPSD	EPSR		FLAG
----	----	----	----	------	------	--	------

Card 2b. This card is included if FLAG ≥ 0.

Q1	C1	Q2	C2	EPSD	S	DC	FLAG
----	----	----	----	------	---	----	------

Card 3a. This card is included if the element type is shells or thick shells.

VK	VM	R00	R45	R90			
----	----	-----	-----	-----	--	--	--

Card 3b. This card is included if the element type is solids.

VK	VM	F	G	H	L	M	N
----	----	---	---	---	---	---	---

Card 4. This card is required.

AOPT		CPH	MACF	Y0	ALPHA	THETA	ETA
------	--	-----	------	----	-------	-------	-----

Card 5. This card is required.

XP	YP	ZP	A1	A2	A3		
----	----	----	----	----	----	--	--

Card 6. This card is required.

V1	V2	V3	D1	D2	D3	BETA	
----	----	----	----	----	----	------	--

Data Card Definitions:

Card 1	1	2	3	4	5	6	7	8
Variable	MID	RO	E	PR	SIGY	LCSS	LCDS	
Type	A	F	F	F	F	I	I	

VARIABLE**DESCRIPTION**

MID	Material identification. A unique number or label must be specified (see *PART).
RO	Mass density
E	Young's modulus
PR	Poisson's ratio
SIGY	Initial yield stress, σ_0
LCSS	Load curve ID defining effective stress as a function of effective plastic strain. Isotropic hardening parameters on Card 2 are ignored with this option.
LCDS	Load curve ID defining nonlinear damage curve for FLAG = -1.

Anisotropic Damage Card. This card is included if FLAG = -1.

Card 2a	1	2	3	4	5	6	7	8
Variable	Q1	C1	Q2	C2	EPSD	EPSR		FLAG
Type	F	F	F	F	F	F		F

VARIABLE**DESCRIPTION**

Q1	Isotropic hardening parameter Q_1
C1	Isotropic hardening parameter C_1
Q2	Isotropic hardening parameter Q_2
C2	Isotropic hardening parameter C_2

VARIABLE	DESCRIPTION
EPSD	Damage threshold $\varepsilon_{\text{eff,d}}^p$. Damage effective plastic strain when material softening begins (default = 0.0).
EPSR	Effective plastic strain at which material ruptures (logarithmic).
FLAG	Damage type flag: EQ.-1: Anisotropic damage check (<i>only for shell elements</i>) EQ.0: Standard isotropic damage (default) EQ.1: Standard isotropic damage plus strain localization check (<i>only for shell elements</i>) EQ.10: Enhanced isotropic damage EQ.11: Enhanced isotropic damage plus strain localization check (<i>only for shell elements</i>)

Isotropic Damage Only Card. This card is included if FLAG ≥ 0 .

Card 2b	1	2	3	4	5	6	7	8
Variable	Q1	C1	Q2	C2	EPSD	S	DC	FLAG
Type	F	F	F	F	F	F	F	F

VARIABLE	DESCRIPTION
Q1	Isotropic hardening parameter Q_1
C1	Isotropic hardening parameter C_1
Q2	Isotropic hardening parameter Q_2
C2	Isotropic hardening parameter C_2
EPSD	Damage threshold $\varepsilon_{\text{eff,d}}^p$. Damage effective plastic strain when material softening begins (default = 0.0).
S	Damage material constant S (default = $\frac{\sigma_0}{200}$)
DC	Critical damage value D_C (default = 0.5). When the damage value, D , reaches this value, the element is deleted from the calculation.

VARIABLE	DESCRIPTION
FLAG	Damage type flag: EQ.-1: Anisotropic damage check (<i>only for shell elements</i>) EQ.0: Standard isotropic damage (default) EQ.1: Standard isotropic damage plus strain localization check (<i>only for shell elements</i>) EQ.10: Enhanced isotropic damage EQ.11: Enhanced isotropic damage plus strain localization check (<i>only for shell elements</i>)

Shell Element Material Parameters Card. This card is included for shell or thick shell elements.

Card 3a	1	2	3	4	5	6	7	8
Variable	VK	VM	R00	R45	R90			
Type	F	F	F	F	F			

VARIABLE	DESCRIPTION
VK	Viscous material parameter, V_k
VM	Viscous material parameter, V_m
R00	R_{00} for shell (default = 1.0)
R45	R_{45} for shell (default = 1.0)
R90	R_{90} for shell (default = 1.0)

Brick Element Material Parameters Card. This card is included for solid elements.

Card 3a	1	2	3	4	5	6	7	8
Variable	VK	VM	F	G	H	L	M	N
Type	F	F	F	F	F	F	F	F

VARIABLE	DESCRIPTION
VK	Viscous material parameter, V_k
VM	Viscous material parameter, V_m
F	F for solid (default = 1/2)
G	G for solid (default = 1/2)
H	H for solid (default = 1/2)
L	L for solid (default = 3/2)
M	M for solid (default = 3/2)
N	N for solid (default = 3/2)

Card 4	1	2	3	4	5	6	7	8
Variable	AOPT		CPH	MACF	Y0	ALPHA	THETA	ETA
Type	F		F	I	F	F	F	F

VARIABLE	DESCRIPTION
AOPT	<p>Material axes option (see MAT_OPTIONTROPIC_ELASTIC, particularly the Material Directions section, for details):</p> <p>EQ.0.0: Locally orthotropic with material axes determined by element nodes 1, 2, and 4, as with *DEFINE_COORDINATE_NODES. For shells only, the material axes are then rotated about the normal vector to the surface of the shell by the angle BETA.</p> <p>EQ.1.0: Locally orthotropic with material axes determined by a point, P, in space and the global location of the element center; this is the a-direction. This option is for solid elements only.</p> <p>EQ.2.0: Globally orthotropic with material axes determined by vectors defined below, as with *DEFINE_COORDINATE_VECTOR</p>

VARIABLE**DESCRIPTION**

- EQ.3.0: Locally orthotropic material axes determined by a vector \mathbf{v} and the normal vector to the plane of the element. The plane of a solid element is the midsurface between the inner surface and outer surface defined by the first four nodes and the last four nodes of the connectivity of the element, respectively. Thus, for solid elements, AOPT = 3 is only available for hexahedrons. \mathbf{a} is determined by taking the cross product of \mathbf{v} with the normal vector, \mathbf{b} is determined by taking the cross product of the normal vector with \mathbf{a} , and \mathbf{c} is the normal vector. Then \mathbf{a} and \mathbf{b} are rotated about \mathbf{c} by an angle BETA. BETA may be set in the keyword input for the element or in the input for this keyword. Note that for solids, the material axes may be switched depending on the choice of MACF. The switch may occur before or after applying BETA depending on the value of MACF.
- EQ.4.0: Locally orthotropic in a cylindrical coordinate system with the material axes determined by a vector \mathbf{v} , and an originating point, P , which define the centerline axis. This option is for solid elements only.
- LT.0.0: The absolute value of AOPT is a coordinate system ID number (CID on *DEFINE_COORDINATE_OPTION).
- CPH Microdefects closure parameter h for enhanced damage (FLAG \geq 10).

VARIABLE	DESCRIPTION
----------	-------------

MACF Material axes change flag for solid elements:

EQ.-4: Switch material axes *b* and *c* before BETA rotation
 EQ.-3: Switch material axes *a* and *c* before BETA rotation
 EQ.-2: Switch material axes *a* and *b* before BETA rotation
 EQ.1: No change, default
 EQ.2: Switch material axes *a* and *b* after BETA rotation
 EQ.3: Switch material axes *a* and *c* after BETA rotation
 EQ.4: Switch material axes *b* and *c* after BETA rotation

Figure M2-2 indicates when LS-DYNA applies MACF during the process to obtain the final material axes. If BETA on *ELEMENT_-SOLID_{OPTION} is defined, then that BETA is used for the rotation for all AOPT options. Otherwise, if AOPT = 3, the BETA input on Card 6 rotates the axes. For all other values of AOPT, the material axes will be switched as specified by MACF, but no BETA rotation will be performed.

Y0 Initial damage energy release rate, Y_0 , for enhanced damage (FLAG ≥ 10).

ALPHA Exponent α for enhanced damage (FLAG ≥ 10)

THETA Exponent θ for enhanced damage (FLAG ≥ 10)

ETA Exponent η for enhanced damage (FLAG ≥ 10)

Card 5	1	2	3	4	5	6	7	8
Variable	XP	YP	ZP	A1	A2	A3		
Type	F	F	F	F	F	F		

VARIABLE	DESCRIPTION
----------	-------------

XP, YP, ZP Coordinates of point *p* for AOPT = 1 and 4

A1, A2, A3 Components of vector **a** for AOPT = 2

Card 6	1	2	3	4	5	6	7	8
Variable	V1	V2	V3	D1	D2	D3	BETA	
Type	F	F	F	F	F	F	F	

VARIABLE**DESCRIPTION**

D1, D2, D3

Components of vector **d** for AOPT = 2

V1, V2, V3

Components of vector **v** for AOPT = 3 and 4

BETA

Material angle in degrees for AOPT = 0 (shells only) and AOPT = 3. BETA may be overridden on the element card; see *ELEMENT_SHELL_BETA, *ELEMENT_TSHHELL_BETA, and *ELEMENT_SOLID_ORTHO.

Remarks:

1. **Standard Isotropic Damage Model (FLAG = 0 or 1).** The Continuum Damage Mechanics (CDM) model is based on an approach proposed by Lemaitre [1992]. The effective stress $\tilde{\sigma}$, which is the stress calculated over the section that effectively resist the forces, reads

$$\tilde{\sigma} = \frac{\sigma}{1 - D}$$

where D is the damage variable. The evolution equation for the damage variable is defined as

$$\dot{D} = \begin{cases} 0 & \text{for } \varepsilon_{\text{eff}}^p \leq \varepsilon_{\text{eff,d}}^p \\ \frac{Y}{S} \dot{\varepsilon}_{\text{eff}}^p & \text{for } \varepsilon_{\text{eff}}^p > \varepsilon_{\text{eff,d}}^p \text{ and } \sigma_1 > 0 \end{cases}$$

where $\varepsilon_{\text{eff,d}}^p$ is the damage threshold, S is the so-called damage energy release rate, and σ_1 is the maximum principal stress. The damage energy density release rate is

$$Y = \frac{1}{2} \mathbf{e}_e : \mathbf{C} : \mathbf{e}_e = \frac{\sigma_{vm}^2 R_v}{2E(1 - D)^2}$$

where E is Young's modulus and σ_{vm} is the equivalent von Mises stress. The triaxiality function R_v is defined as

$$R_v = \frac{2}{3} (1 + \nu) + 3(1 - 2\nu) \left(\frac{\sigma_H}{\sigma_{vm}} \right)^2$$

with Poisson's ratio ν and hydrostatic stress σ_H .

2. **Enhanced isotropic damage model (FLAG = 10 or 11).** A more sophisticated damage model that includes crack closure effects (reduced damage under compression) and more flexibility in stress state dependence and functional expressions is invoked by setting FLAG = 10 or 11. The corresponding evolution equation for the damage variable is defined as

$$\dot{D} = \left(\frac{2\tau_{\max}}{\sigma_{vm}} \right)^\eta \left\langle \frac{Y - Y_0}{S} \right\rangle^\alpha (1 - D)^{1-\theta} \dot{\epsilon}_{\text{eff}}^p$$

where τ_{\max} is the maximum shear stress, Y_0 is the initial damage energy release rate, and η , α , and θ are additional material constants. $\langle \rangle$ are the *Macauley brackets*. The damage energy density release rate is

$$Y = \frac{1 + \nu}{2E} \left(\sum_{i=1}^3 (\langle \tilde{\sigma}_i \rangle^2 + h \langle -\tilde{\sigma}_i \rangle^2) \right) - \frac{\nu}{2E} (\langle \tilde{\sigma}_H \rangle^2 + h \langle -\tilde{\sigma}_H \rangle^2)$$

where $\tilde{\sigma}_i$ are the principal effective stresses and h is the microdefects closure parameter that accounts for different damage behavior in tension and compression. A value of $h \approx 0.2$ is typically observed in many experiments as stated in Lemaitre [2000]. A parameter set of $h = 1$, $Y_0 = 0$, $\alpha = 1$, $\theta = 1$, and $\eta = 0$ should give the same results as the standard isotropic damage model (FLAG = 0 or 1) with $\epsilon_{\text{eff,d}}^p = 0$ as long as $\sigma_1 > 0$.

3. **Strain Localization Check (FLAG = 1 or 11).** In order to add strain localization computation to the damage models above, parameter FLAG should be set to 1 (standard damage) or 11 (enhanced damage). An acoustic tensor-based bifurcation criterion is checked and history variable no. 4 is set to 1.0 if strain localization is indicated. This is only available for shell elements.
4. **Anisotropic Damage Model (FLAG = -1).** At each thickness integration points, an anisotropic damage law acts on the plane stress tensor in the directions of the principal total shell strains, ϵ_1 and ϵ_2 , as follows:

$$\sigma_{11} = [1 - D_1(\epsilon_1)]\sigma_{110}$$

$$\sigma_{22} = [1 - D_2(\epsilon_2)]\sigma_{220}$$

$$\sigma_{12} = \left[1 - \frac{D_1 + D_2}{2} \right] \sigma_{120}$$

The transverse plate shear stresses in the principal strain directions are assumed to be damaged as follows:

$$\sigma_{13} = (1 - D_1/2)\sigma_{130}$$

$$\sigma_{23} = (1 - D_2/2)\sigma_{230}$$

In the anisotropic damage formulation, $D_1(\varepsilon_1)$ and $D_2(\varepsilon_2)$ are anisotropic damage functions for the loading directions 1 and 2, respectively. Stresses σ_{110} , σ_{220} , σ_{120} , σ_{130} and σ_{230} are stresses in the principal shell strain directions as calculated from the undamaged elastic-plastic material behavior. The strains ε_1 and ε_2 are the magnitude of the principal strains calculated upon reaching the damage thresholds. Damage can only develop for tensile stresses, and the damage functions $D_1(\varepsilon_1)$ and $D_2(\varepsilon_2)$ are identical to zero for negative strains ε_1 and ε_2 . The principal strain directions are fixed within an integration point as soon as either principal strain exceeds the initial threshold strain in tension. A more detailed description of the damage evolution for this material model is given in the description of Material 81.

5. **Anisotropic Viscoplasticity.** The uniaxial stress-strain curve is given in the following form

$$\sigma(r, \dot{\varepsilon}_{\text{eff}}^p) = \sigma_0 + Q_1[1 - \exp(-C_1 r)] + Q_2[1 - \exp(-C_2 r)] + V_k \dot{\varepsilon}_{\text{eff}}^p V_m,$$

where r is the damage accumulated plastic strain, which can be calculated by

$$\dot{r} = \dot{\varepsilon}_{\text{eff}}^p (1 - D).$$

For bricks the following yield criterion associated with the Hill criterion is used

$$F(\tilde{\sigma}_{22} - \tilde{\sigma}_{33})^2 + G(\tilde{\sigma}_{33} - \tilde{\sigma}_{11})^2 + H(\tilde{\sigma}_{11} - \tilde{\sigma}_{22})^2 + 2L\tilde{\sigma}_{23}^2 + 2M\tilde{\sigma}_{31}^2 + 2N\tilde{\sigma}_{12}^2 = \sigma(r, \dot{\varepsilon}_{\text{eff}}^p)$$

where r is the damage effective viscoplastic strain and $\dot{\varepsilon}_{\text{eff}}^p$ is the effective viscoplastic strain rate. For shells the anisotropic behavior is given by the R-values: R_{00} , R_{45} , and R_{90} . When $V_k = 0$, the material will behave as an elastoplastic material without rate effects. Default values for the anisotropic constants are given by:

$$F = G = H = \frac{1}{2}$$

$$L = M = N = \frac{3}{2}$$

$$R_{00} = R_{45} = R_{90} = 1$$

so that isotropic behavior is obtained.

Strain rate is accounted for using the Cowper and Symonds model which scales the yield stress with the factor:

$$1 + \left(\frac{\dot{\varepsilon}}{C}\right)^{1/p}$$

To convert these constants, set the viscoelastic constants, V_k and V_m , to the following values:

$$V_k = \sigma \left(\frac{1}{C} \right)^{\frac{1}{p}}$$
$$V_m = \frac{1}{p}$$

***MAT_DAMAGE_2**

This is Material Type 105. This is an elastic viscoplastic material model combined with continuum damage mechanics (CDM). This material model applies to shell, thick shell, and brick elements. The elastoplastic behavior is described in the description of material model 24. A more detailed description of the CDM model is given in the description of material model 104 above.

Card Summary:

Card 1. This card is required.

MID	RO	E	PR	SIGY	ETAN	FAIL	TDEL
-----	----	---	----	------	------	------	------

Card 2. This card is required.

C	P	LCSS	LCSR				
---	---	------	------	--	--	--	--

Card 3. This card is required.

EPSD	S	DC					
------	---	----	--	--	--	--	--

Card 4. This card is required.

EPS1	EPS2	EPS3	EPS4	EPS5	EPS6	EPS7	EPS8
------	------	------	------	------	------	------	------

Card 5. This card is required.

ES1	ES2	ES3	ES4	ES5	ES6	ES7	ES8
-----	-----	-----	-----	-----	-----	-----	-----

Data Card Definitions:

Card 1	1	2	3	4	5	6	7	8
Variable	MID	RO	E	PR	SIGY	ETAN	FAIL	TDEL
Type	A	F	F	F	F	F	F	F
Default	none	none	none	none	none	0.0	10 ²⁰	0.0

VARIABLE	DESCRIPTION
MID	Material identification. A unique number or label must be specified (see *PART).
RO	Mass density
E	Young's modulus
PR	Poisson's ratio
SIGY	Yield stress
ETAN	Tangent modulus; ignored if LCSS > 0
FAIL	Failure flag: EQ.0.0: Failure due to plastic strain is not considered. GT.0.0: Plastic strain to failure. When the plastic strain reaches this value, the element is deleted from the calculation.
TDEL	Minimum time step size for automatic element deletion

Card 2	1	2	3	4	5	6	7	8
Variable	C	P	LCSS	LCSR				
Type	F	F	I	I				
Default	0.0	0.0	0	0				

VARIABLE	DESCRIPTION
C	Strain rate parameter, <i>C</i> ; see Remarks below.
P	Strain rate parameter, <i>p</i> ; see Remarks below.

VARIABLE	DESCRIPTION
-----------------	--------------------

LCSS	Load curve ID or Table ID. Load curve ID defining effective stress as a function of effective plastic strain. If defined EPS1 - EPS8 and ES1 - ES8 are ignored. The table ID defines for each strain rate value a load curve ID giving the stress as a function of effective plastic strain for that rate, See Figure M24-1 . The stress as a function of effective plastic strain curve for the lowest value of strain rate is used if the strain rate falls below the minimum value. Likewise, the stress as a function of effective plastic strain curve for the highest value of strain rate is used if the strain rate exceeds the maximum value. The strain rate parameters, C and P; the curve ID, LCSR; EPS1 - EPS8; and ES1 - ES8 are ignored if a Table ID is defined.
------	--

LCSR	Load curve ID defining strain rate scaling effect on yield stress
------	---

Card 3	1	2	3	4	5	6	7	8
Variable	EPSD	S	DC					
Type	F	F	F					
Default	0.0	↓	0.5					

VARIABLE	DESCRIPTION
-----------------	--------------------

EPSD	Damage threshold, r_d . Damage effective plastic strain when material softening begins.
------	---

S	Damage material constant S . Default = $\sigma_0/200$.
---	---

DC	Critical damage value D_C . When the damage value D reaches this value, the element is deleted from the calculation.
----	--

Card 4	1	2	3	4	5	6	7	8
Variable	EPS1	EPS2	EPS3	EPS4	EPS5	EPS6	EPS7	EPS8
Type	F	F	F	F	F	F	F	F
Default	0.0	0.0	0.0	0.0	0.0	0.0	0.0	0.0

VARIABLE

DESCRIPTION

EPS1 - EPS8 Effective plastic strain values (optional if SIGY is defined). At least 2 points should be defined.

Card 5	1	2	3	4	5	6	7	8
Variable	ES1	ES2	ES3	ES4	ES5	ES6	ES7	ES8
Type	F	F	F	F	F	F	F	F
Default	0.0	0.0	0.0	0.0	0.0	0.0	0.0	0.0

VARIABLE

DESCRIPTION

ES1 - ES8 Corresponding yield stress values to EPS1 - EPS8.

Remarks:

By defining the tangent modulus (ETAN), the stress-strain behavior becomes a bilinear curve. Alternately, a curve similar to that shown in [Figure M10-1](#) is expected to be defined by (EPS1, ES1) - (EPS8, ES8); however, an effective stress as a function of effective plastic strain curve ID (LCSS) may be input instead if eight points are insufficient. The cost is roughly the same for either approach. The most general approach is to use the table definition with table ID, LCSS, discussed below.

Three options to account for strain rate effects are possible.

1. Strain rate may be accounted for using the Cowper and Symonds model which scales the yield stress with the factor

$$1 + \left(\frac{\dot{\epsilon}}{C}\right)^{1/p},$$

where $\dot{\epsilon}$ is the strain rate, $\dot{\epsilon} = \sqrt{\dot{\epsilon}_{ij}\dot{\epsilon}_{ij}}$.

2. For complete generality a load curve (LCSR) to scale the yield stress may be input instead. In this curve the scale factor as a function of strain rate is defined.
3. If different stress as a function of strain curves can be provided for various strain rates, the option using the reference to a table (LCSS) can be used. Then the table input in *DEFINE_TABLE must be used; see [Figure M24-1](#)

A fully viscoplastic formulation is used in this model.

*MAT_ELASTIC_VISCOPLASTIC_THERMAL

This is Material Type 106. This is an elastic viscoplastic material with thermal effects.

Card 1	1	2	3	4	5	6	7	8
Variable	MID	RO	E	PR	SIGY	ALPHA	LCSS	FAIL
Type	A	F	F	F	F	F	F	F

Card 2	1	2	3	4	5	6	7	8
Variable	QR1	CR1	QR2	CR2	QX1	CX1	QX2	CX2
Type	F	F	F	F	F	F	F	F

Card 3	1	2	3	4	5	6	7	8
Variable	C	P	LCE	LCPR	LCSIGY	LCR	LCX	LCALPH
Type	F	F	F	F	F	F	F	F

Card 4	1	2	3	4	5	6	7	8
Variable	LCC	LCP	TREF	LCFAIL	NUSHIS	T1PHAS	T2PHAS	TOL
Type	F	F	F	F	F	F	F	F

User History Card. Additional card only for NUHIS.gt.0.

Card 6	1	2	3	4	5	6	7	8
Variable	FUSHI1	FUSHI 2	FUSHI 3	FUSHI 4	FUSHI 5	FUSHI 6	FUSHI 7	FUSHI 8
Type	I	I	I	I	I	I	I	I

VARIABLE	DESCRIPTION
MID	Material identification. A unique number or label must be specified (see *PART).
RO	Mass density
E	Young's modulus
PR	Poisson's ratio
SIGY	Initial yield stress
LCSS	Load curve ID or Table ID. The load curve ID defines effective stress as a function of effective plastic strain. The table ID defines for each temperature value a load curve ID giving the stress as a function of effective plastic strain for that temperature (*DEFINE_TABLE) or it defines for each temperature value a table ID which defines for each strain rate a load curve ID giving the stress as a function of effective plastic strain (*DEFINE_TABLE_3D). The stress as a function of effective plastic strain curve for the lowest value of temperature or strain rate is used if the temperature or strain rate falls below the minimum value. Likewise, maximum values cannot be exceeded. See Remark 1 .
FAIL	Effective plastic failure strain for erosion
ALPHA	Coefficient of thermal expansion
QR1	Isotropic hardening parameter, Q_{r1}
CR1	Isotropic hardening parameter, C_{r1}
QR2	Isotropic hardening parameter, Q_{r2}
CR2	Isotropic hardening parameter, C_{r2}
QX1	Kinematic hardening parameter, $Q_{\chi1}$
CX1	Kinematic hardening parameter, $C_{\chi1}$
QX2	Kinematic hardening parameter, $Q_{\chi2}$
CX2	Kinematic hardening parameter, $C_{\chi2}$
C	Viscous material parameter, C
P	Viscous material parameter, p

VARIABLE	DESCRIPTION
LCE	Load curve defining Young's modulus as a function of temperature. E on Card 1 is ignored with this option.
LCPR	Load curve defining Poisson's ratio as a function of temperature. PR on Card 1 is ignored with this option.
LCSIGY	Load curve defining the initial yield stress as a function of temperature. SIGY on Card 1 is ignored with this option.
LCR	Load curve for scaling the isotropic hardening parameters QR1 and QR2 or the stress given by the load curve LCSS as a function of temperature
LCX	Load curve for scaling the kinematic hardening parameters QX1 and QX2 as a function of temperature
LCALPH	<p>Load curve ID defining the instantaneous coefficient of thermal expansion as a function of temperature:</p> $d\varepsilon_{ij}^{\text{thermal}} = \alpha(T)dT\delta_{ij}.$ <p>ALPHA on Card 1 is ignored with this option. If LCALPH is defined as the negative of the load curve ID, the curve is assumed to define the coefficient relative to a reference temperature, TREF below, such that the total thermal strain is given by</p> $\varepsilon_{ij}^{\text{thermal}} = [\alpha(T)(T - T_{\text{ref}}) - \alpha(T_0)(T_0 - T_{\text{ref}})]\delta_{ij}.$ <p>Here, temperature T_0 is the initial temperature.</p>
LCC	Load curve for scaling the viscous material parameter C as a function of temperature. See Remark 1 .
LCP	Load curve for scaling the viscous material parameter P as a function of temperature
TREF	Reference temperature required if and only if LCALPH is given with a negative curve ID
LCFAIL	Load curve defining the plastic failure strain as a function of temperature. FAIL on Card 1 is ignored with this option.
NUHIS	Number of additional user defined history variables. See Remarks 2 and 3 .
T1PHAS	Lower temperature limit for cooling rate evaluation. Cooling rate can be used as input for user defined variables.

VARIABLE	DESCRIPTION
T2PHAS	Upper temperature limit for cooling rate evaluation. Cooling rate can be used as input for user defined variables.
TOL	Optional tolerance for plasticity update. The default is 10^{-6} for solid elements and 10^{-3} for shells. This parameter overrides the default tolerance for all element types.
FUSH <i>i</i>	Function ID for user defined history variables. See Remarks 2 and 3 .

Remarks:

- Viscous Effects.** If LCSS is not given any value, the uniaxial stress-strain curve has the form:

$$\sigma(\varepsilon_{\text{eff}}^p) = \sigma_0 + Q_{r1}[1 - \exp(-C_{r1}\varepsilon_{\text{eff}}^p)] + Q_{r2}[1 - \exp(-C_{r2}\varepsilon_{\text{eff}}^p)] + Q_{\chi1}[1 - \exp(-C_{\chi1}\varepsilon_{\text{eff}}^p)] + Q_{\chi2}[1 - \exp(-C_{\chi2}\varepsilon_{\text{eff}}^p)] .$$

Viscous effects are accounted for using the Cowper and Symonds model, which scales the yield stress with the factor:

$$1 + \left(\frac{\dot{\varepsilon}_{\text{eff}}^p}{C}\right)^{1/p} .$$

- User-defined history data.** The user can define up to eight additional history variables that are added to the list of history variables (see table in [Remark 3](#)). These values can for example be used to evaluate the hardness of the material.

The additional variables are to be given by respective *DEFINE_FUNCTION keywords as functions of the cooling rate between T2PHASE and T1PHASE, temperature, time, user-defined histories themselves, equivalent plastic strain, rate of the equivalent plastic strain, and the first six history variables (see table in [Remark 3](#)). A function declaration should, thus, look as follows:

```
*DEFINE_FUNCTION
1,user_defined history 1
uhist(temp,time,usrhst1,usrhst2,...,usrhstn,epspl,
epsplrate,hist2,hist3,...,hist6) = ...
```

- History Values.** The most important history variables of this material model are listed in the following table. To be able to post-process that data, parameters NEIPS (shells) or NEIPH (solids) must be defined on *DATABASE_EXTENT_BINARY.

History Variable #	Description
1	Temperature
2	Young's modulus
3	Poisson's ratio
4	Yield stress
5	Isotropic scaling factor
6	Kinematic scaling factor
9	Effective plastic strain rate
10→ 9+NUSHIS	User defined history variables

***MAT_MODIFIED_JOHNSON_COOK**

This is Material Type 107. Adiabatic heating is included in the material formulation. Material type 107 is not intended for use in a coupled thermal-mechanical analysis or in a mechanical analysis where temperature is prescribed using *LOAD_THERMAL.

Card Summary:

Card 1. This card is required.

MID	RO	E	PR	BETA	XS1	CP	ALPHA
-----	----	---	----	------	-----	----	-------

Card 2. This card is required.

EODOT	TR	TM	T0	FLAG1	FLAG2		
-------	----	----	----	-------	-------	--	--

Card 3a.1. This card is included if FLAG1 = 0.

A	B	N	C	M			
---	---	---	---	---	--	--	--

Card 3a.2. This card is included if FLAG1 = 0.

Q1	C1	Q2	C2				
----	----	----	----	--	--	--	--

Card 3b.1. This card is included if FLAG1 = 1.

SIGA	B	BETA0	BETA1				
------	---	-------	-------	--	--	--	--

Card 3b.2. This card is included if FLAG1 = 1.

A	N	ALPHA0	ALPHA1				
---	---	--------	--------	--	--	--	--

Card 4a. This card is included if FLAG2 = 0.

DC	PD	D1	D2	D3	D4	D5	
----	----	----	----	----	----	----	--

Card 4b. This card is included if FLAG2 = 1.

DC	WC	PHI	GAMMA				
----	----	-----	-------	--	--	--	--

Card 5. This card is required.

TC	TAUC						
----	------	--	--	--	--	--	--

Data Card Definitions:

Card 1	1	2	3	4	5	6	7	8
Variable	MID	RO	E	PR	BETA	XS1	CP	ALPHA
Type	A	F	F	F	F	F	F	F

VARIABLE**DESCRIPTION**

MID	Material identification. A unique number or label must be specified (see *PART).
RO	Mass density
E	Young's modulus, E
PR	Poisson's ratio, ν
BETA	Damage coupling parameter; see Equation (107.3) . EQ.0.0: No coupling between ductile damage and the constitutive relation EQ.1.0: Full coupling between ductile damage and the constitutive relation
XS1	Taylor-Quinney coefficient χ , see Equation (107.21) . Gives the portion of plastic work converted into heat (normally taken to be 0.9)
CP	Specific heat C_p ; see Equation (107.21) .
ALPHA	Thermal expansion coefficient, α

Card 2	1	2	3	4	5	6	7	8
Variable	E0DOT	TR	TM	T0	FLAG1	FLAG2		
Type	F	F	F	F	I	I		

VARIABLE**DESCRIPTION**

E0DOT	Quasi-static threshold strain rate ($\dot{\epsilon}_0 = \dot{p}_0 = \dot{r}_0$); see Equation (107.12) . See description for EPS0 in *MAT_015.
-------	--

VARIABLE	DESCRIPTION
TR	Room temperature, see Equation (107.13)
TM	Melt temperature, see Equation (107.13)
T0	Initial temperature
FLAG1	Constitutive relation flag: EQ.0: Modified Johnson-Cook constitutive relation; see Equation (107.11) . EQ.1: Zerilli-Armstrong constitutive relation, see Equation (107.14) .
FLAG2	Fracture criterion flag: EQ.0: Modified Johnson-Cook fracture criterion; see Equation (107.15) . EQ.1: Cockcroft-Latham fracture criterion; see Equation (107.19) .

Modified Johnson-Cook Constitutive Relation. This card is included when FLAG1 = 0.

Card 3a.1	1	2	3	4	5	6	7	8
Variable	A	B	N	C	M			
Type	F	F	F	F	F			

VARIABLE	DESCRIPTION
A	Johnson-Cook yield stress A ; see Equation (107.11) .
B	Johnson-Cook hardening parameter B ; see Equation (107.11) .
N	Johnson-Cook hardening parameter n ; see Equation (107.11) .
C	Johnson-Cook strain rate sensitivity parameter C ; see Equation (107.11) .
M	Johnson-Cook thermal softening parameter m ; see Equation (107.11) .

Modified Johnson-Cook Constitutive Relation. This card is included when FLAG1 = 0.

Card 3a.2	1	2	3	4	5	6	7	8
Variable	Q1	C1	Q2	C2				
Type	F	F	F	F				

VARIABLE**DESCRIPTION**

Q1	Voce hardening parameter Q_1 (when $B = n = 0$); see Equation (107.11) .
C1	Voce hardening parameter C_1 (when $B = n = 0$); see Equation (107.11) .
Q2	Voce hardening parameter Q_2 (when $B = n = 0$); see Equation (107.11) .
C2	Voce hardening parameter C_2 (when $B = n = 0$); see Equation (107.11) .

Modified Zerilli-Armstrong Constitutive Relation. This card is included when FLAG1 = 1.

Card 3b.1	1	2	3	4	5	6	7	8
Variable	SIGA	B	BETA0	BETA1				
Type	F	F	F	F				

VARIABLE**DESCRIPTION**

SIGA	Zerilli-Armstrong parameter α_a ; see Equation (107.14) .
B	Zerilli-Armstrong parameter B ; see Equation (107.14) .
BETA0	Zerilli-Armstrong parameter β_0 ; see Equation (107.14) .
BETA1	Zerilli-Armstrong parameter β_1 ; see Equation (107.14) .

Modified Zerilli-Armstrong Constitutive Relation. This card is included when FLAG1 = 1.

Card 3b.2	1	2	3	4	5	6	7	8
Variable	A	N	ALPHA0	ALPHA1				
Type	F	F	F	F				

VARIABLE**DESCRIPTION**

A	Zerilli-Armstrong parameter A ; see Equation (107.14) .
N	Zerilli-Armstrong parameter n ; see Equation (107.14) .
ALPHA0	Zerilli-Armstrong parameter α_0 , see Equation (107.14) .
ALPHA1	Zerilli-Armstrong parameter α_1 , see Equation (107.14) .

Modified Johnson-Cook Fracture Criterion. This card is included when FLAG2 = 0.

Card 4a	1	2	3	4	5	6	7	8
Variable	DC	PD	D1	D2	D3	D4	D5	
Type	F	F	F	F	F	F	F	

VARIABLE**DESCRIPTION**

DC	Critical damage parameter D_c ; see Equations (107.15) and (107.22) . When the damage value D reaches this value, the element is eroded from the calculation.
PD	Damage threshold; see Equation (107.15) .
D1-D5	Fracture parameters in the Johnson-Cook fracture criterion; see Equation (107.16) .

Cockcroft Latham Fracture Criterion. This card is included when FLAG2 = 1.

Card 4b	1	2	3	4	5	6	7	8
Variable	DC	WC	PHI	GAMMA				
Type	F	F	F	F				

VARIABLE**DESCRIPTION**

DC Critical damage parameter D_c ; see [Equations \(107.15\)](#) and [\(107.22\)](#). When the damage value D reaches this value, the element is eroded from the calculation.

WC Critical Cockcroft-Latham parameter W_c , see [Equation \(107.19\)](#). When the plastic work per volume reaches this value, the element is eroded from the simulation.

PHI Extended Cockcroft-Latham parameter ϕ , see [Equation \(107.20\)](#).

GAMMA Extended Cockcroft-Latham parameter γ , see [Equation \(107.20\)](#).

Additional Element Erosion Criteria Card.

Card 5	1	2	3	4	5	6	7	8
Variable	TC	TAUC						
Type	F	F						

VARIABLE**DESCRIPTION**

TC Critical temperature parameter T_c ; see [Equation \(107.24\)](#). When the temperature, T , reaches this value, the element is eroded from the simulation.

TAUC Critical shear stress parameter, τ_c . When the maximum shear stress, τ , reaches this value, the element is eroded from the simulation.

Remarks:

An additive decomposition of the rate-of-deformation tensor \mathbf{d} is assumed, that is,

$$\mathbf{d} = \mathbf{d}^e + \mathbf{d}^p + \mathbf{d}^t \quad (107.1)$$

where \mathbf{d}^e is the elastic part, \mathbf{d}^p is the plastic part and \mathbf{d}^t is the thermal part.

The elastic rate-of-deformation \mathbf{d}^e is defined by a linear hypo-elastic relation

$$\tilde{\sigma}^{\nabla J} = \left(K - \frac{2}{3}G \right) \text{tr}(\mathbf{d}^e)\mathbf{I} + 2G\mathbf{d}^e \quad (107.2)$$

where \mathbf{I} is the unit tensor, K is the bulk modulus and G is the shear modulus. The effective stress tensor is defined by

$$\tilde{\sigma} = \frac{\sigma}{1 - \beta D} \quad (107.3)$$

where σ is the Cauchy-stress and D is the damage variable, while the Jaumann rate of the effective stress reads

$$\tilde{\sigma}^{\nabla J} = \dot{\tilde{\sigma}} - \mathbf{W} \cdot \tilde{\sigma} - \tilde{\sigma} \cdot \mathbf{W}^T \quad (107.4)$$

Here \mathbf{W} is the spin tensor. The parameter β is equal to unity for coupled damage and equal to zero for uncoupled damage.

The thermal rate-of-deformation \mathbf{d}^T is defined by

$$\mathbf{d}^T = \alpha \dot{T} \mathbf{I} \quad (107.5)$$

where α is the linear thermal expansion coefficient and T is the temperature.

The plastic rate-of-deformation is defined by the associated flow rule as

$$\mathbf{d}^p = \dot{r} \frac{\partial f}{\partial \sigma} = \frac{3}{2} \frac{\dot{r}}{1 - \beta D} \frac{\tilde{\sigma}'}{\tilde{\sigma}_{\text{eq}}} \quad (107.6)$$

where $(\cdot)'$ means the deviatoric part of the tensor, r is the damage-equivalent plastic strain, f is the dynamic yield function, that is,

$$\mathbf{d}^p = \dot{r} \frac{\partial f}{\partial \sigma} = \frac{3}{2} \frac{\dot{r}}{1 - \beta D} \frac{\tilde{\sigma}'}{\tilde{\sigma}_{\text{eq}}} \quad (107.6)$$

$$f = \sqrt{\frac{3}{2} \tilde{\sigma}' : \tilde{\sigma}'} - \sigma_Y(r, \dot{r}, T) \leq 0, \quad \dot{r} \geq 0, \quad \dot{r} f = 0 \quad (107.7)$$

and $\tilde{\sigma}_{\text{eq}}$ is the damage-equivalent stress,

$$\tilde{\sigma}_{\text{eq}} = \sqrt{\frac{3}{2} \tilde{\sigma}' : \tilde{\sigma}'} \quad (107.8)$$

The following plastic work conjugate pairs are identified

$$\dot{W}^p = \sigma : \mathbf{d}^p = \tilde{\sigma}_{\text{eq}} \dot{r} = \sigma_{\text{eq}} \dot{p} \quad (107.9)$$

where \dot{W}^p is the specific plastic work rate, and the equivalent stress σ_{eq} and the equivalent plastic strain p are defined as

$$\sigma_{\text{eq}} = \sqrt{\frac{3}{2} \tilde{\sigma}' : \tilde{\sigma}'} = (1 - \beta D) \tilde{\sigma}_{\text{eq}} \quad \dot{p} = \sqrt{\frac{2}{3} \mathbf{d}^p : \mathbf{d}^p} = \frac{\dot{\epsilon}}{(1 - \beta D)} \quad (107.10)$$

The material strength σ_Y is defined by:

1. The modified Johnson-Cook constitutive relation

$$\sigma_Y = \left\{ A + Br^n + \sum_{i=1}^2 Q_i [1 - \exp(-C_i r)] \right\} (1 + \dot{\epsilon}^*)^C (1 - T^{*m}) \quad (107.11)$$

where $A, B, C, m, n, Q_1, C_1, Q_2,$ and C_2 are material parameters; the normalized damage-equivalent plastic strain rate $\dot{\epsilon}^*$ is defined by

$$\dot{\epsilon}^* = \frac{\dot{\epsilon}}{\dot{\epsilon}_0} \quad (107.12)$$

in which $\dot{\epsilon}_0$ is a user-defined reference strain rate; and the homologous temperature reads

$$T^* = \frac{T - T_r}{T_m - T_r} \quad (107.13)$$

in which T_r is the room temperature and T_m is the melting temperature.

2. The Zerilli-Armstrong constitutive relation

$$\sigma_Y = \{ \sigma_a + B \exp[-(\beta_0 - \beta_1 \ln \dot{\epsilon}) T] + A r^n \exp[-(\alpha_0 - \alpha_1 \ln \dot{\epsilon}) T] \} \quad (107.14)$$

where $\sigma_a, B, \beta_0, \beta_1, A, n, \alpha_0,$ and α_1 are material parameters.

Damage evolution is defined by:

1. The extended Johnson-Cook damage evolution rule:

$$\Delta D = \begin{cases} 0 & p \leq p_d \\ \frac{D_c \Delta p}{p_f - p_d} & p > p_d \end{cases} \quad (107.15)$$

where the current equivalent fracture strain $p_f = p_f(\sigma^*, \Delta p^*, T^*)$ is defined as

$$p_f = [D_1 + D_2 \exp(D_3 \sigma^*)] (1 + \Delta p^*)^{D_4} (1 + D_5 T^*) \quad (107.16)$$

Here $D_1, D_2, D_3, D_4, D_5, D_c,$ and p_d are material parameters. The normalized equivalent plastic strain increment Δp^* is defined by

$$\Delta p^* = \frac{\Delta p}{\dot{\epsilon}_0} \quad (107.17)$$

and the stress triaxiality σ^* reads

$$\sigma^* = \frac{\sigma_H}{\sigma_{eq}}, \quad \sigma_H = \frac{1}{3} tr(\sigma) \tag{107.18}$$

2.The Cockcroft-Latham damage evolution rule:

$$\Delta D = \frac{D_C}{W_C} \max(\sigma_1, 0) \Delta p \tag{107.19}$$

where D_C and W_C are material parameters. This assumes that the material parameters ϕ or γ are zero. If they are not, the uncoupled extended Cockcroft-Latham damage evolution rule is used:

$$\Delta D = \frac{\sigma_{eq}}{W_C} \max\left(\phi \frac{\sigma_1}{\sigma_{eq}} + (1 - \phi) \frac{\sigma_1 - \sigma_3}{\sigma_{eq}}, 0\right)^\gamma \Delta p \tag{107.20}$$

Adiabatic heating is calculated as

$$\dot{T} = \chi \frac{\sigma : \mathbf{d}^p}{\rho C_p} = \chi \frac{\tilde{\sigma}_{eq} \dot{\epsilon}}{\rho C_p} \tag{107.21}$$

where χ is the Taylor-Quinney parameter, ρ is the density and C_p is the specific heat. The initial value of the temperature T_0 may be specified by the user.

Element erosion occurs when one of the following several criteria are fulfilled:

1. The damage is greater than the critical value

$$D \geq D_C \tag{107.22}$$

2. The maximum shear stress is greater than a critical value

$$\tau_{max} = \frac{1}{2} \max\{|\sigma_1 - \sigma_2|, |\sigma_2 - \sigma_3|, |\sigma_3 - \sigma_1|\} \geq \tau_C \tag{107.23}$$

3. The temperature is greater than a critical value

$$T \geq T_C \tag{107.24}$$

History Variable	Description
1	Evaluation of damage D
2	Evaluation of stress triaxiality σ^*
3	Evaluation of damaged plastic strain r
4	Evaluation of temperature T
5	Evaluation of damaged plastic strain rate \dot{r}

History Variable	Description
8	Evaluation of plastic work per volume W
9	Evaluation of maximum shear stress τ_{\max}

***MAT_ORTHO_ELASTIC_PLASTIC**

This is Material Type 108. This model combines orthotropic elastic plastic behavior with an anisotropic yield criterion. This model is implemented only for shell elements.

Card Summary:

Card 1. This card is required.

MID	RO	E11	E22	G12	PR12	PR23	PR31
-----	----	-----	-----	-----	------	------	------

Card 2. This card is required.

SIGMA0	LC	QR1	CR1	QR2	CR2		
--------	----	-----	-----	-----	-----	--	--

Card 3. This card is required.

R11	R22	R33	R12				
-----	-----	-----	-----	--	--	--	--

Card 4. This card is required.

AOPT	BETA						
------	------	--	--	--	--	--	--

Card 5. This card is required.

			A1	A2	A3		
--	--	--	----	----	----	--	--

Card 6. This card is required.

V1	V2	V3	D17	D2	D3		
----	----	----	-----	----	----	--	--

Data Card Definitions:

Card 1	1	2	3	4	5	6	7	8
Variable	MID	RO	E11	E22	G12	PR12	PR23	PR31
Type	A	F	F	F	F	F	F	F

VARIABLE

DESCRIPTION

MID

Material identification. A unique number or label must be specified (see *PART).

VARIABLE	DESCRIPTION
RO	Mass density
E11	Young's modulus in 11-direction
E22	Young's modulus in 22-direction
G12	Shear modulus in 12-direction
PR12	Poisson's ratio 12
PR23	Poisson's ratio 23
PR31	Poisson's ratio 31

Card 2	1	2	3	4	5	6	7	8
Variable	SIGMA0	LC	QR1	CR1	QR2	CR2		
Type	F	I	F	F	F	F		

VARIABLE	DESCRIPTION
SIGMA0	Initial yield stress, σ_0
LC	Load curve defining effective stress as a function of effective plastic strain. If defined, QR1, CR1, QR2, and CR2 are ignored.
QR1	Isotropic hardening parameter, Q_{R1}
CR1	Isotropic hardening parameter, C_{R1}
QR2	Isotropic hardening parameter, Q_{R2}
CR2	Isotropic hardening parameter, C_{R2}

Card 3	1	2	3	4	5	6	7	8
Variable	R11	R22	R33	R12				
Type	F	F	F	F				

VARIABLE	DESCRIPTION
R11	Yield criteria parameter, R_{11}
R22	Yield criteria parameter, R_{22}
R33	Yield criteria parameter, R_{33}
R12	Yield criteria parameter, R_{12}

Card 4	1	2	3	4	5	6	7	8
Variable	AOPT	BETA						
Type	F	F						

VARIABLE	DESCRIPTION
AOPT	<p>Material axes option (see <code>MAT_OPTIONTROPIC_ELASTIC</code> for a more complete description):</p> <p>EQ.0.0: Locally orthotropic with material axes determined by element nodes as shown in Figure M2-1. Nodes 1, 2 and 4 of an element are identical to the node used for the definition of a coordinate system as by <code>*DEFINE_COORDINATE_NODES</code>, and then rotated about the shell element normal by an angle BETA</p> <p>EQ.2.0: Globally orthotropic with material axes determined by vectors defined below, as with <code>*DEFINE_COORDINATE_VECTOR</code></p> <p>EQ.3.0: Locally orthotropic material axes determined by offsetting the material axes by an angle, BETA, from a line determined by taking the cross product of the vector \mathbf{v} with the normal to the plane of the element</p> <p>LT.0.0: The absolute value of AOPT is a coordinate system ID number (CID on <code>*DEFINE_COORDINATE_NODES</code>, <code>*DEFINE_COORDINATE_SYSTEM</code> or <code>*DEFINE_COORDINATE_VECTOR</code>). Available in R3 version of 971 and later.</p>
BETA	Material angle in degrees for AOPT = 0 and 3. BETA may be overridden on the element card; see <code>*ELEMENT_SHELL_BETA</code> .

Card 5	1	2	3	4	5	6	7	8
Variable				A1	A2	A3		
Type				F	F	F		

VARIABLE**DESCRIPTION**

A1, A2, A3

Components of vector **a** for AOPT = 2

Card 6	1	2	3	4	5	6	7	8
Variable	V1	V2	V3	D1	D2	D3		
Type	F	F	F	F	F	F		

VARIABLE**DESCRIPTION**

V1, V2, V3

Components of vector **v** for AOPT = 3

D1, D2, D3

Components of vector **d** for AOPT = 2**Remarks:**

The yield function is defined as

$$f = \bar{f}(\sigma) - [\sigma_0 + R(\varepsilon^p)] ,$$

where the equivalent stress σ_{eq} is defined as an anisotropic yield criterion

$$\sigma_{eq} = \sqrt{F(\sigma_{22} - \sigma_{33})^2 + G(\sigma_{33} - \sigma_{11})^2 + H(\sigma_{11} - \sigma_{22})^2 + 2L\sigma_{23}^2 + 2M\sigma_{31}^2 + 2N\sigma_{12}^2} .$$

Here F, G, H, L, M and N are constants obtained by testing the material in different orientations. They are defined as

$$\begin{aligned} F &= \frac{1}{2} \left(\frac{1}{R_{22}^2} + \frac{1}{R_{33}^2} - \frac{1}{R_{11}^2} \right), & L &= \frac{3}{2R_{23}^2} \\ G &= \frac{1}{2} \left(\frac{1}{R_{33}^2} + \frac{1}{R_{11}^2} - \frac{1}{R_{22}^2} \right), & M &= \frac{3}{2R_{31}^2} \\ H &= \frac{1}{2} \left(\frac{1}{R_{11}^2} + \frac{1}{R_{22}^2} - \frac{1}{R_{33}^2} \right), & N &= \frac{3}{2R_{12}^2} \end{aligned}$$

The yield stress ratios are defined as follows

$$\begin{aligned} R_{11} &= \frac{\bar{\sigma}_{11}}{\sigma_0}, & R_{12} &= \frac{\bar{\sigma}_{12}}{\tau_0} \\ R_{22} &= \frac{\bar{\sigma}_{22}}{\sigma_0}, & R_{23} &= \frac{\bar{\sigma}_{23}}{\tau_0} \\ R_{33} &= \frac{\bar{\sigma}_{33}}{\sigma_0}, & R_{31} &= \frac{\bar{\sigma}_{31}}{\tau_0} \end{aligned}$$

where σ_{ij} is the measured yield stress values, σ_0 is the reference yield stress, and $\tau_0 = \sigma_0/\sqrt{3}$.

The strain hardening, R , is either defined by the load curve or by the extended Voce law,

$$R(\varepsilon^p) = \sum_{i=1}^2 Q_{Ri} [1 - \exp(-C_{Ri}\varepsilon^p)] ,$$

where ε^p is the effective (or accumulated) plastic strain, and Q_{Ri} and C_{Ri} are strain hardening parameters.

***MAT_JOHNSON_HOLMQUIST_CERAMICS**

This is Material Type 110. This Johnson-Holmquist Plasticity Damage Model is useful for modeling ceramics, glass and other brittle materials. A more detailed description can be found in a paper by Johnson and Holmquist [1993].

Card 1	1	2	3	4	5	6	7	8
Variable	MID	RO	G	A	B	C	M	N
Type	A	F	F	F	F	F	F	F

Card 2	1	2	3	4	5	6	7	8
Variable	EPS0	T	SFMAX	HEL	PHEL	BETA		
Type	F	F	F	F	F	F		

Card 3	1	2	3	4	5	6	7	8
Variable	D1	D2	K1	K2	K3	FS		
Type	F	F	F	F	F	F		

VARIABLE**DESCRIPTION**

MID	Material identification. A unique number or label must be specified (see *PART).
RO	Density
G	Shear modulus
A	Intact normalized strength parameter
B	Fractured normalized strength parameter
C	Strength parameter (for strain rate dependence)
M	Fractured strength parameter (pressure exponent)

VARIABLE	DESCRIPTION
N	Intact strength parameter (pressure exponent)
EPS0	Quasi-static threshold strain rate. See *MAT_015.
T	Maximum tensile pressure strength
SFMAX	Maximum normalized fractured strength (defaults to 10^{20} when set to 0.0).
HEL	Hugoniot elastic limit
PHEL	Pressure component at the Hugoniot elastic limit
BETA	Fraction of elastic energy loss converted to hydrostatic energy. It affects bulking pressure (history variable 1) that accompanies damage.
D1	Parameter for plastic strain to fracture
D2	Parameter for plastic strain to fracture (exponent)
K1	First pressure coefficient (equivalent to the bulk modulus)
K2	Second pressure coefficient
K3	Third pressure coefficient
FS	Element deletion criterion: LT.0.0: Fail if $p^* + t^* < 0$ (tensile failure) EQ.0.0: No failure (default) GT.0.0: Fail if the effective plastic strain > FS

Remarks:

The equivalent stress for a ceramic-type material is given by

$$\sigma^* = \sigma_i^* - D(\sigma_i^* - \sigma_f^*) ,$$

where

$$\sigma_i^* = a(p^* + t^*)^n (1 + c \ln \dot{\epsilon}^*)$$

represents the intact, undamaged behavior. The superscript, “*”, indicates a normalized quantity. The stresses are normalized by the equivalent stress at the Hugoniot elastic limit, the pressures are normalized by the pressure at the Hugoniot elastic limit, and the

strain rate by the reference strain rate defined in the input. In this equation a is the intact normalized strength parameter, c is the strength parameter for strain rate dependence, $\dot{\varepsilon}^*$ is the normalized plastic strain rate, and

$$t^* = \frac{T}{\text{PHEL}}$$

$$p^* = \frac{p}{\text{PHEL}}$$

In the above, T is the maximum tensile pressure strength, PHEL is the pressure component at the Hugoniot elastic limit, and p is the pressure.

$$D = \sum \frac{\Delta \varepsilon^p}{\varepsilon_f^p}$$

represents the accumulated damage (history variable 2) based upon the increase in plastic strain per computational cycle and the plastic strain to fracture

$$\varepsilon_f^p = d_1 (p^* + t^*)^{d_2}$$

and

$$\sigma_f^* = b (p^*)^m (1 + c \ln \dot{\varepsilon}^*) \leq \text{SFMAX}$$

represents the damaged behavior. The parameter d_1 controls the rate at which damage accumulates. If it is set to 0, full damage occurs in one time step, that is, instantaneously. It is also the best parameter to vary when attempting to reproduce results generated by another finite element program.

In undamaged material, the hydrostatic pressure is given by

$$P = k_1 \mu + k_2 \mu^2 + k_3 \mu^3$$

in compression and

$$P = k_1 \mu$$

in tension where $\mu = \rho/\rho_0 - 1$. When damage starts to occur, there is an increase in pressure. A fraction, between 0 and 1, of the elastic energy loss, β , is converted into hydrostatic potential energy (pressure). The details of this pressure increase are given in the reference.

Given HEL and G , μ_{hel} can be found iteratively from

$$\text{HEL} = k_1 \mu_{\text{hel}} + k_2 \mu_{\text{hel}}^2 + k_3 \mu_{\text{hel}}^3 + (4/3)g(\mu_{\text{hel}}/(1 + \mu_{\text{hel}}))$$

and, subsequently, for normalization purposes,

$$P_{\text{hel}} = k_1 \mu_{\text{hel}} + k_2 \mu_{\text{hel}}^2 + k_3 \mu_{\text{hel}}^3$$

and

$$\sigma_{\text{hel}} = 1.5(\text{hel} - p_{\text{hel}}) .$$

These are calculated automatically by LS-DYNA if p_{hel} is zero on input.

*MAT_JOHNSON_HOLMQUIST_CONCRETE

This is Material Type 111. This model can be used for concrete subjected to large strains, high strain rates and high pressures. The equivalent strength is expressed as a function of the pressure, strain rate, and damage. The pressure is expressed as a function of the volumetric strain and includes the effect of permanent crushing. The damage is accumulated as a function of the plastic volumetric strain, equivalent plastic strain and pressure. A more detailed description of this model can be found in the paper by Holmquist, Johnson, and Cook [1993].

Card 1	1	2	3	4	5	6	7	8
Variable	MID	RO	G	A	B	C	N	FC
Type	A	F	F	F	F	F	F	F

Card 2	1	2	3	4	5	6	7	8
Variable	T	EPS0	EFMIN	SFMAX	PC	UC	PL	UL
Type	F	F	F	F	F	F	F	F

Card 3	1	2	3	4	5	6	7	8
Variable	D1	D2	K1	K2	K3	FS		
Type	F	F	F	F	F	F		

VARIABLE

DESCRIPTION

- MID Material identification. A unique number or label must be specified (see *PART).
- RO Mass density
- G Shear modulus
- A Normalized cohesive strength
- B Normalized pressure hardening

VARIABLE	DESCRIPTION
C	Strain rate coefficient
N	Pressure hardening exponent
FC	Quasi-static uniaxial compressive strength
T	Maximum tensile hydrostatic pressure
EPS0	Quasi-static threshold strain rate. See *MAT_015.
EFMIN	Amount of plastic strain before fracture
SFMAX	Normalized maximum strength
PC	Crushing pressure
UC	Crushing volumetric strain
PL	Locking pressure
UL	Locking volumetric strain
D1	Damage constant
D2	Damage constant
K1	Pressure constant
K2	Pressure constant
K3	Pressure constant
FS	Failure type: LT.0.0: Fail if damage strength < 0 EQ.0.0: Fail if $P^* + T^* \leq 0$ (tensile failure) GT.0.0: Fail if the effective plastic strain > FS

Remarks:

The normalized equivalent stress is defined as

$$\sigma^* = \frac{\sigma}{f'_c},$$

where σ is the actual equivalent stress, and f'_c is the quasi-static uniaxial compressive strength. The expression is defined as:

$$\sigma^* = [A(1 - D) + BP^{*N}][1 + C \ln(\dot{\epsilon}^*)] .$$

where D is the damage parameter, $P^* = P/f'_c$ is the normalized pressure and $\dot{\epsilon}^* = \dot{\epsilon}/\dot{\epsilon}_0$ is the dimensionless strain rate. The model incrementally accumulates damage, D , both from equivalent plastic strain and plastic volumetric strain, and is expressed as

$$D = \sum \frac{\Delta \epsilon_p + \Delta \mu_p}{D_1(P^* + T^*)^{D_2}} .$$

Here, $\Delta \epsilon_p$ and $\Delta \mu_p$ are the equivalent plastic strain and plastic volumetric strain, D_1 and D_2 are material constants and $T^* = T/f'_c$ is the normalized maximum tensile hydrostatic pressure.

The damage strength, DS, is defined in compression when $P^* > 0$ as

$$DS = f'_c \min[SFMAX, A(1 - D) + BP^{*N}][1 + C * \ln(\dot{\epsilon}^*)]$$

or in tension if $P^* < 0$, as

$$DS = f'_c \max \left[0, A(1 - D) - A \left(\frac{P^*}{T} \right) \right] [1 + C * \ln(\dot{\epsilon}^*)] .$$

The pressure for fully dense material is expressed as

$$P = K_1 \bar{\mu} + K_2 \bar{\mu}^2 + K_3 \bar{\mu}^3 ,$$

where K_1 , K_2 and K_3 are material constants and the modified volumetric strain is defined as

$$\bar{\mu} = \frac{\mu - \mu_{\text{lock}}}{1 + \mu_{\text{lock}}} ,$$

where μ_{lock} is the locking volumetric strain.

*MAT_112

*MAT_FINITE_ELASTIC_STRAIN_PLASTICITY

*MAT_FINITE_ELASTIC_STRAIN_PLASTICITY

This is Material Type 112. An elasto-plastic material with an arbitrary stress versus strain curve and arbitrary strain rate dependency can be defined. The elastic response of this model uses a finite strain formulation so that large elastic strains can develop before yielding occurs. This model is available for solid elements only. See Remarks below.

Card 1	1	2	3	4	5	6	7	8
Variable	MID	RO	E	PR	SIGY	ETAN		
Type	A	F	F	F	F	F		
Default	none	none	none	none	none	0.0		

Card 2	1	2	3	4	5	6	7	8
Variable	C	P	LCSS	LCSR				
Type	F	F	I	I				
Default	0.0	0.0	0	0				

Card 3	1	2	3	4	5	6	7	8
Variable	EPS1	EPS2	EPS3	EPS4	EPS5	EPS6	EPS7	EPS8
Type	F	F	F	F	F	F	F	F
Default	0.0	0.0	0.0	0.0	0.0	0.0	0.0	0.0

Card 4	1	2	3	4	5	6	7	8
Variable	ES1	ES2	ES3	ES4	ES5	ES6	ES7	ES8
Type	F	F	F	F	F	F	F	F
Default	0.0	0.0	0.0	0.0	0.0	0.0	0.0	0.0

VARIABLE**DESCRIPTION**

MID	Material identification. A unique number or label must be specified (see *PART).
RO	Mass density
E	Young's modulus
PR	Poisson's ratio
SIGY	Yield stress
ETAN	Tangent modulus; ignored if LCSS > 0
C	Strain rate parameter, C ; see Remarks below.
P	Strain rate parameter, p ; see Remarks below.
LCSS	Load curve ID or table ID. Load Curve ID. The load curve defines effective stress as a function of effective plastic strain. If defined, EPS1 - EPS8 and ES1 - ES8 are ignored. Table ID. The table defines for each strain rate value a load curve ID giving the stress as a function of effective plastic strain for that rate; see Figure M24-1 . The stress as a function of effective plastic strain curve for the lowest value of strain rate is used if the strain rate falls below the minimum value. Likewise, the stress as a function of effective plastic strain curve for the highest value of strain rate is used if the strain rate exceeds the maximum value. The strain rate parameters, C and p ; the curve ID LCSR; EPS1 - EPS8; and ES1 - ES8 are ignored if a table ID is defined.
LCSR	Load curve ID defining strain rate scaling effect on yield stress

VARIABLE	DESCRIPTION
EPS1 - EPS8	Effective plastic strain values (optional if SIGY is defined). At least 2 points should be defined. The first point must be zero corresponding to the initial yield stress. WARNING: If the first point is nonzero, the yield stress is extrapolated to determine the initial yield. If this option is used, SIGY and ETAN are ignored and may be input as zero.
ES1 - ES8	Corresponding yield stress values to EPS1 - EPS8.

Remarks:

By defining the tangent modulus ETAN, the stress strain behavior is treated using a bi-linear stress strain curve. Alternately, a curve similar to that shown in [Figure M10-1](#) is expected to be defined by (EPS1, ES1) - (EPS8, ES8); however, an effective stress as a function of effective plastic strain curve (LCSS) may be input instead if eight points are insufficient. The cost is roughly the same for either approach. The most general approach is to use the table definition (LCSS) discussed below.

Three options to account for strain rate effects are possible.

1. Strain rate may be accounted for using the Cowper and Symonds model which scales the yield stress with the factor

$$1 + \left(\frac{\dot{\epsilon}}{C} \right)^{1/p},$$

where $\dot{\epsilon}$ is the strain rate, $\dot{\epsilon} = \sqrt{\dot{\epsilon}_{ij}\dot{\epsilon}_{ij}}$.

2. For complete generality a load curve (LCSR) to scale the yield stress may be input instead. In this curve the scale factor as a function of strain rate is defined.
3. If different stress as a function of strain curves can be provided for various strain rates, the option using the reference to a table (LCSS) can be used. Then the table input in *DEFINE_TABLE must be used; see [Figure M24-1](#).

***MAT_TRIP**

This is Material Type 113. This isotropic elasto-plastic material model applies to shell elements only. It features a special hardening law aimed at modelling the temperature dependent hardening behavior of austenitic stainless TRIP-steels. TRIP stands for Transformation Induced Plasticity. A detailed description of this material model can be found in Hänsel, Hora, and Reissner [1998] and Schedin, Prentzas, and Hilding [2004].

Card 1	1	2	3	4	5	6	7	8
Variable	MID	RO	E	PR	CP	T0	TREF	TA0
Type	A	F	F	F	F	F	F	F

Card 2	1	2	3	4	5	6	7	8
Variable	A	B	C	D	P	Q	EOMART	VMO
Type	F	F	F	F	F	F	F	F

Card 3	1	2	3	4	5	6	7	8
Variable	AHS	BHS	M	N	EPS0	HMART	K1	K2
Type	F	F	F	F	F	F	F	F

VARIABLE**DESCRIPTION**

MID	Material identification. A unique number or label must be specified (see *PART).
RO	Mass density
E	Young's modulus
PR	Poisson's ratio
CP	Adiabatic temperature calculation option: EQ.0.0: Adiabatic temperature calculation is disabled.

VARIABLE	DESCRIPTION
	GT.0.0: CP is the specific heat C_p . Adiabatic temperature calculation is enabled.
T0	Initial temperature T_0 of the material if adiabatic temperature calculation is enabled.
TREF	Reference temperature for output of the yield stress as history variable 1.
TA0	Reference temperature T_{A0} , the absolute zero for the used temperature scale. For example, TA0 is -273.15 if the Celsius scale is used and 0.0 if the Kelvin scale is used.
A	Martensite rate equation parameter A ; see Remarks below.
B	Martensite rate equation parameter B ; see Remarks below.
C	Martensite rate equation parameter C ; see Remarks below.
D	Martensite rate equation parameter D ; see Remarks below.
P	Martensite rate equation parameter p ; see Remarks below.
Q	Martensite rate equation parameter Q ; see Remarks below.
E0MART	Martensite rate equation parameter $E_{0(\text{mart})}$; see Remarks below.
VM0	The initial volume fraction of martensite $0.0 < V_{m0} < 1.0$ may be initialised using two different methods: GT.0.0: V_{m0} is set to VM0. LT.0.0: Can be used only when there are initial plastic strains ϵ^p present, such as when using *INITIAL_STRESS_SHELL. The absolute value of VM0 is then the load curve ID for a function f that sets $V_{m0} = f(\epsilon^p)$. The function f must be a monotonically nondecreasing function of ϵ^p .
AHS	Hardening law parameter A_{HS} ; see Remarks below.
BHS	Hardening law parameter B_{HS} ; see Remarks below.
M	Hardening law parameter m ; see Remarks below.
N	Hardening law parameter n ; see Remarks below.

VARIABLE	DESCRIPTION
EPS0	Hardening law parameter ε_0 ; see Remarks below.
HMART	Hardening law parameter $\Delta H_{\gamma \rightarrow \alpha'}$; see Remarks below.
K1	Hardening law parameter K_1 ; see Remarks below.
K2	Hardening law parameter K_2 ; see Remarks below.

Remarks:

Here a short description is given of the TRIP-material model. The material model uses the von Mises yield surface in combination with isotropic hardening. The hardening is temperature dependent. Therefore, this material model must be run either in a coupled thermo-mechanical solution, using prescribed temperatures or using the adiabatic temperature calculation option. Setting the parameter CP to the specific heat, C_p , of the material activates the adiabatic temperature calculation that calculates the temperature rate from the equation

$$\dot{T} = \sum_{i,j} \frac{\sigma_{ij} D_{ij}^p}{\rho C_p} ,$$

where $\sigma : \mathbf{D}^p$ (the numerator) is the plastically dissipated heat. Using the Kelvin scale is recommended, even though other scales may be used without problems.

The hardening behavior is described by the following equations. The Martensite rate equation is

$$\frac{\partial V_m}{\partial \bar{\varepsilon}^p} = \begin{cases} \frac{1}{A} & \varepsilon < E_{0(\text{mart})} \\ \frac{B}{A} V_m^p \left(\frac{1 - V_m}{V_m} \right)^{\frac{B+1}{B}} \frac{[1 - \tanh(C + D \times T)]}{2} \exp\left(\frac{Q}{T - T_{A0}}\right) & \bar{\varepsilon}^p \geq E_{0(\text{mart})} \end{cases}$$

where $\bar{\varepsilon}^p$ is the effective plastic strain and T is the temperature.

The martensite fraction is integrated from the above rate equation:

$$V_m = \int_0^{\varepsilon} \frac{\partial V_m}{\partial \bar{\varepsilon}^p} d\bar{\varepsilon}^p .$$

It always holds that $0.0 < V_m < 1.0$. The initial martensite content is V_{m0} and must be greater than zero and less than 1.0. Note that V_{m0} is not used during a restart or when initializing the V_{m0} history variable using *INITIAL_STRESS_SHELL.

The yield stress is:

$$\sigma_y = \{B_{HS} - (B_{HS} - A_{HS})\exp(-m[\bar{\epsilon}^p + \epsilon_0]^n)\}(K_1 + K_2T) + \Delta H_{\gamma \rightarrow \alpha'} V_m .$$

The parameters p and B should fulfill the following condition

$$\frac{1+B}{B} < p .$$

If the condition is not fulfilled, then the martensite rate will approach infinity as V_m approaches zero. Setting the parameter ϵ_0 larger than zero (typical range 0.001 - 0.02) is recommended. Apart from the effective true strain a few additional history variables are output; see below.

Output History Variables:

Variable	Description
1	Yield stress of material at temperature TREF. Useful to evaluate the strength of the material after e.g., a simulated forming operation.
2	Volume fraction martensite, V_m
3	CP.EQ.0.0: not used CP.GT.0.0: temperature from adiabatic temperature calculation

***MAT_LAYERED_LINEAR_PLASTICITY**

This is Material Type 114. It is a layered elastoplastic material with an arbitrary stress as a function of strain curve. An arbitrary strain rate dependency can also be defined. This material must be used with the user defined integration rules (see *INTEGRATION-SHELL) for modeling laminated composite and sandwich shells where each layer can be represented by elastoplastic behavior with constitutive constants that vary from layer to layer. Lamination theory is applied to correct for the assumption of a uniform constant shear strain through the thickness of the shell. Unless this correction is applied, the stiffness of the shell can be grossly incorrect leading to poor results. Generally, without the correction the results are too stiff. This model is available for shell elements only. See Remarks below.

Card 1	1	2	3	4	5	6	7	8
Variable	MID	RO	E	PR	SIGY	ETAN	FAIL	TDEL
Type	A	F	F	F	F	F	F	F
Default	none	none	none	none	none	0.0	10 ²⁰	0.0

Card 2	1	2	3	4	5	6	7	8
Variable	C	P	LCSS	LCSR				
Type	F	F	I	I				
Default	0.0	0.0	0	0				

Card 3	1	2	3	4	5	6	7	8
Variable	EPS1	EPS2	EPS3	EPS4	EPS5	EPS6	EPS7	EPS8
Type	F	F	F	F	F	F	F	F
Default	0.0	0.0	0.0	0.0	0.0	0.0	0.0	0.0

Card 4	1	2	3	4	5	6	7	8
Variable	ES1	ES2	ES3	ES4	ES5	ES6	ES7	ES8
Type	F	F	F	F	F	F	F	F
Default	0.0	0.0	0.0	0.0	0.0	0.0	0.0	0.0

VARIABLE**DESCRIPTION**

MID	Material identification. A unique number or label must be specified (see *PART).
RO	Mass density
E	Young's modulus
PR	Poisson's ratio
SIGY	Yield stress
ETAN	Tangent modulus; ignored if LCSS > 0 is defined.
FAIL	Failure flag: LT.0.0: User defined failure subroutine, matusr_24 in dyn21.F, is called to determine failure. EQ.0.0: Failure is not considered. This option is recommended if failure is not of interest since many calculations will be saved. GT.0.0: Plastic strain to failure. When the plastic strain reaches this value, the element is deleted from the calculation.
TDEL	Minimum time step size for automatic element deletion
C	Strain rate parameter, C ; see Remarks below.
P	Strain rate parameter, p ; see Remarks below.
LCSS	Load curve ID or Table ID. Load Curve ID. The load curve defines effective stress as a function of effective plastic strain. If defined, EPS1 - EPS8 and ES1 - ES8 are ignored.

VARIABLE	DESCRIPTION
	<p>Table ID. The table defines for each strain rate value a load curve ID giving the stress as a function of effective plastic strain for that rate; see Figure M24-1. The stress as a function of effective plastic strain curve for the lowest value of strain rate is used if the strain rate falls below the minimum value. Likewise, the stress as a function of effective plastic strain curve for the highest value of strain rate is used if the strain rate exceeds the maximum value. C, P, LCSR, EPS1 – EPS8, and ES1 – ES8 are ignored if a table ID is defined.</p>
LCSR	Load curve ID defining strain rate scaling effect on yield stress
EPS1 - EPS8	Effective plastic strain values (optional if SIGY is defined). At least 2 points should be defined. The first point must be zero corresponding to the initial yield stress. WARNING: If the first point is nonzero the yield stress is extrapolated to determine the initial yield. If this option is used, SIGY and ETAN are ignored and may be input as zero.
ES1 - ES8	Corresponding yield stress values to EPS1 - EPS8.

Remarks:

The stress strain behavior may be treated by a bilinear stress strain curve by defining the tangent modulus, ETAN. Alternately, a curve similar to that shown in [Figure M10-1](#) is expected to be defined by (EPS1, ES1) - (EPS8, ES8); however, an effective stress as a function of effective plastic strain curve (LCSS) may be input instead if eight points are insufficient. The cost is roughly the same for either approach. The most general approach is to use the table definition (LCSS) discussed below.

Three options to account for strain rate effects are possible.

1. Strain rate may be accounted for using the Cowper and Symonds model which scales the yield stress with the factor

$$1 + \left(\frac{\dot{\epsilon}}{C} \right)^{1/p},$$

where $\dot{\epsilon}$ is the strain rate; $\dot{\epsilon} = \sqrt{\dot{\epsilon}_{ij}\dot{\epsilon}_{ij}}$.

2. For complete generality a load curve (LCSR) to scale the yield stress may be input instead. This curve defines the scale factor as a function of strain rate.

3. If different stress as a function of strain curves can be provided for various strain rates, the option using the reference to a table (LCSS) can be used. Then the table input in *DEFINE_TABLE must be used; see [Figure M24-1](#).

*MAT_UNIFIED_CREEP

This is Material Type 115. This is an elastic creep model for modeling creep behavior when plastic behavior is not considered.

Card 1	1	2	3	4	5	6	7	8
Variable	MID	RO	E	PR	A	N	M	
Type	A	F	F	F	F	F	F	
Default	none	none	none	none	none	none	none	

VARIABLE

DESCRIPTION

MID	Material identification. A unique number or label must be specified (see *PART).
RO	Mass density
E	Young's modulus
PR	Poisson's ratio
A	Stress coefficient
N	Stress exponent
M	Time exponent

Remarks:

The effective creep strain, $\bar{\epsilon}^c$, given as:

$$\bar{\epsilon}^c = A\bar{\sigma}^n \bar{t}^m ,$$

where A , n , and m are constants and \bar{t} is the effective time. The effective stress, $\bar{\sigma}$, is defined as:

$$\bar{\sigma} = \sqrt{\frac{3}{2} \sigma_{ij} \sigma_{ij}} .$$

The creep strain, therefore, is only a function of the deviatoric stresses. The volumetric behavior for this material is assumed to be elastic. By varying the time constant m

primary creep ($m < 1$), secondary creep ($m = 1$), and tertiary creep ($m > 1$) can be modeled. This model is described by Whirley and Henshall [1992].

***MAT_UNIFIED_CREEP_ORTHO**

This is Material Type 115_O. This is an orthotropic elastic creep model for modeling creep behavior when plastic behavior is not considered. This material is available for solid elements, thick shell element formulations 3, 5, and 7, and SPH elements. It is available for both explicit and implicit dynamics.

Card 1	1	2	3	4	5	6	7	8
Variable	MID	R0	E1	E2	E3	PR21	PR31	PR32
Type	A	F	F	F	F	F	F	F
Default	none	none	none	none	none	none	none	none

Card 2	1	2	3	4	5	6	7	8
Variable	G12	G23	G13	A	N	M		
Type	F	F	F	F	F	F		
Default	none	none	none	none	none	none		

Card 3	1	2	3	4	5	6	7	8
Variable	AOPT	MACF	XP	YP	ZP	A1	A2	A3
Type	F	F	F	F	F	F	F	F
Default	none	none	none	none	none	none	none	none

Card 4	1	2	3	4	5	6	7	8
Variable	V1	V2	V3	D1	D2	D3	BETA	
Type	F	F	F	F	F	F	F	
Default	none	none	none	none	none	none	none	

VARIABLE**DESCRIPTION**

MID	Material identification. A unique number or label must be specified (see *PART).
RO	Mass density
E_i	Young's moduli
PR_{ij}	Elastic Poisson's ratios
G_{ij}	Elastic shear moduli
A	Stress coefficient
N	Stress exponent
M	Time exponent
AOPT	<p>Material axes option (see MAT_OPTIONTROPIC_ELASTIC, particularly the Material Directions section, for details):</p> <p>EQ.0.0: Locally orthotropic with material axes determined by element nodes 1, 2, and 4, as with *DEFINE_COORDINATE_NODES.</p> <p>EQ.1.0: Locally orthotropic with material axes determined by a point, P, in space and the global location of the element center; this is the \mathbf{a}-direction. This option is for solid elements only.</p> <p>EQ.2.0: Globally orthotropic with material axes determined by vectors defined below, as with *DEFINE_COORDINATE_VECTOR</p>

VARIABLE**DESCRIPTION**

EQ.3.0: Locally orthotropic material axes determined by a vector \mathbf{v} and the normal vector to the plane of the element. The plane of a solid element is the midsurface between the inner surface and outer surface defined by the first four nodes and the last four nodes of the connectivity of the element, respectively. Thus, for solid elements, AOPT = 3 is only available for hexahedrons. \mathbf{a} is determined by taking the cross product of \mathbf{v} with the normal vector, \mathbf{b} is determined by taking the cross product of the normal vector with \mathbf{a} , and \mathbf{c} is the normal vector. Then \mathbf{a} and \mathbf{b} are rotated about \mathbf{c} by an angle BETA. BETA may be set in the keyword input for the element or in the input for this keyword. Note that for solids, the material axes may be switched depending on the choice of MACF. The switch may occur before or after applying BETA depending on the value of MACF.

EQ.4.0: Locally orthotropic in a cylindrical coordinate system with the material axes determined by a vector \mathbf{v} , and an originating point, P , which define the centerline axis. This option is for solid elements only.

LT.0.0: The absolute value of AOPT is a coordinate system ID number (CID on *DEFINE_COORDINATE_OPTION).

MACF

Material axes change flag for solid elements:

EQ.-4: Switch material axes b and c before BETA rotation

EQ.-3: Switch material axes a and c before BETA rotation

EQ.-2: Switch material axes a and b before BETA rotation

EQ.1: No change, default

EQ.2: Switch material axes a and b after BETA rotation

EQ.3: Switch material axes a and c after BETA rotation

EQ.4: Switch material axes b and c after BETA rotation

Figure M2-2 indicates when LS-DYNA applies MACF during the process to obtain the final material axes. If BETA on *ELEMENT_SOLID_{OPTION} is defined, then that BETA is used for the rotation for all AOPT options. Otherwise, if AOPT = 3, the BETA input on Card 4 rotates the axes. For all other values of AOPT, the material axes will be switched as specified by MACF, but no BETA rotation will be performed.

VARIABLE	DESCRIPTION
XP, YP, ZP	Define coordinates of point p for AOPT = 1 and 4
A1, A2, A3	Define components of vector \mathbf{a} for AOPT = 2
V1, V2, V3	Define components of vector \mathbf{v} for AOPT = 3 and 4
D1, D2, D3	Define components of vector \mathbf{d} for AOPT = 2
BETA	Material angle in degrees for AOPT = 3. It may be overridden on the element card; see *ELEMENT_TSHELL_BETA or *ELEMENT_SOLID_ORTHO.

Remarks:

The stress-strain relationship is based on an additive split of the strain,

$$\dot{\boldsymbol{\varepsilon}} = \dot{\boldsymbol{\varepsilon}}_e + \dot{\boldsymbol{\varepsilon}}_c .$$

Here, the multiaxial creep strain is given by

$$\dot{\boldsymbol{\varepsilon}}_c = \dot{\bar{\boldsymbol{\varepsilon}}}_c \frac{2\mathbf{s}}{3\bar{\sigma}} ,$$

and $\bar{\boldsymbol{\varepsilon}}^c$ is the effective creep strain, s the deviatoric stress

$$\mathbf{s} = \boldsymbol{\sigma} - \frac{1}{3} \text{tr}(\boldsymbol{\sigma}) \mathbf{I} .$$

and $\bar{\sigma}$ the effective stress

$$\bar{\sigma} = \sqrt{\frac{3}{2} \mathbf{s} : \mathbf{s}} .$$

The effective creep strain is given by

$$\dot{\bar{\boldsymbol{\varepsilon}}}_c = A \bar{\sigma}^N t^M ,$$

where A , N , and M are constants.

The stress increment is given by

$$\Delta \boldsymbol{\sigma} = \mathbf{C} \Delta \boldsymbol{\varepsilon}_e = \mathbf{C} (\Delta \boldsymbol{\varepsilon} - \Delta \boldsymbol{\varepsilon}_c) ,$$

where the constitutive matrix \mathbf{C} is taken as orthotropic and can be represented in Voigt notation by its inverse as

$$\mathbf{C}^{-1} = \begin{bmatrix} \frac{1}{E_1} & -\frac{\nu_{21}}{E_2} & -\frac{\nu_{31}}{E_3} & & & & \\ -\frac{\nu_{12}}{E_1} & \frac{1}{E_2} & -\frac{\nu_{32}}{E_3} & & & & \\ -\frac{\nu_{13}}{E_1} & -\frac{\nu_{23}}{E_2} & \frac{1}{E_3} & & & & \\ & & & \frac{1}{G_{12}} & & & \\ & & & & \frac{1}{G_{23}} & & \\ & & & & & \frac{1}{G_{13}} & \end{bmatrix} .$$

***MAT_COMPOSITE_LAYUP**

This is Material Type 116. This material is for modeling the elastic responses of composite layups that have an arbitrary number of layers through the shell thickness. A pre-integration is used to compute the extensional, bending, and coupling stiffness for use with the Belytschko-Tsay resultant shell formulation. The angles of the local material axes are specified from layer to layer in the *SECTION_SHELL input. This material model must be used with the user defined integration rule for shells (see *INTEGRATION_SHELL) which allows the elastic constants to change from integration point to integration point. Since the stresses are not computed in the resultant formulation, the stresses output to the binary databases for the resultant elements are zero. Note that this shell *does not use laminated shell theory* and that storage is allocated for just one integration point (as reported in d3hsp) regardless of the layers defined in the integration rule.

Card 1	1	2	3	4	5	6	7	8
Variable	MID	RO	EA	EB	EC	PRBA	PRCA	PRCB
Type	A	F	F	F	F	F	F	F

Card 2	1	2	3	4	5	6	7	8
Variable	GAB	GBC	GCA	AOPT				
Type	F	F	F	F				

Card 3	1	2	3	4	5	6	7	8
Variable	XP	YP	ZP	A1	A2	A3		
Type	F	F	F	F	F	F		

Card 4	1	2	3	4	5	6	7	8
Variable	V1	V2	V3	D1	D2	D3	BETA	
Type	F	F	F	F	F	F	F	

VARIABLE	DESCRIPTION
MID	Material identification. A unique number or label must be specified (see *PART).
RO	Mass density
EA	E_a , Young's modulus in the a -direction
EB	E_b , Young's modulus in the b -direction
EC	E_c , Young's modulus in the c -direction
PRBA	ν_{ba} , Poisson's ratio ba
PRCA	ν_{ca} , Poisson's ratio ca
PRCB	ν_{cb} , Poisson's ratio cb
GAB	G_{ab} , shear modulus ab
GBC	G_{bc} , shear modulus bc
GCA	G_{ca} , shear modulus ca
AOPT	Material axes option, see Figure M2-1 : <p>EQ.0.0: Locally orthotropic with material axes determined by element nodes as shown in Figure M2-1. Nodes 1, 2, and 4 of an element are identical to the nodes used for the definition of a coordinate system as by *DEFINE_COORDINATE_NODES, and then rotated about the shell element normal by an angle BETA.</p> <p>EQ.2.0: Globally orthotropic with material axes determined by vectors defined below, as with *DEFINE_COORDINATE_VECTOR.</p> <p>EQ.3.0: Locally orthotropic material axes determined by rotating the material axes about the element normal by an angle, BETA, from a line in the plane of the element defined by the cross product of the vector, \mathbf{v}, with the element normal.</p> <p>LT.0.0: The absolute value of AOPT is a coordinate system ID number (CID on *DEFINE_COORDINATE_NODES, *DEFINE_COORDINATE_SYSTEM or *DEFINE_COORDINATE_VECTOR).</p>

VARIABLE	DESCRIPTION
XP, YP, ZP	Define coordinates of point p for AOPT = 1 and 4.
A1, A2, A3	Define components of vector \mathbf{a} for AOPT = 2.
V1, V2, V3	Define components of vector \mathbf{v} for AOPT = 3 and 4.
D1, D2, D3	Define components of vector \mathbf{d} for AOPT = 2.
BETA	Material angle in degrees for AOPT = 0 and 3. It may be overridden on the element card; see *ELEMENT_SHELL_BETA.

Remarks:

This material law is based on standard composite lay-up theory. The implementation, [Jones 1975], allows the calculation of the force, N , and moment, M , stress resultants from:

$$\begin{Bmatrix} N_x \\ N_y \\ N_{xy} \end{Bmatrix} = \begin{bmatrix} A_{11} & A_{12} & A_{16} \\ A_{21} & A_{22} & A_{26} \\ A_{16} & A_{26} & A_{66} \end{bmatrix} \begin{Bmatrix} \varepsilon_x^0 \\ \varepsilon_y^0 \\ \varepsilon_z^0 \end{Bmatrix} + \begin{bmatrix} B_{11} & B_{12} & B_{16} \\ B_{21} & B_{22} & B_{26} \\ B_{16} & B_{26} & B_{66} \end{bmatrix} \begin{Bmatrix} \kappa_x \\ \kappa_y \\ \kappa_z \end{Bmatrix}$$

$$\begin{Bmatrix} M_x \\ M_y \\ M_{xy} \end{Bmatrix} = \begin{bmatrix} B_{11} & B_{12} & B_{16} \\ B_{21} & B_{22} & B_{26} \\ B_{16} & B_{26} & B_{66} \end{bmatrix} \begin{Bmatrix} \varepsilon_x^0 \\ \varepsilon_y^0 \\ \varepsilon_z^0 \end{Bmatrix} + \begin{bmatrix} D_{11} & D_{12} & D_{16} \\ D_{21} & D_{22} & D_{26} \\ D_{16} & D_{26} & D_{66} \end{bmatrix} \begin{Bmatrix} \kappa_x \\ \kappa_y \\ \kappa_z \end{Bmatrix}$$

where A_{ij} is the extensional stiffness, D_{ij} is the bending stiffness, and B_{ij} is the coupling stiffness which is a null matrix for symmetric lay-ups. The mid-surface strains and curvatures are denoted by ε_{ij}^0 and κ_{ij} , respectively. Since these stiffness matrices are symmetric, 18 terms are needed per shell element in addition to the shell resultants which are integrated in time. This is considerably less storage than would typically be required with through thickness integration which requires a minimum of eight history variables per integration point. For instance, if 100 layers are used, 800 history variables would be stored. Not only is memory much less for this model, but the CPU time required is also considerably reduced.

*MAT_COMPOSITE_MATRIX

This is Material Type 117. This material is used for modeling the elastic responses of composites where a pre-integration is used to compute the extensional, bending, and coupling stiffness coefficients for use with the Belytschko-Tsay resultant shell formulation. Since the stresses are not computed in the resultant formulation, the stresses output to the binary databases for the resultant elements are zero.

NOTE: This material does not support specification of a material angle, β_i , for each through-thickness integration point of a shell.

Card 1	1	2	3	4	5	6	7	8
Variable	MID	R0						
Type	A	F						

Card 2	1	2	3	4	5	6	7	8
Variable	C11	C12	C22	C13	C23	C33	C14	C24
Type	F	F	F	F	F	F	F	F

Card 3	1	2	3	4	5	6	7	8
Variable	C34	C44	C15	C25	C35	C45	C55	C16
Type	F	F	F	F	F	F	F	F

Card 4	1	2	3	4	5	6	7	8
Variable	C26	C36	C46	C56	C66	AOPT		
Type	F	F	F	F	F	F		

Card 5	1	2	3	4	5	6	7	8
Variable				A1	A2	A3		
Type				F	F	F		

Card 6	1	2	3	4	5	6	7	8
Variable	V1	V2	V3	D1	D2	D3	BETA	
Type	F	F	F	F	F	F	F	

VARIABLE**DESCRIPTION**

MID	Material identification. A unique number or label must be specified (see *PART).
RO	Mass density
CIJ	C_{ij} , coefficients of stiffness matrix in the material coordinate system
AOPT	Material axes option (see MAT_OPTIONTROPIC_ELASTIC for a more complete description): <ul style="list-style-type: none"> EQ.0.0: Locally orthotropic with material axes determined by element nodes as shown in Figure M2-1. Nodes 1, 2, and 4 of an element are identical to the nodes used for the definition of a coordinate system as by *DEFINE_COORDINATE_NODES and then rotated about the shell element normal by an angle BETA. EQ.2.0: Globally orthotropic with material axes determined by vectors defined below, as with *DEFINE_COORDINATE_VECTOR EQ.3.0: Locally orthotropic material axes determined by rotating the material axes about the element normal by an angle, BETA, from a line in the plane of the element defined by the cross product of the vector \mathbf{v} with the element normal

VARIABLE	DESCRIPTION
	LT.0.0: The absolute value of AOPT is a coordinate system ID number (CID on *DEFINE_COORDINATE_NODES, *DEFINE_COORDINATE_SYSTEM or *DEFINE_COORDINATE_VECTOR).
A1, A2, A3	Components of vector a for AOPT = 2
V1, V2, V3	Components of vector v for AOPT = 3
D1, D2, D3	Components of vector d for AOPT = 2
BETA	Material angle in degrees for AOPT = 0 and 3. BETA may be overridden on the element card; see *ELEMENT_SHELL_BETA.

Remarks:

The calculation of the force, N_{ij} , and moment, M_{ij} , stress resultants is given in terms of the membrane strains, ε_i^0 , and shell curvatures, κ_i , as:

$$\begin{bmatrix} N_x \\ N_y \\ N_{xy} \\ M_x \\ M_y \\ M_{xy} \end{bmatrix} = \begin{bmatrix} C_{11} & C_{12} & C_{13} & C_{14} & C_{15} & C_{16} \\ C_{21} & C_{22} & C_{23} & C_{24} & C_{25} & C_{26} \\ C_{31} & C_{32} & C_{33} & C_{34} & C_{35} & C_{36} \\ C_{41} & C_{42} & C_{43} & C_{44} & C_{45} & C_{46} \\ C_{51} & C_{52} & C_{53} & C_{54} & C_{55} & C_{56} \\ C_{61} & C_{62} & C_{63} & C_{64} & C_{65} & C_{66} \end{bmatrix} \begin{bmatrix} \varepsilon_x^0 \\ \varepsilon_y^0 \\ \varepsilon_z^0 \\ \kappa_x \\ \kappa_y \\ \kappa_z \end{bmatrix}$$

where $C_{ij} = C_{ji}$. In this model this symmetric matrix is transformed into the element local system and the coefficients are stored as element history variables. In *MAT_COMPOSITE_DIRECT, the resultants are already assumed to be given in the element local system which reduces the storage since the 21 coefficients are not stored as history variables as part of the element data.

The shell thickness is built into the coefficient matrix and, consequently, within the part ID, which references this material ID. The thickness must be uniform.

***MAT_COMPOSITE_DIRECT**

This is Material Type 118. This material is used for modeling the elastic responses of composites where a pre-integration is used to compute the extensional, bending, and coupling stiffness coefficients for use with the Belytschko-Tsay resultant shell formulation. Since the stresses are not computed in the resultant formulation, the stresses output to the binary databases for the resultant elements are zero.

Card 1	1	2	3	4	5	6	7	8
Variable	MID	RO						
Type	A	F						

Card 2	1	2	3	4	5	6	7	8
Variable	C11	C12	C22	C13	C23	C33	C14	C24
Type	F	F	F	F	F	F	F	F

Card 3	1	2	3	4	5	6	7	8
Variable	C34	C44	C15	C25	C35	C45	C55	C16
Type	F	F	F	F	F	F	F	F

Card 4	1	2	3	4	5	6	7	8
Variable	C26	C36	C46	C56	C66			
Type	F	F	F	F	F			

VARIABLE**DESCRIPTION**

MID	Material identification. A unique number or label must be specified (see *PART).
RO	Mass density

VARIABLE	DESCRIPTION
CIJ	Coefficients of the stiffness matrix, C_{ij}

Remarks:

The calculation of the force, N_{ij} , and moment, M_{ij} , stress resultants is given in terms of the membrane strains, ϵ_i^0 , and shell curvatures, κ_i , as:

$$\begin{pmatrix} N_x \\ N_y \\ N_{xy} \\ M_x \\ M_y \\ M_{xy} \end{pmatrix} = \begin{bmatrix} C_{11} & C_{12} & C_{13} & C_{14} & C_{15} & C_{16} \\ C_{21} & C_{22} & C_{23} & C_{24} & C_{25} & C_{26} \\ C_{31} & C_{32} & C_{33} & C_{34} & C_{35} & C_{36} \\ C_{41} & C_{42} & C_{43} & C_{44} & C_{45} & C_{46} \\ C_{51} & C_{52} & C_{53} & C_{54} & C_{55} & C_{56} \\ C_{61} & C_{62} & C_{63} & C_{64} & C_{65} & C_{66} \end{bmatrix} \begin{pmatrix} \epsilon_x^0 \\ \epsilon_y^0 \\ \epsilon_z^0 \\ \kappa_x \\ \kappa_y \\ \kappa_{xy} \end{pmatrix}$$

where $C_{ij} = C_{ji}$. In this model the stiffness coefficients are already assumed to be given in the element local system which reduces the storage. Great care in the element orientation and choice of the local element system, see *CONTROL_ACCURACY, must be observed if this model is used.

The shell thickness is built into the coefficient matrix and, consequently, within the part ID, which references this material ID, the thickness must be uniform.

***MAT_GENERAL_NONLINEAR_6DOF_DISCRETE_BEAM**

This is Material Type 119. It is a very general spring and damper model. This beam is based on the MAT_SPRING_GENERAL_NONLINEAR option. Additional unloading options have been included. The two nodes defining the beam may be coincident to give a zero length beam or offset to give a finite length beam. For finite length discrete beams the absolute value of the variable SCOOR in the *SECTION_BEAM input should be set to a value of 2.0 or 3.0 to give physically correct behavior. A triad is used to orient the beam for the directional springs.

Card Summary:

Card 1. This card is required.

MID	RO	KT	KR	IUNLD	OFFSET	DAMPF	IFLAG
-----	----	----	----	-------	--------	-------	-------

Card 2. This card is required.

LCIDTR	LCIDTS	LCIDTT	LCIDRR	LCIDRS	LCIDRT		
--------	--------	--------	--------	--------	--------	--	--

Card 3. This card is required.

LCIDTUR	LCIDTUS	LCIDTUT	LCIDRUR	LCIDRUS	LCIDRUT		
---------	---------	---------	---------	---------	---------	--	--

Card 4. This card is required.

LCIDTDR	LCIDTDS	LCIDTDT	LCIDRDR	LCIDRDS	LCIDRDT		
---------	---------	---------	---------	---------	---------	--	--

Card 5. This card is required.

LCIDTER	LCIDTES	LCIDTET	LCIDRER	LCIDRES	LCIDRET		
---------	---------	---------	---------	---------	---------	--	--

Card 6. This card is required.

UTFAILR	UTFAILS	UTFAILT	WTFAILR	WTFAILS	WTFAILT	FCRIT	
---------	---------	---------	---------	---------	---------	-------	--

Card 7. This card is required.

UCFAILR	UCFAILS	UCFAILT	WCFAILR	WCFAILS	WCFAILT		
---------	---------	---------	---------	---------	---------	--	--

Card 8. This card is required.

IUR	IUS	IUT	IWR	IWS	IWT		
-----	-----	-----	-----	-----	-----	--	--

Card 9. This card is read if IFLAG = 2. It is optional.

LM1R1S	LM1R2S	LM1R1T	LM1R2T	LM2R1S	LM2R1T		
--------	--------	--------	--------	--------	--------	--	--

Card 10. This card is read if IFLAG = 2. It is optional.

LUM1R1S	LUM1R2S	LUM1R1T	LUM1R2T	LUM2R1S	LUM2R1T		
---------	---------	---------	---------	---------	---------	--	--

Card 11. This card is read if IFLAG = 2. It is optional.

KUM1R1S	KUM1R2S	KUM1R1T	KUM1R2T	KUM2R1S	KUM2R1T	KUM2R2S	KUM2R2T
---------	---------	---------	---------	---------	---------	---------	---------

Card 12. This card is read if IFLAG = 2. It is optional.

E1TR	E2TR	E1RR	E2RR	E1RS	E2RS	E1RT	E2RT
------	------	------	------	------	------	------	------

Card 13. This card is read if IFLAG = 2. It is optional.

E1M1R1S	E2M1R1S	E1M1R2S	E2M1R2S	E1M1R1T	E2M1R1T	E1M1R2T	E2M1R2T
---------	---------	---------	---------	---------	---------	---------	---------

Card 14. This card is read if IFLAG = 2. It is optional.

E1M2R1S	E2M2R1S	E1M2R1T	E2M2R1T				
---------	---------	---------	---------	--	--	--	--

Card 15. This card is read if IUNLD = 2 and IFLAG = 0 or 1. It is optional.

KTS	KTT	KRS	KRT				
-----	-----	-----	-----	--	--	--	--

Data Card Definitions:

Card 1	1	2	3	4	5	6	7	8
Variable	MID	RO	KT	KR	IUNLD	OFFSET	DAMPF	IFLAG
Type	A	F	F	F	I	F	F	I

VARIABLE

DESCRIPTION

- MID Material identification. A unique number or label must be specified.
- RO Mass density; see also volume in *SECTION_BEAM definition.

VARIABLE	DESCRIPTION
KT	Translational stiffness along local r -axis for IUNLD = 2.0. However, if IFLAG = 2, then it is the translational stiffness for unloading along the local r -axis. If left blank, a value calculated by LS-DYNA will be used.
KR	Rotational stiffness along local r -axis for IUNLD = 2.0. However, if IFLAG = 2, then KR is the rotational stiffness for unloading along the local r -axis. If left blank, a value calculated by LS-DYNA will be used.
IUNLD	Unloading option (see Figure M119-1): EQ.0.0: Loading and unloading follow loading curve EQ.1.0: Loading follows loading curve, unloading follows unloading curve. The unloading curve ID if undefined is taken as the loading curve. EQ.2.0: Loading follows loading curve, unloading follows unloading stiffness, KT or KR, to the unloading curve. The loading and unloading curves may only intersect at the origin of the axes. EQ.3.0: Quadratic unloading from peak displacement value to a permanent offset.
OFFSET	Offset factor between 0.0 and 1.0 to determine permanent set upon unloading if the IUNLD = 3.0. The permanent sets in compression and tension are equal to the product of this offset value and the maximum compressive and tensile displacements, respectively.
DAMPF	Damping factor for stability. Values in the neighborhood of unity are recommended. This damping factor is properly scaled to eliminate time step size dependency. Also, it is active if and only if the local stiffness is defined.
IFLAG	Formulation flag: EQ.0: Displacement formulation which is used in all other models EQ.1: Linear strain formulation. The displacements and velocities are divided by the initial length of the beam. EQ.2: A displacement formulation to simulate the buckling behavior of crushable frames

Card 2	1	2	3	4	5	6	7	8
Variable	LCIDTR	LCIDTS	LCIDTT	LCIDRR	LCIDRS	LCIDRT		
Type	I	I	I	I	I	I		

VARIABLE**DESCRIPTION**

LCIDTR	Load curve ID defining translational force resultant along local r -axis as a function of relative translational displacement. If zero, no stiffness related forces are generated for this degree of freedom. The loading curves must be defined from the most negative displacement to the most positive displacement. The force does not need to increase monotonically. The curves in this input are linearly extrapolated when the displacement range falls outside the curve definition.
LCIDTS	Load curve ID defining translational force resultant along local s -axis as a function of relative translational displacement (IFLAG = 0 or 1 only).
LCIDTT	Load curve ID defining translational force resultant along local t -axis as a function of relative translational displacement (IFLAG = 0 or 1 only).
LCIDRR	Load curve for rotational moment resultant about the local r -axis: IFLAG.NE.2: Load curve ID defining rotational moment resultant about local r -axis as a function of relative rotational displacement IFLAG.EQ.2: Load curve ID defining rotational moment resultant about local r -axis as a function of relative rotational displacement at node 2
LCIDRS	Load curve for rotational moment resultant about local s -axis: IFLAG.NE.2: Load curve ID defining rotational moment resultant about local s -axis as a function of relative rotational displacement IFLAG.EQ.2: Load curve ID defining rotational moment resultant about local s -axis as a function of relative rotational displacement at node 2

VARIABLE	DESCRIPTION
LCIDRT	<p>Load curve for rotational moment resultant about local t-axis:</p> <p>IFLAG.NE.2: Load curve ID defining rotational moment resultant about local t-axis as a function of relative rotational displacement</p> <p>IFLAG.EQ.2: Load curve ID defining rotational moment resultant about local t-axis as a function of relative rotational displacement at node 2</p>

Card 3	1	2	3	4	5	6	7	8
Variable	LCIDTUR	LCIDTUS	LCIDTUT	LCIDRUR	LCIDRUS	LCIDRUT		
Type	I	I	I	I	I	I		

VARIABLE	DESCRIPTION
LCIDTUR	<p>Load curve ID defining translational force resultant along local r-axis as a function of relative translational displacement during unloading. The force values defined by this curve must increase monotonically from the most negative displacement to the most positive displacement. For IUNLD = 1.0, the slope of this curve must equal or exceed the loading curve for stability reasons. This is not the case for IUNLD = 2.0. For loading and unloading to follow the same path simply set LCIDTUR = LCIDTR. For options IUNLD = 0.0 or 3.0 the unloading curve is not required. For IUNLD = 2.0, if LCIDTUR is left blank or zero, the default is to use the same curve for unloading as for loading.</p>
LCIDTUS	<p>Load curve ID defining translational force resultant along local s-axis as a function of relative translational displacement during unloading (IFLAG = 0 or 1 only).</p>
LCIDTUT	<p>Load curve ID defining translational force resultant along local t-axis as a function of relative translational displacement during unloading (IFLAG = 0 or 1 only).</p>
LCIDRUR	<p>Load curve ID defining rotational moment resultant about local r-axis as a function of relative rotational displacement during unloading.</p>

VARIABLE	DESCRIPTION
LCIDRUS	<p>Load curve for rotational moment resultant about local <i>s</i>-axis:</p> <p>IFLAG.NE.2: Load curve ID defining rotational moment resultant about local <i>s</i>-axis as a function of relative rotational displacement during unloading</p> <p>IFLAG.EQ.2: Load curve ID defining rotational moment resultant about local <i>s</i>-axis as a function of relative rotational displacement during unloading at node 2</p>
LCIDRUT	<p>Load curve ID defining rotational moment resultant about local <i>t</i>-axis:</p> <p>IFLAG.NE.2: Load curve ID defining rotational moment resultant about local <i>t</i>-axis as a function of relative rotational displacement during unloading. If zero, no viscous forces are generated for this degree of freedom</p> <p>IFLAG.EQ.2: Load curve ID defining rotational moment resultant about local <i>t</i>-axis as a function of relative rotational displacement during unloading at node 2</p>

Card 4	1	2	3	4	5	6	7	8
Variable	LCIDTDR	LCIDTDS	LCIDTDT	LCIDRDR	LCIDRDS	LCIDRDT		
Type	I	I	I	I	I	I		

VARIABLE	DESCRIPTION
LCIDTDR	Load curve ID defining translational damping force resultant along local <i>r</i> -axis as a function of relative translational velocity.
LCIDTDS	Load curve ID defining translational damping force resultant along local <i>s</i> -axis as a function relative translational velocity.
LCIDTDT	Load curve ID defining translational damping force resultant along local <i>t</i> -axis as a function of relative translational velocity.
LCIDRDR	Load curve ID defining rotational damping moment resultant about local <i>r</i> -axis as a function of relative rotational velocity.

VARIABLE**DESCRIPTION**

LCIDRDS Load curve ID defining rotational damping moment resultant about local s -axis as a function of relative rotational velocity.

LCIDRDT Load curve ID defining rotational damping moment resultant about local t -axis as a function of relative rotational velocity.

Card 5	1	2	3	4	5	6	7	8
Variable	LCIDTER	LCIDTES	LCIDTET	LCIDRER	LCIDRES	LCIDRET		
Type	I	I	I	I	I	I		

VARIABLE**DESCRIPTION**

LCIDTER Load curve ID defining translational damping force scale factor as a function of relative displacement in local r -direction.

LCIDTES Load curve ID defining translational damping force scale factor as a function of relative displacement in local s -direction.

LCIDTET Load curve ID defining translational damping force scale factor as a function of relative displacement in local t -direction.

LCIDRER Load curve ID defining rotational damping moment resultant scale factor as a function of relative displacement in local r -rotation.

LCIDRES Load curve ID defining rotational damping moment resultant scale factor as a function of relative displacement in local s -rotation.

LCIDRET Load curve ID defining rotational damping moment resultant scale factor as a function of relative displacement in local t -rotation.

Card 6	1	2	3	4	5	6	7	8
Variable	UTFAILR	UTFAILS	UTFAILT	WTFAILR	WTFAILS	WTFAILT	FCRIT	
Type	F	F	F	F	F	F	F	

VARIABLE	DESCRIPTION
UTFAILR	Optional, translational displacement at failure in tension. If zero, the corresponding displacement, u_r , is not considered in the failure calculation.
UTFAILS	Optional, translational displacement at failure in tension. If zero, the corresponding displacement, u_s , is not considered in the failure calculation.
UTFAILT	Optional, translational displacement at failure in tension. If zero, the corresponding displacement, u_t , is not considered in the failure calculation.
WTFAILR	Optional, rotational displacement at failure in tension. If zero, the corresponding rotation, θ_r , is not considered in the failure calculation.
WTFAILS	Optional, rotational displacement at failure in tension. If zero, the corresponding rotation, θ_s , is not considered in the failure calculation.
WTFAILT	Optional rotational displacement at failure in tension. If zero, the corresponding rotation, θ_t , is not considered in the failure calculation.
FCRIT	Failure criterion (see Remark 1): <p>EQ.0.0: Two separate criteria, one for negative displacements and rotations, another for positive displacements and rotations</p> <p>EQ.1.0: One criterion that considers both positive and negative displacements and rotations</p>

Card 7	1	2	3	4	5	6	7	8
Variable	UCFAILR	UCFAILS	UCFAILT	WCFAILR	WCFAILS	WCFAILT		
Type	F	F	F	F	F	F		

VARIABLE	DESCRIPTION
UCFAILR	Optional, translational displacement at failure in compression. If zero, the corresponding displacement, u_r , is not considered in the failure calculation. Define as a positive number.
UCFAILS	Optional, translational displacement at failure in compression. If zero, the corresponding displacement, u_s , is not considered in the failure calculation. Define as a positive number.
UCFAILT	Optional, translational displacement at failure in compression. If zero, the corresponding displacement, u_t , is not considered in the failure calculation. Define as a positive number.
WCFAILR	Optional, rotational displacement at failure in compression. If zero, the corresponding rotation, θ_r , is not considered in the failure calculation. Define as a positive number.
WCFAILS	Optional, rotational displacement at failure in compression. If zero, the corresponding rotation, θ_s , is not considered in the failure calculation. Define as a positive number.
WCFAILT	Optional, rotational displacement at failure in compression. If zero, the corresponding rotation, θ_t , is not considered in the failure calculation. Define as a positive number.

Card 8	1	2	3	4	5	6	7	8
Variable	IUR	IUS	IUT	IWR	IWS	IWT		
Type	F	F	F	F	F	F		

VARIABLE	DESCRIPTION
IUR	Initial translational displacement along local r -axis.
IUS	Initial translational displacement along local s -axis.
IUT	Initial translational displacement along local t -axis.
IWR	Initial rotational displacement about the local r -axis.
IWS	Initial rotational displacement about the local s -axis.
IWT	Initial rotational displacement about the local t -axis.

Loading Rotational Moment Card. This card is read if IFLAG = 2. It is optional.

Card 9	1	2	3	4	5	6	7	8
Variable	LM1R1S	LM1R2S	LM1R1T	LM1R2T	LM2R1S	LM2R1T		
Type	I	I	I	I	I	I		

VARIABLE**DESCRIPTION**

LM1R1S	Load curve ID for loading defining rotational moment resultant at node 1 about local <i>s</i> -axis as a function of relative rotational displacement at node 1.
LM1R2S	Load curve ID defining rotational moment resultant at node 1 about local <i>s</i> -axis as a function of relative rotational displacement at node 2.
LM1R1T	Load curve ID defining rotational moment resultant at node 1 about local <i>t</i> -axis as a function of relative rotational displacement at node 1.
LM1R2T	Load curve ID defining rotational moment resultant at node 1 about local <i>t</i> -axis as a function of relative rotational displacement at node 2.
LM2R1S	Load curve ID defining rotational moment resultant at node 2 about local <i>s</i> -axis as a function of relative rotational displacement at node 1.
LM2R1T	Load curve ID defining rotational moment resultant at node 2 about local <i>t</i> -axis as a function of relative rotational displacement at node 1.

Unloading Rotational Moment Card. This card is read if IFLAG = 2. It is optional.

Card 10	1	2	3	4	5	6	7	8
Variable	LUM1R1S	LUM1R2S	LUM1R1T	LUM1R2T	LUM2R1S	LUM2R1T		
Type	I	I	I	I	I	I		

VARIABLE	DESCRIPTION
LUM1R1S	Load curve ID for unloading defining rotational moment resultant at node 1 about local <i>s</i> -axis as a function of relative rotational displacement at node 1
LUM1R2S	Load curve ID for unloading defining rotational moment resultant at node 1 about local <i>s</i> -axis as a function of relative rotational displacement at node 2
LUM1R1T	Load curve ID for unloading defining rotational moment resultant at node 1 about local <i>t</i> -axis as a function of relative rotational displacement at node 1
LUM1R2T	Load curve ID for unloading defining rotational moment resultant at node 1 about local <i>t</i> -axis as a function of relative rotational displacement at node 2
LUM2R1S	Load curve ID for unloading defining rotational moment resultant at node 2 about local <i>s</i> -axis as a function of relative rotational displacement at node 1
LUM2R1T	Load curve ID for unloading defining rotational moment resultant at node 2 about local <i>t</i> -axis as a function of relative rotational displacement at node 1

Unload Stiffness for Bending Moment Card. This card is read if IFLAG = 2. It is optional.

Card 11	1	2	3	4	5	6	7	8
Variable	KUM1R1S	KUM1R2S	KUM1R1T	KUM1R2T	KUM2R1S	KUM2R1T	KUM2R2S	KUM2R2T
Type	F	F	F	F	F	F	F	F

VARIABLE	DESCRIPTION
KUM1R1S	Optional unload stiffness for bending moment about local <i>s</i> -axis at node 1 due to relative rotation at node 1. If left blank, LS-DYNA will calculate this value.
KUM1R2S	Optional unload stiffness for bending moment about local <i>s</i> -axis at node 1 due to relative rotation at node 2. If left blank, LS-DYNA will calculate this value.

VARIABLE	DESCRIPTION
KUM1R1T	Optional unload stiffness for bending moment about local t -axis at node 1 due to relative rotation at node 1. If left blank, LS-DYNA will calculate this value.
KUM1R2T	Optional unload stiffness for bending moment about local t -axis at node 1 due to relative rotation at node 2. If left blank, LS-DYNA will calculate this value.
KUM2R1S	Optional unload stiffness for bending moment about local s -axis at node 2 due to relative rotation at node 1. If left blank, LS-DYNA will calculate this value.
KUM2R1T	Optional unload stiffness for bending moment about local t -axis at node 2 due to relative rotation at node 1. If left blank, LS-DYNA will calculate this value. .
KUM2R2S	Optional unload stiffness for bending moment about local s -axis at node 2 due to relative rotation at node 2. If left blank, LS-DYNA will calculate this value.
KUM2R2T	Optional unload stiffness for bending moment about local t -axis at node 2 due to relative rotation at node 2. If left blank, LS-DYNA will calculate this value.

Elastic limit of loading curves. This card is read if IFLAG = 2. It is optional. If not input, the values derived by LS-DYNA based on the related curves will be used.

Card 12	1	2	3	4	5	6	7	8
Variable	E1TR	E2TR	E1RR	E2RR	E1RS	E2RS	E1RT	E2RT
Type	F	F	F	F	F	F	F	F

VARIABLE	DESCRIPTION
E1TR	Negative, compressive, elastic limit of curve LCIDTR
E2TR	Positive, tensile, elastic limit of curve LCIDTR
E1RR	Negative elastic limit of curve LCIDRR
E2RR	Positive elastic limit of curve LCIDRR

VARIABLE	DESCRIPTION
E1RR	Negative elastic limit of curve LCIDRS
E2RR	Positive elastic limit of curve LCIDRS
E1RT	Negative elastic limit of curve LCIDRT
E2RT	Positive elastic limit of curve LCIDRT

Elastic limit of loading curves. This card is read if IFLAG = 2. It is optional. If not input, the values derived by LS-DYNA based on the related curves will be used.

Card 13	1	2	3	4	5	6	7	8
Variable	E1M1R1S	E2M1R1S	E1M1R2S	E2M1R2S	E1M1R1T	E2M1R1T	E1M1R2T	E2M1R2T
Type	F	F	F	F	F	F	F	F

VARIABLE	DESCRIPTION
E1M1R1S	Negative, tensile, elastic limit of curve LM1R1S
E2M1R1S	Positive, tensile, elastic limit of curve LM1R1S
E1M1R2S	Negative elastic limit of curve LM1R2S
E2M1R2S	Positive elastic limit of curve LM1R2S
E1M1R1T	Negative, tensile, elastic limit of curve LM1R1T
E2M1R1T	Positive, tensile, elastic limit of curve LM1R1T
E1M1R2T	Negative elastic limit of curve LM1R2T
E2M1R2T	Positive elastic limit of curve LM1R2T

Elastic limit of loading curves. This card is read if IFLAG = 2. It is optional. If not input, the values derived by LS-DYNA based on the related curves will be used.

Card 14	1	2	3	4	5	6	7	8
Variable	E1M2R1S	E2M2R1S	E1M2R1T	E2M2R1T				
Type	F	F	F	F				

VARIABLE	DESCRIPTION
E1M2R1S	Negative, tensile, elastic limit of curve LM2R1S
E2M2R1S	Positive, tensile, elastic limit of curve LM2R1S
E1M2R1T	Negative elastic limit of curve LM2R1T
E2M2R1T	Positive elastic limit of curve LM2R1T

Unloading stiffness along local-s and local-t. This card is read if IUNLD = 2 and IFLAG=0 or 1. It is optional. If not input, the values along local r-axis, KT and KR, will be used for all axes.

Card 15	1	2	3	4	5	6	7	8
Variable	KTS	KTT	KRS	KRT				
Type	F	F	F	F				

VARIABLE	DESCRIPTION
KTS	Translational stiffness along local <i>s</i> -axis for IUNLD = 2.0.
KTT	Translational stiffness along local <i>t</i> -axis for IUNLD = 2.0
KRS	Rotational stiffness along local <i>s</i> -axis for IUNLD = 2.0
KRT	Rotational stiffness along local <i>t</i> -axis for IUNLD = 2.0

Remarks:

- Failure Criterion.** When the catastrophic failure criterion is satisfied, the discrete element is deleted. Failure for this material depends directly on the displacement resultants. The failure criterion depends on the value of FCRIT.

If FCRIT = 0.0, failure occurs if either of the following inequalities are satisfied:

$$A^t - 1 \geq 0$$

$$A^c - 1 \geq 0$$

where

$$A^t = \left[\frac{\max(0, u_r)}{u_r^{\text{tfail}}} \right]^2 + \left[\frac{\max(0, u_s)}{u_s^{\text{tfail}}} \right]^2 + \left[\frac{\max(0, u_t)}{u_t^{\text{tfail}}} \right]^2 + \left[\frac{\max(0, \theta_r)}{\theta_r^{\text{tfail}}} \right]^2$$

$$+ \left[\frac{\max(0, \theta_s)}{\theta_s^{\text{tfail}}} \right]^2 + \left[\frac{\max(0, \theta_t)}{\theta_t^{\text{tfail}}} \right]^2$$

$$A^c = \left[\frac{\max(0, u_r)}{u_r^{\text{cfail}}} \right]^2 + \left[\frac{\max(0, u_s)}{u_s^{\text{cfail}}} \right]^2 + \left[\frac{\max(0, u_t)}{u_t^{\text{cfail}}} \right]^2 + \left[\frac{\max(0, \theta_r)}{\theta_r^{\text{cfail}}} \right]^2$$

$$+ \left[\frac{\max(0, \theta_s)}{\theta_s^{\text{cfail}}} \right]^2 + \left[\frac{\max(0, \theta_t)}{\theta_t^{\text{cfail}}} \right]^2$$

Positive (tension) values of displacement and rotation are considered in the first criterion and negative (compression) values in the second. Either the tension failure or the compression failure or both may be used. If any of the input failure displacements and rotations (UTFAILR etc) are left as zero, the corresponding terms will be omitted from the equations for A^t and A^c above.

If FCRIT = 1.0, then a single criterion is used:

$$A^t + A^c - 1 \geq 0$$

Thus, the combined effect of all the displacements and rotations is considered, be they positive or negative.

2. **Force.** There are two formulations for calculating the force. The first is the standard displacement formulation, where, for example, the force in a linear spring is

$$F = -K\Delta\ell$$

for a change in length of the beam of $\Delta\ell$. The second formulation is based on the linear strain, giving a force of

$$F = -K \frac{\Delta\ell}{\ell_0}$$

for a beam with an initial length of ℓ_0 . This option is useful when there are springs of different lengths but otherwise similar construction since it automatically reduces the stiffness of the spring as the length increases, allowing an entire family of springs to be modeled with a single material. Note that all the displacement and velocity components are divided by the initial length, and therefore the scaling applies to the damping and rotational stiffness.

3. **Rotational Displacement.** Rotational displacement is measured in radians.

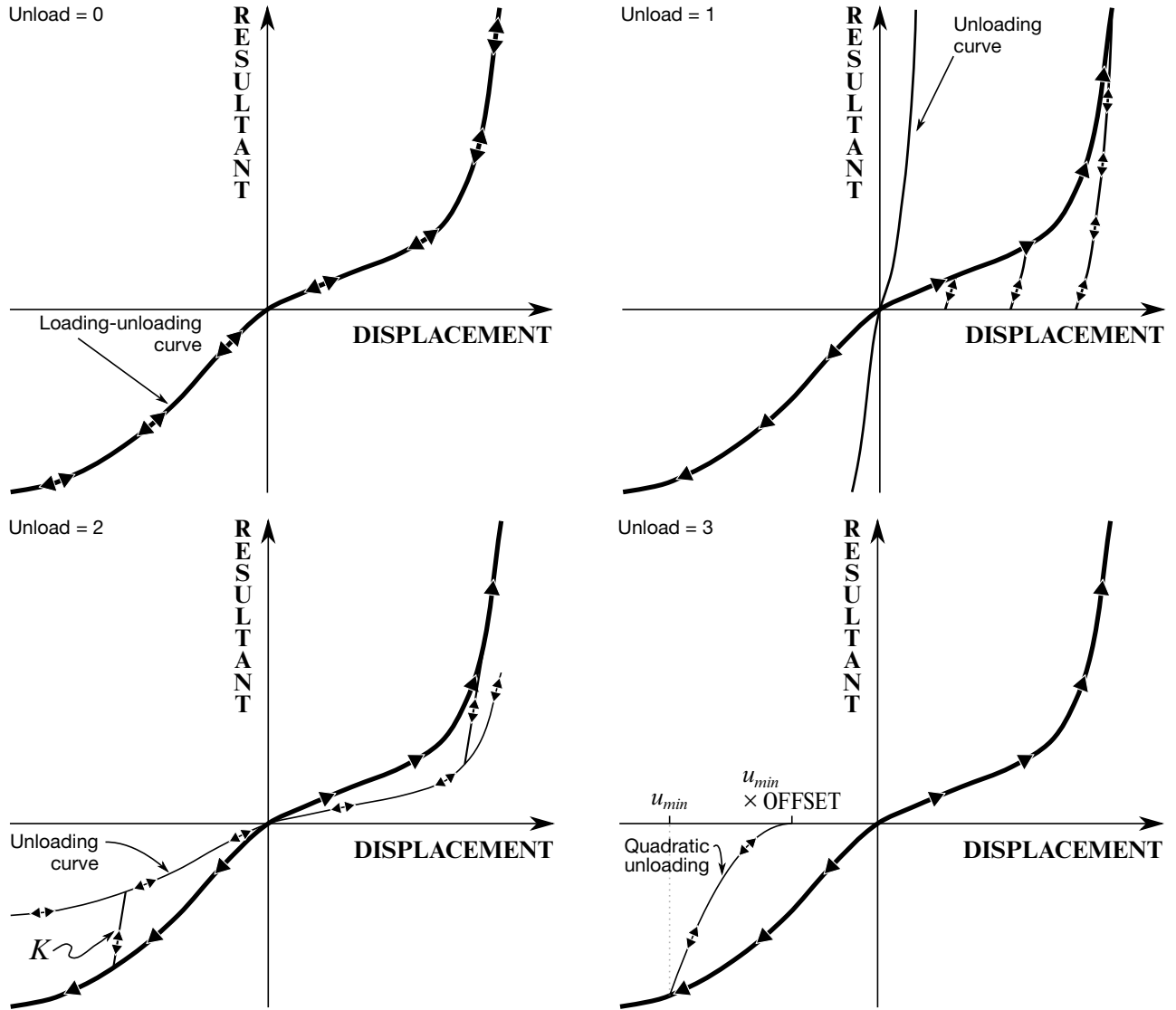

Figure M119-1. Load and unloading behavior.

***MAT_GURSON**

This is Material Type 120. This is the Gurson dilatational-plastic model. This model is available for shell and solid elements. A detailed description of this model can be found in the following references: Gurson [1975, 1977], Chu and Needleman [1980] and Tvergaard and Needleman [1984]. The implementation in LS-DYNA is based on the implementation of Feucht [1998] and Faßnacht [1999], which was recoded at LSTC. Strain rate dependency can be defined using a table (see LCSS on Card 6).

Card Summary:

Card 1. This card is required.

MID	RO	E	PR	SIGY	N	Q1	Q2
-----	----	---	----	------	---	----	----

Card 2. This card is required.

FC	F0	EN	SN	FN	ETAN	ATYP	FF0
----	----	----	----	----	------	------	-----

Card 3. This card is required.

EPS1	EPS2	EPS3	EPS4	EPS5	EPS6	EPS7	EPS8
------	------	------	------	------	------	------	------

Card 4. This card is required.

ES1	ES2	ES3	ES4	ES5	ES6	ES7	ES8
-----	-----	-----	-----	-----	-----	-----	-----

Card 5. This card is required.

L1	L2	L3	L4	FF1	FF2	FF3	FF4
----	----	----	----	-----	-----	-----	-----

Card 6. This card is required.

LCSS	LCFF	NUMINT	LCF0	LCFC	LCFN	VG Typ	DEXP
------	------	--------	------	------	------	--------	------

Data Card Definitions:

Card 1	1	2	3	4	5	6	7	8
Variable	MID	RO	E	PR	SIGY	N	Q1	Q2
Type	A	F	F	F	F	F	F	F

VARIABLE	DESCRIPTION
MID	Material identification. A unique number or label must be specified.
RO	Mass density
E	Young's modulus
PR	Poisson's ratio
SIGY	Yield stress
N	Exponent for Power law (default = 0.0). This value is only used if ATYP = 1 and LCSS = 0 (see Cards 2 and 6).
Q1	Gurson flow function parameter q_1
Q2	Gurson flow function parameter q_2

Card 2	1	2	3	4	5	6	7	8
Variable	FC	F0	EN	SN	FN	ETAN	ATYP	FF0
Type	F	F	F	F	F	F	F	F
Default	0.0	0.0	0.0	0.0	0.0	0.0	0.0	0.0

VARIABLE	DESCRIPTION
FC	Critical void volume fraction f_c where voids begin to aggregate. This value is only used if LCFC = 0 (see Card 6).
F0	Initial void volume fraction, f_0 . This value is only used if LCF0 = 0 (see Card 6).
EN	Mean nucleation strain ϵ_N : GT.0.0: Constant value LT.0.0: Load curve ID = (-EN) which defines mean nucleation strain ϵ_N as a function of element length
SN	Standard deviation s_N of the normal distribution of ϵ_N : GT.0.0: Constant value

VARIABLE	DESCRIPTION
	LT.0.0: Load curve ID = (-SN) which defines standard deviation s_N of the normal distribution of ϵ_N as a function of element length
FN	Void volume fraction of nucleating particles f_N . This value is only used if LCFN = 0 (see Card 6).
ETAN	Hardening modulus. This value is only used if ATYP = 2 and LCSS = 0 (see Card 6).
ATYP	Type of hardening: EQ.0.0: Ideal plastic $\sigma_Y = \text{SIGY}$ EQ.1.0: Power law $\sigma_Y = \text{SIGY} \times \left(\frac{\epsilon^p + \text{SIGY}/E}{\text{SIGY}/E} \right)^{1/N}$ EQ.2.0: Linear hardening $\sigma_Y = \text{SIGY} + \frac{E \times \text{ETAN}}{E - \text{ETAN}} \epsilon^p$ EQ.3.0: 8 points curve
FF0	Failure void volume fraction f_F . This value is only used if no curve is given by (L1, FF1) – (L4, FF4) and LCFF = 0 (see Cards 5 and 6).

Card 3	1	2	3	4	5	6	7	8
Variable	EPS1	EPS2	EPS3	EPS4	EPS5	EPS6	EPS7	EPS8
Type	F	F	F	F	F	F	F	F

Card 4	1	2	3	4	5	6	7	8
Variable	ES1	ES2	ES3	ES4	ES5	ES6	ES7	ES8
Type	F	F	F	F	F	F	F	F

VARIABLE	DESCRIPTION
----------	-------------

EPS1 - EPS8	Effective plastic strain values. The first point must be zero corresponding to the initial yield stress. At least 2 points should be defined. These values are used if ATYP = 3 and LCSS = 0 (see Cards 2 and 6).
-------------	---

ES1 - ES8	Corresponding yield stress values to EPS1 – EPS8. These values are used if ATYP = 3 and LCSS = 0 (see Cards 2 and 6).
-----------	---

Card 5	1	2	3	4	5	6	7	8
Variable	L1	L2	L3	L4	FF1	FF2	FF3	FF4
Type	F	F	F	F	F	F	F	F
Default	0	0	0	0	0	0	0	0

VARIABLE	DESCRIPTION
----------	-------------

L1 - L4	Element length values. These values are only used if LCFF = 0 (see Card 6).
---------	---

FF1 - FF4	Corresponding failure void volume fraction. These values are only used if LCFF = 0 (see Card 6).
-----------	--

Card 6	1	2	3	4	5	6	7	8
Variable	LCSS	LCFF	NUMINT	LCFO	LCFC	LCFN	VG Typ	DEXP
Type	I	I	I	I	I	I	F	F
Default	0	0	1	0	0	0	0	3.0

VARIABLE	DESCRIPTION
----------	-------------

LCSS	Load curve ID or Table ID. If defined, ATYP, EPS1 - EPS8 and ES1 - ES8 are ignored.
------	---

Load Curve. When LCSS is a load curve ID, it is taken as defining effective stress as a function of effective plastic strain.

VARIABLE	DESCRIPTION
	<p>Tabular Data. The table ID defines for each strain rate value a load curve ID giving the effective stress as a function effective plastic strain for that rate; see Figure M24-1 and *MAT_024. When the strain rate falls below the minimum value, the stress as a function of effective plastic strain curve for the lowest value of strain rate is used.</p> <p>Logarithmically Defined Tables. If the <i>first</i> value in the table is negative, LS-DYNA assumes that all the table values represent the natural logarithm of a strain rate. Since the tables are internally discretized to equally space the table values, it makes good sense from an accuracy standpoint that the table values represent the natural log of strain rate when the lowest strain rate and highest strain rate differ by several orders of magnitude.</p>
LCFF	Load curve ID defining failure void volume fraction, f_F , as a function of element length
NUMINT	<p>Number of integration points which must fail before the element is deleted. This option is available for shells and solids.</p> <p>LT.0.0: NUMINT is percentage of integration points/layers which must fail before shell element fails. For fully integrated shells, a methodology is used where a layer fails if one integration point fails and then the given percentage of layers must fail before the element fails. Only available for shells.</p>
LCF0	Load curve ID defining initial void volume fraction, f_0 , as a function of element length
LCFC	Load curve ID defining critical void volume fraction, f_c , as a function of element length
LCFN	Load curve ID defining void volume fraction of nucleating particles, f_N , as a function of element length
VGTYP	<p>Type of void growth behavior:</p> <p>EQ.0.0: Void growth in case of tension and void contraction in case of compression, but never below f_0 (default)</p> <p>EQ.1.0: Void growth only in case of tension</p> <p>EQ.2.0: Void growth in case of tension and void contraction in case of compression, even below f_0</p>

VARIABLE	DESCRIPTION
DEXP	Exponent value for damage history variable 16

Remarks:

The Gurson flow function is defined as:

$$\Phi = \frac{\sigma_M^2}{\sigma_Y^2} + 2q_1 f^* \cosh\left(\frac{3q_2 \sigma_H}{2\sigma_Y}\right) - 1 - (q_1 f^*)^2 = 0 ,$$

where σ_M is the equivalent von Mises stress, σ_Y is the yield stress, and σ_H is the mean hydrostatic stress. The effective void volume fraction is defined as

$$f^*(f) = \begin{cases} f & f \leq f_c \\ f_c + \frac{1/q_1 - f_c}{f_F - f_c} (f - f_c) & f > f_c \end{cases}$$

The growth of void volume fraction is defined as

$$\dot{f} = \dot{f}_G + \dot{f}_N ,$$

where the growth of existing voids is defined as

$$\dot{f}_G = (1 - f) \dot{\epsilon}_{kk}^p$$

and nucleation of new voids is defined as

$$\dot{f}_N = A \dot{\epsilon}_p$$

with function A

$$A = \frac{f_N}{S_N \sqrt{2\pi}} \exp\left[-\frac{1}{2} \left(\frac{\epsilon_p - \epsilon_N}{S_N}\right)^2\right] .$$

Voids are nucleated only in tension.

History Variables:

Shell	Solid	Description
1	1	Void volume fraction
4	2	Triaxiality variable σ_H/σ_M
5	3	Effective strain rate
6	4	Growth of voids
7	5	Nucleation of voids

Shell	Solid	Description
11	11	Dimensionless material damage value = $\begin{cases} \frac{(f-f_0)}{(f_c-f_0)} & f \leq f_c \\ 1 + \frac{(f-f_c)}{(f_F-f_c)} & f > f_c \end{cases}$
13	13	Deviatoric part of microscopic plastic strain
14	14	Volumetric part of macroscopic plastic strain
16	16	Dimensionless material damage value = $\left(\frac{f-f_0}{f_F-f_0}\right)^{1/DEXP}$

*MAT_GURSON_JC

This is an enhancement of Material Type 120. This is the Gurson model with the additional Johnson-Cook failure criterion (see Card 5). This model is available for shell and solid elements. Strain rate dependency can be defined using a table (see LCSS). An extension for void growth under shear-dominated states and for Johnson-Cook damage evolution is optional.

Card Summary:

Card 1. This card is required.

MID	RO	E	PR	SIGY	N	Q1	Q2
-----	----	---	----	------	---	----	----

Card 2. This card is required.

FC	F0	EN	SN	FN	ETAN	ATYP	FF0
----	----	----	----	----	------	------	-----

Card 3. This card is required.

EPS1	EPS2	EPS3	EPS4	EPS5	EPS6	EPS7	EPS8
------	------	------	------	------	------	------	------

Card 4. This card is required.

SIG1	SIG2	SIG3	SIG4	SIG5	SIG6	SIG7	SIG8
------	------	------	------	------	------	------	------

Card 5. This card is required.

LCDAM	L1	L2	D1	D2	D3	D4	LCJC
-------	----	----	----	----	----	----	------

Card 6. This card is required.

LCSS	LCFF	NUMINT	LCF0	LCFC	LCFN	VGTYT	DEXP
------	------	--------	------	------	------	-------	------

Card 7. This card is optional.

KW	BETA	M					
----	------	---	--	--	--	--	--

Data Card Definitions:

Card 1	1	2	3	4	5	6	7	8
Variable	MID	RO	E	PR	SIGY	N	Q1	Q2
Type	A	F	F	F	F	F	F	F
Default	none	none	none	none	none	0.0	none	none

VARIABLE**DESCRIPTION**

MID	Material identification. A unique number or label must be specified (see *PART).
RO	Mass density
E	Young's modulus
PR	Poisson's ratio
SIGY	Yield stress
N	Exponent for power law. This field is only used if ATYP = 1 and LCSS = 0 (see Cards 2 and 6).
Q1	Gurson flow function parameter q_1
Q2	Gurson flow function parameter q_2

Card 2	1	2	3	4	5	6	7	8
Variable	FC	F0	EN	SN	FN	ETAN	ATYP	FF0
Type	F	F	F	F	F	F	F	F
Default	0.0	0.0	0.0	0.0	0.0	0.0	0.0	0.0

VARIABLE**DESCRIPTION**

FC	Critical void volume fraction, f_c , where voids begin to aggregate
----	---

VARIABLE	DESCRIPTION
F0	Initial void volume fraction, f_0 . This field is only used if LCF0 = 0.
EN	Mean nucleation strain, ϵ_N : GT.0.0: Constant value LT.0.0: Load curve ID = (-EN) which defines mean nucleation strain, ϵ_N , as a function of element length
SN	Standard deviation, s_N , of the normal distribution of ϵ_N : GT.0.0: Constant value LT.0.0: Load curve ID = (-SN) which defines standard deviation, s_N , of the normal distribution of ϵ_N as a function of element length
FN	Void volume fraction of nucleating particles, f_N . This field is only used if LCFN = 0.
ETAN	Hardening modulus. This field is only used if ATYP = 2 and LCSS = 0 (see Card 6).
ATYP	Type of hardening: EQ.0.0: Ideal plastic, $\sigma_Y = \text{SIGY}$ EQ.1.0: Power law, $\sigma_Y = \text{SIGY} \times \left(\frac{\epsilon^p + \text{SIGY}/E}{\text{SIGY}/E} \right)^{1/N}$ EQ.2.0: Linear hardening, $\sigma_Y = \text{SIGY} + \frac{E \times \text{ETAN}}{E - \text{ETAN}} \epsilon^p$ EQ.3.0: 8 points curve
FF0	Failure void volume fraction, f_F . This field is only used if LCFF = 0 (see Card 6).

Card 3	1	2	3	4	5	6	7	8
Variable	EPS1	EPS2	EPS3	EPS4	EPS5	EPS6	EPS7	EPS8
Type	F	F	F	F	F	F	F	F

Card 4	1	2	3	4	5	6	7	8
Variable	SIG1	SIG2	SIG3	SIG4	SIG5	SIG6	SIG7	SIG8
Type	F	F	F	F	F	F	F	F

VARIABLE**DESCRIPTION**

EPS1 - EPS8

Effective plastic strain values. The first point must be zero corresponding to the initial yield stress. At least 2 points should be defined. These values are used if ATYP = 3 and LCSS = 0. See Cards 2 and 6.

ES1 - ES8

Corresponding yield stress values to EPS1 – EPS8. These values are used if ATYP = 3 and LCSS = 0. See Cards 2 and 6.

Card 5	1	2	3	4	5	6	7	8
Variable	LCDAM	L1	L2	D1	D2	D3	D4	LCJC
Type	I	F	F	F	F	F	F	I
Default	0	0.0	0.0	0.0	0.0	0.0	0.0	0

VARIABLE**DESCRIPTION**

LCDAM

Load curve defining the scaling factor, Λ , as a function of element length. It scales the Johnson-Cook failure strain (see remarks). If LCDAM = 0, no scaling is performed.

L1

Lower triaxiality factor defining failure evolution (Johnson-Cook)

L2

Upper triaxiality factor defining failure evolution (Johnson-Cook)

D1 - D4

Johnson-Cook damage parameters

LCJC

Load curve defining the scaling factor for Johnson-Cook failure as a function of triaxiality (see remarks). If LCJC > 0, parameters D1, D2 and D3 are ignored.

Card 6	1	2	3	4	5	6	7	8
Variable	LCSS	LCFF	NUMINT	LCFO	LCFC	LCFN	VG Typ	DEXP
Type	I	I	I	I	I	I	F	F
Default	0	0	1	0	0	0	0.0	3.0

VARIABLE**DESCRIPTION**

LCSS

Load curve ID or Table ID. If defined, ATYP, EPS1 - EPS8 and ES1 - ES8 are ignored.

Load Curve. When LCSS is a load curve ID, it is taken as defining effective stress as a function of effective plastic strain.

Tabular Data. The table ID defines for each strain rate value a load curve ID giving the effective stress as a function effective plastic strain for that rate; see [Figure M24-1](#) and *MAT_024. When the strain rate falls below the minimum value, the stress as a function of effective plastic strain curve for the lowest value of strain rate is used.

Logarithmically Defined Tables. If the *first* value in the table is negative, LS-DYNA assumes that all the table values represent the natural logarithm of a strain rate. Since the tables are internally discretized to equally space the table values, it makes good sense from an accuracy standpoint that the table values represent the natural log of strain rate when the lowest strain rate and highest strain rate differ by several orders of magnitude.

LCFF

Load curve ID defining failure void volume fraction, f_F , as a function of element length

NUMINT

Number of through thickness integration points which must fail before the element is deleted. This option is available for shells and solids.

LT.0.0: |NUMINT| is the percentage of integration points/layers which must fail before shell element fails. For fully integrated shells, a methodology is used where a layer fails if one integration point fails and then the given percentage of layers must fail before the element fails. Only available for shells.

VARIABLE	DESCRIPTION
LCF0	Load curve ID defining initial void volume fraction, f_0 , as a function of element length
LCFC	Load curve ID defining critical void volume fraction, f_c , as a function of element length
LCFN	Load curve ID defining void volume fraction of nucleating particles, f_N , as a function of element length
VG Typ	Type of void growth behavior. EQ.0.0: Void growth in case of tension and void contraction in case of compression, but never below f_0 (default) EQ.1.0: Void growth only in case of tension EQ.2.0: Void growth in case of tension and void contraction in case of compression, even below f_0
DEXP	Exponent value for damage history variable 16

Optional Card (starting with version 971 release R4)

Card 7	1	2	3	4	5	6	7	8
Variable	KW	BETA	M					
Type	F	F	F					
Default	0.0	0.0	1.0					

VARIABLE	DESCRIPTION
KW	Parameter k_ω for void growth in shear-dominated states. See remarks.
BETA	Parameter β in Lode cosine function. See remarks.
M	Parameter for generalization of Johnson-Cook damage evolution. See remarks.

Remarks:

The Gurson flow function is defined as:

$$\Phi = \frac{\sigma_M^2}{\sigma_Y^2} + 2q_1 f^* \cosh\left(\frac{3q_2 \sigma_H}{2\sigma_Y}\right) - 1 - (q_1 f^*)^2 = 0$$

where σ_M is the equivalent von Mises stress, σ_Y is the yield stress, and σ_H is the mean hydrostatic stress. The effective void volume fraction is defined as

$$f^*(f) = \begin{cases} f & f \leq f_c \\ f_c + \frac{1/q_1 - f_c}{f_F - f_c} (f - f_c) & f > f_c \end{cases}$$

The growth of void volume fraction is defined as

$$\dot{f} = \dot{f}_G + \dot{f}_N$$

where the growth of existing voids is defined as

$$\dot{f}_G = (1 - f) \dot{\epsilon}_{kk}^p + k_\omega \omega(\sigma) f (1 - f) \dot{\epsilon}_M^{pl} \frac{\sigma_Y}{\sigma_M}$$

The second term is an optional extension for shear failure proposed by Nahshon and Hutchinson [2008] with new parameter k_ω ($= 0$ by default), effective plastic strain rate in the matrix $\dot{\epsilon}_M^{pl}$, and Lode cosin function $\omega(\sigma)$:

$$\omega(\sigma) = 1 - \zeta^2 - \beta \times \zeta (1 - \zeta), \quad \zeta = \cos(3\theta) = \frac{27}{2} \frac{J_3}{\sigma_M^3}$$

with parameter β , Lode angle θ and third deviatoric stress invariant J_3 .

Nucleation of new voids is defined as

$$\dot{f}_N = A \dot{\epsilon}_M^{pl}$$

with function A

$$A = \frac{f_N}{S_N \sqrt{2\pi}} \exp\left[-\frac{1}{2} \left(\frac{\epsilon_M^{pl} - \epsilon_N}{S_N}\right)^2\right].$$

Voids are nucleated only in tension.

The Johnson-Cook failure criterion is added to this material model. Based on the triaxiality ratio σ_H/σ_M failure is calculated as:

$$\sigma_H/\sigma_M > L_1 : \text{Gurson model}$$

$$L_1 \geq \sigma_H/\sigma_M \geq L_2 : \text{Gurson model and Johnson-Cook failure criteria}$$

$$L_2 < \sigma_H/\sigma_M : \text{Gurson model}$$

Johnson-Cook failure strain is defined as

$$\epsilon_f = \left[D_1 + D_2 \exp \left(D_3 \frac{\sigma_H}{\sigma_M} \right) \right] (1 + D_4 \ln \dot{\epsilon}) \Lambda ,$$

where D_1, D_2, D_3 and D_4 are the Johnson-Cook failure parameters and Λ is a function for including mesh-size dependency. An alternative expression can be used, where the first term of the above equation (including D_1, D_2 and D_3) is replaced by a general function LCJC which depends on triaxiality

$$\epsilon_f = \text{LCJC} \times \left(\frac{\sigma_H}{\sigma_M} \right) (1 + D_4 \ln \dot{\epsilon}) \Lambda .$$

The Johnson-Cook damage parameter D_f is calculated with the following evolution equation:

$$\dot{D}_f = \frac{\dot{\epsilon}^{pl}}{\epsilon_f} \Rightarrow D_f = \sum \frac{\Delta \epsilon^{pl}}{\epsilon_f} .$$

where $\Delta \epsilon^{pl}$ is the increment in effective plastic strain. The material fails when D_f reaches 1.0. A more general (non-linear) damage evolution is possible if $M > 1$ is chosen:

$$\dot{D}_f = \frac{M}{\epsilon_f} D_f \left(\frac{1}{\epsilon_f} \right)^{\frac{1}{M}} \quad M \geq 1.0$$

History variables:

Shell	Solid	Description
1	1	Void volume fraction
4	2	Triaxiality variable σ_H/σ_M
5	3	Effective strain rate
6	4	Growth of voids
7	5	Nucleation of voids
8	6	Johnson-Cook failure strain ϵ_f
9	7	Johnson-Cook damage parameter D_f
0	8	Domain variable: EQ.0: elastic stress update EQ.1: region (a) Gurson EQ.2: region (b) Gurson + Johnson-Cook EQ.3: region (c) Gurson

Shell	Solid	Description
11	11	Dimensionless material damage value = $\begin{cases} \frac{(f-f_0)}{(f_c-f_0)} & f \leq f_c \\ 1 + \frac{(f-f_c)}{(f_F-f_c)} & f > f_c \end{cases}$
13	13	Deviatoric part of microscopic plastic strain
14	14	Volumetric part of macroscopic plastic strain
16	16	Dimensionless material damage value = $\left(\frac{f-f_0}{f_F-f_0}\right)^{1/DEXP}$

***MAT_GURSON_RCDC**

This is an enhancement of Material Type 120. This is the Gurson model with the Wilkins Rc-Dc [Wilkins, et al., 1977] fracture model added. This model is available for shell and solid elements. A detailed description of this model can be found in the following references: Gurson [1975, 1977]; Chu and Needleman [1980]; and Tvergaard and Needleman [1984].

Card Summary:

Card 1. This card is required.

MID	RO	E	PR	SIGY	N	Q1	Q2
-----	----	---	----	------	---	----	----

Card 2. Description.

FC	F0	EN	SN	FN	ETAN	ATYP	FF0
----	----	----	----	----	------	------	-----

Card 3. This card is required.

EPS1	EPS2	EPS3	EPS4	EPS5	EPS6	EPS7	EPS8
------	------	------	------	------	------	------	------

Card 4. This card is required.

ES1	ES2	ES3	ES4	ES5	ES6	ES7	ES8
-----	-----	-----	-----	-----	-----	-----	-----

Card 5. This card is required.

L1	L2	L3	L4	FF1	FF2	FF3	FF4
----	----	----	----	-----	-----	-----	-----

Card 6. This card is required.

LCSS	LCFF	NUMINT					
------	------	--------	--	--	--	--	--

Card 7. This card is required.

ALPHA	BETA	GAMMA	D0	B	LAMBDA	DS	L
-------	------	-------	----	---	--------	----	---

Data Card Definitions:

Card 1	1	2	3	4	5	6	7	8
Variable	MID	RO	E	PR	SIGY	N	Q1	Q2
Type	A	F	F	F	F	F	F	F
Default	none	none	none	none	none	0.0	none	none

VARIABLE**DESCRIPTION**

MID	Material identification. A unique number or label must be specified (see *PART).
RO	Mass density
E	Young's modulus
PR	Poisson's ratio
SIGY	Yield stress
N	Exponent for Power law. This field is only used if ATYP = 1 and LCSS = 0. See Cards 2 and 6.
Q1	Gurson flow function parameter q_1
Q1	Gurson flow function parameter q_2

Card 2	1	2	3	4	5	6	7	8
Variable	FC	F0	EN	SN	FN	ETAN	ATYP	FF0
Type	F	F	F	F	F	F	F	F
Default	0.0	0.0	0.0	0.0	0.0	0.0	0.0	0.0

VARIABLE**DESCRIPTION**

FC	Critical void volume fraction, f_c
----	--------------------------------------

VARIABLE	DESCRIPTION
F0	Initial void volume fraction, f_0
EN	Mean nucleation strain, ϵ_N
SN	Standard deviation, S_N , of the normal distribution of ϵ_N
FN	Void volume fraction of nucleating particles
ETAN	Hardening modulus. This field is only used if ATYP = 2 and LCSS = 0. See Card 6.
ATYP	Type of hardening: EQ.0.0: Ideal plastic, $\sigma_Y = \text{SIGY}$ EQ.1.0: Power law, $\sigma_Y = \text{SIGY} \times \left(\frac{\epsilon^p + \text{SIGY}/E}{\text{SIGY}/E} \right)^{1/N}$ EQ.2.0: Linear hardening, $\sigma_Y = \text{SIGY} + \frac{E \times \text{ETAN}}{E - \text{ETAN}} \epsilon^p$ EQ.3.0: 8 points curve
FF0	Failure void volume fraction, f_F . This field is used if no curve is given by the points (L1, FF1) – (L4, FF4) and LCFF = 0. See Cards 5 and 6.

Card 3	1	2	3	4	5	6	7	8
Variable	EPS1	EPS2	EPS3	EPS4	EPS5	EPS6	EPS7	EPS8
Type	F	F	F	F	F	F	F	F

Card 4	1	2	3	4	5	6	7	8
Variable	ES1	ES2	ES3	ES4	ES5	ES6	ES7	ES8
Type	F	F	F	F	F	F	F	F

VARIABLE	DESCRIPTION
EPS1 - EPS8	Effective plastic strain values. The first point must be zero corresponding to the initial yield stress. This option is only used if ATYP equal to 3. At least 2 points should be defined. These values are used if ATYP = 3 and LCSS = 0. See Cards 2 and 6.
ES1 - ES8	Corresponding yield stress values to EPS1 - EPS8. These values are used if ATYP = 3 and LCSS = 0. See Cards 2 and 6.

Card 5	1	2	3	4	5	6	7	8
Variable	L1	L2	L3	L4	FF1	FF2	FF3	FF4
Type	F	F	F	F	F	F	F	F

VARIABLE	DESCRIPTION
L1 - L4	Element length values. These fields are only used if LCLF = 0.
FF1 - FF4	Corresponding failure void volume fraction. These values are only used if LCLF = 0.

Card 6	1	2	3	4	5	6	7	8
Variable	LCSS	LCFF	NUMINT					
Type	I	I	I					
Default	0	0	1					

VARIABLE	DESCRIPTION
LCSS	Load curve ID defining effective stress as a function of effective plastic strain. ATYP is ignored with this option.
LCLF	Load curve ID defining failure void volume fraction as a function of element length. The values L1 - L4 and FF1 - FF4 are ignored with this option.

VARIABLE	DESCRIPTION							
NUMINT	Number of through thickness integration points which must fail before the element is deleted							

Card 7	1	2	3	4	5	6	7	8
Variable	ALPHA	BETA	GAMMA	D0	B	LAMBDA	DS	L
Type	F	F	F	F	F	F	F	F
Default	0	0	0	0	0	0	0	0

VARIABLE	DESCRIPTION
ALPHA	Parameter α for the Rc-Dc model
BETA	Parameter β for the Rc-Dc model
GAMMA	Parameter γ for the Rc-Dc model
D0	Parameter D_0 for the Rc-Dc model
B	Parameter b for the Rc-Dc model
LAMBDA	Parameter λ for the Rc-Dc model
DS	Parameter D_s for the Rc-Dc model
L	Characteristic element length for this material

Remarks:

The Gurson flow function is defined as:

$$\Phi = \frac{\sigma_M^2}{\sigma_Y^2} + 2q_1 f^* \cosh\left(\frac{3q_2 \sigma_H}{2\sigma_Y}\right) - 1 - (q_1 f^*)^2 = 0 ,$$

where σ_M is the equivalent von Mises stress, σ_Y is the Yield stress, and σ_H is the mean hydrostatic stress. The effective void volume fraction is defined as

$$f^*(f) = \begin{cases} f & f \leq f_c \\ f_c + \frac{1/q_1 - f_c}{f_F - f_c} (f - f_c) & f > f_c \end{cases}$$

The growth of the void volume fraction is defined as

$$\dot{f} = \dot{f}_G + \dot{f}_N ,$$

where the growth of existing voids is given as:

$$\dot{f}_G = (1 - f)\dot{\varepsilon}_{kk}^p,$$

and nucleation of new voids as:

$$\dot{f}_N = A\dot{\varepsilon}_p$$

in which A is defined as

$$A = \frac{f_N}{S_N \sqrt{2\pi}} \exp\left(-\frac{1}{2}\left(\frac{\varepsilon_p - \varepsilon_N}{S_N}\right)^2\right) .$$

The Rc-Dc model is described in the following. The damage D is given by

$$D = \int \omega_1 \omega_2 d\varepsilon^p ,$$

where ε^p is the equivalent plastic strain,

$$\omega_1 = \left(\frac{1}{1 - \gamma\sigma_m}\right)^\alpha$$

is a triaxial stress weighting term, and

$$\omega_2 = (2 - A_D)^\beta$$

is a asymmetric strain weighting term. In the above σ_m is the mean stress and

$$A_D = \max\left(\frac{S_2}{S_3}, \frac{S_2}{S_1}\right)$$

Fracture is initiated when the accumulation of damage is

$$\frac{D}{D_c} > 1 ,$$

where D_c is the a critical damage given by

$$D_c = D_0(1 + b|\nabla D|^\lambda) .$$

A fracture fraction

$$F = \frac{D - D_c}{D_s}$$

defines the degradations of the material by the Rc-Dc model.

The characteristic element length is used in the calculation of ∇D . Calculation of this factor is only done for elements with a smaller element length than this value.

***MAT_GENERAL_NONLINEAR_1DOF_DISCRETE_BEAM**

This is Material Type 121. This is a very general spring and damper model. This beam is based on the MAT_SPRING_GENERAL_NONLINEAR option and is a one-dimensional version of the 6DOF_DISCRETE_BEAM above. The forces generated by this model act along a line between the two connected nodal points. Additional unloading options have been included.

Card 1	1	2	3	4	5	6	7	8
Variable	MID	RO	K	IUNLD	OFFSET	DAMPF		
Type	A	F	F	I	F	F		

Card 2	1	2	3	4	5	6	7	8
Variable	LCIDT	LCIDTU	LCIDTD	LCIDTE				
Type	I	I	I	I				

Card 3	1	2	3	4	5	6	7	8
Variable	UTFAIL	UCFAIL	IU					
Type	F	F	F					

VARIABLE**DESCRIPTION**

MID	Material identification. A unique number or label must be specified (see *PART).
RO	Mass density; see also volume in *SECTION_BEAM definition.
K	Translational stiffness for unloading option 2.0
IUNLD	Unloading option (Also see Figure M119-1): EQ.0.0: Loading and unloading follow loading curve.

VARIABLE	DESCRIPTION
	<p>EQ.1.0: Loading follows loading curve; unloading follows unloading curve. The unloading curve ID if undefined is taken as the loading curve.</p> <p>EQ.2.0: Loading follows loading curve; unloading follows unloading stiffness, K, to the unloading curve. The loading and unloading curves may only intersect at the origin of the axes.</p> <p>EQ.3.0: Quadratic unloading from peak displacement value to a permanent offset.</p>
OFFSET	Offset to determine permanent set upon unloading if the $IUNLD = 3.0$. The permanent sets in compression and tension are equal to the product of this offset value and the maximum compressive and tensile displacements, respectively.
DAMPF	Damping factor for stability. Values in the neighborhood of unity are recommended. This damping factor is properly scaled to eliminate time step size dependency. Also, it is active if and only if the local stiffness is defined.
LCIDT	Load curve ID defining translational force resultant along the axis as a function of relative translational displacement. If zero, no stiffness related forces are generated for this degree of freedom. The loading curves must be defined from the most negative displacement to the most positive displacement. The force does not need to increase monotonically for the loading curve. The curves are extrapolated when the displacement range falls outside the curve definition.
LCIDTU	Load curve ID defining translational force resultant along the axis as a function of relative translational displacement during unloading. The force values defined by this curve must increase monotonically from the most negative displacement to the most positive displacement. For $IUNLD = 1.0$, the slope of this curve must equal or exceed the loading curve for stability reasons. This is not the case for $IUNLD = 2.0$. For loading and unloading to follow the same path simply set $LCIDTU = LCIDT$.
LCIDTD	Load curve ID defining translational damping force resultant along the axis as a function of relative translational velocity.
LCIDTE	Load curve ID defining translational damping force scale factor as a function of relative displacement along the axis.

VARIABLE	DESCRIPTION
UTFAIL	Optional, translational displacement at failure in tension. If zero, failure in tension is not considered.
UCFAIL	Optional, translational displacement at failure in compression. If zero, failure in compression is not considered.
IU	Initial translational displacement along axis

Remarks:

Rotational displacement is measured in radians.

***MAT_HILL_3R**

This is Material Type 122. This is Hill's 1948 planar anisotropic material model with 3 R values.

Card Summary:

Card 1. This card is required.

MID	RO	E	PR	HR	P1	P2	
-----	----	---	----	----	----	----	--

Card 2. This card is required.

R00	R45	R90	LCID	E0			
-----	-----	-----	------	----	--	--	--

Card 3. This card is required.

AOPT							
------	--	--	--	--	--	--	--

Card 4. This card is required.

			A1	A2	A3		
--	--	--	----	----	----	--	--

Card 5. This card is required.

V1	V2	V3	D1	D2	D3	BETA	
----	----	----	----	----	----	------	--

Data Card Definitions:

Card 1	1	2	3	4	5	6	7	8
Variable	MID	RO	E	PR	HR	P1	P2	
Type	A	F	F	F	F	F	F	

VARIABLE**DESCRIPTION**

MID	Material identification. A unique number or label must be specified (see *PART).
RO	Mass density
E	Young's modulus, E

VARIABLE	DESCRIPTION
PR	Poisson's ratio, ν
HR	Hardening rule: EQ.1.0: Linear (default) EQ.2.0: Exponential EQ.3.0: Load curve
P1	Material parameter: HR.EQ.1.0: Tangent modulus HR.EQ.2.0: k , strength coefficient for exponential hardening
P2	Material parameter: HR.EQ.1.0: Yield stress HR.EQ.2.0: n , exponent

Card 2	1	2	3	4	5	6	7	8
Variable	R00	R45	R90	LCID	E0			
Type	F	F	F	F	F			

VARIABLE	DESCRIPTION
R00	R_{00} , Lankford parameter determined from experiments
R45	R_{45} , Lankford parameter determined from experiments
R90	R_{90} , Lankford parameter determined from experiments
LCID	Load curve ID for the load curve hardening rule
E0	ϵ_0 for determining initial yield stress for exponential hardening. (default = 0.0)

Card 3	1	2	3	4	5	6	7	8
Variable	AOPT							
Type	F							

VARIABLE

DESCRIPTION

AOPT

Material axes option (see *MAT_OPTIONTROPIC_ELASTIC for a more complete description):

EQ.0.0: Locally orthotropic with material axes determined by element nodes 1, 2, and 4, as with *DEFINE_COORDINATE_NODES. The material axes are then rotated about the shell element normal by an angle BETA.

EQ.2.0: Globally orthotropic with material axes determined by the vector **a** defined below, as with *DEFINE_COORDINATE_VECTOR

EQ.3.0: Locally orthotropic material axes determined by rotating the material axes about the element normal by an angle, BETA, from a line in the plane of the element defined by the cross product of the vector **v** with the element normal

LT.0.0: The absolute value of AOPT is a coordinate system ID number (CID on *DEFINE_COORDINATE_NODES, *DEFINE_COORDINATE_SYSTEM or *DEFINE_COORDINATE_VECTOR). Available in R3 version of 971 and later.

Card 4	1	2	3	4	5	6	7	8
Variable				A1	A2	A3		
Type				F	F	F		

VARIABLE

DESCRIPTION

A1 A2 A3

Components of vector **a** for AOPT = 2

Card 5	1	2	3	4	5	6	7	8
Variable	V1	V2	V3	D1	D2	D3	BETA	
Type	F	F	F	F	F	F	F	

VARIABLE**DESCRIPTION**

V1 V2 V3

Components of vector \mathbf{v} for AOPT = 3

D1 D2 D3

Components of vector \mathbf{d} for AOPT = 2

BETA

Material angle in degrees for AOPT = 0 and 3. It may be overridden on the element card; see *ELEMENT_SHELL_BETA.

Remarks:

The calculated effective stress is stored in history variable #4.

*MAT_HILL_3R_3D

This is Material Type 122_3D. It combines orthotropic elastic behavior with Hill’s 1948 anisotropic plasticity theory. Anisotropic plastic properties are given by 6 material parameters, *F, G, H, L, M, N*, which are determined by experiments. This model is implemented for solid elements.

This keyword can be written either as *MAT_HILL_3R_3D or *MAT_122_3D.

Card Summary:

Card 1. This card is required.

MID	RO	EX	EY	EZ	PRXY	PRYZ	PRXZ
-----	----	----	----	----	------	------	------

Card 2. This card is required.

GXY	GYZ	GXZ	F	G	H	L	M
-----	-----	-----	---	---	---	---	---

Card 3. This card is required.

N	HR	P1	P2				
---	----	----	----	--	--	--	--

Card 4. This card is required.

AOPT							
------	--	--	--	--	--	--	--

Card 5. This card is required.

XP	YP	ZP	A1	A2	A3		
----	----	----	----	----	----	--	--

Card 6. This card is required.

V1	V2	V3	D1	D2	D3		
----	----	----	----	----	----	--	--

Data Card Definitions:

Card 1	1	2	3	4	5	6	7	8
Variable	MID	RO	EX	EY	EZ	PRXY	PRYZ	PRXZ
Type	A	F	F	F	F	F	F	F

VARIABLE	DESCRIPTION
-----------------	--------------------

MID	Material identification. A unique number or label must be specified (see *PART).
RO	Mass density
EX	E_x , Young's modulus in the x -direction LT.0.0: EX is a load curve ID defining E_x as a function of temperature.
EY	E_y , Young's modulus in the y -direction LT.0.0: EY is a load curve ID defining E_y as a function of temperature.
EZ	E_z , Young's modulus in the z -direction LT.0.0: EZ is a load curve ID defining E_z as a function of temperature.
PRXY	ν_{xy} , Poisson's ratio xy LT.0.0: PRXY is a load curve ID defining ν_{xy} as a function of temperature.
PRYZ	ν_{yz} , Poisson's ratio yz LT.0.0: PRYZ is a load curve ID defining ν_{yz} as a function of temperature.
PRXZ	ν_{xz} , Poisson's ratio xz LT.0.0: PRXZ is a load curve ID defining ν_{xz} as a function of temperature.

Card 2	1	2	3	4	5	6	7	8
Variable	GXY	GYZ	GXZ	F	G	H	L	M
Type	F	F	F	F	F	F	F	F

VARIABLE	DESCRIPTION
-----------------	--------------------

GXY	G_{xy} , shear modulus xy
-----	-------------------------------

VARIABLE	DESCRIPTION
	LT.0.0: GXY is load curve ID defining G_{xy} as a function of temperature.
GYZ	G_{yz} , shear modulus yz LT.0.0: GYZ is load curve ID defining G_{yz} as a function of temperature.
GXZ	G_{xz} , shear modulus xz LT.0.0: GXZ is load curve ID defining G_{xz} as a function of temperature.
F	Material constant in Hill's 1948 yield criterion (see Remark 1). LT.0.0: F is a load curve ID defining F as a function of temperature.
G	Material constant in Hill's 1948 yield criterion (see Remark 1). LT.0.0: G is a load curve ID defining G as a function of temperature.
H	Material constant in Hill's 1948 yield criterion (see Remark 1). LT.0.0: H is a load curve ID defining H as a function of temperature.
L	Material constant in Hill's 1948 yield criterion (see Remark 1). LT.0.0: L is a load curve ID defining L as a function of temperature.
M	Material constant in Hill's 1948 yield criterion (see Remark 1). LT.0.0: M is a load curve ID defining M as a function of temperature.

Card 3	1	2	3	4	5	6	7	8
Variable	N	HR	P1	P2				
Type	F	I	I/F	F				

VARIABLE	DESCRIPTION
-----------------	--------------------

N Material constant in Hill's 1948 yield criterion (see [Remark 1](#)).
 LT.0.0: |N| is a load curve ID defining *N* as a function of temperature.

HR Hardening rule:
 EQ.1: stress-strain relationship is defined by load curve or 2D table ID, P1. P2 is ignored.
 EQ.2: stress-strain relationship is defined by strength coefficient *k* (P1) and strain hardening coefficient *n* (P2), as in Swift's exponential hardening equation:

$$\sigma_{yield} = k(\epsilon + 0.01)^n .$$

P1 Material parameter:
 HR.EQ.1: load curve or 2D table ID defining stress-strain curve.
 If P1 is a 2D table ID, the table gives stress-strain curves for different temperatures.
 HR.EQ.2: *k*, strength coefficient in $\sigma_{yield} = k(\epsilon + 0.01)^n$

P2 Material parameter:
 HR.EQ.1: not used
 HR.EQ.2.0: *n*, the exponent in $\sigma_{yield} = k(\epsilon + 0.01)^n$

Card 4	1	2	3	4	5	6	7	8
Variable	AOPT							
Type	I							

VARIABLE	DESCRIPTION
-----------------	--------------------

AOPT Material axes option (see MAT_OPTIONTROPIC_ELASTIC for a more complete description):
 EQ.0.0: locally orthotropic with material axes determined by element nodes 1, 2, and 4, as with *DEFINE_COORDINATE_NODES

VARIABLE	DESCRIPTION							
	EQ.1.0: locally orthotropic with material axes determined by a point p in space and the global location of the element center; this is the a -direction.							
	EQ.2.0: globally orthotropic with material axes determined by the vectors \mathbf{a} and \mathbf{d} , as with *DEFINE_COORDINATE_VECTOR.							
	EQ.3.0: locally orthotropic material axes determined by rotating the material axes about the element normal by an angle, BETA, from a line in the plane of the element defined by the cross product of the vector \mathbf{v} with the element normal.							
	EQ.4.0: locally orthotropic in cylindrical coordinate system with the material axes determined by a vector \mathbf{v} , and an originating point, \mathbf{p} , which define the centerline axis.							
	LT.0.0: the absolute value of AOPT is a coordinate system ID number (CID on *DEFINE_COORDINATE_NODES, *DEFINE_COORDINATE_SYSTEM or *DEFINE_COORDINATE_VECTOR).							

Card 5	1	2	3	4	5	6	7	8
Variable	XP	YP	ZP	A1	A2	A3		
Type	F	F	F	F	F	F		

VARIABLE	DESCRIPTION							
XP, YP, ZP	Coordinates of point p for AOPT = 1 and 4							
A1, A2, A3	Components of vector \mathbf{a} for AOPT = 2							

Card 6	1	2	3	4	5	6	7	8
Variable	V1	V2	V3	D1	D2	D3	BETA	
Type	F	F	F	F	F	F	F	

VARIABLE	DESCRIPTION
V1, V2, V3	Components of vector v for AOPT = 3 and 4
D1, D2, D3	Components of vector d for AOPT = 2
BETA	Material angle in degrees for AOPT = 3. It may be overridden on the element card; see *ELEMENT_SOLID_ORTHO.

Remarks:

- Hill's 1948 Yield Criterion.** Hill's yield criterion is based on the assumptions that the material is orthotropic, that hydrostatic stress does not affect yielding, and that there is no Bauschinger effect. According to Hill, when the principal axes of anisotropy are the axes of reference, the yield surface has the form

$$f = \bar{\sigma}(\sigma) - \sigma_{\text{yield}}(\epsilon_p) = 0,$$

where the effective stress $\bar{\sigma}$ (stored as history variable #2) is given by

$$(F + G)\bar{\sigma}^2 = F(\sigma_y - \sigma_z)^2 + G(\sigma_z - \sigma_x)^2 + H(\sigma_x - \sigma_y)^2 + 2L\tau_{yz}^2 + 2M\tau_{zx}^2 + 2N\tau_{xy}^2,$$

and where $F, G, H, L, M,$ and N are material parameters of the current state of anisotropy, assuming three mutually orthogonal planes of symmetry at every point. The material z -direction is the reference direction.

Let X, Y, Z be the tensile yield stresses in the principal directions of anisotropy, then

$$\frac{\sigma_{y0}^2}{X^2} = \frac{G + H}{F + G}, \quad \frac{\sigma_{y0}^2}{Y^2} = \frac{H + F}{F + G}, \quad \frac{\sigma_{y0}^2}{Z^2} = 1,$$

where $\sigma_{y0} = \sigma_{\text{yield}}(0)$. $F, G,$ and H are not uniquely determined, but the choice of $F + G = 1$ gives

$$F = \frac{Z^2}{2} \left(\frac{1}{Y^2} + \frac{1}{Z^2} - \frac{1}{X^2} \right)$$

$$G = \frac{Z^2}{2} \left(\frac{1}{X^2} + \frac{1}{Z^2} - \frac{1}{Y^2} \right)$$

$$H = \frac{Z^2}{2} \left(\frac{1}{X^2} + \frac{1}{Y^2} - \frac{1}{Z^2} \right)$$

If $R_{xy}, S_{zx},$ and T_{xy} are the yield stresses in shear with respect to the principal axes of anisotropy, then

$$L = \frac{Z^2}{2R_{xy}^2}, \quad M = \frac{Z^2}{2S_{zx}^2}, \quad N = \frac{Z^2}{2T_{xy}^2}.$$

If $F = G = H$, and, $L = M = N = 3F$, the Hill criterion reduces to the Von-Mises criterion.

The strain hardening in this model can either defined by the load curve or by Swift's exponential hardening equation: $\sigma_{\text{yield}} = k(\varepsilon + 0.01)^n$.

2. **Applications.** This material model is suitable for metal forming application using solid elements to account for anisotropic plasticity. NUMISHEET conferences have provided material constants of Hill's 1948 yield for many commonly used materials.

It can also be applied to multi-scale simulations of fiberglass and laminated materials, according to CYBERNET SYSTEMS CO., LTD. The elastic coefficients can be calibrated analytically by a homogenization method with tensile tests in the three orthogonal directions and three pure shear tests in the three orthogonal planes.

3. **Material Parameter Calibration.** The six material parameters required can be calibrated with nonlinear regression analysis (such as those available through LS-OPT) through a series of tensile tests in three orthogonal directions and three shear tests in three orthogonal planes.

Revision information:

This material model is available for explicit dynamics in both SMP and MPP starting in Revision 86100 and is available for implicit dynamics in both SMP and MPP starting in Revision 104178. It also supports temperature dependent Young's/shear modulus, Poisson ratios, and Hill parameters.

*MAT_122_TABULATED

*MAT_HILL_3R_TABULATED

*MAT_HILL_3R_TABULATED

This is Material Type 122. This is Hill's 1948 planar anisotropic material model with 3 R values and yield curves defined in 3 directions as well as biaxial or shear yield. It is implemented for shell elements.

Card 1	1	2	3	4	5	6	7	8
Variable	MID	R0	E	PR	HR			
Type	A8	F	F	F	F			

Card 2	1	2	3	4	5	6	7	8
Variable	R00	R45	R90	LC00	ICONV	LC90	LC45	LCEX
Type	F	F	F	I	I	I	I	I

Card 3	1	2	3	4	5	6	7	8
Variable	AOPT							
Type	F							

Card 4	1	2	3	4	5	6	7	8
Variable				A1	A2	A3		
Type				F	F	F		

Card 5	1	2	3	4	5	6	7	8
Variable	V1	V2	V3	D1	D2	D3	BETA	
Type	F	F	F	F	F	F	F	

VARIABLE	DESCRIPTION
MID	Material identification. A unique number or label not exceeding 8 characters must be specified.
RO	Mass density
E	Young's modulus, E
PR	Poisson's ratio, ν
HR	Hardening rule: EQ.1.0: not applicable EQ.2.0: not applicable EQ.3.0: load curve
R00	R_{00} , Lankford parameter determined from experiments
R45	R_{45} , Lankford parameter determined from experiments
R90	R_{90} , Lankford parameter determined from experiments
LC00	Load curve ID for the yield curve in the 0° direction
ICONV	Convexity option: EQ.0.0: convexity of the yield surface is not enforced. EQ.1.0: convexity of the yield surface is enforced.
LC90	Load curve ID for the yield curve in the 90° direction
LC45	Load curve ID for the yield curve in the 45° direction
LCEX	Absolute value is load curve ID for the yield curve in shear or bi-axial: GT.0.0: shear yield is provided LT.0.0: biaxial yield is provided
AOPT	Material axes option (see MAT_OPTIONTROPIC_ELASTIC for a more complete description):

VARIABLE	DESCRIPTION
	EQ.0.0: locally orthotropic with material axes determined by element nodes 1, 2, and 4, as with *DEFINE_COORDINATE_NODES that are then rotated about the shell element normal by an angle BETA
	EQ.2.0: globally orthotropic with material axes determined by the vector a defined below, as with *DEFINE_COORDINATE_VECTOR
	EQ.3.0: locally orthotropic material axes determined by rotating the material axes about the element normal by an angle, BETA, from a line in the plane of the element defined by the cross product of the vector v with the element normal
	LT.0.0: the absolute value of AOPT is a coordinate system ID number (CID on *DEFINE_COORDINATE_NODES, *DEFINE_COORDINATE_SYSTEM or *DEFINE_COORDINATE_VECTOR). Available in R3 version of 971 and later.
XP YP ZP	Coordinates of point <i>p</i> for AOPT = 1
A1 A2 A3	Components of vector a for AOPT = 2
V1 V2 V3	Components of vector v for AOPT = 3
D1 D2 D3	Components of vector d for AOPT = 2
BETA	Material angle in degrees for AOPT = 0 and 3. It may be overridden on the element card; see *ELEMENT_SHELL_BETA.

*MAT_MODIFIED_PIECEWISE_LINEAR_PLASTICITY_{OPTION}

This is Material Type 123, which is an elasto-plastic material supporting an arbitrary stress as a function of strain curve as well as arbitrary strain rate dependency. This model is available for shell and solid elements. *MAT_PIECEWISE_LINEAR_PLASTICITY is similar but lacks the enhanced failure criteria. Failure is based on effective plastic strain, thinning strain, the major principal in plane strain component, or a minimum time step size.

Available options include:

- <BLANK>
- LOG_INTERPOLATION
- PRESTRAIN (for shells only)
- RATE
- RTCL
- STOCHASTIC (for shells only)

The LOG_INTERPOLATION keyword option interpolates the strain rate effect in table LCSS with logarithmic interpolation.

The PRESTRAIN option is used to include prestrain when checking for major strain failure. The RATE option is used to account for rate dependence of thinning failure or to invoke viscoelasticity (LCEMOD). The RTCL option is used to activate RTCL damage (see Remark 1). One additional card is needed with any of these options.

The STOCHASTIC keyword option allows spatially varying yield and failure behavior. See *DEFINE_STOCHASTIC_VARIATION for additional information.

Card Summary:

Card 1. This card is required.

MID	RO	E	PR	SIGY	ETAN	FAIL	TDEL
-----	----	---	----	------	------	------	------

Card 2. This card is required.

C	P	LCSS	LCSR	VP	EPSTHIN	EPSMAJ	NUMINT
---	---	------	------	----	---------	--------	--------

Card 3. This card is required.

EPS1	EPS2	EPS3	EPS4	EPS5	EPS6	EPS7	EPS8
------	------	------	------	------	------	------	------

Card 4. This card is required.

ES1	ES2	ES3	ES4	ES5	ES6	ES7	ES8
-----	-----	-----	-----	-----	-----	-----	-----

Card 5. This card included for the PRESTRAIN, RATE, and RTCL keyword options.

LCTSRF	EPS0	TRIAx	IPS	LCEMOD	BETA	RFILTF	
--------	------	-------	-----	--------	------	--------	--

Data Card Definitions:

Card 1	1	2	3	4	5	6	7	8
Variable	MID	RO	E	PR	SIGY	ETAN	FAIL	TDEL
Type	A	F	F	F	F	F	F	F
Default	none	none	none	none	none	0.0	10 ²⁰	0.0

VARIABLE

DESCRIPTION

MID	Material identification. A unique number or label must be specified (see *PART).
RO	Mass density
E	Young's modulus
PR	Poisson's ratio
SIGY	Yield stress
ETAN	Tangent modulus, ignored if LCSS > 0
FAIL	Failure flag: <ul style="list-style-type: none"> LT.0.0: User defined failure subroutine, matusr_24 in dyn21.F, is called to determine failure. EQ.0.0: Failure is not considered. This option is recommended if failure is not of interest since many calculations will be saved. GT.0.0: Plastic strain to failure. When the plastic strain reaches this value, the element is deleted from the calculation.

VARIABLE	DESCRIPTION							
TDEL	Minimum time step size for automatic element deletion							

Card 2	1	2	3	4	5	6	7	8
Variable	C	P	LCSS	LCSR	VP	EPSTHIN	EPSMAJ	NUMINT
Type	F	F	F	F	F	F	F	F
Default	0.0	0.0	0.0	0.0	0.0	0.0	0.0	0.0

VARIABLE	DESCRIPTION							
----------	-------------	--	--	--	--	--	--	--

C Strain rate parameter, C; see [Remark 1](#) of *MAT_PIECEWISE_LINEAR_PLASTICITY.

P Strain rate parameter, P; see [Remark 1](#) of *MAT_PIECEWISE_LINEAR_PLASTICITY.

LCSS Load curve ID or Table ID.
Load Curve. When LCSS is a Load curve ID, it is taken as defining effective stress versus effective plastic strain. If defined EPS1 - EPS8 and ES1 - ES8 are ignored.

Tabular Data. The table ID defines for each strain rate value a load curve ID giving the stress versus effective plastic strain for that rate, See [Figure M24-1](#). When the strain rate falls below the minimum value, the stress versus effective plastic strain curve for the lowest value of strain rate is used. Likewise, when the strain rate exceeds the maximum value the stress versus effective plastic strain curve for the highest value of strain rate is used. Fields C, P, LCSR, EPS1 - EPS8, and ES1 - ES8 are ignored if a Table ID is defined. Linear interpolation between the discrete strain rates is used by default; logarithmic interpolation is used when the LOG_INTERPOLATION option is invoked.

VARIABLE	DESCRIPTION
	Logarithmically Defined Tables. An alternative way to invoke logarithmic interpolation between discrete strain rates is described as follows. If the <i>first</i> value in the table is negative, LS-DYNA assumes that all the table values represent the natural logarithm of a strain rate. Since the tables are internally discretized to equally space the table values, it makes good sense from an accuracy standpoint that the table values represent the natural log of strain rate when the lowest strain rate and highest strain rate differ by several orders of magnitude. There is some additional computational cost associated with invoking logarithmic interpolation.
LCSR	Load curve ID defining strain rate scaling effect on yield stress
VP	Formulation for rate effects: EQ.0.0: Scale yield stress (default) EQ.1.0: Viscoplastic formulation (recommended)
EPSTHIN	Thinning strain at failure. To specify thinning strain to failure as a function of plastic strain rate, see LCTSRF. GT.0.0: Total thinning strain (as in ISTUPD = 1; see *CONTROL_SHELL) LT.0.0: Plastic thinning strain EPSTHIN (as in ISTUPD = 4)
EPSMAJ	Major in plane strain at failure for shells (or) major principal strain at failure for solids (see Remark 1). LT.0: EPSMAJ = EPSMAJ and filtering is activated. The last twelve values of the major strain is stored at each integration point and the average value is used to determine failure.
NUMINT	Number of integration points which must fail before the element is deleted. (If zero, all points must fail.) For fully integrated shell formulations, each of the $4 \times \text{NIP}$ integration points are counted individually in determining a total for failed integration points. NIP is the number of through-thickness integration points. As NUMINT approaches the total number of integration points (NIP for under integrated shells, $4 \times \text{NIP}$ for fully integrated shells), the chance of instability increases.

VARIABLE

DESCRIPTION

LT.0.0: |NUMINT| is the percentage of integration points/layers which must fail before the shell element fails. For fully integrated shells, a methodology is used where a layer fails if one integration point fails and then the given percentage of layers must fail before the element fails. Only available for shells.

Card 3	1	2	3	4	5	6	7	8
Variable	EPS1	EPS2	EPS3	EPS4	EPS5	EPS6	EPS7	EPS8
Type	F	F	F	F	F	F	F	F
Default	0.0	0.0	0.0	0.0	0.0	0.0	0.0	0.0

VARIABLE

DESCRIPTION

EPS1 - EPS8

Effective plastic strain values. At least 2 points should be defined. The first point must be zero corresponding to the initial yield stress. If this option is used, SIGY and ETAN are ignored. WARNING: If the first point is nonzero, the yield stress is extrapolated to determine the initial yield.

Card 4	1	2	3	4	5	6	7	8
Variable	ES1	ES2	ES3	ES4	ES5	ES6	ES7	ES8
Type	F	F	F	F	F	F	F	F
Default	0.0	0.0	0.0	0.0	0.0	0.0	0.0	0.0

VARIABLE

DESCRIPTION

ES1 - ES8

Corresponding yield stress values to EPS1 - EPS8

RTCL/Rate Card. Required if the PRESTRAIN, RATE, or RTCL option is active.

Card 5	1	2	3	4	5	6	7	8
Variable	LCTSRF	EPS0	TRIAX	IPS	LCEMOD	BETA	RFILTF	
Type	I	F	F	I	I	F	F	
Default	0	0.0	0.0	0	0	0.0	0.0	

VARIABLE**DESCRIPTION**

LCTSRF Curve that defines the thinning strain at failure as a function of the plastic strain rate (*The curve should not extrapolate to zero or failure may occur at low strain.*) If LCTSRF is given, the absolute value of EPSTHIN is unimportant; however, the algebraic sign of EPSTHIN governs whether ordinate values in curve LCTSRF are interpreted as total or plastic thinning strain. For example, if plastic thinning strain should be used, then EPSTHIN should be input as a negative value.

EPS0 EPS0 parameter for RTCL damage (see [Remark 2](#)):
 EQ.0.0: RTCL damage is inactive (default).
 GT.0.0: RTCL damage is active.

TRIAX RTCL damage triaxiality limit (see [Remark 2](#)):
 EQ.0.0: No limit (default)
 GT.0.0: Damage does not accumulate when triaxiality exceeds TRIAX.

IPS Flag to add prestrain when checking for major strain failure (see EPSMAJ above on Card 2) for the PRESTRAIN keyword option:
 EQ.0: No prestrain added (default)
 EQ.1: Initial strain set with *INITIAL_STRAIN_SHELL will be used as a prestrain when checking for major strain failure (VP = 0 and shells only).

VARIABLE	DESCRIPTION
LCEMOD	Load curve ID defining Young's modulus as function of effective strain rate. LCEMOD \neq 0 activates viscoelasticity. See *MAT_187L for details. The parameters BETA and RFILTF have to be defined too. (If LCEMOD \neq 0 is used, VP = 1 should be defined and failure options EPSTHIN, EPSMAJ, and RTCL are currently not available.)
BETA	Decay constant in viscoelastic law. BETA has the unit [1/time]. If LCEMOD > 0 is used, a non-zero value for BETA is mandatory.
RFILTF	Smoothing factor on the effective strain rate (default is 0.95). The filtered strain rate is used for the viscoelasticity (LCEMOD > 0). $\dot{\epsilon}_n^{\text{avg}} = \text{RFILTF} \times \dot{\epsilon}_{n-1}^{\text{avg}} + (1 - \text{RFILTF}) \times \dot{\epsilon}_n$

Remarks:

1. **Major Principal Strain Failure.** The EPSMAJ parameter is compared to the major principal strain in the following senses:
 - a) For shells it is the maximum eigenvalue of the in-plane strain tensor that is incremented by the strain increments. If IPS = 1, then prestrain set with *INITIAL_STRAIN_SHELL is also included in the strain measure for shells.
 - b) For solid elements it is calculated as the maximum eigenvalue to the logarithmic strain tensor

$$\epsilon = \frac{1}{2} \ln(\mathbf{F}^T \mathbf{F}) ,$$

where \mathbf{F} is the global deformation gradient.

In sum, both element types use a natural strain measure for determining failure. The major strain calculated in this way is output as history variable #7.

2. **RTCL Damage.** With the RTCL option, an RTCL damage is calculated and elements are deleted when the damage function exceeds 1.0. During each solution cycle, if the plastic strain increment is greater than zero, an increment of RTCL damage is calculated by

$$\Delta f_{\text{damage}} = \frac{1}{\epsilon_0} f \left(\frac{\sigma_H}{\bar{\sigma}} \right)_{\text{RTCL}} d\bar{\epsilon}^p$$

where

$$f\left(\frac{\sigma_H}{\bar{\sigma}}\right)_{RTCL} = \begin{cases} 0 & \frac{\sigma_H}{\bar{\sigma}} \leq -\frac{1}{3} \\ 2 \frac{1 + \frac{\sigma_H}{\bar{\sigma}} \sqrt{12 - 27\left(\frac{\sigma_H}{\bar{\sigma}}\right)^2}}{3 \frac{\sigma_H}{\bar{\sigma}} + \sqrt{12 - 27\left(\frac{\sigma_H}{\bar{\sigma}}\right)^2}} & \frac{1}{3} < \frac{\sigma_H}{\bar{\sigma}} < \frac{1}{3} \\ \frac{1}{1.65} \exp\left(\frac{3\sigma_H}{2\bar{\sigma}}\right) & \frac{\sigma_H}{\bar{\sigma}} \geq \frac{1}{3} \end{cases}$$

and,

- ϵ_0 = uniaxial fracture strain / critical damage value
- σ_H = hydrostatic stress
- $\bar{\sigma}$ = effective stress
- $d\bar{\epsilon}^p$ = effective plastic strain increment

The increments are summed through time and the element is deleted when $f_{\text{damage}} \geq 1.0$. For $0.0 < f_{\text{damage}} < 1.0$, the element strength will not be degraded.

The value of f_{damage} is stored as history variable #9 and can be fringe plotted from d3plot files if the number of extra history variables requested is ≥ 9 on *DATABASE_EXTENT_BINARY.

The optional TRIAX parameter can be used to prevent excessive RTCL damage growth and element erosion for badly shaped elements that might show unrealistically high values for the triaxiality. The triaxiality, $\frac{\sigma_H}{\bar{\sigma}}$, is stored as history variable #11.

3. **Instability Indicator.** To get an idea about the probability of failure, an indicator D is computed internally:

$$D = \max\left(\frac{\bar{\epsilon}^p}{\text{FAIL}}, \frac{-\epsilon_3}{\text{EPSTHIN}}, \frac{\epsilon_I}{\text{EPSMAJ}}\right)$$

and stored as history variable #10. D ranges from 0 (intact) to 1 (failed). $\bar{\epsilon}^p$, $-\epsilon_3$, and ϵ_I are current values of effective plastic strain, thinning strain, and major in plane strain. This instability measure, including the RTCL damage, can also be retrieved from requesting material histories

<i>*DEFINE_MATERIAL_HISTORIES Properties</i>		
Label	Attributes	Description
Instability	- - - -	Failure indicator $\max(D, f_{\text{damage}})$

<i>*DEFINE_MATERIAL_HISTORIES Properties</i>		
Label	Attributes	Description
Plastic Strain Rate	- - - -	Effective plastic strain rate $\dot{\epsilon}_{eff}^p$

Implicit Calculations. For implicit calculations with this material involving severe non-linear hardening, the radial return method may result in inaccurate stress-strain response. Setting IACC = 1 on *CONTROL_ACCURACY activates a fully iterative plasticity algorithm, which will remedy this. This is not to be confused with the MITER flag on *CONTROL_SHELL, which governs the treatment of the plane stress assumption for shell elements. If any failure model is applied with this option, incident failure will initiate damage, and the stress will continuously degrade to zero before erosion for a deformation of 1% plastic strain. For instance, if the failure strain is FAIL = 0.05, then the element is eroded when $\bar{\epsilon}^p = 0.06$ and the material goes from intact to completely damaged between $\bar{\epsilon}^p = 0.05$ and $\bar{\epsilon}^p = 0.06$. The reason is to enhance implicit performance by maintaining continuity in the internal forces.

***MAT_PLASTICITY_COMPRESSION_TENSION**

This is Material Type 124. An isotropic elastic-plastic material where unique yield stress as a function of plastic strain curves can be defined for compression and tension. Also, failure can occur based on a plastic strain or a minimum time step size. Rate effects on the yield stress are modeled either by using the Cowper-Symonds strain rate model or by using two load curves that scale the yield stress values in compression and tension, respectively. Material rate effects, which are independent of the plasticity model, are based on a 6-term Prony series Maxwell mode that generates an additional stress tensor. The viscous stress tensor is superimposed on the stress tensor generated by the plasticity.

Card Summary:

Card 1. This card is required.

MID	RO	E	PR	C	P	FAIL	TDEL
-----	----	---	----	---	---	------	------

Card 2. This card is required.

LCIDC	LCIDT	LCSRC	LCSRT	SRFLAG	LCFAIL	EC	RPCT
-------	-------	-------	-------	--------	--------	----	------

Card 3. This card is required.

PC	PT	PCUTC	PCUTT	PCUTF			SRFILT
----	----	-------	-------	-------	--	--	--------

Card 4. This card is required.

K							
---	--	--	--	--	--	--	--

Card 5. Include up to 6 instances of this card. The next keyword ("*") card terminates this input.

G_i	BETA $_i$						
-------	-----------	--	--	--	--	--	--

Data Card Definitions:

Card 1	1	2	3	4	5	6	7	8
Variable	MID	RO	E	PR	C	P	FAIL	TDEL
Type	A	F	F	F	F	F	F	F
Default	none	none	none	none	0.0	0.0	10 ²⁰	0.0

VARIABLE	DESCRIPTION
MID	Material identification. A unique number or label must be specified (see *PART).
RO	Mass density
E	Young's modulus
PR	Poisson's ratio
C	Strain rate parameter, <i>C</i> . See Remark 1 .
P	Strain rate parameter, <i>P</i> . See Remark 1 .
FAIL	<p>Failure flag:</p> <p>LT.0.0: User defined failure subroutine, <code>matusr_24</code> in <code>dyn21.F</code>, is called to determine failure.</p> <p>EQ.0.0: Failure is not considered. This option is recommended if failure is not of interest since many calculations will be saved.</p> <p>GT.0.0: Plastic strain to failure. When the plastic strain reaches this value, the element is deleted from the calculation.</p>
TDEL	Minimum time step size for automatic deletion of shell elements

Card 2	1	2	3	4	5	6	7	8
Variable	LCIDC	LCIDT	LCSRC	LCSRT	SRFLAG	LCFAIL	EC	RPCT
Type	I	I	I	I	F	I	F	F
Default	0	0	0	0	0.0	0	optional	0.0

VARIABLE	DESCRIPTION
LCIDC	Load curve ID defining effective stress as a function of effective plastic strain in compression. Enter positive yield stress and plastic strain values when defining this curve.

VARIABLE	DESCRIPTION
LCIDT	Load curve ID defining effective stress as a function of effective plastic strain in tension. Enter positive yield stress and plastic strain values when defining this curve.
LCSRC	Optional load curve ID defining strain rate scaling factor on yield stress as a function of strain rate when the material is in compression
LCSRT	Optional load curve ID defining strain rate scaling factor on yield stress as a function of strain rate when the material is in tension
SRFLAG	Formulation for rate effects: EQ.0.0: total strain rate (based on the total strain tensor) EQ.1.0: effective strain rate (based on deviatoric portion of the strain tensor) EQ.2.0: effective plastic strain rate (viscoplastic)
LCFAIL	Optional load curve ID defining effective plastic strain at failure as a function of strain rate. If LCFAIL is specified, FAIL is ignored. See Remark 2 .
EC	Optional Young's modulus for compression, > 0.
RPCT	Fraction of PT and PC, used to define mean stress at which Young's modulus is E and EC, respectively. Young's modulus is E when mean stress > RPCT × PT, and EC when mean stress < -RPCT × PC. If the mean stress falls between -RPCT × PC and RPCT × PT, a linearly interpolated value is used.

Card 3	1	2	3	4	5	6	7	8
Variable	PC	PT	PCUTC	PCUTT	PCUTF			SRFILT
Type	F	F	F	F	F			F
Default	0.0	0.0	0.0	0.0	0.0			0.0

VARIABLE	DESCRIPTION
PC	Compressive mean stress (pressure) at which the yield stress follows load curve ID, LCIDC. If the pressure falls between PC and PT, a weighted average of the two load curves is used. Both PC and PT should be entered as positive values.
PT	Tensile mean stress at which the yield stress follows load curve ID, LCIDT
PCUTC	Pressure cut-off in compression (PCUTC must be greater than or equal to zero). PCUTC (and PCUTT) apply only to element types that use a 3D stress update, such as solids, tshell formulations 3 and 5, and SPH. When the pressure cut-off is reached the deviatoric stress tensor is set to zero and the pressure remains at its compressive value. Like the yield stress, PCUTC is scaled to account for rate effects.
PCUTT	Pressure cut-off in tension (PCUTT must be less than or equal to zero). When the pressure cut-off is reached, the deviatoric stress tensor and tensile pressure is set to zero. Like the yield stress, PCUTT is scaled to account for rate effects.
PCUTF	Pressure cut-off flag activation: EQ.0.0: Inactive EQ.1.0: Active
SRFILT	Strain rate filtering parameter in exponential moving average with admissible values ranging from 0 to 1 (available for LCSRC \neq 0 or LCSRT \neq 0 with SRFLAG = 0 or 1):

$$\dot{\epsilon}_n^{\text{avg}} = \text{SRFILT} \times \dot{\epsilon}_{n-1}^{\text{avg}} + (1 - \text{SRFILT}) \times \dot{\epsilon}_n$$

Card 4	1	2	3	4	5	6	7	8
Variable	K							
Type	F							

VARIABLE	DESCRIPTION
K	Optional bulk modulus for the viscoelastic material. If nonzero, a Kelvin type behavior will be obtained. Generally, K is set to zero.

Viscoelastic Constant Cards. Up to 6 cards may be input. The next keyword (“*”) card terminates this input.

Card 5	1	2	3	4	5	6	7	8
Variable	G_i	BETA i						
Type	F	F						

VARIABLE

DESCRIPTION

G_i	Optional shear relaxation modulus for the i^{th} term
BETA i	Optional shear decay constant for the i^{th} term

Remarks:

1. **Stress-Strain Behavior.** The stress-strain behavior follows a different curve in compression than it does in tension. Tension is determined by the sign of the mean stress where a positive mean stress (meaning a negative pressure) is indicative of tension. Two curves must be defined giving the yield stress as a function of effective plastic strain for both the tension and compression regimes.

Mean stress is an invariant which can be expressed as $(\sigma_x + \sigma_y + \sigma_z)/3$. PC and PT define a range of mean stress values within which interpolation is done between the tensile yield surface and compressive yield surface. PC and PT are not true material properties but are just a numerical convenience so that the transition from one yield surface to the other is not abrupt as the sign of the mean stress changes. Both PC and PT are input as positive values as it is implied that PC is a compressive mean stress value and PT is tensile mean stress value.

Strain rate may be accounted for using the Cowper and Symonds model which scales the yield stress with the factor:

$$1 + \left[\frac{\dot{\epsilon}}{C} \right]^{1/p}$$

If SRFLAG = 0, $\dot{\epsilon}$ is the total strain rate,

$$\dot{\epsilon} = \sqrt{\dot{\epsilon}_{ij}\dot{\epsilon}_{ij}}$$

2. **LCFAIL.** The LCFAIL field is only applicable when at least one of the following four conditions are met:

- a) SRFLAG = 2
- b) LCSRC is nonzero
- c) LCSRT is nonzero
- d) G_i and $BETA_i$ values are provided.

***MAT_KINEMATIC_HARDENING_TRANSVERSELY_ANISOTROPIC_{OPTION}**

This is Material Type 125. This material model combines Yoshida and Uemori's non-linear kinematic hardening rule with material type 37. Yoshida and Uemori's theory uses two surfaces to describe the hardening rule: the yield surface and the bounding surface. In the forming process, the yield surface does not change in size, but its center translates with deformation; the bounding surface changes in both size and location. In addition, the change of Young's modulus can be a function of effective plastic strain, as proposed by Yoshida and Uemori [2002]. This material type is available for shells, thick shells, and solid elements.

Available options include:

<BLANK>

NLP

The NLP option estimates necking failure using the Formability Index (F.I.), which accounts for the non-linear strain paths seen in metal forming applications (see [A Failure Criterion for Nonlinear Strain Paths \(NLP\)](#) in the remarks section). When using this option, specify **IFLD** in Card 3. Since the NLP option also works with a linear strain path, it is recommended to be used as the default failure criterion in metal forming. The NLP option is also available for *MAT_036, *MAT_037, and *MAT_226.

Card 1	1	2	3	4	5	6	7	8
Variable	MID	RO	E	PR	RBAR	HLCID	OPT	
Type	A	F	F	F	F	I	I	
Default	none	none	none	none	none	0	0	

Card 2	1	2	3	4	5	6	7	8
Variable	CB	Y	SC1	K	RSAT	SB	H	SC2
Type	F	F	F	F	F	F	F	F
Default	none	none	none	none	none	none	none	0.0

Card 3	1	2	3	4	5	6	7	8
Variable	EA	COE	IOPT	C1	C2	IFLD		
Type	F	F	I	F	F	I		
Default	none	none	0	none	none	none		

VARIABLE**DESCRIPTION**

MID	Material identification. A unique number or label must be specified (see *PART).
RO	Mass density
E	Young's Modulus
PR	Poisson's ratio
RBAR	Plastic anisotropic parameter \bar{r} (Lankford coefficient), also commonly referred to as "r-bar value" in sheet metal forming literature. For shell elements, $\bar{r} = R_{00} = R_{45} = R_{90}$ is assumed in the plane of the shell.
HLCID	Load curve ID (see *DEFINE_CURVE) giving true strain as a function of true stress. This curve is used with OPT below and should not be referenced or used in other keywords. <i>Using this parameter is not recommended.</i>
OPT	Error calculation flag. The default value of "0" is recommended. EQ.2: LS-DYNA will perform the error calculation based on the true stress-strain curve from uniaxial tension, specified by HLCID. The corrections will be made to the cyclic load curve, both in the loading and unloading portions. Since, in some cases where loading is more complex, the accumulated plastic strain could be large (say more than 30%), the input uniaxial stress-strain curve must have enough strain range to cover the maximum expected plastic strain. Note that this variable must be set to a value of "2" if HLCID is specified and a stress-strain curve is used.
CB	The uppercase <i>B</i> defined in Yoshida & Uemori's equations.

VARIABLE	DESCRIPTION
Y	Hardening parameter appearing in Yoshida & Uemori's equations.
SC1	The lowercase c_2 defined in Yoshida & Uemori's equations. Note the equation below from the paper: $c = \begin{cases} c_1 & \max(\bar{a}_*) < B - Y \\ c_2 & \text{otherwise} \end{cases}$ <p>See more details in About SC1 and SC2 in the remarks section.</p>
K	Hardening parameter appearing in Yoshida & Uemori's equations.
RSAT	Hardening parameter, R_{sat} , appearing in Yoshida & Uemori's equations.
SB	The lowercase b appearing in Yoshida & Uemori's equations.
H	Anisotropic parameter associated with work-hardening stagnation.
SC2	The lowercase c_1 defined in the Yoshida and Uemori's equations. Note the equation below from the paper: $c = \begin{cases} c_1 & \max(\bar{a}_*) < B - Y \\ c_2 & \text{otherwise} \end{cases}$ <p>See more details in About SC1 and SC2 in the remarks section. If SC2 equals 0.0, is left blank, or equals SC1, then it turns into the basic model (the one c model). SC2 is available for solids in Revision 142716.</p>
EA	Variable controlling the change of Young's modulus, E^A in the following equations.
COE	Variable controlling the change of Young's modulus, ζ in the following equations.
IOPT	Modified kinematic hardening rule flag: EQ.0: Original Yoshida & Uemori formulation, EQ.1: Modified formulation. Define C1 and C2 below.
C1, C2	Constants used to modify \dot{R} , so strain hardening will not saturate:

VARIABLE	DESCRIPTION
	$\dot{R} = \text{RSAT} \times [(C_1 + \bar{\epsilon}^p)^{c_2} - C_1^{c_2}]$ <p>Note that these variables are not the material parameter c that controls the rate of the kinematic hardening in the original Yoshida & Uemori paper.</p>
IFLD	ID of a load curve defining Forming Limit Diagram (FLD) under linear strain paths. In the load curve, abscissas represent minor strains, while ordinates represent major strains. Define only when the option NLP is used.

The Yoshida & Uemori Kinematic Hardening Model:

The following equations give the two-surface model from Yoshida and Uemori [2]:

$$\begin{aligned}\alpha_* &= \alpha - \beta \\ \alpha_* &= c \left[\left(\frac{a}{Y} \right) (\sigma - \alpha) - \sqrt{\frac{a}{\alpha_*}} \alpha_* \right] \bar{\epsilon}^p \\ a &= B + R - Y\end{aligned}$$

Figure M125-1 illustrates these variables. The anisotropic hardening parameter, \dot{R} , depends on the value of IOPT. The original Yoshida and Uemori model includes saturation in strain hardening (IOPT = 0) [1, 2] and was modified to include continuous hardening (IOPT = 1). The change in the parameter is as follows:

$$\begin{aligned}\dot{R} &= k(R_{\text{sat}} - R)\dot{\bar{\epsilon}}^p && \text{if IOPT} = 0 \\ \dot{R} &= R_{\text{sat}} \times [(C_1 + \bar{\epsilon}^p)^{c_2} - C_1^{c_2}] && \text{if IOPT} = 1\end{aligned}$$

The change of size and location for the bounding surface is defined as follows, with variable descriptions shown in Figure M125-2,

$$\begin{aligned}\dot{\beta}' &= k \left(\frac{2}{3} bD - \beta' \dot{\bar{\epsilon}}^p \right) \\ \sigma_{\text{bound}} &= B + R + \beta\end{aligned}$$

The unloading process includes work-hardening stagnation in the unloading process. The following equations describe this process:

$$\begin{aligned}g_\sigma(\sigma', q', r') &= \frac{3}{2} (\sigma' - q') : (\sigma' - q') - r^2 \\ \dot{q}' &= \mu(\beta' - q') \\ r &= h\Gamma \\ \Gamma &= \frac{3(\beta' - q') : \dot{\beta}'}{2r}\end{aligned}$$

The change in Young's modulus is defined as a function of effective plastic strain,

$$E = E_0 - (E_0 - E_A)[1 - \exp(-\zeta \bar{\epsilon}^p)] .$$

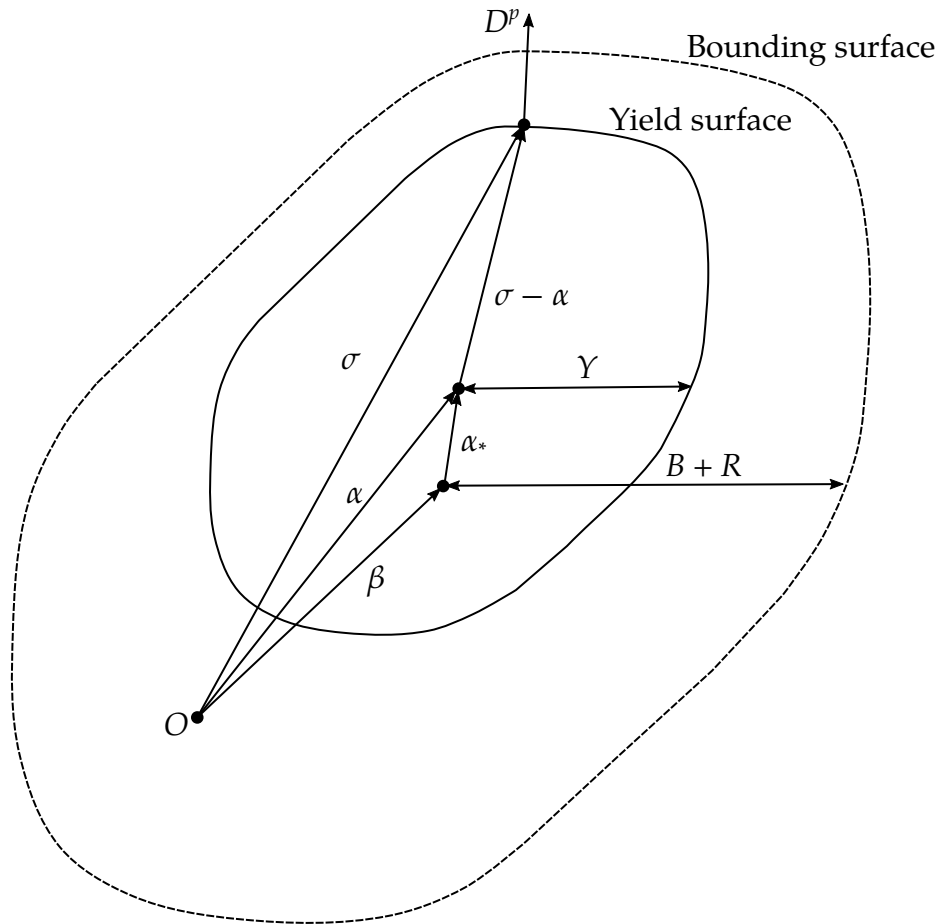

Figure M125-1. Schematic illustration of the two-surface model. O is the original center of the yield surface; α is the current center for the yield surface; β is the center of the bounding surface; and α_* represents the relative position of the centers of the two surfaces. Y is the size of the yield surface and is constant throughout the deformation process. $B + R$ represents the size of the bounding surface, with R being associated with isotropic hardening. *Reproduced from Yoshida and Uemori's original paper.*

About SC1 and SC2:

Yoshida and Uemori's paper includes a modification for the material parameter c , which controls the rate of the kinematic hardening, to describe more accurately the forward and reverse deformations of the cyclic plasticity curve in the vicinity of the initial yield. The paper gives modification of the parameter c as:

$$c = \begin{cases} c_1 & \max(\bar{\alpha}_*) < B - Y \\ c_2 & \text{otherwise} \end{cases}$$

which corresponds to:

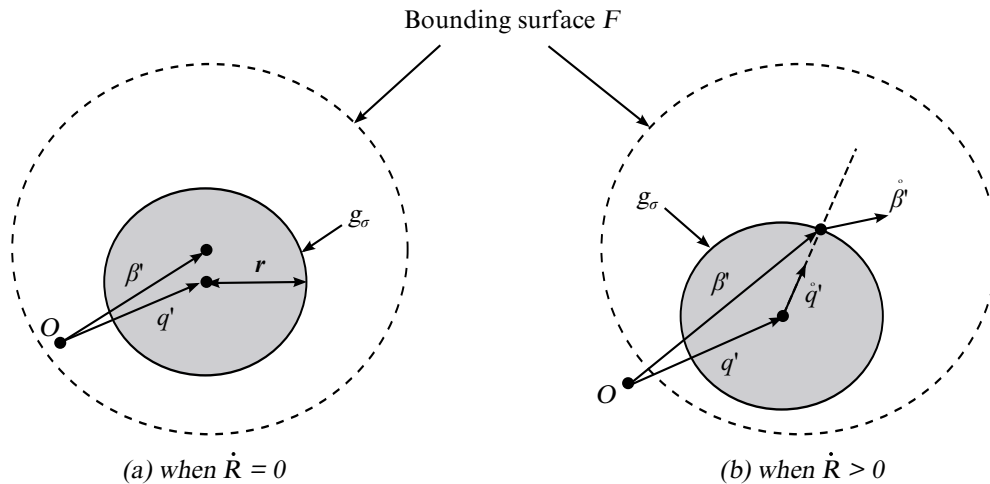

Figure M125-2. Change in bounding surface (reproduced from Yoshida and Uemori's original paper).

$$c = \begin{cases} \text{SC2} & \max(\bar{\alpha}_*) < B - Y \\ \text{SC1} & \text{otherwise} \end{cases}$$

Here α_* is the backstress evolution, $\max(\bar{\alpha}_*)$ is the maximum value of $\bar{\alpha}_*$, and

$$\bar{\alpha}_* = \sqrt{\frac{3}{2} \alpha_* : \alpha_*} .$$

A Failure Criterion for Nonlinear Strain Paths (NLP):

The manual pages for [*MAT_036](#) and [*MAT_037](#) describe the NLP failure criterion and corresponding post-processing procedures. The history variables for every element stored in d3plot files include:

1. Formability Index (F.I.): #1 (#24 after Revision 113708)
2. Strain ratio β (in-plane minor strain increment/major strain increment): #2 (#25 after Revision 113708)
3. Effective strain from the planar isotropic assumption: #3 (#26 after Revision 113708)

To enable the output of these history variables to the d3plot files, NEIPS on the *DATABASE_EXTENT_BINARY card must be set to at least 3.

References:

- [1] Shi, M.F., Zhu, X.H., Xia, Z.C. & Stoughton, T.B. (2008). Determination of nonlinear isotropic/kinematic hardening constitutive parameters for AHSS using tension and compression tests. NUMISH-EET. 2008. 137-142.
- [2] Yoshida, Fusahito & Uemori, Takeshi. (2002). A model of large-strain cyclic plasticity describing the Bauschinger effect and workhardening stagnation. International Journal of Plasticity. 18. 661-686. 10.1016/S0749-6419(01)00050-X.

*MAT_MODIFIED_HONEYCOMB

This is Material Type 126. This material model is usually used for aluminum honeycomb crushable foam materials with anisotropic behavior. Three yield surfaces are available. The first yield surface defines the nonlinear elastoplastic material behavior separately for all normal and shear stresses, which are considered to be fully uncoupled. The second yield surface considers the effects of off-axis loading. It is transversely isotropic. However, because of this definition of the second yield surface, the material can collapse in a shear mode due to low shear resistance. There was no obvious way of increasing the shear resistance without changing the behavior in purely uniaxial compression. Therefore, with the third yield surface, the model has been modified so that the shear and hydrostatic resistance can be prescribed for the material without affecting the uniaxial behavior. The choice of the second yield surface is flagged by the sign of the first load curve ID, LCA. The third yield surface is flagged by the sign of ECCU, which becomes the initial stress yield limit in simple shear. A description is given below.

The development of the second and third yield surfaces are based on experimental test results of aluminum honeycomb specimens at Toyota Motor Corporation.

The default element for this material is solid type 0, a nonlinear spring type solid element. The recommended hourglass control is the type 2 viscous formulation for one point integrated solid elements. The stiffness form of the hourglass control when used with this constitutive model can lead to nonphysical results since strain localization in the shear modes can be inhibited.

This material is available for solid elements and thick shell formulation 3, 5 and 7.

Card Summary:

Card 1. This card is required.

MID	RO	E	PR	SIGY	VF	MU	BULK
-----	----	---	----	------	----	----	------

Card 2. This card is required.

LCA	LCB	LCC	LCS	LCAB	LCBC	LCCA	LCSR
-----	-----	-----	-----	------	------	------	------

Card 3. This card is required.

EAAU	EBBU	ECCU	GABU	GBCU	GCAU	AOPT	MACF
------	------	------	------	------	------	------	------

Card 4. This card is required.

XP	YP	ZP	A1	A2	A3		
----	----	----	----	----	----	--	--

Card 5. This card is required.

D1	D2	D3	TSEF	SSEF	VREF	TREF	SHDFLG
----	----	----	------	------	------	------	--------

Card 6. This card is included if and only if AOPT = 3 or 4 (see Card 3).

V1	V2	V3					
----	----	----	--	--	--	--	--

Card 7. This card is included if and only if LCSR = -1 (see Card 2).

LCSRA	LCSRB	LCSRC	LCSRAB	LCSRBC	LCSCA	LCSRA	LCSRB
-------	-------	-------	--------	--------	-------	-------	-------

Data Card Definitions:

Card 1	1	2	3	4	5	6	7	8
Variable	MID	RO	E	PR	SIGY	VF	MU	BULK
Type	A	F	F	F	F	F	F	F
Default	none	none	none	none	none	none	.05	0.0

VARIABLE

DESCRIPTION

MID	Material identification. A unique number or label must be specified (see *PART).
RO	Mass density
E	Young’s modulus for compacted honeycomb material
PR	Poisson’s ratio for compacted honeycomb material
SIGY	Yield stress for fully compacted honeycomb
VF	Relative volume at which the honeycomb is fully compacted. This field is ignored for corotational solid elements, types 0 and 9.
MU	Material viscosity coefficient, μ . The default value of 0.05 is recommended.
BULK	Bulk viscosity flag: EQ.0.0: Bulk viscosity is not used. This is recommended.

VARIABLE**DESCRIPTION**

EQ.1.0: Bulk viscosity is active and $\mu = 0$. This will give results identical to previous versions of LS-DYNA.

Card 2	1	2	3	4	5	6	7	8
Variable	LCA	LCB	LCC	LCS	LCAB	LCBC	LCCA	LCSR
Type	I	I	I	I	I	I	I	F
Default	none	LCA	LCA	LCA	LCS	LCS	LCS	optional

VARIABLE**DESCRIPTION**

LCA

Load curve ID (see *DEFINE_CURVE):

LT.0: Yield stress as a function of the angle off the material axis in degrees

GT.0: σ_{aa} as a function of normal strain component aa, ε_{aa} . For the corotational solid elements, types 0 and 9, engineering strain is expected, but for all other solid and thick shell element formulations a logarithmic strain is expected. See [Remarks 1](#) and [3](#).

Note that LCA < 0 flags using the second yield surface (the transversely isotropic surface) and determines the definition for LCB, LCC, LCS, LCAB, LCBC, and LCCA.

LCB

Load curve ID (see *DEFINE_CURVE):

LCA.LT.0: Strong axis hardening stress as a function of the volumetric strain

LCA.GT.0: σ_{bb} as a function of normal strain component bb, ε_{bb} . For the corotational solid elements, types 0 and 9, engineering strain is expected, but for all other solid and thick shell element formulations a logarithmic strain is expected. See [Remarks 1](#) and [3](#).

LCC

Load curve ID (see *DEFINE_CURVE):

LCA.LT.0: Weak axis hardening stress as a function of the volumetric strain

VARIABLE	DESCRIPTION
	<p>LCA.GT.0: σ_{cc} as a function of normal strain component cc, ϵ_{cc}. For the corotational solid elements, types 0 and 9, engineering strain is expected, but for all other solid and thick shell element formulations a logarithmic strain is expected. See Remarks 1 and 3.</p>
LCS	<p>Load curve ID (see *DEFINE_CURVE):</p> <p>LCA.LT.0: Damage curve giving the shear stress multiplier as a function of the shear strain component. This curve definition is optional and may be used if damage is desired. IF SHDFLG = 0 (the default), the damage value multiplies the stress every time step and the stress is updated incrementally. The damage curve should be set to unity until failure begins. After failure the value should drop to 0.999 or 0.99 or any number between zero and one depending on how many steps are needed to zero the stress. Alternatively, if SHDFLG = 1, the damage value is treated as a factor that scales the shear stress compared to the undamaged value.</p> <p>LCA.GT.0: Shear stress as a function of shear strain. For the corotational solid elements, types 0 and 9, engineering strain is expected, but for all other solid and thick shell element formulations a shear strain based on the deformed configuration is used. Each component of shear stress may have its own load curve. See Remarks 1 and 3.</p>
LCAB	<p>Load curve ID (see *DEFINE_CURVE):</p> <p>LCA.LT.0: Damage curve giving shear ab-stress multiplier as a function of the ab-shear strain component. This curve definition is optional and may be used if damage is desired. See LCS above.</p> <p>LCA.GT.0: σ_{ab} as a function of shear strain-ab, ϵ_{ab}. For the corotational solid elements, types 0 and 9, engineering strain is expected, but for all other solid and thick shell element formulations a shear strain based on the deformed configuration is used. See Remarks 1 and 3.</p>
LCBC	<p>Load curve ID (see *DEFINE_CURVE):</p>

VARIABLE

DESCRIPTION

LCA.LT.0: Damage curve giving bc -shear stress multiplier as a function of the ab -shear strain component. This curve definition is optional and may be used if damage is desired. See LCS above.

LCA.GT.0: σ_{bc} as a function of shear strain- bc , ϵ_{bc} . For the corotational solid elements, types 0 and 9, engineering strain is expected, but for all other solid and thick shell element formulations a shear strain based on the deformed configuration is used. See [Remarks 1](#) and [3](#).

LCCA

Load curve ID (see *DEFINE_CURVE):

LCA.LT.0: Damage curve giving ca -shear stress multiplier as a function of the ca -shear strain component. This curve definition is optional and may be used if damage is desired. See LCS above.

LCA.GT.0: σ_{ca} as a function of shear strain- ca , ϵ_{ca} . For the corotational solid elements, types 0 and 9, engineering strain is expected, but for all other solid and thick shell element formulations a shear strain based on the deformed configuration is used. See [Remarks 1](#) and [3](#).

LCSR

Load curve ID (see *DEFINE_CURVE) for strain-rate effects defining the scale factor as a function of effective strain rate $\dot{\epsilon} = \sqrt{\frac{2}{3}(\dot{\epsilon}'_{ij}\dot{\epsilon}'_{ij})}$. This is optional. The curves defined above are scaled using this curve. Set LCSR = -1 to define a scale factor in each direction using Card 7.

Card 3	1	2	3	4	5	6	7	8
Variable	EAAU	EBBU	ECCU	GABU	GBCU	GCAU	AOPT	MACF
Type	F	F	F	F	F	F	F	I

VARIABLE	DESCRIPTION
EAAU	Elastic modulus E_{aaU} in uncompressed configuration. LCA.LT.0: Strong axis elastic modulus in uncompressed configuration
EBBU	Elastic modulus E_{bbU} in uncompressed configuration. LCA.LT.0: Weak axis elastic modulus in uncompressed configuration
ECCU	Elastic modulus E_{ccU} in uncompressed configuration. LT.0.0: $ ECCU $ is the initial stress limit (yield) in simple shear, σ_d^Y . $ECCU < 0$ activates the third yield surface if $LCA < 0$.
GABU	Shear modulus G_{abU} in uncompressed configuration. LCA.LT.0: Strong-weak shear modulus in uncompressed configuration
GBCU	Shear modulus G_{bcU} in uncompressed configuration. LCA.LT.0: Weak-weak shear modulus in uncompressed configuration
GCAU	Shear modulus G_{caU} in uncompressed configuration. ECCU.LT.0.0: GCAU is the initial stress limit (yield) in hydrostatic compression, σ_p^Y .
AOPT	Material axes option (see MAT_OPTIONTROPIC_ELASTIC, particularly the Material Directions section, for details): EQ.0.0: Locally orthotropic with material axes determined by element nodes 1, 2, and 4, as with *DEFINE_COORDINATE_NODES. EQ.1.0: Locally orthotropic with material axes determined by a point, P , in space and the global location of the element center; this is the a -direction. This option is for solid elements only. EQ.2.0: Globally orthotropic with material axes determined by vectors defined below, as with *DEFINE_COORDINATE_VECTOR

VARIABLE	DESCRIPTION
	<p>EQ.3.0: Locally orthotropic material axes determined by a vector \mathbf{v} and the normal vector to the plane of the element. The plane of a solid element is the midsurface between the inner surface and outer surface defined by the first four nodes and the last four nodes of the connectivity of the element, respectively. Thus, for solid elements, AOPT = 3 is only available for hexahedrons. \mathbf{a} is determined by taking the cross product of \mathbf{v} with the normal vector, \mathbf{b} is determined by taking the cross product of the normal vector with \mathbf{a}, and \mathbf{c} is the normal vector. Then \mathbf{a} and \mathbf{b} are rotated about \mathbf{c} by an angle BETA. BETA may be set in the keyword input for the element. Note that for solids, the material axes may be switched depending on the choice of MACF. The switch may occur before or after applying BETA depending on the value of MACF.</p> <p>EQ.4.0: Locally orthotropic in a cylindrical coordinate system with the material axes determined by a vector \mathbf{v}, and an originating point, P, which define the centerline axis. This option is for solid elements only.</p> <p>LT.0.0: The absolute value of AOPT is a coordinate system ID number (CID on *DEFINE_COORDINATE_OPTION).</p>
MACF	<p>Material axes change flag for solid elements:</p> <p>EQ.-4: Switch material axes b and c before BETA rotation</p> <p>EQ.-3: Switch material axes a and c before BETA rotation</p> <p>EQ.-2: Switch material axes a and b before BETA rotation</p> <p>EQ.1: No change, default</p> <p>EQ.2: Switch material axes a and b after BETA rotation</p> <p>EQ.3: Switch material axes a and c after BETA rotation</p> <p>EQ.4: Switch material axes b and c after BETA rotation</p> <p>Figure M2-2 indicates when LS-DYNA applies MACF during the process to obtain the final material axes. BETA on *ELEMENT_SOLID_{OPTION} is used to rotate the axes. The BETA rotation is optional.</p>

Card 4	1	2	3	4	5	6	7	8
Variable	XP	YP	ZP	A1	A2	A3		
Type	F	F	F	F	F	F		

VARIABLE**DESCRIPTION**

XP YP ZP Coordinates of point p for AOPT = 1 and 4

A1 A2 A3 Components of vector \mathbf{a} for AOPT = 2

Card 5	1	2	3	4	5	6	7	8
Variable	D1	D2	D3	TSEF	SSEF	VREF	TREF	SHDFLG
Type	F	F	F	F	F	F	F	F

VARIABLE**DESCRIPTION**

D1 D2 D3 Components of vector \mathbf{d} for AOPT = 2.

TSEF Tensile strain at element failure (element will erode)

SSEF Shear strain at element failure (element will erode)

VREF This is an optional input parameter for solid elements types 1, 2, 3, 4, and 10, and thick shell formulations 3, 5, and 7. Relative volume at which the reference geometry is stored. At this time the element behaves like a nonlinear spring. If TREF, below, is reached first, then VREF will have no effect.

TREF This is an optional input parameter for solid elements types 1, 2, 3, 4, and 10, and thick shell formulation 3, 5, and 7. Element time step size at which the reference geometry is stored. When this time step size is reached the element behaves like a nonlinear spring. If VREF, above, is reached first then TREF will have no effect.

VARIABLE	DESCRIPTION
SHDFLG	Flag defining treatment of damage from curves LCS, LCAB, LCBC and LCCA (relevant only when LCA < 0): EQ.0.0: Damage reduces shear stress every time step, EQ.1.0: Damage = (shear stress)/(undamaged shear stress)

Additional card for AOPT = 3 or AOPT = 4.

Card 6	1	2	3	4	5	6	7	8
Variable	V1	V2	V3					
Type	F	F	F					

VARIABLE	DESCRIPTION
V1 V2 V3	Components of vector \mathbf{v} for AOPT = 3 and 4

Additional card for LCSR = -1.0

Card 7	1	2	3	4	5	6	7	8
Variable	LCSRA	LCSR B	LCSRC	LCSRAB	LCSRBC	LCSCA		
Type	F	F	F	F	F	F		

VARIABLE	DESCRIPTION
LCSRA	Optional load curve ID if LCSR = -1 (see *DEFINE_CURVE) for strain rate effects defining the scale factor for the yield stress in the a -direction as a function of the <i>natural logarithm</i> of the absolute value of deviatoric strain rate in the a -direction. The scale factor for the lowest value of strain rate defined by the curve is used if the strain rate is zero. The scale factor for the highest value of strain rate defined by the curve also defines the upper limit of the scale factor.

VARIABLE	DESCRIPTION
LCSRb	Optional load curve ID if LCSR = -1 (see *DEFINE_CURVE) for strain rate effects defining the scale factor for the yield stress in the <i>b</i> -direction as a function of the <i>natural logarithm</i> of the absolute value of deviatoric strain rate in the <i>b</i> -direction. The scale factor for the lowest value of strain rate defined by the curve is used if the strain rate is zero. The scale factor for the highest value of strain rate defined by the curve also defines the upper limit of the scale factor.
LCSRc	Optional load curve ID if LCSR = -1 (see *DEFINE_CURVE) for strain rate effects defining the scale factor for the yield stress in the <i>c</i> -direction as a function of the <i>natural logarithm</i> of the absolute value of deviatoric strain rate in the <i>c</i> -direction. The scale factor for the lowest value of strain rate defined by the curve is used if the strain rate is zero. The scale factor for the highest value of strain rate defined by the curve also defines the upper limit of the scale factor.
LCSRab	Optional load curve ID if LCSR = -1 (see *DEFINE_CURVE) for strain rate effects defining the scale factor for the yield stress in the <i>ab</i> -direction as a function of the <i>natural logarithm</i> of the absolute value of strain rate in the <i>ab</i> -direction. The scale factor for the lowest value of strain rate defined by the curve is used if the strain rate is zero. The scale factor for the highest value of strain rate defined by the curve also defines the upper limit of the scale factor.
LCSRbc	Optional load curve ID if LCSR = -1 (see *DEFINE_CURVE) for strain rate effects defining the scale factor for the yield stress in the <i>bc</i> -direction as a function of the <i>natural logarithm</i> of the absolute value of strain rate in the <i>bc</i> -direction. The scale factor for the lowest value of strain rate defined by the curve is used if the strain rate is zero. The scale factor for the highest value of strain rate defined by the curve also defines the upper limit of the scale factor.
LCSRca	Optional load curve ID if LCSR = -1 (see *DEFINE_CURVE) for strain rate effects defining the scale factor for the yield stress in the <i>ca</i> -direction as a function of the <i>natural logarithm</i> of the absolute value of strain rate in the <i>ca</i> -direction. The scale factor for the lowest value of strain rate defined by the curve is used if the strain rate is zero. The scale factor for the highest value of strain rate defined by the curve also defines the upper limit of the scale factor.

Remarks:

1. **Load Curves and Efficiency.** For efficiency it is strongly recommended that the load curve IDs: LCA, LCB, LCC, LCS, LCAB, LCBC, and LCCA, contain exactly the same number of points with corresponding strain values on the abscissa. If this recommendation is followed, the cost of the table lookup is insignificant. Conversely, the cost increases significantly if the abscissa strain values are not consistent between load curves.
2. **Elastic Moduli.** For solid element formulations 1 and 2, and thick shell formulations 3, 5, and 7, the behavior before compaction is orthotropic where the components of the stress tensor are uncoupled, meaning a component of strain will generate resistance in the local a -direction with no coupling to the local b and c directions. The elastic moduli vary from their initial values to the fully compacted values linearly with the relative volume:

$$\begin{aligned} E_{aa} &= E_{aa0} + \beta(E - E_{aa0}) & G_{ab} &= G_{ab0} + \beta(G - G_{ab0}) \\ E_{bb} &= E_{bb0} + \beta(E - E_{bb0}) & G_{bc} &= G_{bc0} + \beta(G - G_{bc0}) \\ E_{cc} &= E_{cc0} + \beta(E - E_{cc0}) & G_{ca} &= G_{ca0} + \beta(G - G_{ca0}) \end{aligned}$$

where

$$\beta = \max \left[\min \left(\frac{1 - V}{1 - V_f}, 1 \right), 0 \right]$$

and G is the elastic shear modulus for the fully compacted honeycomb material

$$G = \frac{E}{2(1 + \nu)} .$$

The relative volume, V , is defined as the ratio of the current volume over the initial volume, and typically, $V = 1$ at the beginning of a calculation.

For corotational solid elements, types 0 and 9, the components of the stress tensor remain uncoupled and the uncompressed elastic moduli are used, that is, the fully compacted elastic moduli are ignored. However, the Young's modulus and Poisson's ratio input on Card 1 are still used to calculate the element time step size.

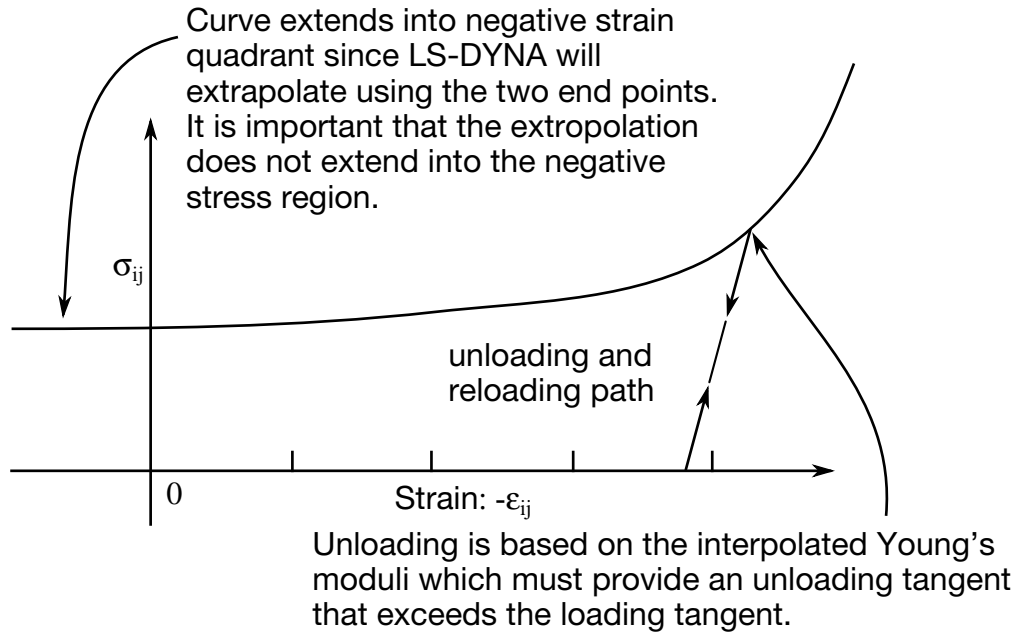

Figure M126-1. Stress as a function of strain. Note that the “yield stress” at a strain of zero is nonzero. In the load curve definition the “time” value is the directional strain and the “function” value is the yield stress. Note that for element types 0 and 9 engineering strains are used, but for all other element types the rates are integrated in time.

- Stress Update for Uncompacted Material.** The load curves define the magnitude of the stress as the material undergoes deformation. The first value in the curve should be less than or equal to zero corresponding to tension and increase to full compaction. *Care should be taken when defining the curves so the extrapolated values do not lead to negative yield stresses.*

At the beginning of the stress update we transform each element’s stresses and strain rates into the local element coordinate system. After completing the stress update we transform the stresses back to the global configuration. For the uncompacted material, the trial stress components are updated using the elastic interpolated moduli according to:

$$\begin{aligned} \sigma_{aa}^{n+1\text{trial}} &= \sigma_{aa}^n + E_{aa}\Delta\epsilon_{aa} & \sigma_{ab}^{n+1\text{trial}} &= \sigma_{ab}^n + 2G_{ab}\Delta\epsilon_{ab} \\ \sigma_{cc}^{n+1\text{trial}} &= \sigma_{cc}^n + E_{cc}\Delta\epsilon_{cc} & \sigma_{bc}^{n+1\text{trial}} &= \sigma_{bc}^n + 2G_{bc}\Delta\epsilon_{bc} \\ \sigma_{bb}^{n+1\text{trial}} &= \sigma_{bb}^n + E_{bb}\Delta\epsilon_{bb} & \sigma_{ca}^{n+1\text{trial}} &= \sigma_{ca}^n + 2G_{ca}\Delta\epsilon_{ca} \end{aligned}$$

If $LCA > 0$, each component of the updated stress tensor is checked to ensure that it does not exceed the permissible value determined from the load curves; for example, if

$$|\sigma_{ij}^{n+1\text{trial}}| > \lambda\sigma_{ij}(\epsilon_{ij}) ,$$

then

$$\sigma_{ij}^{n+1} = \sigma_{ij}(\varepsilon_{ij}) \frac{\lambda \sigma_{ij}^{n+1 \text{ trial}}}{|\sigma_{ij}^{n+1 \text{ trial}}|}$$

On Card 3 $\sigma_{ij}(\varepsilon_{ij})$ is defined in the load curve specified in columns 31-40 for the aa stress component, 41-50 for the bb component, 51-60 for the cc component, and 61-70 for the ab, bc, cb shear stress components. The parameter λ is either unity or a value taken from the load curve number, LCSR, that defines λ as a function of strain-rate. Strain-rate is defined here as the Euclidean norm of the deviatoric strain-rate tensor.

If $LCA < 0$, a transversely isotropic yield surface is obtained where the uniaxial limit stress, $\sigma^y(\varphi, \varepsilon^{\text{vol}})$, can be defined as a function of angle φ with the strong axis and volumetric strain, ε^{vol} . In order to facilitate the input of data to such a limit stress surface, the limit stress is written as:

$$\sigma^y(\varphi, \varepsilon^{\text{vol}}) = \sigma^b(\varphi) + (\cos\varphi)^2 \sigma^s(\varepsilon^{\text{vol}}) + (\sin\varphi)^2 \sigma^w(\varepsilon^{\text{vol}})$$

where the functions σ^b , σ^s , and σ^w are represented by load curves LCA, LCB, LCC, respectively. The latter two curves can be used to include the stiffening effects that are observed as the foam material crushes to the point where it begins to lock up. To ensure that the limit stress decreases with respect to the off-angle the curves should be defined such that following equations hold:

$$\frac{\partial \sigma^b(\varphi)}{\partial \varphi} \leq 0$$

and

$$\sigma^s(\varepsilon^{\text{vol}}) - \sigma^w(\varepsilon^{\text{vol}}) \geq 0.$$

A drawback of this implementation was that the material often collapsed in shear mode due to low shear resistance. There was no way of increasing the shear resistance without changing the behavior in pure uniaxial compression. We have therefore modified the model so that the user can optionally prescribe the shear and hydrostatic resistance in the material without affecting the uniaxial behavior. We introduce the parameters $\sigma_p^Y(\varepsilon^{\text{vol}})$ and $\sigma_d^Y(\varepsilon^{\text{vol}})$ as the *hydrostatic* and *shear limit stresses*, respectively. These are functions of the volumetric strain and are assumed given by

$$\begin{aligned} \sigma_p^Y(\varepsilon^{\text{vol}}) &= \sigma_p^Y + \sigma^s(\varepsilon^{\text{vol}}) \\ \sigma_d^Y(\varepsilon^{\text{vol}}) &= \sigma_d^Y + \sigma^s(\varepsilon^{\text{vol}}) \end{aligned}$$

where we have reused the densification function σ^s . The new parameters are the initial hydrostatic and shear limit stress values, σ_p^Y and σ_d^Y , and are provided by the user as GCAU and |ECCU|, respectively. The negative sign of ECCU flags the third yield surface option whenever $LCA < 0$. The effect of the third

formulation is that (i) for a uniaxial stress the stress limit is given by $\sigma^Y(\phi, \varepsilon^{\text{vol}})$, (ii) for a pressure the stress limit is given by $\sigma_p^Y(\varepsilon^{\text{vol}})$, and (iii) for a simple shear the stress limit is given by $\sigma_d^Y(\varepsilon^{\text{vol}})$. Experiments have shown that the model may give noisy responses and inhomogeneous deformation modes if parameters are not chosen with care. We therefore recommend to (i) avoid large slopes in the function σ^P , (ii) let the functions σ^s and σ^w be slightly increasing, and (iii) avoid large differences between the stress limit values $\sigma^y(\phi, \varepsilon^{\text{vol}})$, $\sigma_p^Y(\varepsilon^{\text{vol}})$ and $\sigma_d^Y(\varepsilon^{\text{vol}})$. These guidelines are likely to contradict how one would interpret test data and it is up to the user to find a reasonable trade-off between matching experimental results and avoiding the mentioned numerical side effects.

4. **Stress Update for Fully Compacted Material.** As in the uncompacted case, we transform each element's stresses and strain rates into the local element coordinate system. For fully compacted material (element formulations 1 and 2), we assume that the material behavior is elastic-perfectly plastic and updated the stress components according to:

$$s_{ij}^{\text{trial}} = s_{ij}^n + 2G\Delta\varepsilon_{ij}^{\text{dev}^{n+1/2}}$$

where the deviatoric strain increment is defined as

$$\Delta\varepsilon_{ij}^{\text{dev}} = \Delta\varepsilon_{ij} - \frac{1}{3}\Delta\varepsilon_{kk}\delta_{ij}.$$

We now check to see if the yield stress for the fully compacted material is exceeded by comparing

$$s_{\text{eff}}^{\text{trial}} = \left(\frac{3}{2} s_{ij}^{\text{trial}} s_{ij}^{\text{trial}} \right)^{1/2}$$

the effective trial stress to the yield stress, σ_y (Card 1, field 41-50). If the effective trial stress exceeds the yield stress we simply scale back the stress components to the yield surface

$$s_{ij}^{n+1} = \frac{\sigma_y}{s_{\text{eff}}^{\text{trial}}} s_{ij}^{\text{trial}}.$$

We can now update the pressure using the elastic bulk modulus, K

$$p^{n+1} = p^n - K\Delta\varepsilon_{kk}^{n+1/2}$$

$$K = \frac{E}{3(1-2\nu)}$$

and obtain the final value for the Cauchy stress

$$\sigma_{ij}^{n+1} = s_{ij}^{n+1} - p^{n+1}\delta_{ij}$$

After completing the stress update, we transform the stresses back to the global configuration.

5. **Failure.** For *CONSTRAINED_TIED_NODES_WITH_FAILURE, the failure is based on the volume strain instead to the plastic strain.

***MAT_ARRUDA_BOYCE_RUBBER**

This is Material Type 127. This material model provides a hyperelastic rubber model (see [Arruda and Boyce 1993]) combined optionally with linear viscoelasticity as outlined by [Christensen 1980].

Card 1	1	2	3	4	5	6	7	8
Variable	MID	RO	K	G	N			
Type	A	F	F	F	F			

Card 2	1	2	3	4	5	6	7	8
Variable	LCID	TRAMP	NT					
Type	F	F	F					

Viscoelastic Constant Cards. Up to 6 cards may be input. The next keyword (“*”) card terminates this input.

Card 3	1	2	3	4	5	6	7	8
Variable	G_i	BETA $_i$						
Type	F	F						

VARIABLE**DESCRIPTION**

MID	Material identification. A unique number or label must be specified (see *PART).
RO	Mass density
K	Bulk modulus
G	Shear modulus
N	Number of statistical links

VARIABLE	DESCRIPTION
LCID	Optional load curve ID of relaxation curve if constants G_i and β_i are determined using a least squares fit. This relaxation curve is shown in Figure M76-1 . This model ignores the constant stress.
TRAMP	Optional ramp time for loading
NT	Number of Prony series terms in optional fit. If zero, the default is 6. Currently, the maximum number is 6. Values less than 6, possibly 3-5 are recommended, since each term used adds significantly to the cost. Caution should be exercised when taking the results from the fit. Always check the results of the fit in the output file. Preferably, all generated coefficients should be positive. Negative values may lead to unstable results. Once a satisfactory fit has been achieved, it is recommended that the coefficients which are written into the output file be input in future runs.
G_i	Optional shear relaxation modulus for the i^{th} term.
BETA i	Optional decay constant if i^{th} term.

Remarks:

Rubber is generally considered to be fully incompressible since the bulk modulus greatly exceeds the shear modulus in magnitude. To model the rubber as an unconstrained material a hydrostatic work term, $W_H(J)$, is included in the strain energy functional which is function of the relative volume, J , [Ogden 1984]:

$$W(J_1, J_2, J) = nk\theta \left[\frac{1}{2} (J_1 - 3) + \frac{1}{20N} (J_1^2 - 9) + \frac{11}{1050N^2} (J_1^3 - 27) \right] \\ + nk\theta \left[\frac{19}{7000N^3} (J_1^4 - 81) + \frac{519}{673750N^4} (J_1^5 - 243) \right] + W_H(J) ,$$

where the hydrostatic work term is in terms of the bulk modulus, K , and the third invariant, J , as:

$$W_H(J) = \frac{K}{2} (J - 1)^2$$

Rate effects are taken into account through linear viscoelasticity by a convolution integral of the form:

$$\sigma_{ij} = \int_0^t g_{ijkl}(t - \tau) \frac{\partial \varepsilon_{kl}}{\partial \tau} d\tau ,$$

or in terms of the second Piola-Kirchhoff stress, S_{ij} , and Green's strain tensor, E_{ij} ,

$$S_{ij} = \int_0^t G_{ijkl}(t - \tau) \frac{\partial E_{kl}}{\partial \tau} d\tau ,$$

where $g_{ijkl}(t - \tau)$ and $G_{ijkl}(t - \tau)$ are the relaxation functions for the different stress measures. This stress is added to the stress tensor determined from the strain energy functional.

If we wish to include only simple rate effects, the relaxation function is represented by up to six terms from the Prony series:

$$g(t) = \alpha_0 + \sum_{m=1}^N \alpha_m e^{-\beta_m t}$$

given by,

$$g(t) = \sum_{i=1}^n G_i e^{-\beta_i t} .$$

This model is effectively a Maxwell fluid which consists of a dampers and springs in series. We characterize this in the input by shear moduli, G_i , and decay constants, β_i . The viscoelastic behavior is optional and an arbitrary number of terms may be used.

***MAT_HEART_TISSUE**

This is Material Type 128. This material model provides a heart tissue model described in the paper by Walker *et al* [2005] as interpreted by Kay Sun. It is backward compatible with an earlier heart tissue model described in the paper by Guccione, McCulloch, and Waldman [1991]. Both models are transversely isotropic.

Card 1	1	2	3	4	5	6	7	8
Variable	MID	RO	C	B1	B2	B3	P	B
Type	A	F	F	F	F	F	F	F

Skip to Card 3 to activate older Guccione, McCulloch, and Waldman [1991] model.

Card 2	1	2	3	4	5	6	7	8
Variable	L0	CA0MAX	LR	M	BB	CA0	TMAX	TACT
Type	F	I	F	F	F	F	F	F

Card 3	1	2	3	4	5	6	7	8
Variable	AOPT	MACF						
Type	F	I						

Card 4	1	2	3	4	5	6	7	8
Variable	XP	YP	ZP	A1	A2	A3		
Type	F	F	F	F	F	F		

Card 5	1	2	3	4	5	6	7	8
Variable	V1	V2	V3	D1	D2	D3	BETA	
Type	F	F	F	F	F	F	F	

VARIABLE**DESCRIPTION**

MID	Material identification. A unique number or label must be specified (see *PART).
RO	Mass density
C	Diastolic material coefficient
B1	b_1 , diastolic material coefficient
B2	b_2 , diastolic material coefficient
B3	b_3 , diastolic material coefficient
P	Pressure in the muscle tissue
B	Systolic material coefficient. Omit for the earlier model.
L0	l_0 , sarcomere length at which no active tension develops. Omit for the earlier model.
CA0MAX	$(Ca_0)_{max}$, maximum peak intracellular calcium concentrate. Omit for the earlier model.
LR	l_R , Stress-free sarcomere length. Omit for the earlier model.
M	Systolic material coefficient. Omit for the earlier model.
BB	Systolic material coefficient. Omit for the earlier model.
CA0	Ca_0 , peak intracellular calcium concentration. Omit for the earlier model.
TMAX	T_{max} , maximum isometric tension achieved at the longest sarcomere length. Omit for the earlier model.
TACT	t_{act} , time at which active contraction initiates. Omit for the earlier model

VARIABLE	DESCRIPTION
AOPT	<p>Material axes option (see MAT_OPTIONTROPIC_ELASTIC, particularly the Material Directions section, for details):</p> <p>EQ.0.0: Locally orthotropic with material axes determined by element nodes 1, 2, and 4, as with *DEFINE_COORDINATE_NODES.</p> <p>EQ.1.0: Locally orthotropic with material axes determined by a point, P, in space and the global location of the element center; this is the \mathbf{a}-direction. This option is for solid elements only.</p> <p>EQ.2.0: Globally orthotropic with material axes determined by vectors defined below, as with *DEFINE_COORDINATE_VECTOR</p> <p>EQ.3.0: Locally orthotropic material axes determined by a vector \mathbf{v} and the normal vector to the plane of the element. The plane of a solid element is the midsurface between the inner surface and outer surface defined by the first four nodes and the last four nodes of the connectivity of the element, respectively. Thus, for solid elements, AOPT = 3 is only available for hexahedrons. \mathbf{a} is determined by taking the cross product of \mathbf{v} with the normal vector, \mathbf{b} is determined by taking the cross product of the normal vector with \mathbf{a}, and \mathbf{c} is the normal vector. Then \mathbf{a} and \mathbf{b} are rotated about \mathbf{c} by an angle BETA. BETA may be set in the keyword input for the element or in the input for this keyword. Note that for solids, the material axes may be switched depending on the choice of MACF. The switch may occur before or after applying BETA depending on the value of MACF.</p> <p>EQ.4.0: Locally orthotropic in a cylindrical coordinate system with the material axes determined by a vector \mathbf{v}, and an originating point, P, which define the centerline axis. This option is for solid elements only.</p> <p>LT.0.0: The absolute value of AOPT is a coordinate system ID number (CID on *DEFINE_COORDINATE_OPTION).</p>
MACF	<p>Material axes change flag for solid elements:</p> <p>EQ.-4: Switch material axes b and c before BETA rotation</p> <p>EQ.-3: Switch material axes a and c before BETA rotation</p> <p>EQ.-2: Switch material axes a and b before BETA rotation</p>

VARIABLE	DESCRIPTION
	EQ.1: No change, default
	EQ.2: Switch material axes <i>a</i> and <i>b</i> after BETA rotation
	EQ.3: Switch material axes <i>a</i> and <i>c</i> after BETA rotation
	EQ.4: Switch material axes <i>b</i> and <i>c</i> after BETA rotation
	Figure M2-2 indicates when LS-DYNA applies MACF during the process to obtain the final material axes. If BETA on *ELEMENT_SOLID_{OPTION} is defined, then that BETA is used for the rotation for all AOPT options. Otherwise, if AOPT = 3, the BETA input on Card 5 rotates the axes. For all other values of AOPT, the material axes will be switched as specified by MACF, but no BETA rotation will be performed.
XP, YP, ZP	Coordinates of point <i>p</i> for AOPT = 1 and 4
A1, A2, A3	Components of vector a for AOPT = 2
D1, D2, D3	Components of vector d for AOPT = 2
V1, V2, V3	Components of vector v for AOPT = 3 and 4
BETA	Material angle in degrees for AOPT = 3. BETA may be overridden on the element card; see *ELEMENT_SOLID_ORTHO.

Remarks:

1. **Tissue Model.** The tissue model is described in terms of the energy functional that is transversely isotropic with respect to the local fiber direction,

$$W = \frac{C}{2} (e^Q - 1)$$

$$Q = b_f E_{11}^2 + b_t (E_{22}^2 + E_{33}^2 + E_{23}^2 + E_{32}^2) + b_{fs} (E_{12}^2 + E_{21}^2 + E_{13}^2 + E_{31}^2)$$

Here *C*, *b_f*, *b_t*, and *b_{fs}* are material parameters and **E** is the Lagrange-Green strain.

The systolic contraction is modeled as the sum of the passive stress derived from the strain energy function and an active fiber directional component, *T₀*, which is a function of time, *t*,

$$\mathbf{S} = \frac{\partial W}{\partial \mathbf{E}} - pJ\mathbf{C}^{-1} + T_0\{t, Ca_0, l\}$$

$$\boldsymbol{\sigma} = \frac{1}{J} \mathbf{F}\mathbf{S}\mathbf{F}^T$$

with \mathbf{S} , the second Piola-Kirchoff stress tensor; \mathbf{C} , the right Cauchy-Green deformation tensor; J , the Jacobian of the deformation gradient tensor \mathbf{F} ; and σ , the Cauchy stress tensor.

The active fiber directional stress component is defined by a time-varying elastance model, which at end-systole, is reduced to

$$T_0 = T_{\max} \frac{Ca_0^2}{Ca_0^2 + ECa_{50}^2} C_t$$

Here, T_{\max} is the maximum isometric tension achieved at the longest sarcomere length and maximum peak intracellular calcium concentration. The length-dependent calcium sensitivity and internal variable is given by,

$$\begin{aligned} ECa_{50} &= \frac{(Ca_0)_{\max}}{\sqrt{\exp[B(l - l_0)] - 1}} \\ C_t &= 1/2(1 - \cos w) \\ l &= l_R \sqrt{2E_{11} + 1} \\ w &= \pi \frac{0.25 + t_r}{t_r} \\ t_r &= ml + bb \end{aligned}$$

A cross-fiber, in-plane stress equivalent to 40% of that along the myocardial fiber direction is added.

2. **Older Tissue Model.** The earlier tissue model is described in terms of the energy functional in terms of the Green strain components, E_{ij} ,

$$\begin{aligned} W(E) &= \frac{C}{2} (e^Q - 1) + \frac{1}{2} P(I_3 - 1) \\ Q &= b_1 E_{11}^2 + b_2 (E_{22}^2 + E_{33}^2 + E_{23}^2 + E_{32}^2) + b_3 (E_{12}^2 + E_{21}^2 + E_{13}^2 + E_{31}^2) \end{aligned}$$

The Green components are modified to eliminate any effects of volumetric work following the procedures of Ogden. See the paper by Guccione *et al* [1991] for more detail.

***MAT_LUNG_TISSUE**

This is Material Type 129. This material model provides a hyperelastic model for heart tissue, see [Vawter 1980] combined optionally with linear viscoelasticity as outlined by [Christensen 1980].

Card 1	1	2	3	4	5	6	7	8
Variable	MID	RO	K	C	DELTA	ALPHA	BETA	
Type	A	F	F	F	F	F	F	

Card 2	1	2	3	4	5	6	7	8
Variable	C1	C2	LCID	TRAMP	NT			
Type	F	F	F	F	F			

Viscoelastic Constant Cards. Up to 6 cards may be input. A keyword card (with a "*" in column 1) terminates this input if less than 6 cards are used.

Card 3	1	2	3	4	5	6	7	8
Variable	GI	BETA1						
Type	F	F						

VARIABLE**DESCRIPTION**

MID	Material identification. A unique number or label must be specified (see *PART).
RO	Mass density
K	Bulk modulus
C	Material coefficient.
DELTA	Δ , material coefficient.
ALPHA	α , material coefficient.

VARIABLE	DESCRIPTION
BETA	β , material coefficient.
C1	Material coefficient.
C2	Material coefficient.
LCID	Optional load curve ID of relaxation curve If constants G_i and β_i are determined via a least squares fit. This relaxation curve is shown in Figure M76-1 . This model ignores the constant stress.
TRAMP	Optional ramp time for loading.
NT	Number of Prony series terms in optional fit. If zero, the default is 6. Currently, the maximum number is 6. Values less than 6, possibly 3 - 5 are recommended, since each term used adds significantly to the cost. Caution should be exercised when taking the results from the fit. Always check the results of the fit in the output file. Preferably, all generated coefficients should be positive. Negative values may lead to unstable results. Once a satisfactory fit has been achieved it is recommended that the coefficients which are written into the output file be input in future runs.
G_i	Optional shear relaxation modulus for the i^{th} term
BETA i	Optional decay constant if i^{th} term

Remarks:

The material is described by a strain energy functional expressed in terms of the invariants of the Green Strain:

$$W(I_1, I_2) = \frac{C}{2\Delta} e^{(\alpha I_1^2 + \beta I_2)} + \frac{12C_1}{\Delta(1 + C_2)} [A^{(1+C_2)} - 1]$$

$$A^2 = \frac{4}{3} (I_1 + I_2) - 1$$

where the hydrostatic work term is in terms of the bulk modulus, K , and the third invariant, J , as:

$$W_H(J) = \frac{K}{2} (J - 1)^2$$

Rate effects are taken into account through linear viscoelasticity by a convolution integral of the form:

$$\sigma_{ij} = \int_0^t g_{ijkl}(t - \tau) \frac{\partial \varepsilon_{kl}}{\partial \tau} d\tau$$

or in terms of the second Piola-Kirchhoff stress, S_{ij} , and Green's strain tensor, E_{ij} ,

$$S_{ij} = \int_0^t G_{ijkl}(t - \tau) \frac{\partial E_{kl}}{\partial \tau} d\tau$$

where $g_{ijkl}(t - \tau)$ and $G_{ijkl}(t - \tau)$ are the relaxation functions for the different stress measures. This stress is added to the stress tensor determined from the strain energy functional.

If we wish to include only simple rate effects, the relaxation function is represented by six terms from the Prony series:

$$g(t) = \alpha_0 + \sum_{m=1}^N \alpha_m e^{-\beta t}$$

given by,

$$g(t) = \sum_{i=1}^n G_i e^{-\beta_i t}$$

This model is effectively a Maxwell fluid which consists of a dampers and springs in series. We characterize this in the input by shear moduli, G_i , and decay constants, β_i . The viscoelastic behavior is optional and an arbitrary number of terms may be used.

*MAT_SPECIAL_ORTHOTROPIC

This is Material Type 130. This model is available for Belytschko-Tsay and C0 triangular shell elements. It is based on a resultant stress formulation. In-plane behavior is treated separately from bending in order to model perforated materials, such as television shadow masks. If other shell formulations are specified, the formulation will be automatically switched to Belytschko-Tsay. As implemented, this material model cannot be used with user defined integration rules.

NOTE: This material does not support specification of a material angle, β_i , for each through-thickness integration point of a shell.

Card 1	1	2	3	4	5	6	7	8
Variable	MID	RO	YS	EP				
Type	A	F	F	F				

Card 2	1	2	3	4	5	6	7	8
Variable	E11P	E22P	V12P	V21P	G12P	G23P	G31P	
Type	F	F	F	F	F	F	F	

Card 3	1	2	3	4	5	6	7	8
Variable	E11B	E22B	V12B	V21B	G12B	A0PT		
Type	F	F	F	F	F	F		

Card 4	1	2	3	4	5	6	7	8
Variable				A1	A2	A3		
Type				F	F	F		

Card 5	1	2	3	4	5	6	7	8
Variable	V1	V2	V3	D1	D2	D3	BETA	
Type	F	F	F	F	F	F	F	

VARIABLE**DESCRIPTION**

MID	Material identification. A unique number or label must be specified (see *PART).
RO	Mass density
YS	Yield stress. This parameter is optional and approximates the yield condition. Set to zero if the behavior is elastic.
EP	Plastic hardening modulus
E11P	E_{11p} , for in plane behavior
E22P	E_{22p} , for in plane behavior
V12P	ν_{12p} , for in plane behavior.
V11P	ν_{11p} , for in plane behavior
G12P	G_{12p} , for in plane behavior
G23P	G_{23p} , for in plane behavior
G31P	G_{31p} , for in plane behavior
E11B	E_{11b} , for bending behavior
E22B	E_{22b} , for bending behavior
V12B	ν_{12b} , for bending behavior
V21B	ν_{21b} , for bending behavior
G12B	G_{12b} , for bending behavior

VARIABLE	DESCRIPTION
AOPT	<p>Material axes option (see MAT_{OPTION}TROPIC_ELASTIC for a more complete description):</p> <p>EQ.0.0: Locally orthotropic with material axes determined by element nodes 1, 2, and 4, as with *DEFINE_COORDINATE_NODES, and then rotated about the shell element normal by an angle BETA</p> <p>EQ.2.0: Globally orthotropic with material axes determined by vectors defined below, as with *DEFINE_COORDINATE_VECTOR</p> <p>EQ.3.0: Locally orthotropic material axes determined by rotating the material axes about the element normal by an angle, BETA, from a line in the plane of the element defined by the cross product of the vector \mathbf{v} with the element normal</p> <p>LT.0.0: The absolute value of AOPT is a coordinate system ID number (CID on *DEFINE_COORDINATE_NODES, *DEFINE_COORDINATE_SYSTEM or *DEFINE_COORDINATE_VECTOR).</p>
A1, A2, A3	Components of vector \mathbf{a} for AOPT = 2
D1, D2, D3	Components of vector \mathbf{d} for AOPT = 2
V1, V2, V3	Components of vector \mathbf{v} for AOPT = 3
BETA	Material angle in degrees for AOPT = 0 and 3. It may be overridden on the element card; see *ELEMENT_SHELL_BETA.

Remarks:

The in-plane elastic matrix for in-plane, plane stress behavior is given by:

$$\mathbf{C}_{\text{in plane}} = \begin{bmatrix} Q_{11p} & Q_{12p} & 0 & 0 & 0 \\ Q_{12p} & Q_{22p} & 0 & 0 & 0 \\ 0 & 0 & Q_{44p} & 0 & 0 \\ 0 & 0 & 0 & Q_{55p} & 0 \\ 0 & 0 & 0 & 0 & Q_{66p} \end{bmatrix}$$

The terms Q_{ijp} are defined as:

$$Q_{11p} = \frac{E_{11p}}{1 - \nu_{12p}\nu_{21p}}$$

$$Q_{22p} = \frac{E_{22p}}{1 - \nu_{12p}\nu_{21p}}$$

$$Q_{12p} = \frac{\nu_{21p}E_{11p}}{1 - \nu_{12p}\nu_{21p}}$$

$$Q_{44p} = G_{12p}$$

$$Q_{55p} = G_{23p}$$

$$Q_{66p} = G_{31p}$$

The elastic matrix for bending behavior is given by:

$$\mathbf{C}_{\text{bending}} = \begin{bmatrix} Q_{11b} & Q_{12b} & 0 \\ Q_{12b} & Q_{22b} & 0 \\ 0 & 0 & Q_{44b} \end{bmatrix}$$

The terms Q_{ijb} are similarly defined.

Because this is a resultant formulation, nothing is written to the six stress slots of d3plot. Resultant forces and moments may be written to elout and to dynain in place of the six stresses. The first two extra history variables may be used to complete output of the eight resultants to elout and dynain.

***MAT_ISOTROPIC_SMEARED_CRACK**

This is Material Type 131. This model was developed by Lemmen and Meijer [2001] as a smeared crack model for isotropic materials. This model is available of solid elements only and is restricted to cracks in the xy -plane. Users should choose other models unless they have the report by Lemmen and Meijer [2001].

Card 1	1	2	3	4	5	6	7	8
Variable	MID	RO	E	PR	ISPL	SIGF	GK	SR
Type	A	F	F	F	I	F	F	F

VARIABLE**DESCRIPTION**

MID	Material identification. A unique number or label must be specified (see *PART).
RO	Mass density
E	Young's modulus
PR	Poisson's ratio
ISPL	Failure option: EQ.0: Maximum principal stress criterion EQ.5: Smeared crack model EQ.6: Damage model based on modified von Mises strain
SIGF	Peak stress
GK	Critical energy release rate
SR	Strength ratio

Remarks:

The following documentation is taken nearly verbatim from the documentation of Lemmen and Meijer [2001].

Three methods are offered to model progressive failure. The maximum principal stress criterion detects failure if the maximum (most tensile) principal stress exceeds σ_{\max} . Upon failure, the material can no longer carry stress.

The second failure model is the smeared crack model with linear softening stress-strain using equivalent uniaxial strains. Failure is assumed to be perpendicular to the principal strain directions. A rotational crack concept is employed in which the crack directions are related to the current directions of principal strain. Therefore, crack directions may rotate in time. Principal stresses are expressed as

$$\begin{pmatrix} \sigma_1 \\ \sigma_2 \\ \sigma_3 \end{pmatrix} = \begin{bmatrix} \bar{E}_1 & 0 & 0 \\ 0 & \bar{E}_2 & 0 \\ 0 & 0 & \bar{E}_3 \end{bmatrix} \begin{pmatrix} \tilde{\epsilon}_1 \\ \tilde{\epsilon}_2 \\ \tilde{\epsilon}_3 \end{pmatrix} = \begin{pmatrix} \bar{E}_1 \tilde{\epsilon}_1 \\ \bar{E}_2 \tilde{\epsilon}_2 \\ \bar{E}_3 \tilde{\epsilon}_3 \end{pmatrix} \quad (131.1)$$

with \bar{E}_1 , \bar{E}_2 and \bar{E}_3 as secant stiffness in the terms that depend on internal variables.

In the model developed for DYCOSS it has been assumed that there is no interaction between the three directions in which case stresses simply follow from

$$\sigma_j(\tilde{\epsilon}_j) = \begin{cases} E\tilde{\epsilon}_j & \text{if } 0 \leq \tilde{\epsilon}_j \leq \tilde{\epsilon}_{j,\text{ini}} \\ \bar{\sigma} \left(1 - \frac{\tilde{\epsilon}_j - \tilde{\epsilon}_{j,\text{ini}}}{\tilde{\epsilon}_{j,\text{ult}} - \tilde{\epsilon}_{j,\text{ini}}} \right) & \text{if } \tilde{\epsilon}_{j,\text{ini}} < \tilde{\epsilon}_j \leq \tilde{\epsilon}_{j,\text{ult}} \\ 0 & \text{if } \tilde{\epsilon}_j > \tilde{\epsilon}_{j,\text{ult}} \end{cases} \quad (131.2)$$

with $\bar{\sigma}$ the ultimate stress, $\tilde{\epsilon}_{j,\text{ini}}$ the damage threshold, and $\tilde{\epsilon}_{j,\text{ult}}$ the ultimate strain in j -direction. The damage threshold is defined as

$$\tilde{\epsilon}_{j,\text{ini}} = \frac{\bar{\sigma}}{E} . \quad (131.3)$$

The ultimate strain is obtained by relating the crack growth energy and the dissipated energy

$$\int \int \bar{\sigma} d\tilde{\epsilon}_{j,\text{ult}} dV = GA \quad (131.4)$$

with G as the energy release rate, V as the element volume and A as the area perpendicular to the principal strain direction. The one point elements in LS-DYNA have a single integration point and the integral over the volume may be replaced by the volume. For linear softening it follows

$$\tilde{\epsilon}_{j,\text{ult}} = \frac{2GA}{V\bar{\sigma}} . \quad (131.5)$$

The above formulation may be regarded as a damage equivalent to the maximum principle stress criterion.

The third model is a damage model represented by Brekelmans et. al [1991]. Here the Cauchy stress tensor, σ , is expressed as

$$\sigma = (1 - D)E\epsilon \quad (131.6)$$

where D represents the current damage and the factor $1 - D$ is the reduction factor caused by damage. The scalar damage variable is expressed as function of a so-called damage equivalent strain ϵ_d

$$D = D(\varepsilon_d) = 1 - \frac{\varepsilon_{ini}(\varepsilon_{ult} - \varepsilon_d)}{\varepsilon_d(\varepsilon_{ult} - \varepsilon_{ini})} , \quad (131.7)$$

where

$$\varepsilon_d = \frac{k-1}{2k(1-2\nu)} J_1 + \frac{1}{2k} \sqrt{\left(\frac{k-1}{1-2\nu} J_1\right)^2 + \frac{6k}{(1+\nu)^2} J_2} . \quad (131.8)$$

Here the constant k represents the ratio of the strength in tension over the strength in compression

$$k = \frac{\sigma_{ult, tension}}{\sigma_{ult, compression}} , \quad (131.9)$$

J_1 and J_2 are the first and second invariant of the strain tensor representing the volumetric and the deviatoric straining, respectively

$$\begin{aligned} J_1 &= \text{tr}(\varepsilon) \\ J_2 &= \text{tr}(\varepsilon \cdot \varepsilon) - \frac{1}{3} [\text{tr}(\varepsilon)]^2 \end{aligned} \quad (131.10)$$

If the compression and tension strength are equal, the dependency on the volumetric strain vanishes in (131.8) and failure is shear dominated. If the compressive strength is much larger than the strength in tension, k becomes small and the J_1 terms in (131.8) dominate the behavior.

***MAT_ORTHOTROPIC_SMEARED_CRACK**

This is Material Type 132. This material is a smeared crack model for orthotropic materials. It is available for solid elements.

Card 1	1	2	3	4	5	6	7	8
Variable	MID	RO	EA	EB	EC	PRBA	PRCA	PRCB
Type	A	F	F	F	F	F	F	F

Card 2	1	2	3	4	5	6	7	8
Variable	UINS	UISS	CERRMI	CERRMII	IND	ISD		
Type	F	F	F	F	I	I		

Card 3	1	2	3	4	5	6	7	8
Variable	GAB	GBC	GCA	AOPT				
Type	F	F	F	F				

Card 4	1	2	3	4	5	6	7	8
Variable	XP	YP	ZP	A1	A2	A3	MACF	
Type	F	F	F	F	F	F	I	

Card 5	1	2	3	4	5	6	7	8
Variable	V1	V2	V3	D1	D2	D3	BETA	REF
Type	F	F	F	F	F	F	F	F

VARIABLE	DESCRIPTION
MID	Material identification. A unique number or label must be specified (see *PART).
RO	Mass density.
EA	Young's modulus in a -direction, E_a
EB	Young's modulus in b -direction, E_b
EC	Young's modulus in c -direction, E_c
PRBA	Poisson's ratio ba , ν_{ba}
PRCA	Poisson's ratio ca , ν_{ca}
PRCB	Poisson's ratio cb , ν_{cb}
UINS	Ultimate interlaminar normal stress
UISS	Ultimate interlaminar shear stress
CERRMI	Critical energy release rate mode I
CERRMII	Critical energy release rate mode II
IND	Interlaminar normal direction: EQ.1.0: Along local a -axis EQ.2.0: Along local b -axis EQ.3.0: Along local c -axis
ISD	Interlaminar shear direction : EQ.4.0: Along local ab -axis EQ.5.0: Along local bc -axis EQ.6.0: Along local ca -axis
GAB	Shear modulus ab , G_{ab}
GBC	Shear modulus bc , G_{bc}
GCA	Shear modulus ca , G_{ca}
AOPT	Material axes option (see MAT_OPTIONTROPIC_ELASTIC, particularly the Material Directions section, for details):

VARIABLE	DESCRIPTION
	EQ.0.0: Locally orthotropic with material axes determined by element nodes 1, 2, and 4, as with *DEFINE_COORDINATE_NODES.
	EQ.1.0: Locally orthotropic with material axes determined by a point, P , in space and the global location of the element center; this is the \mathbf{a} -direction.
	EQ.2.0: Globally orthotropic with material axes determined by vectors defined below, as with *DEFINE_COORDINATE_VECTOR
	EQ.3.0: Locally orthotropic material axes determined by a vector \mathbf{v} and the normal vector to the plane of the element. The plane of a solid element is the midsurface between the inner surface and outer surface defined by the first four nodes and the last four nodes of the connectivity of the element, respectively. Thus, AOPT = 3 is only available for hexahedrons. \mathbf{a} is determined by taking the cross product of \mathbf{v} with the normal vector, \mathbf{b} is determined by taking the cross product of the normal vector with \mathbf{a} , and \mathbf{c} is the normal vector. Then \mathbf{a} and \mathbf{b} are rotated about \mathbf{c} by an angle BETA. BETA may be set in the keyword input for the element or in the input for this keyword. Note that the material axes may be switched depending on the choice of MACF. The switch may occur before or after applying BETA depending on the value of MACF.
	EQ.4.0: Locally orthotropic in a cylindrical coordinate system with the material axes determined by a vector \mathbf{v} , and an originating point, P , which define the centerline axis.
	LT.0.0: The absolute value of AOPT is a coordinate system ID number (CID on *DEFINE_COORDINATE_OPTION).
XP YP ZP	Define coordinates of point P for AOPT = 1 and 4.
A1 A2 A3	Define components of vector \mathbf{a} for AOPT = 2.
MACF	Material axes change flag for solid elements: EQ.-4: Switch material axes b and c before BETA rotation EQ.-3: Switch material axes a and c before BETA rotation EQ.-2: Switch material axes a and b before BETA rotation

VARIABLE	DESCRIPTION
	EQ.1: No change, default EQ.2: Switch material axes <i>a</i> and <i>b</i> after BETA rotation EQ.3: Switch material axes <i>a</i> and <i>c</i> after BETA rotation EQ.4: Switch material axes <i>b</i> and <i>c</i> after BETA rotation
	Figure M2-2 indicates when LS-DYNA applies MACF during the process to obtain the final material axes. If BETA on *ELEMENT_SOLID_{OPTION} is defined, then that BETA is used for the rotation for all AOPT options. Otherwise, if AOPT = 3, the BETA input on Card 5 rotates the axes. For all other values of AOPT, the material axes will be switched as specified by MACF, but no BETA rotation will be performed.
V1 V2 V3	Define components of vector v for AOPT = 3 and 4.
D1 D2 D3	Define components of vector d for AOPT = 2:
BETA	Material angle in degrees for AOPT = 3. It may be overridden on the element card; see *ELEMENT_SOLID_ORTHO.
REF	Use reference geometry to initialize the stress tensor. The reference geometry is defined by the keyword *INITIAL_FOAM_REFERENCE_GEOMETRY. EQ.0.0: Off EQ.1.0: On

Remarks:

This is an orthotropic material with optional delamination failure for brittle composites. The elastic formulation is identical to the DYNA3D model that uses total strain formulation. The constitutive matrix **C** that relates to global components of stress to the global components of strain is defined as:

$$\mathbf{C} = \mathbf{T}^T \mathbf{C}_L \mathbf{T}$$

where **T** is the transformation matrix between the local material coordinate system and the global system and **C_L** is the constitutive matrix defined in terms of the material constants of the local orthogonal material axes *a*, *b*, and *c* (see DYNA3D use manual).

Failure is described using linear softening stress strain curves for the interlaminar normal and interlaminar shear directions. The current implementation for failure is essentially two-dimensional. Damage can occur in the interlaminar normal direction and a single

interlaminar shear direction. The orientation of these directions with respect to the principal material directions must be specified by the user.

Based on specified values for the ultimate stress and the critical energy release rate bounding surfaces are defined as

$$\begin{aligned} f_n &= \sigma_n - \bar{\sigma}_n(\epsilon_n) \\ f_s &= \sigma_s - \bar{\sigma}_s(\epsilon_s) \end{aligned}$$

where the subscripts n and s refer to the normal and shear component. If stresses exceed the bounding surfaces, inelastic straining occurs. The ultimate strain is obtained by relating the crack growth energy and the dissipated energy. For solid elements with a single integration point it can be derived to obtain

$$\epsilon_{i,ult} = \frac{2G_i A}{V\sigma_{i,ult}}$$

with G_i as the critical energy release rate, V as the element volume, A as the area perpendicular to the active normal direction and $\sigma_{i,ult}$ as the ultimate stress. For the normal component failure can only occur under tensile loading. For the shear component the behavior is symmetric around zero. The resulting stress bounds are depicted in [Figure M132-1](#). Unloading is modeled with a Secant stiffness.

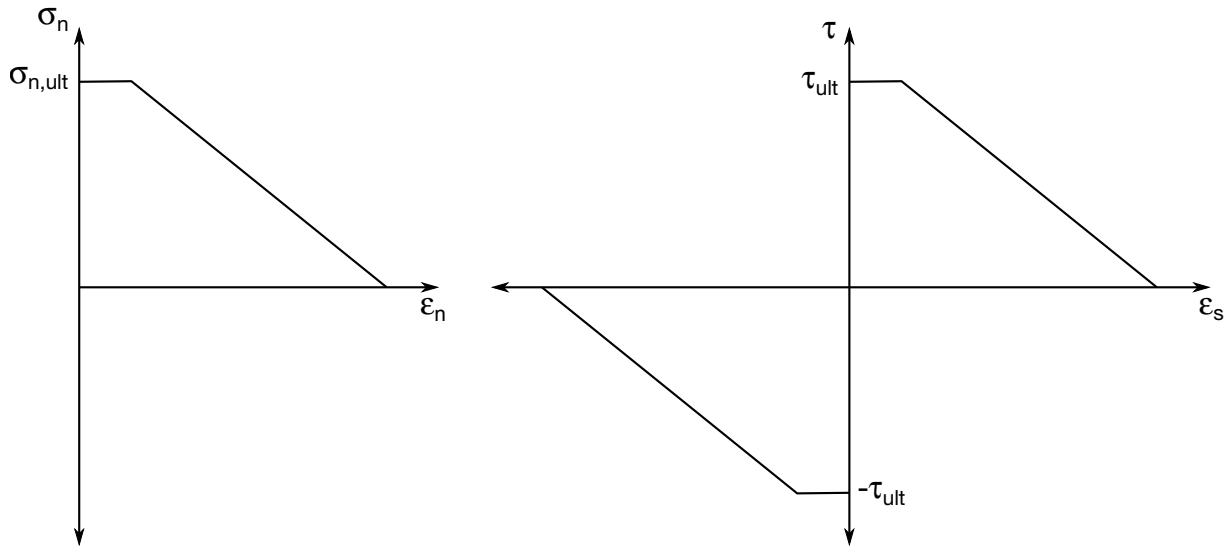

Figure M132-1. Shows stress bounds for the active normal component (left) and the archive shear component (right).

*MAT_BARLAT_YLD2000

This is Material Type 133. This model was developed by Barlat et al. [2003] to overcome some shortcomings of the six parameter Barlat model implemented as material 33 (MAT_BARLAT_YLD96) in LS-DYNA. This model is available for shell, thick shell, and solid elements. Support for solid elements started with R12 but only for explicit analysis. The model for solid elements is based on the approach by Dunand et al. [2012].

Card Summary:

Card 1. This card is required.

MID	RO	E	PR	FIT	BETA	ITER	ISCALE
-----	----	---	----	-----	------	------	--------

Card 2. This card is required.

K	E0	N	C	P	HARD	A	
---	----	---	---	---	------	---	--

Card 2.1. This card is included if A < 0.

CRC1	CRA1	CRC2	CRA2	CRC3	CRA3	CRC4	CRA4
------	------	------	------	------	------	------	------

Card 3a. This card is included if FIT = 0.

ALPHA1	ALPHA2	ALPHA3	ALPHA4	ALPHA5	ALPHA6	ALPHA7	ALPHA8
--------	--------	--------	--------	--------	--------	--------	--------

Card 3b.1. This card is included if FIT = 1.

SIG00	SIG45	SIG90	R00	R45	R90		
-------	-------	-------	-----	-----	-----	--	--

Card 3b.2. This card is included if FIT = 1.

SIGXX	SIGYY	SIGXY	DXX	DYY	DXY		
-------	-------	-------	-----	-----	-----	--	--

Card 4.1. This card is included if HARD = 3.

CP	T0	TREF	TA0				
----	----	------	-----	--	--	--	--

Card 4.2. This card is included if HARD = 3.

A	B	C	D	P	Q	EOMART	VM0
---	---	---	---	---	---	--------	-----

Card 4.3. This card is included if HARD = 3.

AHS	BHS	M	N	EPS0	HMART	K1	K2
-----	-----	---	---	------	-------	----	----

Card 5. This card is required.

AOPT	OFFANG	P4	HTFLAG	HTA	HTB	HTC	HTD
------	--------	----	--------	-----	-----	-----	-----

Card 6. This card is required.

			A1	A2	A3		
--	--	--	----	----	----	--	--

Card 7. This card is required.

V1	V2	V3	D1	D2	D3	USRFAIL	
----	----	----	----	----	----	---------	--

Data Card Definitions:

Card 1	1	2	3	4	5	6	7	8
Variable	MID	RO	E	PR	FIT	BETA	ITER	ISCALE
Type	A	F	F	F	F	F	F	F

VARIABLE

DESCRIPTION

MID	Material identification. A unique number or label must be specified (see *PART).
RO	Mass density
E	Young's modulus LE.0: -E is either a load curve ID for Young's modulus as a function of plastic strain or a table ID for Young's modulus as a function of plastic strain and temperature.
PR	Poisson's ratio LE.0: -PR is a load curve ID for Poisson's ratio as a function of temperature.
FIT	Material parameter fit flag: EQ.0.0: Material parameters are used directly on Card 3a. EQ.1.0: Material parameters are determined from test data on Cards 3b.1 and 3b.2.

VARIABLE	DESCRIPTION
BETA	Hardening parameter. Any value ranging from 0 (isotropic hardening) to 1 (kinematic hardening) may be input. This field is ignored if the flow potential exponent A is input as a negative number.
ITER	Plastic iteration flag: EQ.0.0: Plane stress algorithm for stress return EQ.1.0: Secant iteration algorithm for stress return ITER provides an option of using three secant iterations for determining the thickness strain increment as experiments have shown that this leads to a more accurate prediction of shell thickness changes for rapid processes. A significant increase in computation time is incurred with this option so it should be used only for applications associated with high rates of loading and/or for implicit analysis.
ISCALE	Yield locus scaling flag: EQ.0.0: Scaling on - reference direction is the rolling direction (default) EQ.1.0: Scaling off – reference direction arbitrary

Card 2	1	2	3	4	5	6	7	8
Variable	K	E0	N	C	P	HARD	A	
Type	F	F	F	F	F	F	F	

VARIABLE	DESCRIPTION
K	Material parameter: HARD.EQ.1.0: k , strength coefficient for exponential hardening HARD.EQ.2.0: a in Voce hardening law HARD.EQ.4.0: k , strength coefficient for Gosh hardening HARD.EQ.5.0: a in Hockett-Sherby hardening law
E0	Material parameter: HARD.EQ.1.0: e_0 , strain at yield for exponential hardening

VARIABLE	DESCRIPTION
	HARD.EQ.2.0: b in Voce hardening law HARD.EQ.4.0: ε_0 , strain at yield for Gosh hardening HARD.EQ.5.0: b in Hocket-Sherby hardening law
N	Material parameter: HARD.EQ.1.0: n , exponent for exponential hardening HARD.EQ.2.0: c in Voce hardening law HARD.EQ.4.0: n , exponent for Gosh hardening HARD.EQ.5.0: c in Hocket-Sherby hardening law
C	Cowper-Symonds strain rate parameter, C ; see Remark 1 .
P	Cowper-Symonds strain rate parameter, p ; see Remark 1 .
	$\sigma_y^v(\varepsilon_p, \dot{\varepsilon}_p) = \sigma_y(\varepsilon_p) \left(1 + \left[\frac{\dot{\varepsilon}_p}{C} \right]^{1/p} \right)$
HARD	Hardening law: EQ.1.0: Exponential hardening: $\sigma_y = k(\varepsilon_0 + \varepsilon_p)^n$ EQ.2.0: Voce hardening: $\sigma_y = a - be^{-c\varepsilon_p}$ EQ.3.0: Hansel hardening (see Remark 4) EQ.4.0: Gosh hardening: $\sigma_y = k(\varepsilon_0 + \varepsilon_p)^n - p$ EQ.5.0: Hocket-Sherby hardening: $\sigma_y = a - be^{-c\varepsilon_p^q}$ LT.0.0: Absolute value defines load curve ID, table ID or 3D table ID. If it is a load curve, then yield stress is a function of plastic strain. If it is a table, then yield stress is a function of either plastic strain and plastic strain rate in case of a 2D table, or, a function of plastic strain, plastic strain rate, and temperature in case of a 3D table.
A	Flow potential exponent. For face centered cubic (FCC) materials $A = 8$ is recommended and for body centered cubic (BCC) materials $A = 6$ may be used. If the input is negative, then an extra card for Chaboche-Roussilier kinematic hardening is read, the flow potential exponent is taken as the absolute value of what is input, and BETA above is ignored.

Chaboche-Rousselier Card. Additional Card for $A < 0$.

Card 2.1	1	2	3	4	5	6	7	8
Variable	CRC1	CRA1	CRC2	CRA2	CRC3	CRA3	CRC4	CRA4
Type	F	F	F	F	F	F	F	F

VARIABLE**DESCRIPTION**

CRC_n Chaboche-Rousselier kinematic hardening parameters; see [Remark 3](#).

CRA_n Chaboche-Rousselier kinematic hardening parameters; see [Remark 3](#).

Direct Material Parameter Card. Additional card for $FIT = 0$.

Card 3a	1	2	3	4	5	6	7	8
Variable	ALPHA1	ALPHA2	ALPHA3	ALPHA4	ALPHA5	ALPHA6	ALPHA7	ALPHA8
Type	F	F	F	F	F	F	F	F

VARIABLE**DESCRIPTION**

$ALPHA_i$ α_i , see [Remark 2](#). If ALPHA1 is input as a negative number, then the absolute value is the ID of a load curve giving α_1 as a function of temperature. With this choice, *all* ALPHA $_i$ must be negative and given by curves.

Test Data Card 1. Additional card for $FIT = 1$.

Card 3b.1	1	2	3	4	5	6	7	8
Variable	SIG00	SIG45	SIG90	R00	R45	R90		
Type	F	F	F	F	F	F		

Test Data Card 2. Additional Card for FIT = 1.

Card 3b.2	1	2	3	4	5	6	7	8
Variable	SIGXX	SIGYY	SIGXY	DXX	DYY	DXY		
Type	F	F	F	F	F	F		

VARIABLE**DESCRIPTION**

SIG00	Yield stress in 00 direction LT.0.0: -SIG00 is load curve ID, defining this stress as a function of temperature.
SIG45	Yield stress in 45 direction LT.0.0: -SIG45 is load curve ID, defining this stress as a function of temperature.
SIG90	Yield stress in 90 direction LT.0.0: -SIG90 is load curve ID, defining this stress as a function of temperature.
R00	R-value in 00 direction LT.0.0: -R00 is load curve ID, defining this value as a function of temperature.
R45	R-value in 45 direction LT.0.0: -R45 is load curve ID, defining this value as a function of temperature.
R90	R-value in 90 direction LT.0.0: -R90 is load curve ID, defining this value as a function of temperature.
SIGXX	<i>xx</i> -component of stress on yield surface (see Remark 2).
SIGYY	<i>yy</i> -component of stress on yield surface (see Remark 2).
SIGXY	<i>xy</i> -component of stress on yield surface (see Remark 2).
DXX	<i>xx</i> -component of tangent to yield surface (see Remark 2).

VARIABLE	DESCRIPTION
DYY	yy -component of tangent to yield surface (see Remark 2).
DXY	xy -component of tangent to yield surface (see Remark 2).

Hansel Hardening Card 1. Additional card for HARD = 3.

Card 4.1	1	2	3	4	5	6	7	8
Variable	CP	T0	TREF	TA0				
Type	F	F	F	F				

VARIABLE	DESCRIPTION
CP	Adiabatic temperature calculation option: EQ.0.0: Adiabatic temperature calculation is disabled. GT.0.0: CP is the specific heat C_p . Adiabatic temperature calculation is enabled.
T0	Initial temperature T_0 of the material if adiabatic temperature calculation is enabled
TREF	Reference temperature for output of the yield stress as history variable
TA0	Reference temperature T_{A0} , the absolute zero for the used temperature scale, such as -273.15 if the Celsius scale is used and 0.0 if the Kelvin scale is used.

Hansel Hardening Card 2. Additional card for HARD = 3.

Card 4.2	1	2	3	4	5	6	7	8
Variable	A	B	C	D	P	Q	EOMART	VM0
Type	F	F	F	F	F	F	F	F

VARIABLE	DESCRIPTION
A	Martensite rate equation parameter A , see Remark 4 .

VARIABLE	DESCRIPTION
B	Martensite rate equation parameter B , see Remark 4 .
C	Martensite rate equation parameter C , see Remark 4 .
D	Martensite rate equation parameter D , see Remark 4 .
P	Martensite rate equation parameter p , see Remark 4 .
Q	Martensite rate equation parameter Q , see Remark 4 .
E0MART	Martensite rate equation parameter $E_{0(\text{mart})}$, see Remark 4 .
VM0	<p>The initial volume fraction of martensite $0.0 < V_{m0} < 1.0$ may be initialized using two different methods:</p> <p>GT.0.0: V_{m0} is set to VM0.</p> <p>LT.0.0: Can be used only when there are initial plastic strains ϵ^p present, such as when using *INITIAL_STRESS_SHELL. The absolute value of VM0 is then the load curve ID for a function, f, that sets $V_{m0} = f(\epsilon^p)$. The function f must be a monotonically nondecreasing function of ϵ^p.</p>

Hansel Hardening Card 3. Additional card for HARD = 3.

Card 4.3	1	2	3	4	5	6	7	8
Variable	AHS	BHS	M	N	EPS0	HMART	K1	K2
Type	F	F	F	F	F	F	F	F

VARIABLE	DESCRIPTION
AHS	Hardening law parameter A_{HS} , see Remark 4 .
BHS	Hardening law parameter B_{HS} , see Remark 4 .
M	Hardening law parameter m , see Remark 4 .
N	Hardening law parameter n , see Remark 4 .
EPS0	Hardening law parameter ϵ_0 , see Remark 4 .
HMART	Hardening law parameter $\Delta H_{\gamma \rightarrow \alpha'}$, see Remark 4 .

VARIABLE	DESCRIPTION
K1	Hardening law parameter K_1 , see Remark 4 .
K2	Hardening law parameter K_2 , see Remark 4 .

Card 5	1	2	3	4	5	6	7	8
Variable	AOPT	OFFANG	P4	HTFLAG	HTA	HTB	HTC	HTD
Type	F	F	F	F	F	F	F	F

VARIABLE	DESCRIPTION
AOPT	<p>Material axes option (see *MAT_OPTIONTROPIC_ELASTIC for more details):</p> <p>EQ.0.0: Locally orthotropic with material axes determined by element nodes as shown in Figure M133-1. Nodes 1, 2, and 4 of an element are identical to the nodes used for the definition of a coordinate system as by *DEFINE_COORDINATE_NODES.</p> <p>EQ.2.0: Globally orthotropic with material axes determined by vectors defined below, as with *DEFINE_COORDINATE_VECTOR</p> <p>EQ.3.0: Locally orthotropic material axes determined by offsetting the material axes by an angle, OFFANG, from a line determined by taking the cross product of the vector v with the normal to the plane of the element.</p> <p>LT.0.0: the absolute value of AOPT is a coordinate system ID number (CID on *DEFINE_COORDINATE_NODES, *DEFINE_COORDINATE_SYSTEM or *DEFINE_COORDINATE_VECTOR).</p>
OFFANG	Offset angle for AOPT = 3
P4	<p>Material parameter:</p> <p>HARD.EQ.4.0: p in Gosh hardening law</p> <p>HARD.EQ.5.0: q in Hocket-Sherby hardening law</p>

VARIABLE	DESCRIPTION
HTFLAG	Heat treatment flag (see Remark 5): EQ.0: Preforming stage EQ.1: Heat treatment stage EQ.2: Postforming stage
HTA	Load curve or table ID for postforming parameter <i>a</i>
HTB	Load curve or table ID for postforming parameter <i>b</i>
HTC	Load curve or table ID for postforming parameter <i>c</i>
HTD	Load curve or table ID for postforming parameter <i>d</i>

Card 6	1	2	3	4	5	6	7	8
Variable				A1	A2	A3		
Type				F	F	F		

VARIABLE	DESCRIPTION
A1, A2, A3	Components of vector a for AOPT = 2

Card 7	1	2	3	4	5	6	7	8
Variable	V1	V2	V3	D1	D2	D3	USRFAIL	
Type	F	F	F	F	F	F	F	

VARIABLE	DESCRIPTION
V1, V2, V3	Components of vector v for AOPT = 3
D1, D2, D3	Components of vector d for AOPT = 2
USRFAIL	User defined failure flag: EQ.0: No user subroutine is called. EQ.1: User subroutine <code>matusr_24</code> in <code>dyn21.f</code> is called.

Remarks:

1. **Cowper - Symonds Strain Rate.** Strain rate is accounted for using the Cowper and Symonds model which scales the yield stress with the factor

$$1 + \left(\frac{\dot{\varepsilon}_p}{C} \right)^{1/p},$$

where $\dot{\varepsilon}_p$ is the plastic strain rate. To ignore strain rate effects set both C and P to zero.

2. **Yield Condition.** The yield condition for this material can be written as

$$f(\boldsymbol{\sigma}, \boldsymbol{\alpha}, \varepsilon_p) = \sigma_{\text{eff}}(\sigma_{xx} - 2\alpha_{xx} - \alpha_{yy}, \sigma_{yy} - 2\alpha_{yy} - \alpha_{xx}, \sigma_{xy} - \alpha_{xy}) - \sigma_Y^t(\varepsilon_p, \dot{\varepsilon}_p, \beta) \leq 0$$

where

$$\begin{aligned} \sigma_{\text{eff}}(s_{xx}, s_{yy}, s_{xy}) &= \left[\frac{1}{2} (\varphi' + \varphi'') \right]^{1/a} \\ \varphi' &= |X'_1 - X'_2|^a \\ \varphi'' &= |2X''_1 + X''_2|^a + |X''_1 + 2X''_2|^a \end{aligned}$$

The X'_i and X''_i are eigenvalues of X'_{ij} and X''_{ij} and are given by

$$\begin{aligned} X'_1 &= \frac{1}{2} \left(X'_{11} + X'_{22} + \sqrt{(X'_{11} - X'_{22})^2 + 4X'_{12}{}^2} \right) \\ X'_2 &= \frac{1}{2} \left(X'_{11} + X'_{22} - \sqrt{(X'_{11} - X'_{22})^2 + 4X'_{12}{}^2} \right) \end{aligned}$$

and

$$\begin{aligned} X''_1 &= \frac{1}{2} \left(X''_{11} + X''_{22} + \sqrt{(X''_{11} - X''_{22})^2 + 4X''_{12}{}^2} \right) \\ X''_2 &= \frac{1}{2} \left(X''_{11} + X''_{22} - \sqrt{(X''_{11} - X''_{22})^2 + 4X''_{12}{}^2} \right) \end{aligned}$$

respectively. The X'_{ij} and X''_{ij} are given by

$$\begin{aligned} \begin{pmatrix} X'_{11} \\ X'_{22} \\ X'_{12} \end{pmatrix} &= \begin{pmatrix} L'_{11} & L'_{12} & 0 \\ L'_{21} & L'_{22} & 0 \\ 0 & 0 & L'_{33} \end{pmatrix} \begin{pmatrix} s_{xx} \\ s_{yy} \\ s_{xy} \end{pmatrix} \\ \begin{pmatrix} X''_{11} \\ X''_{22} \\ X''_{12} \end{pmatrix} &= \begin{pmatrix} L''_{11} & L''_{12} & 0 \\ L''_{21} & L''_{22} & 0 \\ 0 & 0 & L''_{33} \end{pmatrix} \begin{pmatrix} s_{xx} \\ s_{yy} \\ s_{xy} \end{pmatrix} \end{aligned}$$

where,

$$\begin{pmatrix} L'_{11} \\ L'_{12} \\ L'_{21} \\ L'_{22} \\ L'_{33} \end{pmatrix} = \frac{1}{3} \begin{pmatrix} 2 & 0 & 0 \\ -1 & 0 & 0 \\ 0 & -1 & 0 \\ 0 & 2 & 0 \\ 0 & 0 & 3 \end{pmatrix} \begin{pmatrix} \alpha_1 \\ \alpha_2 \\ \alpha_7 \end{pmatrix}$$

$$\begin{pmatrix} L''_{11} \\ L''_{12} \\ L''_{21} \\ L''_{22} \\ L''_{33} \end{pmatrix} = \frac{1}{9} \begin{pmatrix} -2 & 2 & 8 & -2 & 0 \\ 1 & -4 & -4 & 4 & 0 \\ 4 & -4 & -4 & 1 & 0 \\ -2 & 8 & 2 & -2 & 0 \\ 0 & 0 & 0 & 0 & 9 \end{pmatrix} \begin{pmatrix} \alpha_3 \\ \alpha_4 \\ \alpha_5 \\ \alpha_6 \\ \alpha_8 \end{pmatrix}$$

The parameters α_1 to α_8 are the parameters that determines the shape of the yield surface. s_{xx} , s_{yy} , and s_{xy} do not denote the deviatoric stress components but the arguments are used in the σ_{eff} function.

The material parameters can be determined from three uniaxial tests and a more general test. From the uniaxial tests the yield stress and R-values are used and from the general test an arbitrary point on the yield surface is used given by the stress components in the material system as

$$\sigma = \begin{pmatrix} \sigma_{xx} \\ \sigma_{yy} \\ \sigma_{xy} \end{pmatrix}$$

together with a tangent of the yield surface in that particular point. For the latter the tangential direction should be determined so that

$$d_{xx}\dot{\epsilon}_{xx}^p + d_{yy}\dot{\epsilon}_{yy}^p + 2d_{xy}\dot{\epsilon}_{xy}^p = 0 .$$

The biaxial data can be set to zero in the input deck for LS-DYNA to just fit the uniaxial data.

The effective stress (excluding back stress) can be output to the d3plot database through *DEFINE_MATERIAL_HISTORIES.

<i>*DEFINE_MATERIAL_HISTORIES Properties</i>		
Label	Attributes	Description
Effective Stress	- - - -	Effective stress $\sigma_{\text{eff}}(\sigma_{xx}, \sigma_{yy}, \sigma_{xy})$, see above

- Kinematic Hardening Model.** A kinematic hardening model is implemented following the works of Chaboche and Roussilier. A back stress, α , is introduced such that the effective stress is computed as

$$\sigma_{\text{eff}} = \sigma_{\text{eff}}(\sigma_{11} - 2\alpha_{11} - \alpha_{22}, \sigma_{22} - 2\alpha_{22} - \alpha_{11}, \sigma_{12} - \alpha_{12}) .$$

The back stress is the sum of up to four terms according to

$$\alpha_{ij} = \sum_{k=1}^4 \alpha_{ij}^k ,$$

and the evolution of each back stress component is as follows

$$\delta \alpha_{ij}^k = C_k \left(a_k \frac{s_{ij} - \alpha_{ij}}{\sigma_{\text{eff}}} - \alpha_{ij}^k \right) \delta \varepsilon_p ,$$

where C_k and a_k are material parameters, s_{ij} is the deviatoric stress tensor, σ_{eff} is the effective stress and ε_p is the effective plastic strain. The yield condition for this case is modified according to

$$f(\boldsymbol{\sigma}, \boldsymbol{\alpha}, \varepsilon_p) = \sigma_{\text{eff}} (\sigma_{xx} - 2\alpha_{xx} - \alpha_{yy}, \sigma_{yy} - 2\alpha_{yy} - \alpha_{xx}, \sigma_{xy} - \alpha_{xy}) \\ - \left\{ \sigma_Y^t(\varepsilon_p, \dot{\varepsilon}_p, 0) - \sum_{k=1}^4 a_k [1 - \exp(-C_k \varepsilon_p)] \right\} \leq 0$$

in order to get the expected stress strain response for uniaxial stress.

4. **Hansel Hardening Law.** The Hansel hardening law is the same as in material 113 but is repeated here for the sake of convenience.

The hardening is temperature dependent and therefore this material model must be run either in a coupled thermo-mechanical solution, using prescribed temperatures or using the adiabatic temperature calculation option. Setting the parameter CP to the specific heat C_p of the material activates the adiabatic temperature calculation that calculates the temperature rate from the equation

$$\dot{T} = \sum_{i,j} \frac{\sigma_{ij} D_{ij}^P}{\rho C_p} ,$$

where $\boldsymbol{\sigma} : \mathbf{D}^P$ (the numerator) is the plastically dissipated heat. Using the Kelvin scale is recommended, even though other scales may be used without problems.

The hardening behaviour is described by the following equations. The martensite rate equation is

$$\frac{\partial V_m}{\partial \bar{\varepsilon}^p} = \begin{cases} 0 & \varepsilon < E_{0(\text{mart})} \\ \frac{B}{A} V_m^p \left(\frac{1 - V_m}{V_m} \right)^{\frac{B+1}{B}} \frac{[1 - \tanh(C + D \times T)]}{2} \exp\left(\frac{Q}{T - T_{A0}}\right) & \bar{\varepsilon}^p \geq E_{0(\text{mart})} \end{cases}$$

where $\bar{\varepsilon}^p$ is the effective plastic strain and T is the temperature. The martensite fraction is integrated from the above rate equation:

$$V_m = \int_0^{\varepsilon} \frac{\partial V_m}{\partial \bar{\varepsilon}^p} d\bar{\varepsilon}^p .$$

It always holds that $0.0 < V_m < 1.0$. The initial martensite content is V_{m0} and must be greater than zero and less than 1.0. Note that V_{m0} is not used during a restart or when initializing the V_m history variable using *INITIAL_STRESS_SHELL.

The yield stress σ_y is

$$\sigma_y = \{B_{HS} - (B_{HS} - A_{HS})\exp(-m[\bar{\epsilon}^p + \epsilon_0]^n)\}(K_1 + K_2T) + \Delta H_{\gamma \rightarrow \alpha'} V_m.$$

The parameters P and B should fulfill the following condition

$$\frac{1 + B}{B} < p .$$

If not fulfilled, the martensite rate will approach infinity as V_m approaches zero. A value between 0.001 and 0.02 is recommended for ϵ_0 .

Apart from the effective true strain a few additional history variables are output as described in the table below.

History Variable #	Description
26	Yield stress of material at temperature TREF. This variable is useful when evaluating the strength of the material after, for example, a simulated forming operation.
27	Volume fraction martensite, V_m
28	If CP = 0.0, it is not used. If CP > 0.0, then it is the temperature from the adiabatic temperature calculation.

- Heat Treatment.** Heat treatment for increasing the formability of prestrained aluminum sheets can be simulated through the use of HTFLAG, where the intention is to run a forming simulation in steps involving preforming, springback, heat treatment, and postforming. In each step the history is transferred to the next using a dynain file (see *INTERFACE_SPRINGBACK). The first two steps are performed with HTFLAG = 0 according to standard procedures, resulting in a plastic strain field ϵ_p^0 corresponding to the prestrain. The heat treatment step is performed using HTFLAG = 1 in a coupled thermomechanical simulation, where the blank is heated. The coupling between thermal and mechanical processes is only through the maximum temperature T^0 being stored as a history variable in the material model, corresponding to the heat treatment temperature. Here it is important to export all history variables to the dynain file for the

postforming step. In the final postforming step, HTFLAG = 2, the yield stress is then augmented by the Hockett-Sherby like term

$$\Delta\sigma = b - (b - a)\exp\left[-c(\varepsilon_p - \varepsilon_p^0)^d\right],$$

where a , b , c , and d are given as tables as functions of the heat treatment temperature T^0 and prestrain ε_p^0 . That is, in the table definitions each load curve corresponds to a given prestrain and the load curve value is with respect to the heat treatment temperature,

$$a = a(T^0, \varepsilon_p^0) , \quad b = b(T^0, \varepsilon_p^0) , \quad c = c(T^0, \varepsilon_p^0) , \quad d = d(T^0, \varepsilon_p^0)$$

The effect of heat treatment is that the material strength decreases but hardening increases, thus typically,

$$a \leq 0 , \quad b \geq a , \quad c > 0 , \quad d > 0 .$$

***MAT_VISCOELASTIC_FABRIC**

This is Material Type 134. The viscoelastic fabric model is a variation on the general viscoelastic model of material 76. This model is valid for 3 and 4 node membrane elements only and is strongly recommended for modeling isotropic viscoelastic fabrics where wrinkling may be a problem. For thin fabrics, buckling can result in an inability to support compressive stresses; thus, a flag is included for this option. If bending stresses are important use a shell formulation with model 76.

Card Summary:

Card 1. This card is required.

MID	RO	BULK				CSE	
-----	----	------	--	--	--	-----	--

Card 2. If fitting is done from a relaxation curve, specify fitting parameters on this card, otherwise if constants are set on Card 3, LEAVE THIS CARD BLANK.

LCID	NT	BSTART	TRAMP	LCIDK	NTK	BSTARTK	TRAMPK
------	----	--------	-------	-------	-----	---------	--------

Card 3. This card is not needed if Card 2 is defined (not blank). Up to 6 of this card may be input. If fewer than 6 cards are used, then the next keyword ("*") card terminates this input.

GI	BETAI	KI	BETAKI				
----	-------	----	--------	--	--	--	--

Data Card Definitions:

Card 1	1	2	3	4	5	6	7	8
Variable	MID	RO	BULK				CSE	
Type	I	F	F				F	

VARIABLE**DESCRIPTION**

MID	Material identification. A unique number must be specified.
RO	Mass density.
BULK	Elastic constant bulk modulus. If the bulk behavior is viscoelastic, then this modulus is used in determining the contact interface stiffness only.

VARIABLE	DESCRIPTION
CSE	Compressive stress flag (default = 0.0): EQ.0.0: Don't eliminate compressive stresses. EQ.1.0: Eliminate compressive stresses.

Relaxation Curve Card. If fitting is done from a relaxation curve, specify fitting parameters on card 2, *otherwise* if constants are set on Viscoelastic Constant Cards *LEAVE THIS CARD BLANK*.

Card 2	1	2	3	4	5	6	7	8
Variable	LCID	NT	BSTART	TRAMP	LCIDK	NTK	BSTARTK	TRAMPK
Type	F	I	F	F	F	I	F	F

VARIABLE	DESCRIPTION
LCID	Load curve ID if constants, G_i , and β_i are determined using a least squares fit. See Figure M134-1 .
NT	Number of terms in shear fit. If zero, the default is 6. Currently, the maximum number is set to 6.
BSTART	In the fit, β_1 is set to zero, β_2 is set to BSTART, β_3 is 10 times β_2 , β_4 is 10 times β_3 , and so on. If zero, BSTART = 0.01.
TRAMP	Optional ramp time for loading.
LCIDK	Load curve ID for bulk behavior if constants, K_i and β_{κ_i} are determined using a least squares fit. See Figure M134-1 .
NTK	Number of terms desired in bulk fit. If zero, the default is 6. Currently, the maximum number is set to 6.
BSTARTK	In the fit, β_{κ_1} is set to zero, β_{κ_2} is set to BSTARTK, β_{κ_3} is 10 times β_{κ_2} , β_{κ_4} is 10 times β_{κ_3} , and so on. If zero, BSTARTK = 0.01.
TRAMPK	Optional ramp time for bulk loading

Viscoelastic Constant Cards. Up to 6 cards may be input. A keyword (“*”) card terminates this input if fewer than 6 cards are used. These cards are not needed if relaxation data is defined. The number of terms for the shear behavior may differ from that for the bulk behavior: simply insert zero if a term is not included.

Card 3	1	2	3	4	5	6	7	8
Variable	G_i	BETA <i>i</i>	K_i	BETA <i>Ki</i>				
Type	F	F	F	F				

VARIABLE

DESCRIPTION

GI	Optional shear relaxation modulus for the i^{th} term
BETA <i>I</i>	Optional shear decay constant for the i^{th} term
KI	Optional bulk relaxation modulus for the i^{th} term
BETA <i>KI</i>	Optional bulk decay constant for the i^{th} term

Remarks:

Rate effects are taken into account through linear viscoelasticity through a convolution integral of the form:

$$\sigma_{ij} = \int_0^t g_{ijkl}(t - \tau) \frac{\partial \epsilon_{kl}}{\partial \tau} d\tau ,$$

where $g_{ijkl}(t - \tau)$ is the relaxation function. If we wish to include only simple rate effects for the deviatoric stresses, the relaxation function is represented by six terms from the Prony series:

$$g(t) = \sum_{m=1}^N G_m e^{-\beta_m t} .$$

We characterize this function by the input shear moduli, G_i , and decay constants, β_i . An arbitrary number of terms, up to 6, may be used when applying the viscoelastic model.

For volumetric relaxation, the relaxation function is also represented by the Prony series in terms of bulk moduli:

$$k(t) = \sum_{m=1}^N K_m e^{-\beta_{\kappa_m} t} .$$

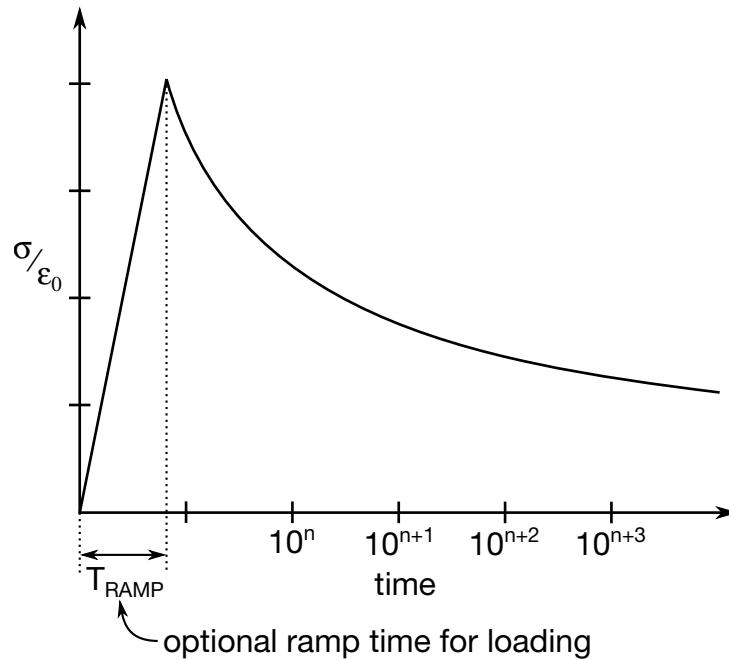

Figure M134-1. Stress Relaxation Curve

For an example of a stress relaxation curve see [Figure M134-1](#). This curve defines stress as a function of time where time is defined on a logarithmic scale. For best results, the points defined in the load curve should be equally spaced on the logarithmic scale. Furthermore, the load curve should be smooth and defined in the positive quadrant. If non-physical values are determined by least squares fit, LS-DYNA will terminate with an error message after the initialization phase is completed. If the ramp time for loading is included, then the relaxation which occurs during the loading phase is taken into account. This effect may or may not be important.

***MAT_WTM_STM**

This is Material Type 135. This anisotropic-viscoplastic material model adopts two yield criteria for metals with orthotropic anisotropy proposed by Barlat and Lian [1989] (Weak Texture Model) and Aretz [2004] (Strong Texture Model).

Card Summary:

Card 1. This card is required.

MID	RO	E	PR	NUMFI	EPSC	WC	TAUC
-----	----	---	----	-------	------	----	------

Card 2. This card is required.

SIGMA0	QR1	CR1	QR2	CR2	K	LC	FLG
--------	-----	-----	-----	-----	---	----	-----

Card 3a. This card is included if and only if FLG = 0.

A1	A2	A3	A4	A5	A6	A7	A8
----	----	----	----	----	----	----	----

Card 3b. This card is included if and only if FLG = 1.

S00	S45	S90	SBB	R00	R45	R90	RBB
-----	-----	-----	-----	-----	-----	-----	-----

Card 3c. This card is included if and only if FLG = 2.

A	C	H	P				
---	---	---	---	--	--	--	--

Card 4. This card is required.

QX1	CX1	QX2	CX2	EDOT	M	EMIN	S100
-----	-----	-----	-----	------	---	------	------

Card 5. This card is required.

AOPT	BETA						
------	------	--	--	--	--	--	--

Card 6. This card is required.

			A1	A2	A3		
--	--	--	----	----	----	--	--

Card 7. This card is required.

V1	V2	V3	D1	D2	D3		
----	----	----	----	----	----	--	--

Data Card Definitions:

Card 1	1	2	3	4	5	6	7	8
Variable	MID	RO	E	PR	NUMFI	EPSC	WC	TAUC
Type	A	F	F	F	F	F	F	F

VARIABLE**DESCRIPTION**

MID	Material identification. A unique number or label must be specified (see *PART).
RO	Mass density
E	Young's modulus
PR	Poisson's ratio
NUMFI	Number of through thickness integration points that must fail before the element is deleted (remember to change this number if switching between full and reduced integration type of elements).
EPSC	Critical value ε_{tC} of the plastic thickness strain (used in the CTS fracture criterion).
WC	Critical value W_c for the Cockcroft-Latham fracture criterion
TAUC	Critical value τ_c for the Bressan-Williams shear fracture criterion

Card 2	1	2	3	4	5	6	7	8
Variable	SIGMA0	QR1	CR1	QR2	CR2	K	LC	FLG
Type	F	F	F	F	F	F	F	F

VARIABLE**DESCRIPTION**

SIGMA0	Initial mean value of yield stress σ_0 : GT.0.0: Constant value
--------	---

VARIABLE	DESCRIPTION
	LT.0.0: Load curve ID = -SIGMA0 which defines yield stress as a function of plastic strain. Hardening parameters QR1, CR1, QR2, and CR2 are ignored in that case.
QR1	Isotropic hardening parameter Q_{R1}
CR1	Isotropic hardening parameter C_{R1}
QR2	Isotropic hardening parameter Q_{R2}
CR2	Isotropic hardening parameter C_{R2}
K	k , equals half YLD2003 exponent m . Recommended value for FCC materials is $m = 8$, that is, $k = 4$.
LC	Load curve ID giving the relation between the pre-strain and the yield stress σ_0 . Similar curves for Q_{R1} , C_{R1} , Q_{R2} , C_{R2} , and W_c must follow consecutively from this number.
FLG	Flag to determine the card for defining yield: EQ.0: Use Card 3a for YLD2003. EQ.1: Use Card 3b for yield surface. EQ.2: Use Card 3c for YLD89.

YLD2003 Card. This card 3 format is used when FLG = 0.

Card 3a	1	2	3	4	5	6	7	8
Variable	A1	A2	A3	A4	A5	A6	A7	A8
Type	F	F	F	F	F	F	F	F

VARIABLE	DESCRIPTION
A1	YLD2003 parameter a_1
A2	YLD2003 parameter a_2
A3	YLD2003 parameter a_3
A4	YLD2003 parameter a_4

VARIABLE	DESCRIPTION
A5	YLD2003 parameter a_5
A6	YLD2003 parameter a_6
A7	YLD2003 parameter a_7
A8	YLD2003 parameter a_8

Yield Surface Card. This card 3 format is used when FLG = 1.

Card 3b	1	2	3	4	5	6	7	8
Variable	S00	S45	S90	SBB	R00	R45	R90	RBB
Type	F	F	F	F	F	F	F	F

VARIABLE	DESCRIPTION
S00	Yield stress in 0° direction
S45	Yield stress in 45° direction
S90	Yield stress in 90° direction
SBB	Balanced biaxial flow stress
R00	R-ratio in 0° direction
R45	R-ratio in 45° direction
R90	R-ratio in 90° direction
RBB	Balance biaxial flow ratio

YLD89 Card. This card 3 format used when FLG = 2.

Card 3c	1	2	3	4	5	6	7	8
Variable	A	C	H	P				
Type	F	F	F	F				

VARIABLE	DESCRIPTION
A	YLD89 parameter a
C	YLD89 parameter c
H	YLD89 parameter h
P	YLD89 parameter p

Card 4	1	2	3	4	5	6	7	8
Variable	QX1	CX1	QX2	CX2	EDOT	M	EMIN	S100
Type	F	F	F	F	F	F	F	F

VARIABLE	DESCRIPTION
QX1	Kinematic hardening parameter Q_{x1}
CX1	Kinematic hardening parameter C_{x1}
QX2	Kinematic hardening parameter Q_{x2}
CX2	Kinematic hardening parameter C_{x2}
EDOT	Strain rate parameter $\dot{\epsilon}_0$
M	Strain rate parameter m
EMIN	Lower limit of the isotropic hardening rate $\frac{dR}{d\bar{\epsilon}}$. This feature is included to model a non-zero and linear/exponential isotropic work hardening rate at large values of effective plastic strain. If the isotropic work hardening rate predicted by the utilized Voce-type work hardening rule falls below the specified value it is substituted by the prescribed value or switched to a power-law hardening if $S100 \neq 0$. This option should be considered for problems involving extensive plastic deformations. If process dependent material characteristics are prescribed, that is, if $LC > 0$ the same minimum tangent modulus is assumed for all the prescribed work hardening curves. If instead $EMIN < 0$ then $-EMIN$ defines the plastic strain value at which the linear or power-law hardening approximation commences.

VARIABLE	DESCRIPTION
----------	-------------

S100	Yield stress at 100% strain for using a power-law approximation beyond the strain defined by EMIN.
------	--

Card 5	1	2	3	4	5	6	7	8
Variable	AOPT	BETA						
Type	F	F						

VARIABLE	DESCRIPTION
----------	-------------

AOPT	Material axes option (see MAT_OPTIONTROPIC_ELASTIC for a more complete description):
------	--

EQ.0.0: Locally orthotropic with material axes determined by element nodes 1, 2, and 4, as with *DEFINE_COORDINATE_NODES, and then rotated about the shell element normal by an angle BETA

EQ.2.0: Globally orthotropic with material axes determined by vectors defined below, as with *DEFINE_COORDINATE_VECTOR

EQ.3.0: Locally orthotropic material axes determined by rotating the material axes about the element normal by an angle, BETA, from a line in the plane of the element defined by the cross product of the vector v with the element normal

LT.0.0: The absolute value of AOPT is a coordinate system ID number (CID on *DEFINE_COORDINATE_NODES, *DEFINE_COORDINATE_SYSTEM or *DEFINE_COORDINATE_VECTOR). Available in R3 version of 971 and later.

BETA	Material angle in degrees for AOPT = 0 or 3. It may be overwritten on the element card; see *ELEMENT_SHELL_BETA.
------	--

Card 6	1	2	3	4	5	6	7	8
Variable				A1	A2	A3		
Type				F	F	F		

VARIABLE

DESCRIPTION

A1 A2 A3

Components of vector **a** for AOPT = 2

Card 7	1	2	3	4	5	6	7	8
Variable	V1	V2	V3	D1	D2	D3		
Type	F	F	F	F	F	F		

VARIABLE

DESCRIPTION

V1 V2 V3

Components of vector **v** for AOPT = 3

D1 D2 D3

Components of vector **d** for AOPT = 2

Remarks:

- Material Model.** The yield condition for this material can be written

$$t(\boldsymbol{\sigma}, \boldsymbol{\alpha}, \varepsilon^p, \dot{\varepsilon}^p) = \sigma_{\text{eff}}(\boldsymbol{\sigma}, \boldsymbol{\alpha}) - \sigma_Y(\varepsilon^p, \dot{\varepsilon}^p) .$$

The yield stress is defined as

$$\sigma_Y = [\sigma_0 + R(\varepsilon^p)] \left(1 + \frac{\dot{\varepsilon}^p}{\dot{\varepsilon}_0} \right)^C ,$$

where the isotropic hardening reads

$$R(\dot{\varepsilon}^p) = Q_{R1}[1 - \exp(-C_{R1}\varepsilon^p)] + Q_{R2}[1 - \exp(-C_{R2}\dot{\varepsilon}^p)] .$$

For the Weak Texture Model the yield function is defined as

$$\sigma_{\text{eff}} = \left[\frac{1}{2} \{ a(k_1 + k_2)^m + a(k_1 - k_2)^m + C(2k_2)^m \} \right]^{1/m}$$

where

$$k_1 = \frac{\sigma_x + h\sigma_y}{2}$$

$$k_2 = \sqrt{\left(\frac{\sigma_x + h\sigma_y}{2}\right)^2 + (r\sigma_{xy})^2}$$

For the Strong Texture Model the yield function is defined as

$$\sigma_{\text{eff}} = \left\{ \frac{1}{2} [(\sigma'_+)^m + (\sigma'_-)^m + (\sigma''_+ - \sigma''_-)^m] \right\}^{\frac{1}{m}},$$

where

$$\sigma'_\pm = \frac{a_8\sigma_x + a_1\sigma_y}{2} \pm \sqrt{\left(\frac{a_2\sigma_x - a_3\sigma_y}{2}\right)^2 + a_4^2\sigma_{xy}^2}$$

$$\sigma''_\pm = \frac{\sigma_x + \sigma_y}{2} \pm \sqrt{\left(\frac{a_5\sigma_x - a_6\sigma_y}{2}\right)^2 + a_7^2\sigma_{xy}}$$

Kinematic hardening can be included by

$$\alpha = \sum_{R=1}^2 \alpha_R,$$

where each of the kinematic hardening variables α_R is independent and obeys a nonlinear evolutionary equation in the form

$$\dot{\alpha}_R = C_{\alpha i} \left(Q_{\alpha i} \frac{\tau}{\sigma} - \alpha_R \right) \dot{\epsilon}^p.$$

The effective stress $\bar{\sigma}$ is defined as

$$\bar{\sigma} = \sigma_{\text{eff}}(\tau),$$

where

$$\tau = \sigma - \alpha.$$

Critical thickness strain failure in a layer is assumed to occur when

$$\epsilon_t \leq \epsilon_{tc},$$

where ϵ_{tc} is a material parameter. It should be noted that ϵ_{tc} is a negative number (meaning failure is assumed to occur only in the case of thinning).

Cockcraft and Latham fracture is assumed to occur when

$$W = \int \max(\sigma_1, 0) d\epsilon^p \geq W_C,$$

where σ_1 is the maximum principal stress and W_C is a material parameter.

2. **Yield Surface Parameters.** If FLG = 1, that is, if the yield surface parameters a_1 through a_8 are identified on the basis of prescribed material data internally in the material routine, files with point data for plotting of the identified yield surface, along with the predicted directional variation of the yield stress and plastic

flow are generated in the directory where the LS-DYNA analysis is run. Four different files are generated for each specified material.

These files are named according to the scheme:

- a) Contour_1#
- b) Contour_2#
- c) Contour_3#
- d) R_and_S#

where # is a value starting at 1.

The first three files contain contour data for plotting of the yield surface as shown in [Figure M135-2](#). To generate these plots a suitable plotting program should be adopted and for each file/plot, column A should be plotted as a function of column B. [Figure M135-3](#) further shows a plot generated from the final file named R_and_S# showing the directional dependency of the normalized yield stress (column A vs. B) and plastic strain ratio (column B vs. C).

3. **History Variables.** The following additional history variables can be included in the output d3plot file.

History Variable #	Description
1	Isotropic hardening value R_1
2	Isotropic hardening value R_2
3	Increment in effective plastic strain $\Delta\bar{\epsilon}$
4	Not defined, for internal use in the material model
5	Not defined, for internal use in the material model
6	Not defined, for internal use in the material model
7	Failure in integration point EQ.0: No failure EQ.1: Failure due to EPSC, i.e. $\epsilon_t \geq \epsilon_{tc}$. EQ.2: Failure due to WC, i.e. $W \geq W_c$. EQ.3: Failure due to TAUC, i.e. $\tau \geq \tau_c$
8	Sum of incremental strain in local element x -direction: $\epsilon_{xx} = \sum \Delta\epsilon_{xx}$

History Variable #	Description
9	Sum of incremental strain in local element y -direction: $\varepsilon_{yy} = \sum \Delta\varepsilon_{yy}$
10	Value of the Cockcroft-Latham failure parameter $W = \sum \sigma_1 \Delta p$
11	Plastic strain component in thickness direction ε_t
12	Mean value of increments in plastic strain through the thickness. (For use with the non-local instability criterion. Note that constant lamella thickness is assumed, and the instability criterion can give unrealistic results if used with a user-defined integration rule with varying lamella thickness.)
13	Not defined, for internal use in the material model
14	Nonlocal value $\rho = \frac{\Delta\varepsilon_3}{\Delta\varepsilon_3^\Omega}$

Table M135-1.

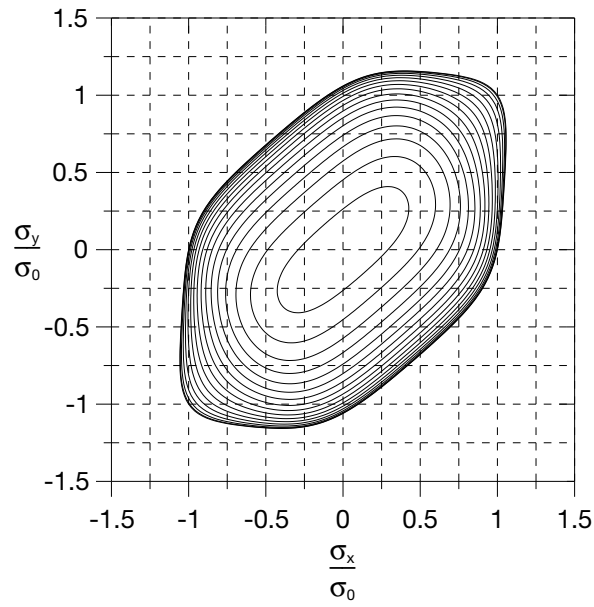

(A)

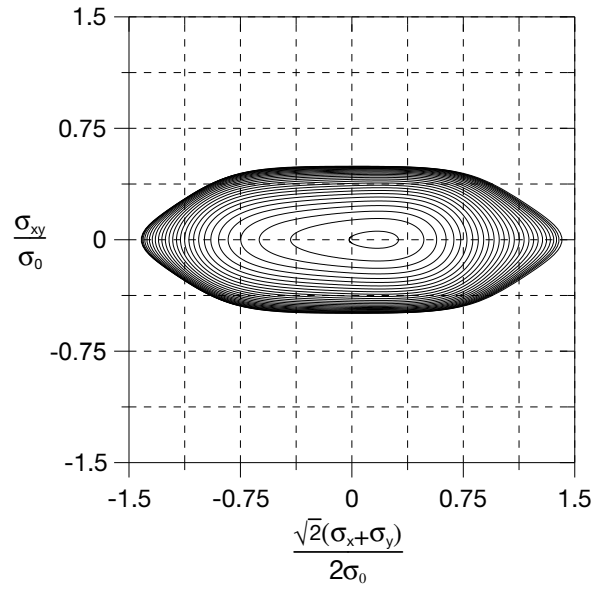

(B)

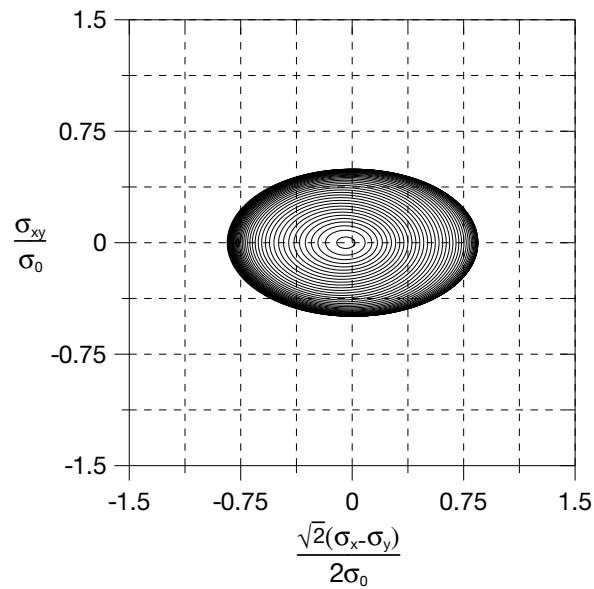

(C)

Figure M135-2. Contour plots of the yield surface generated from the files (a) 'Contour_1<#>', (b) Contour_2<#>, and (c) Contour_3<#>.

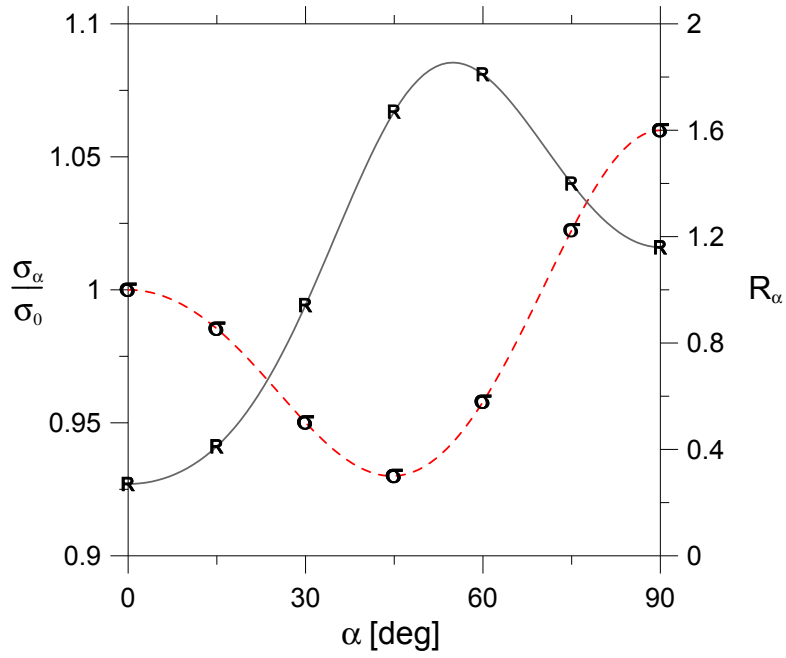

Figure M135-3. Predicted directional variation of the yield stress and plastic flow generated from the file R_and_S<#>.

***MAT_WTM_STM_PLC**

This is Material Type 135. This anisotropic material adopts the yield criteria proposed by Aretz [2004]. The material strength is defined by McCormick's constitutive relation for materials exhibiting negative steady-state Strain Rate Sensitivity (SRS). McCormick [1998] and Zhang, McCormick and Estrin [2001].

Card 1	1	2	3	4	5	6	7	8
Variable	MID	RO	E	PR	NUMFI	EPSC	WC	TAUC
Type	A	F	F	F	F	F	F	F

Card 2	1	2	3	4	5	6	7	8
Variable	SIGMA0	QR1	CR1	QR2	CR2	K		
Type	F	F	F	F	F	F		

Card 3	1	2	3	4	5	6	7	8
Variable	A1	A2	A3	A4	A5	A6	A7	A8
Type	F	F	F	F	F	F	F	F

Card 4	1	2	3	4	5	6	7	8
Variable	S	H	OMEGA	TD	ALPHA	EPS0		
Type	F	F	F	F	F	F		

Card 5	1	2	3	4	5	6	7	8
Variable	AOPT	BETA						
Type	F	F						

Card 6	1	2	3	4	5	6	7	8
Variable				A1	A2	A3		
Type				F	F	F		

Card 7	1	2	3	4	5	6	7	8
Variable	V1	V2	V3	D1	D2	D3		
Type	F	F	F	F	F	F		

VARIABLE**DESCRIPTION**

MID	Material identification. A unique number or label must be specified (see *PART).
RO	Mass density
E	Young's modulus
PR	Poisson's ratio
NUMFI	Number of through thickness integration points that must fail before the element is deleted (remember to change this number if switching between full and reduced integration type of elements)
EPSC	Critical value, ϵ_{tC} , of the plastic thickness strain
WC	Critical value, W_c , for the Cockcroft-Latham fracture criterion.
TAUC	Critical value, τ_c , for the shear fracture criterion.
SIGMA0	Initial yield stress, σ_0
QR1	Isotropic hardening parameter, Q_{R1}
CR1	Isotropic hardening parameter, C_{R1}
QR2	Isotropic hardening parameter, Q_{R2}
CR2	Isotropic hardening parameter, C_{R2}

VARIABLE	DESCRIPTION
K	k equals half the exponent m for the yield criterion
A1	Yld2003 parameter, a_1
A2	Yld2003 parameter, a_2
A3	Yld2003 parameter, a_3
A4	Yld2003 parameter, a_4
A5	Yld2003 parameter, a_5
A6	Yld2003 parameter, a_6
A7	Yld2003 parameter, a_7
A8	Yld2003 parameter, a_8
S	Dynamic strain aging parameter, S
H	Dynamic strain aging parameter, H
OMEGA	Dynamic strain aging parameter, Ω
TD	Dynamic strain aging parameter, t_d
ALPHA	Dynamic strain aging parameter, α
EPS0	Dynamic strain aging parameter, $\dot{\epsilon}_0$
AOPT	Material axes option (see *MAT_OPTIONTROPIC_ELASTIC for a more complete description): EQ.0.0: Locally orthotropic with material axes determined by element nodes as shown in Figure M2-1 , and then rotated about the shell element normal by the angle BETA. Nodes 1, 2 and 4 of an element are identical to the nodes used for the definition of a coordinate system as by *DEFINE_COORDINATE_NODES. EQ.2.0: Globally orthotropic with material axes determined by vectors defined below, as with *DEFINE_COORDINATE_VECTOR.

VARIABLE	DESCRIPTION
	EQ.3.0: Locally orthotropic material axes determined by offsetting the material axes by an angle, BETA, from a line determined by taking the cross product of the vector \mathbf{v} with the normal to the plane of the element.
	LT.0.0: The absolute value of AOPT is a coordinate system ID number (CID on *DEFINE_COORDINATE_NODES, *DEFINE_COORDINATE_SYSTEM or *DEFINE_COORDINATE_VECTOR).
BETA	Material angle in degrees for AOPT = 0 and 3. BETA may be overwritten on the element card; see *ELEMENT_SHELL_BETA.
A1, A2, A3	Components of vector \mathbf{a} for AOPT = 2
V1, V2, V3	Components of vector \mathbf{v} for AOPT = 3
D1, D2, D3	Components of vector \mathbf{d} for AOPT = 2

Remarks:

The yield function is defined as

$$f = \sigma_{\text{eq}}(\boldsymbol{\sigma}) - [\sigma_Y(t_a) + R(\varepsilon_p) + \sigma_v(\dot{\varepsilon}^p)] ,$$

where the equivalent stress σ_{eq} is defined as by an anisotropic yield criterion

$$\sigma_{\text{eq}} = \left[\frac{1}{2} (|\sigma'_1|^m + |\sigma'_2|^m + |\sigma''_1 - \sigma''_2|) \right]^{\frac{1}{m}} .$$

Here

$$\left\{ \begin{array}{l} \sigma'_1 \\ \sigma'_2 \end{array} \right\} = \frac{a_8 \sigma_{xx} + a_1 \sigma_{yy}}{2} \pm \sqrt{\left(\frac{a_2 \sigma_{xx} - a_3 \sigma_{yy}}{2} \right)^2 + a_4^2 \sigma_{xy}^2}$$

and

$$\left\{ \begin{array}{l} \sigma''_1 \\ \sigma''_2 \end{array} \right\} = \frac{\sigma_{xx} + \sigma_{yy}}{2} \pm \sqrt{\left(\frac{a_5 \sigma_{xx} - a_6 \sigma_{yy}}{2} \right)^2 + a_7^2 \sigma_{xy}^2} .$$

The strain hardening function, R , is defined by the extended Voce law

$$R(\varepsilon^p) = \sum_{i=1}^2 Q_{Ri} (1 - \exp(-C_{Ri} \varepsilon^p)) ,$$

where ε^p is the effective (or accumulated) plastic strain, and Q_{Ri} and C_{Ri} are strain hardening parameters.

Viscous stress, σ_v , is given by

$$\sigma_v = (\dot{\epsilon}^p) = s \ln \left(1 + \frac{\dot{\epsilon}^p}{\dot{\epsilon}_0} \right) ,$$

where s represents the instantaneous strain rate sensitivity (SRS) and $\dot{\epsilon}_0$ is a reference strain rate. In this model the yield strength, including the contribution from dynamic strain aging (DSA) is defined as

$$\sigma_Y(t_a) = \sigma_0 + SH \left[1 - \exp \left\{ - \left(\frac{t_a}{t_d} \right)^\alpha \right\} \right]$$

where σ_0 is the yield strength for vanishing average waiting time, t_a (meaning at high strain rates). H , α , and t_d are material constants linked to dynamic strain aging. It is noteworthy that σ_Y is an increasing function of t_a . The average waiting time is defined by the evolution equation

$$\dot{t}_a = 1 - \frac{t_a}{t_{a,ss}} ,$$

where the quasi-steady waiting time $t_{a,ss}$ is given as

$$t_{a,ss} = \frac{\Omega}{\dot{\epsilon}^p} .$$

Here Ω is the strain produced by all mobile dislocations moving to the next obstacle on their path.

*MAT_VEGTER

This is Material Type 136 (formerly named *MAT_CORUS_VEGTER), a plane stress orthotropic material model for metal forming. Yield surface construction is based on the interpolation by second-order Bezier curves, and model parameters are determined directly from a set of mechanical tests conducted for several directions. For each direction, four mechanical tests are carried out: a uniaxial, an equi-biaxial, a plane strain tensile test and a shear test. These test results are used to determine the coefficients of the Fourier directional dependency field. For a more detailed description please see Vegter and Boogaard [2006].

Card Summary:

Card 1. This card is required.

MID	RO	E	PR	N	FBI	RBIO	LCID
-----	----	---	----	---	-----	------	------

Card 2. This card is required.

SYS	SIP	SHS	SHL	ESH	E0	ALPHA	LCID2
-----	-----	-----	-----	-----	----	-------	-------

Card 3. This card is required.

AOPT							
------	--	--	--	--	--	--	--

Card 4. This card is required.

XP	YP	ZP	A1	A2	A3		
----	----	----	----	----	----	--	--

Card 5. This card is required.

V1	V2	V3	D1	D2	D3	BETA	
----	----	----	----	----	----	------	--

Card 6. Include N+1 of this card.

FUN- <i>i</i>	RUN- <i>i</i>	FPS1- <i>i</i>	FPS2- <i>i</i>	FSH- <i>i</i>			
---------------	---------------	----------------	----------------	---------------	--	--	--

Data Card Definitions:

Card 1	1	2	3	4	5	6	7	8
Variable	MID	RO	E	PR	N	FBI	RBIO	LCID
Type	A	F	F	F	F	F	F	F

VARIABLE

DESCRIPTION

MID	Material identification. A unique number or label must be specified (see *PART).
RO	Material density
E	Elastic Young's modulus
PR	Poisson's ratio
N	<p> N is the order of the Fourier series (meaning number of test groups minus one). The minimum number for N is 2, and the maximum is 10.</p> <p>GE.0.0: Explicit cutting-plane return mapping algorithm</p> <p>LT.0.0: Fully implicit return mapping algorithm (more robust)</p>
FBI	Normalized yield stress σ_{bi} for equi-biaxial test
RBIO	Strain ratio $\sigma_{bi}(0^\circ) = \dot{\epsilon}_2(0^\circ) / \dot{\epsilon}_1(0^\circ)$ for equi-biaxial test in the rolling direction
LCID	<p>Load curve ID or Table ID. If defined, SYS, SIP, SHS, SHL, ESH, and E0 are ignored.</p> <p>Load Curve. When LCID is a load curve ID, it is taken as defining effective stress as a function of effective plastic strain.</p> <p>Tabular Data. The table ID defines for each strain rate value a load curve ID giving the stress as a function effective plastic strain for that strain rate. Linear interpolation between the discrete strain rates is used by default.</p>

VARIABLE**DESCRIPTION**

Logarithmically Defined Tables. A way to invoke logarithmic interpolation between discrete strain rates is described as follows. If the *first* value in the table is negative, LS-DYNA assumes that all the table values represent the natural logarithm of a strain rate. There is some additional computational cost associated with invoking logarithmic interpolation.

Card 2	1	2	3	4	5	6	7	8
Variable	SYS	SIP	SHS	SHL	ESH	E0	ALPHA	LCID2
Type	F	F	F	F	F	F	F	F

VARIABLE**DESCRIPTION**

SYS	Static yield stress, σ_0
SIP	Stress increment parameter, $\Delta\sigma_m$
SHS	Strain hardening parameter for small strain, β
SHL	Strain hardening parameter for larger strain, Ω
ESH	Exponent for strain hardening, n
E0	Initial plastic strain, ε_0
ALPHA	Distribution of hardening used in the curve-fitting, α . $\alpha = 0$ is pure kinematic hardening while $\alpha = 1$ provides pure isotropic hardening.
LCID2	Curve ID. The curve defines Young's modulus scaling factor with respect to the plastic strain. By default, the Young's modulus is assumed to remain constant. Effective value is between 0 and 1.

Card 3	1	2	3	4	5	6	7	8
Variable	AOPT							
Type	F							

VARIABLE**DESCRIPTION**

AOPT

Material axes option (see `MAT_OPTIONTROPIC_ELASTIC` for a more complete description):

EQ.0.0: Locally orthotropic with material axes determined by element nodes 1, 2, and 4, as with `*DEFINE_COORDINATE_NODES` and then rotated about the shell element normal by the angle BETA

EQ.2.0: Globally orthotropic with material axes determined by vectors defined below, as with `*DEFINE_COORDINATE_VECTOR`

EQ.3.0: Locally orthotropic material axes determined by rotating the material axes about the element normal by an angle, BETA, from a line in the plane of the element defined by the cross product of the vector \mathbf{v} with the element normal

LT.0.0: The absolute value of AOPT is a coordinate system ID number (CID on `*DEFINE_COORDINATE_NODES`, `*DEFINE_COORDINATE_SYSTEM` or `*DEFINE_COORDINATE_VECTOR`).

Card 4	1	2	3	4	5	6	7	8
Variable	XP	YP	ZP	A1	A2	A3		
Type	F	F	F	F	F	F		

VARIABLE**DESCRIPTION**

XP, YP, ZP

Coordinates of point p for AOPT = 1

A1, A2, A3

Components of vector \mathbf{a} for AOPT = 2

Card 5	1	2	3	4	5	6	7	8
Variable	V1	V2	V3	D1	D2	D3	BETA	
Type	F	F	F	F	F	F	F	

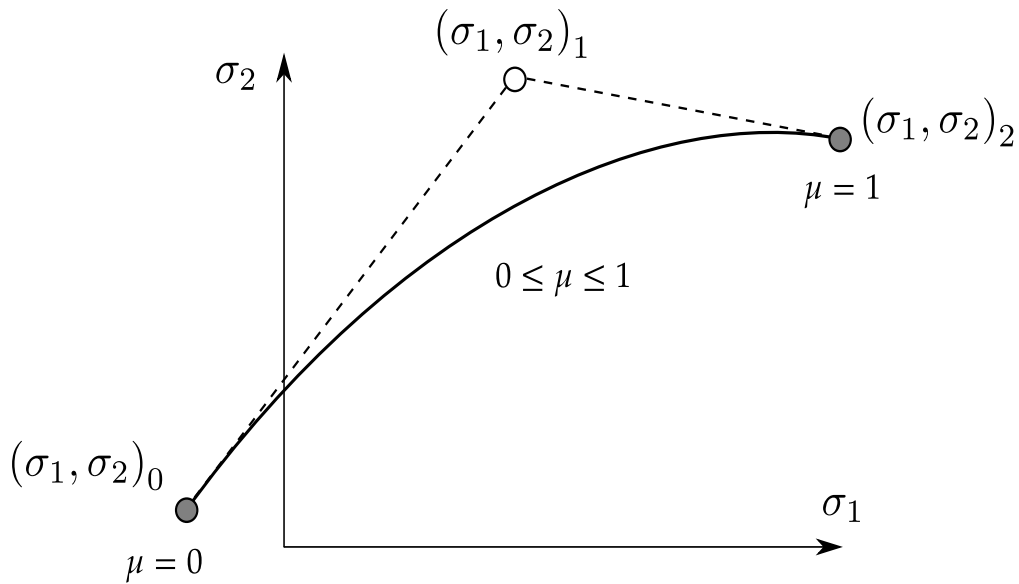

Figure M136-1. Bézier interpolation curve.

VARIABLE	DESCRIPTION
V1, V2, V3	Components of vector v for AOPT = 3
D1, D2, D3	Components of vector d for AOPT = 2
BETA	Material angle in degrees for AOPT = 0 and 3. BETA may be overwritten on the element card; see *ELEMENT_SHELL_BETA.

Experimental Data Cards. The next N+1 cards (see N on Card 1) contain experimental data obtained from four mechanical tests for a group of equidistantly placed directions $\theta_i = \frac{i\pi}{2N}, i = 0, 1, 2, \dots, N$.

Card 6	1	2	3	4	5	6	7	8
Variable	FUN- <i>i</i>	RUN- <i>i</i>	FPS1- <i>i</i>	FPS2- <i>i</i>	FSH- <i>i</i>			
Type	F	F	F	F	F			

VARIABLE	DESCRIPTION
FUN- <i>i</i>	Normalized yield stress σ_{un} for uniaxial test for the <i>i</i> th direction
RUN- <i>i</i>	Strain ratio (R-value) for uniaxial test for the <i>i</i> th direction
FPS1- <i>i</i>	First normalized yield stress σ_{ps1} for plain strain test for the <i>i</i> th direction

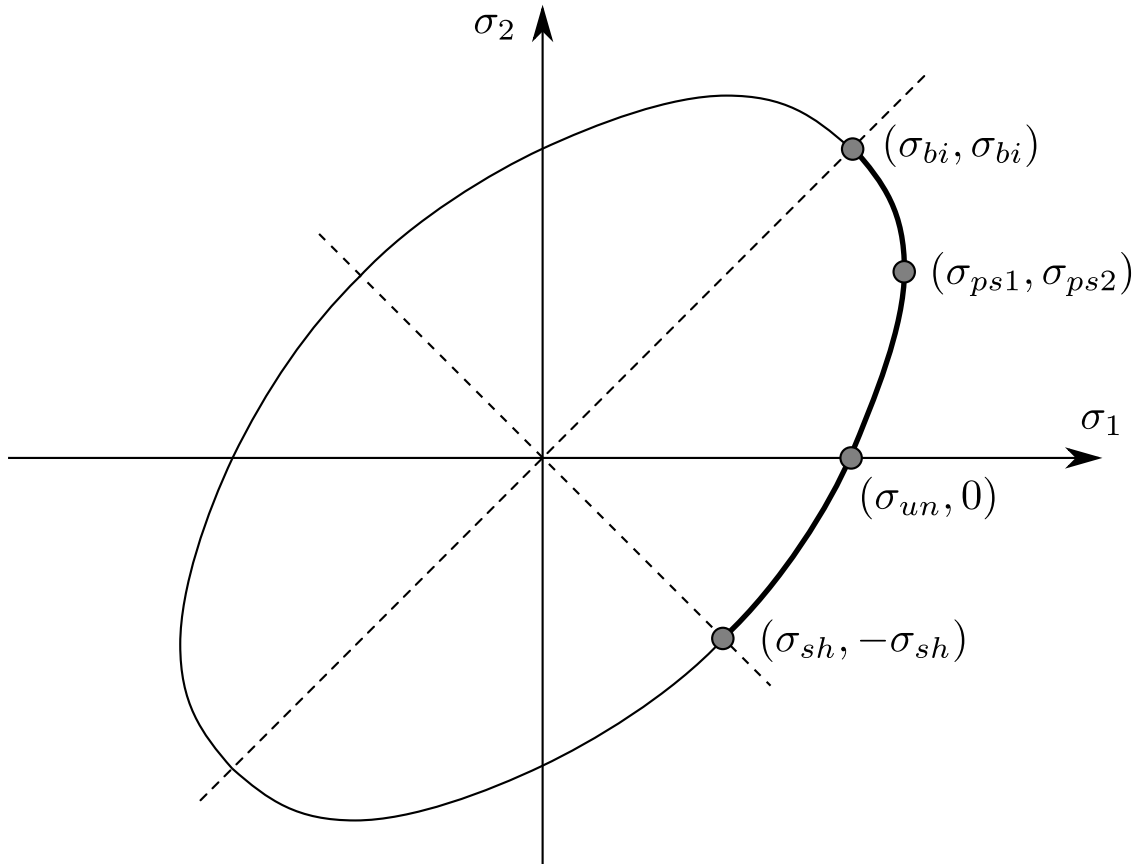

Figure M136-2. Vegter yield surface.

VARIABLE	DESCRIPTION
FPS2- <i>i</i>	Second normalized yield stress σ_{ps2} for plain strain test for the i^{th} direction
FSH- <i>i</i>	First normalized yield stress σ_{sh} for pure shear test for the i^{th} direction

Remarks:

The Vegter yield locus is section-wise defined by quadratic Bézier interpolation functions. Each individual curve uses 2 reference points and a hinge point in the principal plane stress space; see [Figure M136-1](#).

The mathematical description of the Bézier interpolation is given by:

$$\begin{pmatrix} \sigma_1 \\ \sigma_2 \end{pmatrix} = \begin{pmatrix} \sigma_1 \\ \sigma_2 \end{pmatrix}_0 + 2\mu \left[\begin{pmatrix} \sigma_1 \\ \sigma_2 \end{pmatrix}_1 - \begin{pmatrix} \sigma_1 \\ \sigma_2 \end{pmatrix}_0 \right] + \mu^2 \left[\begin{pmatrix} \sigma_1 \\ \sigma_2 \end{pmatrix}_2 + \begin{pmatrix} \sigma_1 \\ \sigma_2 \end{pmatrix}_0 - 2 \begin{pmatrix} \sigma_1 \\ \sigma_2 \end{pmatrix}_1 \right],$$

where $(\sigma_1, \sigma_2)_0$ is the first reference point, $(\sigma_1, \sigma_2)_1$ is the hinge point, and $(\sigma_1, \sigma_2)_2$ is the second reference point. μ is a parameter which determines the location on the curve ($0 \leq \mu \leq 1$).

Four characteristic stress states are selected as reference points: the equi-biaxial point $(\sigma_{bi}, \sigma_{bi})$, the plane strain point $(\sigma_{ps1}, \sigma_{ps2})$, the uniaxial point $(\sigma_{un}, 0)$ and the pure shear point $(\sigma_{sh}, -\sigma_{sh})$; see [Figure M136-2](#). Between the 4 stress points, 3 Bézier curves are used to interpolate the yield locus. Symmetry conditions are used to construct the complete surface. The yield locus in [Figure M136-2](#) shows the reference points of experiments for one specific direction. The reference points can also be determined for other angles to the rolling direction (planar angle θ). For example, if $N = 2$ is chosen, normalized yield stresses for directions 0° , 45° , and 90° should be defined. A Fourier series is used to interpolate intermediate angles between the measured points.

The Vegter yield function with isotropic hardening (ALPHA = 1) is given as:

$$\phi = \sigma_{eq}(\sigma_1, \sigma_2, \theta) - \sigma_y(\bar{\epsilon}^p)$$

with the equivalent stress σ_{eq} obtained from the appropriate Bézier function related to the current stress state. The uniaxial yield stress σ_y can be defined as stress-strain curve LCID or alternatively as a functional expression:

$$\sigma_y = \sigma_0 + \Delta\sigma_m \left[\beta(\bar{\epsilon}^p + \epsilon_0) + \left(1 - e^{-\Omega(\bar{\epsilon}^p + \epsilon_0)}\right)^n \right]$$

In case of kinematic hardening (ALPHA < 1), the standard stress tensor is replaced by a relative stress tensor, defined as the difference between the stress tensor and a back stress tensor.

To determine the yield stress or reference points of the Vegter yield locus, four mechanical tests have to be performed for different directions. A good description about the material characterization procedure can be found in Vegter et al. (2003).

***MAT_VEGTER_STANDARD**

This is Material Type 136_STD, a plane stress orthotropic material model for metal forming. Yield surface construction is based on the interpolation by second-order Bezier curves, and model parameters are determined directly from a set of mechanical tests conducted for a number of directions. For each direction, four mechanical tests are carried out: a uniaxial, an equi-biaxial, a plane strain tensile test and a shear test. The material formulation is equivalent to MAT_VEGTER, except it requires different parameters for the plane strain tensile test and can use the Bergström-Van Liempt equation to deal with strain rate effects. These test results are used to determine the coefficients of the Fourier directional dependency field. For a more detailed description please see Vegter and Boogaard [2006].

Card Summary:

Card 1. This card is required.

MID	RO	E	PR	N	FBI	RBIO	LCID
-----	----	---	----	---	-----	------	------

Card 2. This card is required.

SYS	SIP	SHS	SHL	ESH	E0	ALPHA	LCID2
-----	-----	-----	-----	-----	----	-------	-------

Card 3. This card is required.

AOPT		DYS	RATEN	SRNO	EXSR		
------	--	-----	-------	------	------	--	--

Card 4. This card is required.

XP	YP	ZP	A1	A2	A3		
----	----	----	----	----	----	--	--

Card 5. This card is required.

V1	V2	V3	D1	D2	D3	BETA	
----	----	----	----	----	----	------	--

Card 6. Include N+1 of this card.

FUN- <i>i</i>	RUN- <i>i</i>	FPS1- <i>i</i>	ALPS- <i>i</i>	FSH- <i>i</i>			
---------------	---------------	----------------	----------------	---------------	--	--	--

Data Card Definitions:

Card 1	1	2	3	4	5	6	7	8
Variable	MID	RO	E	PR	N	FBI	RBIO	LCID
Type	A	F	F	F	F	F	F	F

VARIABLE**DESCRIPTION**

MID	Material identification. A unique number or label must be specified (see*PART).
RO	Material density
E	Elastic Young's modulus
PR	Poisson's ratio
N	Order of the Fourier series (meaning number of test groups minus one). The minimum number for N is 2, and the maximum is 10.
FBI	Normalized yield stress σ_{bi} for equi-biaxial test
RBIO	Strain ratio $\sigma_{bi}(0^\circ) = \dot{\epsilon}_2(0^\circ)/\dot{\epsilon}_1(0^\circ)$ for equi-biaxial test in the rolling direction
LCID	<p>Load curve ID or table ID. If defined, SYS, SIP, SHS, SHL, ESH, E0, DYS, RATEN, SRN0, and EXSR are ignored.</p> <p>Load Curve. When LCID is a load curve ID, it is taken as defining effective stress as a function of effective plastic strain.</p> <p>Tabular Data. The table ID defines for each strain rate value a load curve ID giving the stress as a function effective plastic strain for that strain rate. Linear interpolation between the discrete strain rates is used by default.</p> <p>Logarithmically Defined Tables. A way to invoke logarithmic interpolation between discrete strain rates is described as follows. If the <i>first</i> value in the table is negative, LS-DYNA assumes that all the table values represent the natural logarithm of a strain rate. There is some additional computational cost associated with invoking logarithmic interpolation.</p>

Card 2	1	2	3	4	5	6	7	8
Variable	SYS	SIP	SHS	SHL	ESH	E0	ALPHA	LCID2
Type	F	F	F	F	F	F	F	F

VARIABLE**DESCRIPTION**

SYS	Static yield stress, σ_0
SIP	Stress increment parameter, $\Delta\sigma_m$
SHS	Strain hardening parameter for small strain, β
SHL	Strain hardening parameter for larger strain, Ω
ESH	Exponent for strain hardening, n
E0	Initial plastic strain, ε_0
ALPHA	Distribution of hardening used in the curve-fitting, α . $\alpha = 0$ is pure kinematic hardening while $\alpha = 1$ provides pure isotropic hardening.
LCID2	Curve ID. The curve defines Young's modulus scaling factor with respect to the plastic strain. By default, the Young's modulus is assumed to remain constant. Effective value is between 0 and 1.

Card 3	1	2	3	4	5	6	7	8
Variable	AOPT		DYS	RATEN	SRNO	EXSR		
Type	F		F	F	F	F		

VARIABLE**DESCRIPTION**

AOPT	Material axes option (see MAT_OPTIONTROPIC_ELASTIC for a more complete description): EQ.0.0: Locally orthotropic with material axes determined by element nodes 1, 2, and 4, as with *DEFINE_COORDINATE_NODES and then rotated about the shell element normal by the angle BETA
------	--

VARIABLE	DESCRIPTION
	EQ.2.0: Globally orthotropic with material axes determined by vectors defined below, as with *DEFINE_COORDINATE_VECTOR
	EQ.3.0: Locally orthotropic material axes determined by rotating the material axes about the element normal by an angle, BETA, from a line in the plane of the element defined by the cross product of the vector \mathbf{v} with the element normal
	LT.0.0: The absolute value of AOPT is a coordinate system ID number (CID on *DEFINE_COORDINATE_NODES, *DEFINE_COORDINATE_SYSTEM or *DEFINE_COORDINATE_VECTOR).
DYS	Limit dynamic flow stress σ_0^*
RATEN	Ratio r_{enth} of Boltzman constant k (8.617E-5 eV/K) and maximum activation enthalpy ΔG_0 (in eV): $r_{enth} = \frac{k}{\Delta G_0}$
SRN0	Limit strain rate $\dot{\epsilon}_0$
EXSR	Exponent m for strain rate behavior

Card 4	1	2	3	4	5	6	7	8
Variable	XP	YP	ZP	A1	A2	A3		
Type	F	F	F	F	F	F		

VARIABLE	DESCRIPTION
XP, YP, ZP	Coordinates of point p for AOPT = 1
A1, A2, A3	Components of vector \mathbf{a} for AOPT = 2

Card 5	1	2	3	4	5	6	7	8
Variable	V1	V2	V3	D1	D2	D3	BETA	
Type	F	F	F	F	F	F	F	

VARIABLE	DESCRIPTION
V1, V2, V3	Components of vector \mathbf{v} for AOPT = 3
D1, D2, D3	Components of vector \mathbf{d} for AOPT = 2
BETA	Material angle in degrees for AOPT = 0 and 3. BETA may be overwritten on the element card; see *ELEMENT_SHELL_BETA.

Experimental Data Cards. The next N+1 cards (see N on Card 1) contain experimental data obtained from four mechanical tests for a group of equidistantly placed directions $\theta_i = i\pi/(2N), i = 0, 1, 2, \dots, N$.

Card 6	1	2	3	4	5	6	7	8
Variable	FUN- <i>i</i>	RUN- <i>i</i>	FPS1- <i>i</i>	ALPS- <i>i</i>	FSH- <i>i</i>			
Type	F	F	F	F	F			

VARIABLE	DESCRIPTION
FUN- <i>i</i>	Normalized yield stress σ_{un} for uniaxial test for the i^{th} direction
RUN- <i>i</i>	Strain ratio (R-value) for uniaxial test for the i^{th} direction
FPS1- <i>i</i>	First normalized yield stress σ_{ps1} for plain strain test for the i^{th} direction
ALPS- <i>i</i>	Normalized distance α_{ps} of second component of plain stress point between the hinge points on both sides for the i^{th} direction. See Remarks for details.
FSH- <i>i</i>	First normalized yield stress σ_{sh} for pure shear test for the i^{th} direction

Remarks:

1. **Yield Locus.** The yield locus description of this material is the same as for *MAT_VEGTER. The materials share the same Bézier interpolation for the section-wise definition of the yield locus and also use the same four characteristic stress states as reference points. They only differ in the plane-strain point definition in the input. This material MAT_VEGTER_STANDARD does not expect the direct input of the two components $(\sigma_{ps1}, \sigma_{ps2})$, but only of the first component σ_{ps1} . The second component is assumed to be at a fixed distance between

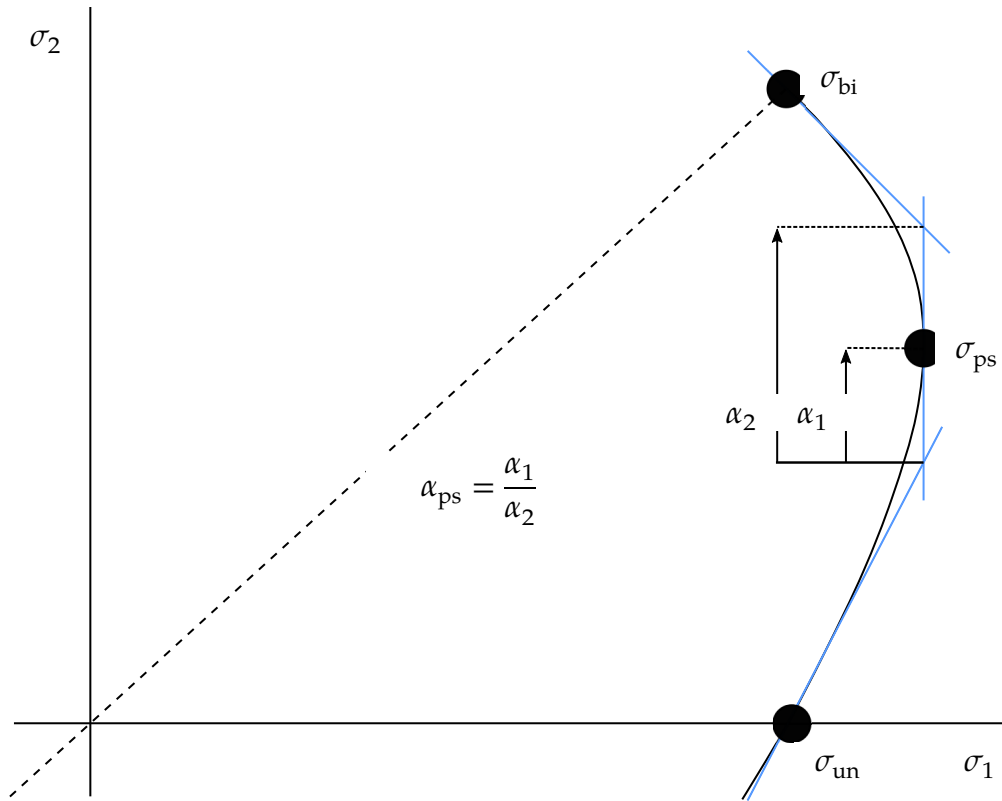

Figure M136-1. Vegter yield surface

the hinge points on both sides. This distance is defined by factor $\alpha_{ps} = \alpha_1/\alpha_2$, as shown in Figure M136-1. This approach is favored in most publications and has for example been discussed in the PhD-thesis of Pijlman, H. H. (2001).

To determine the yield stress or reference points of the Vegter yield locus, four mechanical tests must be performed for different directions. A good description about the material characterization procedure can be found in Vegter et al. (2003).

2. **Strain Hardening.** The Vegter yield function with isotropic hardening (ALPHA = 1) is given as:

$$\phi = \sigma_{eq}(\sigma_1, \sigma_2, \theta) - \sigma_y(\bar{\epsilon}^p, \dot{\bar{\epsilon}}^p, \dot{\epsilon})$$

with the equivalent stress σ_{eq} obtained from the appropriate Bézier function related to the current stress state. The uniaxial yield stress σ_y can be defined as a yield stress curve, $\sigma_y(\bar{\epsilon}^p)$, or a yield stress surface, $\sigma_y(\bar{\epsilon}^p, \dot{\bar{\epsilon}}^p, \dot{\epsilon})$, with LCID. In contrast to *MAT_VEGTER, this material also provides the Bergström-Van Liempt equation as a third alternative:

$$\sigma_y(\bar{\varepsilon}^p, \dot{\bar{\varepsilon}}^p) = \sigma_0 + \Delta\sigma_m \left[\beta(\bar{\varepsilon}^p + \varepsilon_0) + \left(1 - e^{-\Omega(\bar{\varepsilon}^p + \varepsilon_0)}\right)^n \right] + \sigma_0^* \left[1 + r_{\text{enth}} \ln \left(\frac{\dot{\bar{\varepsilon}}^p}{\dot{\bar{\varepsilon}}_0} \right) \right]^m$$

In the case of kinematic hardening (ALPHA < 1), the standard stress tensor is replaced by a relative stress tensor, defined as the difference between the stress tensor and a back stress tensor.

*MAT_VEGTER_2017

This is Material Type 136_2017, a plane stress orthotropic material model for metal forming. It features the advanced Vegter yield locus based on the interpolation by second-order Bezier curves. Model parameters are determined from uniaxial test data at 0°, 45° and 90° to the rolling direction. Therefore, the same mechanical tests must be carried out as for Hill’s 1948 planar anisotropic material model. For a more detailed description of the yield locus, please see Vegter and Boogaard [2006]. The relationships between the results of uniaxial testing and the advanced yield locus are introduced and discussed in Abspoel et al [2017].

Card Summary:

Card 1. This card is required.

MID	RO	E	PR		FBI	RBIO	LCID
-----	----	---	----	--	-----	------	------

Card 2. This card is required.

SYS	SIP	SHS	SHL	ESH	E0	ALPHA	LCID2
-----	-----	-----	-----	-----	----	-------	-------

Card 3. This card is required.

AOPT		DYS	RATEN	SRNO	EXSR		
------	--	-----	-------	------	------	--	--

Card 4. This card is required.

XP	YP	ZP	A1	A2	A3		
----	----	----	----	----	----	--	--

Card 5. This card is required.

V1	V2	V3	D1	D2	D3	BETA	
----	----	----	----	----	----	------	--

Card 6. This card is required.

RM-0	RM-45	RM-90	AG-0	AG-45	AG90		
------	-------	-------	------	-------	------	--	--

Card 7. This card is required.

R00	R45	R90					
-----	-----	-----	--	--	--	--	--

Data Card Definitions:

Card 1	1	2	3	4	5	6	7	8
Variable	MID	RO	E	PR		FBI	RBIO	LCID
Type	A	F	F	F		F	F	F

VARIABLE

DESCRIPTION

MID	Material identification. A unique number or label must be specified (see *PART).
RO	Material density
E	Elastic Young's modulus
PR	Poisson's ratio
FBI	Normalized yield stress σ_{bi} for equi-biaxial test. If this value is not defined in the input, it will be approximated based on the uniaxial test result.
RBIO	Strain ratio $\sigma_{bi}(0^\circ) = \dot{\epsilon}_2(0^\circ)/\dot{\epsilon}_1(0^\circ)$ for equi-biaxial test in the rolling direction. If this value is not defined in the input, it will be approximated based on the uniaxial test result.
LCID	<p>Load curve ID or Table ID. If defined, SYS, SIP, SHS, SHL, ESH, E0, DYS, RATEN, SRN0, and EXSR are ignored.</p> <p>Load Curve. When LCID is a load curve ID, it is taken as defining effective stress as a function of effective plastic strain.</p> <p>Tabular Data. The table ID defines for each strain rate value a load curve ID giving the stress as a function effective plastic strain for that strain rate. Linear interpolation between the discrete strain rates is used by default.</p> <p>Logarithmically Defined Tables. A way to invoke logarithmic interpolation between discrete strain rates is described as follows. If the <i>first</i> value in the table is negative, LS-DYNA assumes that all the table values represent the natural logarithm of a strain rate. There is some additional computational cost associated with invoking logarithmic interpolation.</p>

Card 2	1	2	3	4	5	6	7	8
Variable	SYS	SIP	SHS	SHL	ESH	E0	ALPHA	LCID2
Type	F	F	F	F	F	F	F	F

VARIABLE**DESCRIPTION**

SYS	Static yield stress, σ_0
SIP	Stress increment parameter, $\Delta\sigma_m$
SHS	Strain hardening parameter for small strain, β
SHL	Strain hardening parameter for larger strain, Ω
ESH	Exponent for strain hardening, n
E0	Initial plastic strain, ε_0
ALPHA	Distribution of hardening used in the curve-fitting, α . $\alpha = 0$ is pure kinematic hardening while $\alpha = 1$ provides pure isotropic hardening.
LCID2	Curve ID. The curve defines Young's modulus scaling factor with respect to the plastic strain. By default, the Young's modulus is assumed to remain constant. Effective value is between 0 and 1.

Card 3	1	2	3	4	5	6	7	8
Variable	AOPT		DYS	RATEN	SRNO	EXSR		
Type	F		F	F	F	F		

VARIABLE**DESCRIPTION**

AOPT	Material axes option (see MAT_OPTIONTROPIC_ELASTIC for a more complete description): EQ.0.0: Locally orthotropic with material axes determined by element nodes 1, 2, and 4, as with *DEFINE_COORDINATE_NODES and then rotated about the shell element normal by the angle BETA
------	--

VARIABLE	DESCRIPTION
	EQ.2.0: Globally orthotropic with material axes determined by vectors defined below, as with *DEFINE_COORDINATE_VECTOR
	EQ.3.0: Locally orthotropic material axes determined by rotating the material axes about the element normal by an angle, BETA, from a line in the plane of the element defined by the cross product of the vector v with the element normal
	LT.0.0: The absolute value of AOPT is a coordinate system ID number (CID on *DEFINE_COORDINATE_NODES, *DEFINE_COORDINATE_SYSTEM or *DEFINE_COORDINATE_VECTOR).
DYS	Limit dynamic flow stress, σ_0^*
RATEN	Ratio, r_{enth} , of the Boltzmann constant, k , (8.617E-5 eV/K) and maximum activation enthalpy, ΔG_0 , (in eV): $r_{\text{enth}} = \frac{k}{\Delta G_0}$
SRN0	Limit strain rate, $\dot{\epsilon}_0$
EXSR	Exponent, m , for strain rate behavior

Card 4	1	2	3	4	5	6	7	8
Variable	XP	YP	ZP	A1	A2	A3		
Type	F	F	F	F	F	F		

VARIABLE	DESCRIPTION
XP, YP, ZP	Coordinates of point <i>p</i> for AOPT = 1
A1, A2, A3	Components of vector a for AOPT = 2

Card 5	1	2	3	4	5	6	7	8
Variable	V1	V2	V3	D1	D2	D3	BETA	
Type	F	F	F	F	F	F	F	

VARIABLE**DESCRIPTION**

V1, V2, V3

Components of vector \mathbf{v} for AOPT = 3

D1, D2, D3

Components of vector \mathbf{d} for AOPT = 2

BETA

Material angle in degrees for AOPT = 0 and 3. BETA may be over-written on the element card; see *ELEMENT_SHELL_BETA.

Card 6	1	2	3	4	5	6	7	8
Variable	RM-0	RM-45	RM-90	AG-0	AG-45	AG90		
Type	F	F	F	F	F	F		

VARIABLE**DESCRIPTION**RM- i Tensile strength for uniaxial testing at i° to rolling directionAG- i Uniform elongation for uniaxial testing at i° to rolling direction

Card 7	1	2	3	4	5	6	7	8
Variable	R00	R45	R90					
Type	F	F	F					

VARIABLE**DESCRIPTION**

R00

Lankford parameter R_{00}

R45

Lankford parameter R_{45}

R90

Lankford parameter R_{90}

Remarks:

1. **Yield Locus.** The yield locus description of this material is the same as for *MAT_VEGTER. The materials share the same Bézier interpolation for the section-wise definition of the yield locus.

The four characteristics stress states are predicted based on standard parameters from uniaxial tensile tests. This approach has been presented by Abspoel et al. (2017). Test data for 0°, 45°, and 90° to rolling direction must be given to account for anisotropic behavior of the material. The resulting formulation is then equivalent with *MAT_VEGTER_STANDARD and N = 2.

2. **Strain Hardening.** The Vegter yield function with isotropic hardening (ALPHA = 1) is given as:

$$\phi = \sigma_{\text{eq}}(\sigma_1, \sigma_2, \theta) - \sigma_y(\bar{\epsilon}^p, \dot{\bar{\epsilon}}^p, \dot{\epsilon})$$

with the equivalent stress σ_{eq} obtained from the appropriate Bézier function related to the current stress state. The uniaxial yield stress σ_y can be defined as yield stress curve $\sigma_y(\bar{\epsilon}^p)$ with LCID or as $\sigma_y(\bar{\epsilon}^p, \dot{\epsilon})$ with table LCID. In contrast to *MAT_VEGTER, this material also provides the Bergström-Van Liempt equation as third alternative:

$$\begin{aligned} \sigma_y(\bar{\epsilon}^p, \dot{\bar{\epsilon}}^p) = & \sigma_0 + \Delta\sigma_m \left[\beta(\bar{\epsilon}^p + \epsilon_0) + \left(1 - e^{-\Omega(\bar{\epsilon}^p + \epsilon_0)} \right)^n \right] \\ & + \sigma_0^* \left[1 + r_{\text{enth}} \ln \left(\frac{\dot{\bar{\epsilon}}^p}{\dot{\epsilon}_0} \right) \right]^m \end{aligned}$$

In case of kinematic hardening (ALPHA < 1), the standard stress tensor is replaced by a relative stress tensor, defined as the difference between the stress tensor and a back stress tensor.

***MAT_COHESIVE_MIXED_MODE**

This is Material Type 138. This model is a simplification of *MAT_COHESIVE_GENERAL, restricted to linear softening. It includes a bilinear traction-separation law with a quadratic mixed-mode delamination criterion and a damage formulation. This material model can only be used with cohesive element formulations; see the variable ELFORM in *SECTION_SOLID and *SECTION_SHELL.

Card 1	1	2	3	4	5	6	7	8
Variable	MID	RO	ROFLG	INTFAIL	EN	ET	GIC	GIIC
Type	A	F	I	F	F	F	F	F
Default	none	none	0	0.0	none	none	none	none

Card 2	1	2	3	4	5	6	7	8
Variable	XMU	T	S	UND	UTD	GAMMA		
Type	F	F	F	F	F	F		
Default	none	0.0	0.0	none	none	1.0		

VARIABLE

DESCRIPTION

MID Material identification. A unique number or label must be specified (see*PART).

RO Mass density

ROFLG Flag stating whether density is specified per unit area or volume:
EQ.0: Specified density is per unit volume (default).
EQ.1: Specified density is per unit area for controlling the mass of cohesive elements with an initial volume of zero.

INTFAIL The number of integration points required for the cohesive element to be deleted. The value of INTFAIL may range from 1 to 4, with 1 being the recommended value. This field also determines the integration scheme.

VARIABLE	DESCRIPTION
	LT.0.0: Employs a Newton-Cotes integration scheme. The element will be deleted when INTFAIL integration points have failed.
	EQ.0.0: Employs a Newton-Cotes integration scheme. The element will <i>not</i> be deleted even if it satisfies the failure criterion.
	GT.0.0: Employs a Gauss integration scheme. The element will be deleted when INTFAIL integration points have failed.
EN	The stiffness (units of stress / length) normal to the plane of the cohesive element
ET	The stiffness (units of stress / length) in the plane of the cohesive element
GIC	Energy release rate for mode I (units of stress × length). LT.0.0: Load curve ID = (-GIC), which defines the energy release rate for mode I as a function of element size.
GIIC	Energy release rate for mode II (units of stress × length). LT.0.0: Load curve ID = (-GIIC), which defines the energy release rate for mode II as a function of element size.
XMU	Exponent of the mixed mode criteria (see Remark 2)
T	Peak traction (stress units) in the normal direction. LT.0.0: Load curve ID = (-T), which defines peak traction in the normal direction as a function of element size. See Remark 4 . EQ.0.0: See Remark 1 . GT.0.0: Peak traction in the normal direction, <i>T</i>
S	Peak traction (stress units) in the tangential direction. LT.0.0: Load curve ID = (-S), which defines peak traction in the tangential direction as a function of element size. See Remark 4 . EQ.0.0: See Remark 1 . GT.0.0: Peak traction in the tangential direction, <i>S</i>

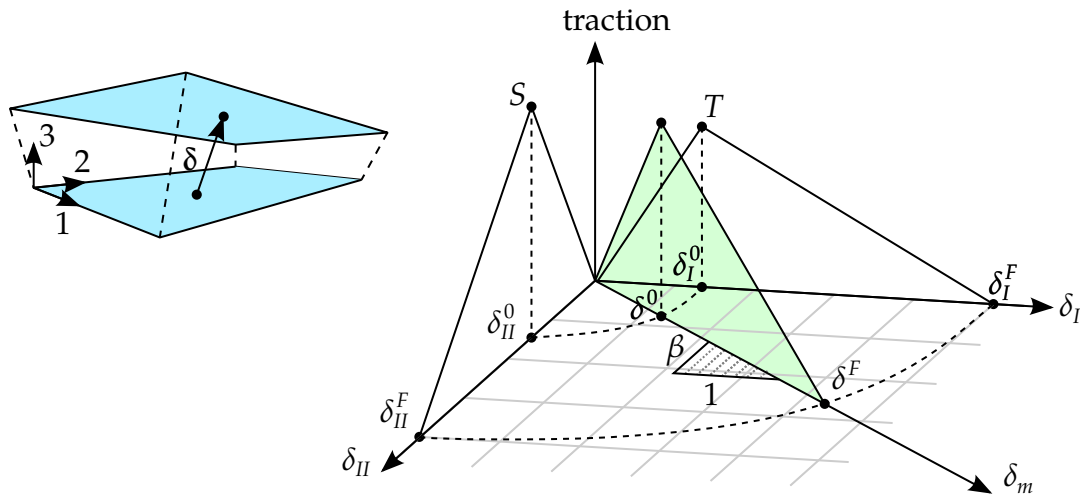

Figure M138-1. Mixed-mode traction-separation law

VARIABLE	DESCRIPTION
UND	Ultimate displacement in the normal direction
UTD	Ultimate displacement in the tangential direction
GAMMA	Additional exponent for Benzeggagh-Kenane law (default = 1.0)

Remarks:

- Ultimate Displacements.** The ultimate displacements in the normal and tangential directions are the displacements at the time when the material has failed completely, that is, the tractions are zero. The linear stiffness for loading followed by the linear softening during the damage provides an especially simple relationship among the energy release rates, peak tractions, and ultimate displacements:

$$GIC = T \times \frac{UND}{2}$$

$$GIIC = S \times \frac{UTD}{2}$$

If the peak tractions are not specified, they are computed from the ultimate displacements. See Fiolka and Matzenmiller [2005] and Gerlach, Fiolka and Matzenmiller [2005].

- Mixed-Mode Relative Displacement.** In this cohesive material model, the total mixed-mode relative displacement, δ_m , is defined as $\delta_m = \sqrt{\delta_I^2 + \delta_{II}^2}$, where $\delta_I = \delta_3$ is the separation in normal direction (mode I) and $\delta_{II} = \sqrt{\delta_1^2 + \delta_2^2}$ is the

separation in tangential direction (mode II). The mixed-mode damage initiation displacement δ^0 (onset of softening) is given by

$$\delta^0 = \delta_I^0 \delta_{II}^0 \sqrt{\frac{1 + \beta^2}{(\delta_{II}^0)^2 + (\beta \delta_I^0)^2}}$$

where $\delta_I^0 = T/EN$ and $\delta_{II}^0 = S/ET$ are the single mode damage initiation separations and $\beta = \delta_{II}/\delta_I$ is the “mode mixity” (see [Figure M138-1](#)). The ultimate mixed-mode displacement δ^F (total failure) for the power law ($XMU > 0$) is:

$$\delta^F = \frac{2(1 + \beta^2)}{\delta^0} \left[\left(\frac{EN}{GIC} \right)^{XMU} + \left(\frac{ET \times \beta^2}{GIIC} \right)^{XMU} \right]^{-1/XMU}$$

and, alternatively, for the Benzeggagh-Kenane law [[1996](#)] ($XMU < 0$):

$$\delta^F = \frac{2}{\delta^0 \left(\frac{1}{1 + \beta^2} EN^\gamma + \frac{\beta^2}{1 + \beta^2} ET^\gamma \right)^{1/\gamma}} \left[GIC + (GIIC - GIC) \left(\frac{\beta^2 \times ET}{EN + \beta^2 \times ET} \right)^{|XMU|} \right]$$

A reasonable choice for the exponent γ would be $GAMMA = 1.0$ (default) or $GAMMA = 2.0$.

3. **Interface Damage.** In this model, damage of the interface is considered, that is, irreversible conditions are enforced with loading/unloading paths coming from/pointing to the origin.
4. **Peak Traction as Load Curves.** Peak tractions T and/or S can be defined as functions of characteristic element length (square root of mid-surface area) using a load curve. This option helps obtain the same global responses (e.g. load-displacement curve) with coarse meshes when compared to a fine mesh solution. In general, lower peak traction values are needed for coarser meshes.
5. **Error Checks of Material Data.** We have implemented three error checks for this material model to ensure proper material data. Since the traction as a function of displacement curve is fairly simple (triangular shaped), we can check to ensure that the displacement, L , at the peak load (QMAX), is smaller than the ultimate distance for failure, u . See [Figure M138-2](#) for the used notation.

As shown in [Figure M138-2](#),

$$GC = \frac{1}{2} u \times QMAX$$

and

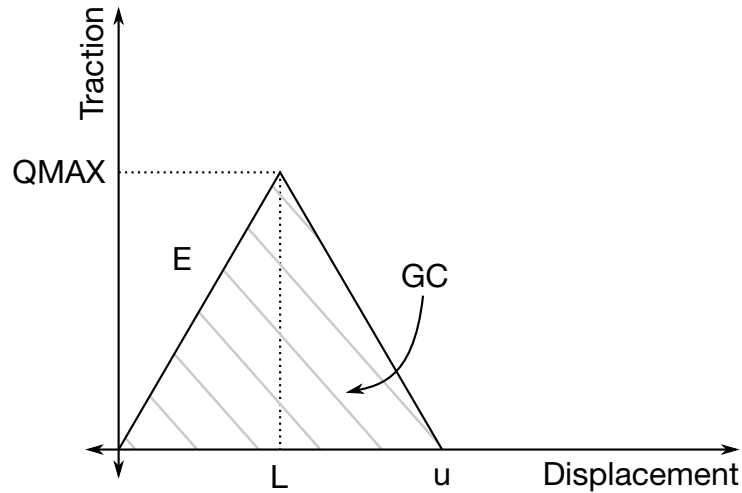

Figure M138-2. Bilinear traction-separation

$$L = \frac{QMAX}{E} .$$

To ensure the peak is not past the failure point, u/L must be larger than 1. Here,

$$u = \frac{2GC}{EL} ,$$

where GC is the energy release rate. This gives

$$\frac{u}{L} = \frac{2GC}{EL \times L} = \frac{2GC}{E \left(\frac{QMAX}{E} \right)^2} > 1 .$$

Based on this, LS-DYNA performs three error checks, one for tension, one for pure shear, and one for mixed modes:

$$\frac{u}{L} = \frac{\delta_I^F}{\delta_I^0} = \frac{2GIC}{EN \left(\frac{T}{EN} \right)^2} > 1$$

$$\frac{u}{L} = \frac{\delta_{II}^F}{\delta_{II}^0} = \frac{2GIIC}{ET \left(\frac{S}{ET} \right)^2} > 1$$

$$\frac{u}{L} = \frac{\delta^F}{\delta^0} > 1$$

In this last equation, we did not perform the substitution as the equations are complicated and depend on the sign of XMU (see [Remark 2](#)). The value of XMU significantly affects δ^F and should be chosen carefully. Because this check occurs during initialization, LS-DYNA computes the mode-mixity, β , using the displacements at failure given in input. Thus, it does not reflect any specific loading scenario.

***MAT_MODIFIED_FORCE_LIMITED**

This is Material Type 139. This material which is for the Belytschko-Schwer resultant beam is an extension of MAT_029. In addition to the original plastic hinge and collapse mechanisms of MAT_029, yield moments may be defined as a function of axial force. After a hinge forms, the moment transmitted by the hinge is limited by a moment-plastic rotation relationship.

Card Summary:

Card 1. This card is required.

MID	RO	E	PR	DF	IAFLC	YTFLAG	ASOFT
-----	----	---	----	----	-------	--------	-------

Card 2. This card is required.

M1	M2	M3	M4	M5	M6	M7	M8
----	----	----	----	----	----	----	----

Card 3. This card is required.

LC1	LC2	LC3	LC4	LC5	LC6	LC7	LC8
-----	-----	-----	-----	-----	-----	-----	-----

Card 4. This card is required.

LPS1	SFS1	LPS2	SFS2	YMS1	YMS2		
------	------	------	------	------	------	--	--

Card 5. This card is required.

LPT1	SFT1	LPT2	SFT2	YMT1	YMT2		
------	------	------	------	------	------	--	--

Card 6. This card is required.

LPR	SFR	YMR					
-----	-----	-----	--	--	--	--	--

Card 7. This card is required.

LYS1	SYS1	LYS2	SYS2	LYT1	SYT1	LYT2	SYT2
------	------	------	------	------	------	------	------

Card 8. This card is required.

LYR	SYR						
-----	-----	--	--	--	--	--	--

Card 9. This card is required.

HMS1_1	HMS1_2	HMS1_3	HMS1_4	HMS1_5	HMS1_6	HMS1_7	HMS1_8
--------	--------	--------	--------	--------	--------	--------	--------

Card 10. This card is required.

LPMS1_1	LPMS1_2	LPMS1_3	LPMS1_4	LPMS1_5	LPMS1_6	LPMS1_7	LPMS1_8
---------	---------	---------	---------	---------	---------	---------	---------

Card 11. This card is required.

HMS2_1	HMS2_2	HMS2_3	HMS2_4	HMS2_5	HMS2_6	HMS2_7	HMS2_8
--------	--------	--------	--------	--------	--------	--------	--------

Card 12. This card is required.

LPMS2_1	LPMS2_2	LPMS2_3	LPMS2_4	LPMS2_5	LPMS2_6	LPMS2_7	LPMS2_8
---------	---------	---------	---------	---------	---------	---------	---------

Card 13. This card is required.

HMT1_1	HMT1_2	HMT1_3	HMT1_4	HMT1_5	HMT1_6	HMT1_7	HMT1_8
--------	--------	--------	--------	--------	--------	--------	--------

Card 14. This card is required.

LPMT1_1	LPMT1_2	LPMT1_3	LPMT1_4	LPMT1_5	LPMT1_6	LPMT1_7	LPMT1_8
---------	---------	---------	---------	---------	---------	---------	---------

Card 15. This card is required.

HMT2_1	HMT2_2	HMT2_3	HMT2_4	HMT2_5	HMT2_6	HMT2_7	HMT2_8
--------	--------	--------	--------	--------	--------	--------	--------

Card 16. This card is required.

LPMT2_1	LPMT2_2	LPMT2_3	LPMT2_4	LPMT2_5	LPMT2_6	LPMT2_7	LPMT2_8
---------	---------	---------	---------	---------	---------	---------	---------

Card 17. This card is required.

HMR_1	HMR_2	HMR_3	HMR_4	HMR_5	HMR_6	HMR_7	HMR_8
-------	-------	-------	-------	-------	-------	-------	-------

Card 18. This card is required.

LPMR_1	LPMR_2	LPMR_3	LPMR_4	LPMR_5	LPMR_6	LPMR_7	LPMR_8
--------	--------	--------	--------	--------	--------	--------	--------

Data Card Definitions:

Card 1	1	2	3	4	5	6	7	8
Variable	MID	RO	E	PR	DF	IAFLC	YTFLAG	ASOFT
Type	A	F	F	F	F	I	F	F
Default	none	none	none	none	0.0	0	0.0	0.0

VARIABLE**DESCRIPTION**

MID	Material identification. A unique number or label must be specified.
RO	Mass density
E	Young's modulus
PR	Poisson's ratio
DF	Damping factor; see Remark 2 . <i>A proper control for the timestep must be maintained by the user.</i>
IAFLC	Axial load curve option: EQ.0: Axial load curves are force as a function of strain. EQ.1: Axial load curves are force as a function of change in length.
YTFLAG	Flag to allow beam to yield in tension: EQ.0.0: Beam does not yield in tension. EQ.1.0: Beam can yield in tension.
ASOFT	Axial elastic softening factor applied once hinge has formed. When a hinge has formed, the stiffness is reduced by this factor. If zero, this factor is ignored.

Card 2	1	2	3	4	5	6	7	8
Variable	M1	M2	M3	M4	M5	M6	M7	M8
Type	F	F	F	F	F	F	F	F
Default	none	0	0	0	0	0	0	0

VARIABLE

DESCRIPTION

M1, M2,
..., M8

Applied end moment for force as a function of strain/change in length curve. At least one moment must be defined with a maximum of 8. The values should be in ascending order.

Card 3	1	2	3	4	5	6	7	8
Variable	LC1	LC2	LC3	LC4	LC5	LC6	LC7	LC8
Type	I	I	I	I	I	I	I	I
Default	none	0	0	0	0	0	0	0

VARIABLE

DESCRIPTION

LC1, LC2,
..., LC8

Load curve ID (see *DEFINE_CURVE) defining axial force as a function of strain/change in length (see IAFLC) for the corresponding applied end moment. Define the same number as end moments. Each curve must contain the same number of points.

Card 4	1	2	3	4	5	6	7	8
Variable	LPS1	SFS1	LPS2	SFS2	YMS1	YMS2		
Type	I	F	I	F	F	F		
Default	0	1.0	LPS1	1.0	10 ²⁰	YMS1		

VARIABLE	DESCRIPTION
LPS1	Load curve ID for plastic moment as a function of rotation about the <i>s</i> -axis at node 1. If zero, this load curve is ignored.
SFS1	Scale factor for plastic moment as a function of rotation curve about the <i>s</i> -axis at node 1.
LPS2	Load curve ID for plastic moment as a function of rotation about the <i>s</i> -axis at node 2. The default is LPS1.
SFS2	Scale factor for plastic moment as a function of rotation curve about the <i>s</i> -axis at node 2. Default: SFS1.
YMS1	Yield moment about the <i>s</i> -axis at node 1 for interaction calculations (default set to 10^{20} to prevent interaction)
YMS2	Yield moment about the <i>s</i> -axis at node 2 for interaction calculations (default set to YMS1)

Card 5	1	2	3	4	5	6	7	8
Variable	LPT1	SFT1	LPT2	SFT2	YMT1	YMT2		
Type	I	F	I	F	F	F		
Default	0	1.0	LPT1	1.0	10^{20}	YMT1		

VARIABLE	DESCRIPTION
LPT1	Load curve ID for plastic moment as a function of rotation about the <i>t</i> -axis at node 1. If zero, this load curve is ignored.
SFT1	Scale factor for plastic moment as a function of rotation curve about the <i>t</i> -axis at node 1. Default = 1.0.
LPT2	Load curve ID for plastic moment as a function of rotation about the <i>t</i> -axis at node 2. Default: LPT1.
SFT2	Scale factor for plastic moment as a function of rotation curve about the <i>t</i> -axis at node 2. Default: SFT1.
YMT1	Yield moment about the <i>t</i> -axis at node 1 for interaction calculations (default set to 10^{20} to prevent interactions)

VARIABLE

DESCRIPTION

YMT2 Yield moment about the *t*-axis at node 2 for interaction calculations (default set to YMT1)

Card 6	1	2	3	4	5	6	7	8
Variable	LPR	SFR	YMR					
Type	I	F	F					
Default	0	1.0	10 ²⁰					

VARIABLE

DESCRIPTION

LPR Load curve ID for plastic torsional moment as a function of rotation. If zero, this load curve is ignored.

SFR Scale factor for plastic torsional moment as a function of rotation (default = 1.0)

YMR Torsional yield moment for interaction calculations (default set to 10²⁰ to prevent interaction)

Card 7	1	2	3	4	5	6	7	8
Variable	LYS1	SYS1	LYS2	SYS2	LYT1	SYT1	LYT2	SYT2
Type	I	F	I	F	I	F	I	F
Default	0	1.0	0	1.0	0	1.0	0	1.0

VARIABLE

DESCRIPTION

LYS1 ID of curve defining yield moment as a function of axial force for the *s*-axis at node 1

SYS1 Scale factor applied to load curve LYS1

LYS2 ID of curve defining yield moment as a function of axial force for the *s*-axis at node 2

VARIABLE	DESCRIPTION
SYS2	Scale factor applied to load curve LYS2
LYT1	ID of curve defining yield moment as a function of axial force for the t -axis at node 1
SYT1	Scale factor applied to load curve LYT1
LYT2	ID of curve defining yield moment as a function of axial force for the t -axis at node 2
SYT2	Scale factor applied to load curve LYT2

Card 8	1	2	3	4	5	6	7	8
Variable	LYR	SYR						
Type	I	F						
Default	0	1.0						

VARIABLE	DESCRIPTION
LYR	ID of curve defining yield moment as a function of axial force for the torsional axis.
SYR	Scale factor applied to load curve LYR.

Card 9	1	2	3	4	5	6	7	8
Variable	HMS1_1	HMS1_2	HMS1_3	HMS1_4	HMS1_5	HMS1_6	HMS1_7	HMS1_8
Type	F	F	F	F	F	F	F	F
Default	0.0	0.0	0.0	0.0	0.0	0.0	0.0	0.0

VARIABLE	DESCRIPTION
HMS1 _{<i>n</i>}	Hinge moment for the s -axis at node 1

Card 10	1	2	3	4	5	6	7	8
Variable	LPMS1_1	LPMS1_2	LPMS1_3	LPMS1_4	LPMS1_5	LPMS1_6	LPMS1_7	LPMS1_8
Type	I	I	I	I	I	I	I	I
Default	0	0	0	0	0	0	0	0

VARIABLE

DESCRIPTION

LPMS1_n ID of curve defining plastic moment as a function of plastic rotation for the *s*-axis at node 1 for hinge moment HMS1_n

Card 11	1	2	3	4	5	6	7	8
Variable	HMS2_1	HMS2_2	HMS2_3	HMS2_4	HMS2_5	HMS2_6	HMS2_7	HMS2_8
Type	F	F	F	F	F	F	F	F
Default	0.0	0.0	0.0	0.0	0.0	0.0	0.0	0.0

VARIABLE

DESCRIPTION

HMS2_n Hinge moment for the *s*-axis at node 2

Card 12	1	2	3	4	5	6	7	8
Variable	LPMS2_1	LPMS2_2	LPMS2_3	LPMS2_4	LPMS2_5	LPMS2_6	LPMS2_7	LPMS2_8
Type	I	I	I	I	I	I	I	I
Default	0	0	0	0	0	0	0	0

VARIABLE

DESCRIPTION

LPMS2_n ID of curve defining plastic moment as a function of plastic rotation for the *s*-axis at node 2 for hinge moment HMS2_n

Card 13	1	2	3	4	5	6	7	8
Variable	HMT1_1	HMT1_2	HMT1_3	HMT1_4	HMT1_5	HMT1_6	HMT1_7	HMT1_8
Type	F	F	F	F	F	F	F	F
Default	0.0	0.0	0.0	0.0	0.0	0.0	0.0	0.0

VARIABLE**DESCRIPTION**

HMT1_*n* Hinge moment for the *t*-axis at node 1

Card 14	1	2	3	4	5	6	7	8
Variable	LPMT1_1	LPMT1_2	LPMT1_3	LPMT1_4	LPMT1_5	LPMT1_6	LPMT1_7	LPMT1_8
Type	I	I	I	I	I	I	I	I
Default	0	0	0	0	0	0	0	0

VARIABLE**DESCRIPTION**

LPMT1_*n* ID of curve defining plastic moment as a function of plastic rotation for the *t*-axis at node 1 for hinge moment HMT1_*n*

Card 15	1	2	3	4	5	6	7	8
Variable	HMT2_1	HMT2_2	HMT2_3	HMT2_4	HMT2_5	HMT2_6	HMT2_7	HMT2_8
Type	F	F	F	F	F	F	F	F
Default	0.0	0.0	0.0	0.0	0.0	0.0	0.0	0.0

VARIABLE**DESCRIPTION**

HMT2_*n* Hinge moment for the *t*-axis at node 2

Card 16	1	2	3	4	5	6	7	8
Variable	LPMT2_1	LPMT2_2	LPMT2_3	LPMT2_4	LPMT2_5	LPMT2_6	LPMT2_7	LPMT2_8
Type	I	I	I	I	I	I	I	I
Default	0	0	0	0	0	0	0	0

VARIABLE**DESCRIPTION**

LPMT2_*n* ID of curve defining plastic moment as a function of plastic rotation for the *t*-axis at node 2 for hinge moment HMT2_*n*

Card 17	1	2	3	4	5	6	7	8
Variable	HMR_1	HMR_2	HMR_3	HMR_4	HMR_5	HMR_6	HMR_7	HMR_8
Type	F	F	F	F	F	F	F	F
Default	0.0	0.0	0.0	0.0	0.0	0.0	0.0	0.0

VARIABLE**DESCRIPTION**

HMR_*n* Hinge moment for the torsional axis

Card 18	1	2	3	4	5	6	7	8
Variable	LPMR_1	LPMR_2	LPMR_3	LPMR_4	LPMR_5	LPMR_6	LPMR_7	LPMR_8
Type	I	I	I	I	I	I	I	I
Default	0	0	0	0	0	0	0	0

VARIABLE**DESCRIPTION**

LPMR_*n* ID of curve defining plastic moment as a function of plastic rotation for the torsional axis for hinge moment HMR_*n*

Remarks:

1. **Load Curves.** This material model is available for the Belytschko resultant beam element only. Plastic hinges form at the ends of the beam when the moment reaches the plastic moment. The plastic moment as a function of rotation relationship is specified by the user in the form of a load curve and scale factor. The points of the load curve are (plastic rotation in radians, plastic moment). Both quantities should be positive for all points, with the first point being (zero, initial plastic moment). Within this constraint any form of characteristic may be used, including flat or falling curves. Different load curves and scale factors may be specified at each node and about each of the local s and t axes.

Axial collapse occurs when the compressive axial load reaches the collapse load. Collapse load as a function of collapse deflection is specified in the form of a load curve. The points of the load curve are either (true strain, collapse force) or (change in length, collapse force). Both quantities should be entered as positive for all points and will be interpreted as compressive. The first point should be (zero, initial collapse load).

The collapse load may vary with end moment as well as with deflections. In this case several load-deflection curves are defined, each corresponding to a different end moment. Each load curve should have the same number of points and the same deflection values. The end moment is defined as the average of the absolute moments at each end of the beam and is always positive.

2. **Damping.** Stiffness-proportional damping may be added using the damping factor λ . This is defined as follows:

$$\lambda = \frac{2 \times \zeta}{\omega}$$

where ζ is the damping factor at the reference frequency ω (in radians per second). For example, if 1% damping at 2Hz is required

$$\lambda = \frac{2 \times 0.01}{2\pi \times 2} = 0.001592$$

If damping is used, a small time step may be required. LS-DYNA does not check this so to avoid instability it may be necessary to control the time step using a load curve. As a guide, the time step required for any given element is multiplied by $0.3L/c\lambda$ when damping is present (L = element length, c = sound speed).

3. **Moment Interaction.** Plastic hinges can form due to the combined action of moments about the three axes. This facility is activated only when yield moments are defined in the material input. A hinge forms when the following condition is first satisfied.

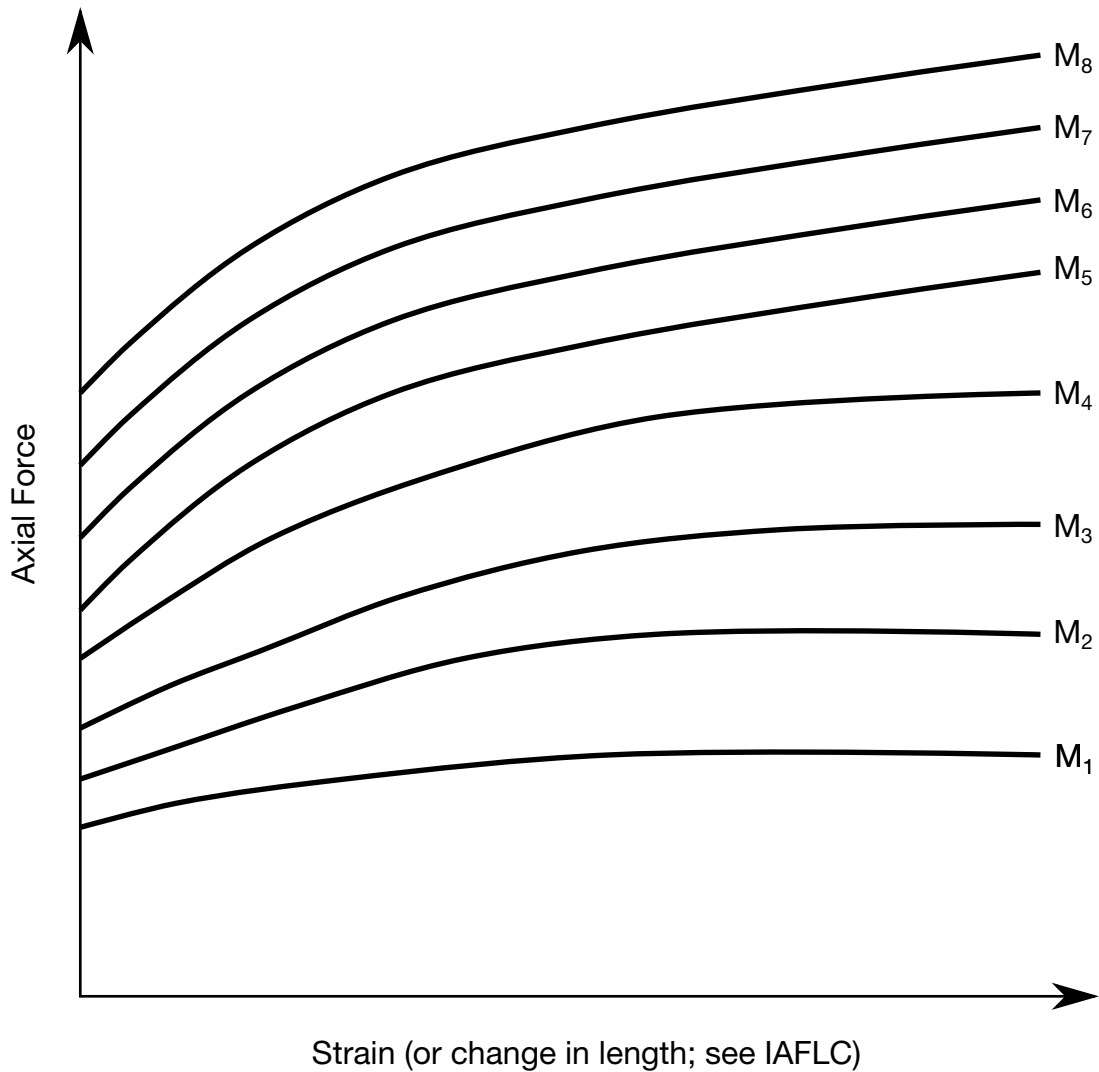

Figure M139-1. The force magnitude is limited by the applied end moment. For an intermediate value of the end moment LS-DYNA interpolates between the curves to determine the allowable force value.

$$\left(\frac{M_r}{M_{r\text{yield}}}\right)^2 + \left(\frac{M_s}{M_{s\text{yield}}}\right)^2 + \left(\frac{M_t}{M_{t\text{yield}}}\right)^2 \geq 1 ,$$

where

M_r, M_s, M_t = current moment

$M_{r\text{yield}}, M_{s\text{yield}}, M_{t\text{yield}}$ = yield moment

Note that scale factors for hinge behavior defined in the input will also be applied to the yield moments: for example, $M_{s\text{yield}}$ in the above formula is given by the input yield moment about the local axis times the input scale factor for the local s -axis. For strain-softening characteristics, the yield moment should generally be set equal to the initial peak of the moment-rotation load curve.

On forming a hinge, upper limit moments are set. These are given by

$$M_{r_{upper}} = \max \left(M_r, \frac{M_{r_{yield}}}{2} \right)$$

with similar conditions holding for $M_{s_{upper}}$ and $M_{t_{upper}}$. Thereafter the plastic moments will be given by

$$M_{r_p} = \min(M_{r_{upper}}, M_{r_{curve}}) ,$$

where M_{r_p} is the current plastic moment and $M_{r_{curve}}$ is the moment from the load curve at the current rotation scaled by the scale factor. M_{s_p} and M_{t_p} satisfy similar conditions. M_{s_p} and M_{t_p} satisfy similar conditions.

This provides an upper limit to the moment that can be generated; it represents the softening effect of local buckling at a hinge site. Thus, if a member is bent about the local s -axis, it will then be weaker in torsion and about its local t -axis. For moments-softening curves, the effect is to trim off the initial peak (although if the curves subsequently harden, the final hardening will also be trimmed off).

It is not possible to make the plastic moment vary with the current axial load, but it is possible to make hinge formation a function of axial load and subsequent plastic moment a function of the moment at the time the hinge formed. This is discussed in [Remark 4](#).

4. **Independent Plastic Hinge Formation.** In addition to the moment interaction equation, Cards 7 through 18 allow plastic hinges to form independently for the s -axis and t -axis at each end of the beam as well as for the torsional axis. A plastic hinge is assumed to form if any component of the current moment exceeds the yield moment as defined by the yield moment as a function axial force curves input on cards 7 and 8. If any of the 5 curves is omitted, a hinge will not form for that component. The curves can be defined for both compressive and tensile axial forces. If the axial force falls outside the range of the curve, the first or last point in the curve will be used. A hinge forming for one component of moment does not affect the other components.

Upon forming a hinge, the magnitude of that component of moment will not be permitted to exceed the current plastic moment. The current plastic moment is obtained by interpolating between the plastic moment as a function of plastic rotation curves input on cards 10, 12, 14, 16, or 18. Curves may be input for up to 8 hinge moments, where the hinge moment is defined as the yield moment at the time that the hinge formed. Curves must be input in order of increasing hinge moment and each curve should have the same plastic rotation values. The first or last curve will be used if the hinge moment falls outside the range of the curves. If no curves are defined, the plastic moment is obtained from the curves

on cards 4 through 6. The plastic moment is scaled by the scale factors on lines 4 to 6.

A hinge will form if either the independent yield moment is exceeded or if the moment interaction equation is satisfied. If both are true, the plastic moment will be set to the minimum of the interpolated value and M_{r_p} .

***MAT_VACUUM**

This is Material Type 140. This model is a dummy material representing a vacuum in a multi-material Euler/ALE model. Instead of using ELFORM = 12 (under *SECTION_SOLID), it is better to use ELFORM = 11 with the void material defined as the vacuum material.

Card 1	1	2	3	4	5	6	7	8
Variable	MID	RHO						
Type	A	F						

VARIABLE**DESCRIPTION**

MID	Material identification. A unique number or label must be specified (see *PART).
RHO	Estimated material density. This is used only as a stability check.

Remarks:

The vacuum density is estimated. It should be small relative compared to air in the model (possibly at least order of magnitude 10^3 to 10^6 lighter than air).

***MAT_RATE_SENSITIVE_POLYMER**

This is Material Type 141. This model, called the modified Ramaswamy-Stouffer model, is for the simulation of an isotropic ductile polymer with strain rate effects. See references; Stouffer and Dame [1996] and Goldberg and Stouffer [1999]. Uniaxial test data is used to fit the material parameters. This material model was implemented by Professor Ala Tabiei.

Card 1	1	2	3	4	5	6	7	8
Variable	MID	RO	E	PR	Do	N	ZO	Q
Type	A	F	F	F	F	F	F	F

Card 2	1	2	3	4	5	6	7	8
Variable	OMEGA							
Type	F							

VARIABLE**DESCRIPTION**

MID	Material identification. A unique number or label must be specified (see*PART).
RO	Mass density
E	Elastic modulus
PR	Poisson's ratio
Do	Reference strain rate (= 1000 × max strain rate used in the test)
N	Exponent (see inelastic strain rate equation below)
ZO	Initial hardness of material, Z_o
Q	Material constant, q (see equations below)
OMEGA	Maximum internal stress, Ω_m

Remarks:

The inelastic strain rate is defined as:

$$\dot{\varepsilon}_{ij}^I = D_o \exp \left[-0.5 \left(\frac{Z_o^2}{3K_2} \right)^N \right] \left(\frac{S_{ij} - \Omega_{ij}}{\sqrt{K_2}} \right)$$

where the K_2 term is given as:

$$K_2 = 0.5(S_{ij} - \Omega_{ij})(S_{ij} - \Omega_{ij})$$

and represents the second invariant of the overstress tensor. The elastic components of the strain are added to the inelastic strain to obtain the total strain. The following relationship defines the back stress variable rate:

$$\dot{\Omega}_{ij} = \frac{2}{3}q\Omega_m\dot{\varepsilon}_{ij}^I - q\Omega_{ij}\dot{\varepsilon}_e^I$$

where q is a material constant, Ω_m is a material constant that represents the maximum value of the internal stress, and $\dot{\varepsilon}_e^I$ is the effective inelastic strain rate.

***MAT_TRANSVERSELY_ISOTROPIC_CRUSHABLE_FOAM**

This is Material Type 142. This model is for an extruded foam material that is transversely isotropic, crushable, and of low density with no significant Poisson effect. This material is used in energy-absorbing structures to enhance automotive safety in low velocity (bumper impact) and medium high velocity (interior head impact and pedestrian safety) applications. The formulation of this foam is due to Hirth, Du Bois, and Weimar and is documented by Du Bois [2001].

This material is not wholly isotropic since the extrusion direction is preferred. The properties in directions orthogonal to the extrusion direction are, however, the same. In other words, the material is isotropic in all transversal directions to extrusion.

This material is available for solid elements and thick shell formulations 3, 5 and 7.

Card 1	1	2	3	4	5	6	7	8
Variable	MID	RO	E11	E22	E12	E23	G	K
Type	A	F	F	F	F	F	F	F

Card 2	1	2	3	4	5	6	7	8
Variable	I11	I22	I12	I23	IAA	NSYM	ANG	MU
Type	I	I	I	I	I	I	F	F

Card 3	1	2	3	4	5	6	7	8
Variable	AOPT	ISCL	BETA	MACF				
Type	F	I	F	I				

Card 4	1	2	3	4	5	6	7	8
Variable	XP	YP	ZP	A1	A2	A3		
Type	F	F	F	F	F	F		

Card 5	1	2	3	4	5	6	7	8
Variable	D1	D2	D3	V1	V2	V3		
Type	F	F	F	F	F	F		

VARIABLE**DESCRIPTION**

MID	Material identification. A unique number or label must be specified (see *PART).
RO	Mass density
E11	Elastic modulus in axial direction
E22	Elastic modulus in transverse direction (E22 = E33)
E12	Elastic shear modulus (E12 = E31)
E23	Elastic shear modulus in transverse plane
G	Shear modulus
K	Bulk modulus for contact stiffness
I11	Load curve for nominal axial stress as a function of volumetric strain
I22	Load curve ID for nominal transverse stresses as a function of volumetric strain (I22 = I33)
I12	Load curve ID for shear stress component 12 and 31 as a function of volumetric strain (I12 = I31)
I23	Load curve ID for shear stress component 23 as a function of volumetric strain
IAA	Load curve ID (optional) for nominal stress as a function of volumetric strain for load at angle, ANG, relative to the material <i>a</i> -axis
NSYM	Set to unity for a symmetric yield surface in volumetric compression and tension direction
ANG	Angle corresponding to load curve ID, IAA

VARIABLE	DESCRIPTION
MU	<p>Damping coefficient for tensor viscosity which acts in both tension and compression. Recommended values vary between 0.05 to 0.10. If zero, bulk viscosity is used instead of tensor viscosity. Bulk viscosity creates a pressure as the element compresses that is added to the normal stresses which can have the effect of creating transverse deformations when none are expected.</p>
AOPT	<p>Material axes option (see MAT_OPTIONTROPIC_ELASTIC, particularly the Material Directions section, for details):</p> <p>EQ.0.0: Locally orthotropic with material axes determined by element nodes 1, 2, and 4, as with *DEFINE_COORDINATE_NODES.</p> <p>EQ.1.0: Locally orthotropic with material axes determined by a point, P, in space and the global location of the element center; this is the \mathbf{a}-direction. This option is for solid elements only.</p> <p>EQ.2.0: Globally orthotropic with material axes determined by vectors defined below, as with *DEFINE_COORDINATE_VECTOR</p> <p>EQ.3.0: Locally orthotropic material axes determined by a vector \mathbf{v} and the normal vector to the plane of the element. The plane of a solid element is the midsurface between the inner surface and outer surface defined by the first four nodes and the last four nodes of the connectivity of the element, respectively. Thus, for solid elements, AOPT = 3 is only available for hexahedrons. \mathbf{a} is determined by taking the cross product of \mathbf{v} with the normal vector, \mathbf{b} is determined by taking the cross product of the normal vector with \mathbf{a}, and \mathbf{c} is the normal vector. Then \mathbf{a} and \mathbf{b} are rotated about \mathbf{c} by an angle BETA. BETA may be set in the keyword input for the element or in the input for this keyword. Note that for solids, the material axes may be switched depending on the choice of MACF. The switch may occur before or after applying BETA depending on the value of MACF.</p> <p>EQ.4.0: Locally orthotropic in a cylindrical coordinate system with the material axes determined by a vector \mathbf{v}, and an originating point, P, which define the centerline axis. This option is for solid elements only.</p>

VARIABLE	DESCRIPTION
	LT.0.0: The absolute value of AOPT is a coordinate system ID number (CID on *DEFINE_COORDINATE_OPTION).
ISCL	Load curve ID for the strain rate scale factor as a function of the volumetric strain rate. The yield stress is scaled by the value specified by the load curve.
BETA	Material angle in degrees for AOPT = 0 (tshells only) and AOPT = 3 (all element types). This angle may be overridden on the element card; see *ELEMENT_TSHELL_BETA and *ELEMENT_SOLID_ORTHO.
MACF	Material axes change flag for solid elements: EQ.-4: Switch material axes <i>b</i> and <i>c</i> before BETA rotation EQ.-3: Switch material axes <i>a</i> and <i>c</i> before BETA rotation EQ.-2: Switch material axes <i>a</i> and <i>b</i> before BETA rotation EQ.1: No change, default EQ.2: Switch material axes <i>a</i> and <i>b</i> after BETA rotation EQ.3: Switch material axes <i>a</i> and <i>c</i> after BETA rotation EQ.4: Switch material axes <i>b</i> and <i>c</i> after BETA rotation <p>Figure M2-2 indicates when LS-DYNA applies MACF during the process to obtain the final material axes. If BETA on *ELEMENT_SOLID_{OPTION} is defined, then that BETA is used for the rotation for all AOPT options. Otherwise, if AOPT = 3, the BETA input on Card 3 rotates the axes. For all other values of AOPT, the material axes will be switched as specified by MACF, but no BETA rotation will be performed.</p>
XP YP ZP	Coordinates of point <i>p</i> for AOPT = 1 and 4
A1 A2 A3	Components of vector a for AOPT = 2
D1 D2 D3	Components of vector d for AOPT = 2
V1 V2 V3	Define components of vector v for AOPT = 3 and 4

Remarks:

This model behaves in a more physical way for off axis loading the material than, for example, *MAT_HONEYCOMB which can exhibit nonphysical stiffening for loading

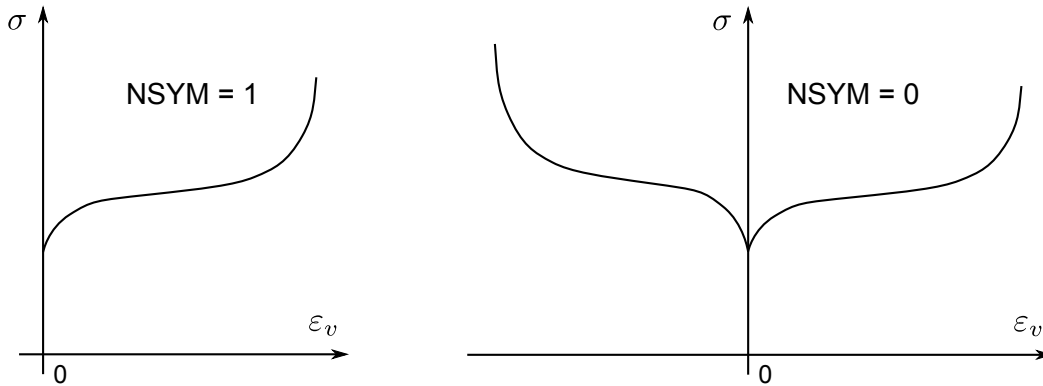

Figure M142-1. Differences between options NSYM = 1 and NSYM = 0.

conditions that are off axis. The curves given for I11, I22, I12 and I23 are used to define a yield surface of Tsai-Wu-type that bounds the deviatoric stress tensor. Hence the elastic parameters E11, E12, E22 and E23 as well as G and K must be defined in a consistent way.

For the curve definitions volumetric strain $\varepsilon_v = 1 - V/V_0$ is used as the abscissa parameter. If the symmetric option (NSYM = 1) is used, a curve must be provided for the first quadrant, but may also be defined in both the first and second quadrants. If NSYM = 0 is chosen, the curve definitions for I11, I22, I12 and I23 (and IAA) must be in the first and second quadrant as shown in [Figure M142-1](#).

Tensor viscosity, which is activated by a nonzero value for MU, is generally more stable than bulk viscosity. A damping coefficient less than 0.01 has little effect, and a value greater than 0.10 may cause numerical instabilities.

***MAT_WOOD_{OPTION}**

This is Material Type 143. This is a transversely isotropic material. It is available for solid elements, thick shell formulations 3, 5, and 7, and SPH elements. You have the option of inputting your own material properties (<BLANK>) or requesting default material properties for Southern yellow pine (PINE) or Douglas fir (FIR). This model was developed by Murray [2002] under a contract from the FHWA.

Available options include:

<BLANK>

PINE

FIR

Card Summary:

Card 1. This card is required.

MID	RO	NPLOT	ITERS	IRATE	GHARD	IFAIL	IVOL
-----	----	-------	-------	-------	-------	-------	------

Card 2a. This card is included if the keyword option is set to FIR or PINE.

MOIS	TEMP	QUAL_T	QUAL_C	UNITS	IQUAL		
------	------	--------	--------	-------	-------	--	--

Card 2b.1. This card is included if the keyword option is unset (<BLANK>).

EL	ET	GLT	GTR	PR			
----	----	-----	-----	----	--	--	--

Card 2b.2. This card is included if the keyword option is unset (<BLANK>).

XT	XC	YT	YC	SXY	SYZ		
----	----	----	----	-----	-----	--	--

Card 2b.3. This card is included if the keyword option is unset (<BLANK>).

GF1 \perp	GF2 \perp	BFIT	DMAX \perp	GF1 \perp	GF2 \perp	DFIT	DMAX \perp
-------------	-------------	------	--------------	-------------	-------------	------	--------------

Card 2b.4. This card is included if the keyword option is unset (<BLANK>).

FLPAR	FLPARC	POWPAR	FLPER	FLPERC	POWPER		
-------	--------	--------	-------	--------	--------	--	--

Card 2b.5. This card is included if the keyword option is unset (<BLANK>).

NPAR	CPAR	NPER	CPER				
------	------	------	------	--	--	--	--

Card 3. This card is required.

AOPT	MACF	BETA					
------	------	------	--	--	--	--	--

Card 4. This card is required.

XP	YP	ZP	A1	A2	A3		
----	----	----	----	----	----	--	--

Card 5. This card is required.

D1	D2	D3	V1	V2	V3		
----	----	----	----	----	----	--	--

Data Card Definitions:

Card 1	1	2	3	4	5	6	7	8
Variable	MID	RO	NPLOT	ITERS	IRATE	GHARD	IFAIL	IVOL
Type	A	F	I	I	I	F	I	I

VARIABLE

DESCRIPTION

MID	Material identification. A unique number or label must be specified (see*PART).
RO	Mass density
NPLOT	Controls what is written as component 7 to the d3plot database. LS-PrePost always blindly labels this component as effective plastic strain. EQ.1: Parallel damage (default) EQ.2: Perpendicular damage
ITERS	Number of plasticity algorithm iterations. The default is one iteration. GE.0: Original plasticity iteration developed by Murray [2002] LT.0: Plasticity iteration (return mapping) with non-associated flow direction for perpendicular yielding. The absolute value of ITERS is used as number of plasticity algorithm iterations.

VARIABLE	DESCRIPTION
----------	-------------

IRATE	<p>Rate effects option:</p> <p>EQ.0: Rate effects model turned off (default).</p> <p>EQ.1: Rate effects model turned on with the original rate dependence described by Murray [2002].</p> <p>EQ.2: Rate effects model turned on with Johnson-Cook like rate dependence of the strength parameters, as described below in Remark 2. Only works when <code>ITERS < 0</code> and the keyword option is unset (<BLANK>).</p>
GHARD	<p>Perfect plasticity override. Values greater than or equal to zero are allowed. Positive values model late time hardening in compression (an increase in strength with increasing strain). A zero value models perfect plasticity (no increase in strength with increasing strain). The default is zero.</p>
IFAIL	<p>Erosion perpendicular to the grain:</p> <p>EQ.0: No (default)</p> <p>EQ.1: Yes (not recommended except for debugging)</p>
IVOL	<p>Flag to invoke erosion based on negative volume or strain increments greater than 0.01:</p> <p>EQ.0: No, do not apply erosion criteria.</p> <p>EQ.1: Yes, apply erosion criteria.</p>

This card is included for the PINE and FIR keyword options.

Card 2a	1	2	3	4	5	6	7	8
Variable	MOIS	TEMP	QUAL_T	QUAL_C	UNITS	IQUAL		
Type	F	F	F	F	I	I		

VARIABLE	DESCRIPTION
----------	-------------

MOIS	<p>Percent moisture content. If left blank, the moisture content defaults to saturated at 30%.</p>
TEMP	<p>Temperature in °C. If left blank, the temperature defaults to room temperature at 20 °C</p>

VARIABLE**DESCRIPTION**

QUAL_T

Quality factor options (see [Remark 1](#)). These quality factors reduce the clear wood tension, shear, and compression strengths as a function of grade.

EQ.0.0: Grade 1, 1D, 2, 2D. Predefined strength reduction factors are:

Wood Type	Tension/Shear Factor	Compression Factor
Pine	0.47	0.63
Fir	0.40	0.73

EQ.-1.0: DS-65 or SEI STR (pine and fir). Predefined strength reduction factors are 0.80 in tension/shear and 0.93 in compression.

EQ.-2.0: Clear wood. No strength reduction factors are applied, that is, the reduction factors are 1.0 in tension, shear, and compression.

GT.0.0: User defined quality factor in tension/shear. Values between 0 and 1 are expected. Values greater than one are allowed but may not be realistic.

QUAL_C

User defined quality factor in compression (see [Remark 1](#)). This input value is used if QUAL_T > 0. Values between 0 and 1 are expected. Values greater than one are allowed but may not be realistic. If left blank, a default value of QUAL_C = QUAL_T is used.

UNITS

Units options:

EQ.0: GPa, mm, msec, Kg/mm³, kN.

EQ.1: MPa, mm, msec, g/mm³, Nt.

EQ.2: MPa, mm, sec, Mg/mm³, Nt.

EQ.3: Psi, inch, sec, lb-s²/inch⁴, lb

IQUAL

Apply quality factors perpendicular to the grain:

EQ.0: Yes (default)

EQ.1: No

This card is included if the keyword option is unset (<BLANK>).

Card 2b.1	1	2	3	4	5	6	7	8
Variable	EL	ET	GLT	GTR	PR			
Type	F	F	F	F	F			

VARIABLE**DESCRIPTION**

EL	Parallel normal modulus
ET	Perpendicular normal modulus
GLT	Parallel shear modulus (GLT = GLR)
GTR	Perpendicular shear modulus
PR	Parallel major Poisson's ratio

This card is included if the keyword option is unset (<BLANK>).

Card 2b.2	1	2	3	4	5	6	7	8
Variable	XT	XC	YT	YC	SXY	SYZ		
Type	F	F	F	F	F	F		

VARIABLE**DESCRIPTION**

XT	Parallel tensile strength
XC	Parallel compressive strength
YT	Perpendicular tensile strength
YC	Perpendicular compressive strength
SXY	Parallel shear strength
SYZ	Perpendicular shear strength

This card is included if the keyword option is unset (<BLANK>).

Card 2b.3	1	2	3	4	5	6	7	8
Variable	GF1	GF2	BFIT	DMAX	GF1 _⊥	GF2 _⊥	DFIT	DMAX _⊥
Type	F	F	F	F	F	F	F	F

VARIABLE**DESCRIPTION**

XT	Parallel tensile strength
GF1	Parallel fracture energy in tension
GF2	Parallel fracture energy in shear
BFIT	Parallel softening parameter
DMAX	Parallel maximum damage
GF1 _⊥	Perpendicular fracture energy in tension
GF2 _⊥	Perpendicular fracture energy in shear
DFIT	Perpendicular softening parameter

This card is included if the keyword option is unset (<BLANK>).

Card 2b.4	1	2	3	4	5	6	7	8
Variable	FLPAR	FLPARC	POWPAR	FLPER	FLPERC	POWPER		
Type	F	F	F	F	F	F		

VARIABLE**DESCRIPTION**

FLPAR	Rate effects parameter: IRATE.EQ.0: Ignored IRATE.EQ.1: Parallel fluidity parameter for tension and shear IRATE.EQ.2: Dimensionless parallel strain rate parameter for tension and shear (see Remark 2)
FLPARC	Rate effects parameter:

VARIABLE	DESCRIPTION
	IRATE.EQ.0: Ignored
	IRATE.EQ.1: Parallel fluidity parameter for compression
	IRATE.EQ.2: Dimensionless parallel strain rate parameter for compression (see Remark 2)
POWPAR	Rate effects parameter: IRATE.EQ.0: Ignored IRATE.EQ.1: Parallel power IRATE.EQ.2: Quasi-static threshold strain rate value in the parallel direction (see Remark 2)
FLPER	Rate effects parameter: IRATE.EQ.0: Ignored IRATE.EQ.1: Perpendicular fluidity parameter for tension and shear IRATE.EQ.2: Dimensionless perpendicular strain rate parameter for tension and shear (see Remark 2)
FLPERC	Rate effects parameter: IRATE.EQ.0: Ignored IRATE.EQ.1: Perpendicular fluidity parameter for compression IRATE.EQ.2: Dimensionless perpendicular strain rate parameter for compression (see Remark 2)
POWPER	Rate effects parameter: IRATE.EQ.0: Ignored IRATE.EQ.1: Perpendicular power IRATE.EQ.2: Quasi-static threshold strain rate value in the perpendicular direction (see Remark 2)

This card is included if the keyword option is unset (<BLANK>).

Card 2b.5	1	2	3	4	5	6	7	8
Variable	NPAR	CPAR	NPER	CPER				
Type	F	F	F	F				

VARIABLE**DESCRIPTION**

NPAR	Parallel hardening initiation
CPAR	Parallel hardening rate
NPER	Perpendicular hardening initiation
CPER	Perpendicular hardening rate

Card 3	1	2	3	4	5	6	7	8
Variable	AOPT	MACF	BETA					
Type	F	I	F					

VARIABLE**DESCRIPTION**

AOPT	<p>Material axes option (see MAT_OPTIONTROPIC_ELASTIC, particularly the Material Directions section, for details):</p> <p>EQ.0.0: Locally orthotropic with material axes determined by element nodes 1, 2, and 4, as with *DEFINE_COORDINATE_NODES.</p> <p>EQ.1.0: Locally orthotropic with material axes determined by a point, P, in space and the global location of the element center; this is the a-direction. This option is for solid elements only.</p> <p>EQ.2.0: Globally orthotropic with material axes determined by vectors defined below, as with *DEFINE_COORDINATE_VECTOR</p>
------	--

VARIABLE

DESCRIPTION

EQ.3.0: Locally orthotropic material axes determined by a vector \mathbf{v} and the normal vector to the plane of the element. The plane of a solid element is the midsurface between the inner surface and outer surface defined by the first four nodes and the last four nodes of the connectivity of the element, respectively. Thus, for solid elements, AOPT = 3 is only available for hexahedrons. \mathbf{a} is determined by taking the cross product of \mathbf{v} with the normal vector, \mathbf{b} is determined by taking the cross product of the normal vector with \mathbf{a} , and \mathbf{c} is the normal vector. Then \mathbf{a} and \mathbf{b} are rotated about \mathbf{c} by an angle BETA. BETA may be set in the keyword input for the element or in the input for this keyword. Note that for solids, the material axes may be switched depending on the choice of MACF. The switch may occur before or after applying BETA depending on the value of MACF.

EQ.4.0: Locally orthotropic in a cylindrical coordinate system with the material axes determined by a vector \mathbf{v} , and an originating point, P , which define the centerline axis. This option is for solid elements only.

LT.0.0: The absolute value of AOPT is a coordinate system ID number (CID on *DEFINE_COORDINATE_OPTION).

MACF

Material axes change flag for solid elements:

EQ.-4: Switch material axes b and c before BETA rotation

EQ.-3: Switch material axes a and c before BETA rotation

EQ.-2: Switch material axes a and b before BETA rotation

EQ.1: No change, default

EQ.2: Switch material axes a and b after BETA rotation

EQ.3: Switch material axes a and c after BETA rotation

EQ.4: Switch material axes b and c after BETA rotation

Figure M2-2 indicates when LS-DYNA applies MACF during the process to obtain the final material axes. If BETA on *ELEMENT_SOLID_{OPTION} is defined, then that BETA is used for the rotation for all AOPT options. Otherwise, if AOPT = 3, the BETA input on Card 3 rotates the axes. For all other values of AOPT, the material axes will be switched as specified by MACF, but no BETA rotation will be performed.

VARIABLE**DESCRIPTION**

BETA

Material angle in degrees for AOPT = 3. It may be overridden on the element card; see *ELEMENT_SOLID_ORTHO and *ELEMENT_TSHELL_BETA.

Card 4	1	2	3	4	5	6	7	8
Variable	XP	YP	ZP	A1	A2	A3		
Type	F	F	F	F	F	F		

VARIABLE**DESCRIPTION**

XP YP ZP

Coordinates of point p for AOPT = 1 and 4

A1 A2 A3

Components of vector \mathbf{a} for AOPT = 2

Card 5	1	2	3	4	5	6	7	8
Variable	D1	D2	D3	V1	V2	V3		
Type	F	F	F	F	F	F		

VARIABLE**DESCRIPTION**

D1 D2 D3

Components of vector \mathbf{d} for AOPT = 2

V1 V2 V3

Define components of vector \mathbf{v} for AOPT = 3 and 4

Remarks:

1. **Quality Factors.** Material property data is for clear wood (small samples without defects like knots), whereas real structures are composed of graded wood. Clear wood is stronger than graded wood. Quality factors (strength reduction factors) are applied to the clear wood strengths to account for reductions in strength as a function of grade. One quality factor (QUAL_T) is applied to the tensile and shear strengths. A second quality factor (QUAL_C) is applied to the compressive strengths. As an option, predefined quality factors are provided based on correlations between LS-DYNA calculations and test data for pine and fir posts impacted by bogie vehicles. By default, quality factors are applied to

both the parallel and perpendicular to the grain strengths. An option is available (IQUAL) to eliminate application perpendicular to the grain.

2. **Johnson-Cook Like Logarithmic Rate Dependence.** A Johnson-Cook like logarithmic rate dependence can be invoked by `IRATE = 2` when the keyword option is unset and `ITERS < 0`. In that case, the strength parameters are:

$$\begin{aligned}\hat{X}_T &= X_T \left(1 + \text{FLPAR} \times \ln \left(1 + \frac{\dot{\epsilon}}{\text{POWPAR}} \right) \right) \\ \hat{X}_C &= X_C \left(1 + \text{FLPARC} \times \ln \left(1 + \frac{\dot{\epsilon}}{\text{POWPAR}} \right) \right) \\ \hat{Y}_T &= Y_T \left(1 + \text{FLPER} \times \ln \left(1 + \frac{\dot{\epsilon}}{\text{POWPER}} \right) \right) \\ \hat{Y}_C &= Y_C \left(1 + \text{FLPERC} \times \ln \left(1 + \frac{\dot{\epsilon}}{\text{POWPER}} \right) \right) \\ \hat{S}_{XY} &= S_{XY} \left(1 + \text{FLPAR} \times \ln \left(1 + \frac{\dot{\epsilon}}{\text{POWPAR}} \right) \right) \\ \hat{S}_{YZ} &= S_{YZ} \left(1 + \text{FLPER} \times \ln \left(1 + \frac{\dot{\epsilon}}{\text{POWPER}} \right) \right)\end{aligned}$$

The strain rate parameters, `FLPAR`, `FLPARC`, `FLPER`, and `FLPERC`, are dimensionless (factors ≥ 0 that quantify the strain rate dependence). `POWPAR` and `POWPER` are quasi-static threshold strain rate values in the parallel and perpendicular directions with the units of $[\text{time}]^{-1}$. Variable $\dot{\epsilon}$ is an effective strain rate.

***MAT_PITZER_CRUSHABLE_FOAM**

This is Material Type 144. This model is for the simulation of isotropic crushable forms with strain rate effects. Uniaxial and triaxial test data have to be used. For the elastic response, the Poisson ratio is set to zero.

Card 1	1	2	3	4	5	6	7	8
Variable	MID	RO	K	G	PR	TY	SRTV	
Type	A	F	F	F	F	F	F	

Card 2	1	2	3	4	5	6	7	8
Variable	LCPY	LCUYS	LCSR	VC	DFLG			
Type	I	I	I	F	F			

VARIABLE**DESCRIPTION**

MID	Material identification. A unique number or label must be specified (see *PART).
RO	Mass density
K	Bulk modulus
G	Shear modulus
PR	Poisson's ratio
TY	Tension yield
SRTV	Young's modulus (E)
LCPY	Load curve ID giving pressure as a function of volumetric strain; see Figure M75-1 .
LCUYS	Load curve ID giving uniaxial stress as a function of volumetric strain; see Figure M75-1 .
LCSR	Load curve ID giving strain rate scale factor as a function of volumetric strain rate

VARIABLE	DESCRIPTION
VC	Viscous damping coefficient (.05 < recommended value < .50)
DFLG	Density flag: EQ.0.0: Use initial density. EQ.1.0: Use current density (larger step size with less mass scaling).

Remarks:

The logarithmic volumetric strain is defined in terms of the relative volume, V , as:

$$\gamma = -\ln(V) .$$

When defining the curves, the stress and strain pairs should be positive values starting with a volumetric strain value of zero.

*MAT_SCHWER_MURRAY_CAP_MODEL

This is Material Type 145. *MAT_145 is a Continuous Surface Cap Model and is a three invariant extension of *MAT_GEOLOGIC_CAP_MODEL (*MAT_025) that includes viscoplasticity for rate effects and damage mechanics to model strain softening. The primary references for the model are Schwer and Murray [1994], Schwer [1994], and Murray and Lewis [1994]. *MAT_145 was developed for geomaterials including soils, concrete, and rocks. We recommend using an updated version of a Continuous Surface Cap Model, *MAT_CSCM (*MAT_159), rather than this model, *MAT_SCHWER_MURRAY_CAP_MODEL (*MAT_145).

WARNING: No default input parameter values are assumed, but recommendations for the more obscure parameters are provided in the descriptions that follow.

Card Summary:

Card 1. This card is required.

MID	RO	SHEAR	BULK	GRUN	SHOCK	PORE	
-----	----	-------	------	------	-------	------	--

Card 2. This card is required.

ALPHA	THETA	GAMMA	BETA	EFIT	FFIT	ALPHAN	CALPHA
-------	-------	-------	------	------	------	--------	--------

Card 3. This card is required.

RO	XO	IROCK	SECP	AFIT	BFIT	RDAMO	
----	----	-------	------	------	------	-------	--

Card 4. This card is required.

W	D1	D2	NPLOT	EPSMAX	CFIT	DFIT	TFAIL
---	----	----	-------	--------	------	------	-------

Card 5. This card is required.

FAILFL	DBETA	DDELTA	VPTAU				
--------	-------	--------	-------	--	--	--	--

Card 6. This card is required.

ALPHA1	THETA1	GAMMA1	BETA1	ALPHA2	THETA2	GAMMA2	BETA2
--------	--------	--------	-------	--------	--------	--------	-------

Data Card Definitions:

Card 1	1	2	3	4	5	6	7	8
Variable	MID	RO	SHEAR	BULK	GRUN	SHOCK	PORE	
Type	A	F	F	F	F	F	F	

VARIABLE**DESCRIPTION**

MID	Material identification. A unique number or label must be specified (see *PART).
RO	Mass density
SHEAR	Shear modulus, G
BULK	Bulk modulus, K
GRUN	Gruneisen ratio (typically = 0), Γ
SHOCK	Shock velocity parameter (typically 0), S_l
PORE	Flag for pore collapse EQ.0.0: Pore collapse EQ.1.0: Constant bulk modulus (typical)

Card 2	1	2	3	4	5	6	7	8
Variable	ALPHA	THETA	GAMMA	BETA	EFIT	FFIT	ALPHAN	CALPHA
Type	F	F	F	F	F	F	F	F

VARIABLE**DESCRIPTION**

ALPHA	Shear failure parameter, α
THETA	Shear failure parameter, θ
GAMMA	Shear failure parameter, γ

VARIABLE	DESCRIPTION
BETA	Shear failure parameter, β $\sqrt{J'_2} = F_e(J_1) = \alpha - \gamma \exp(-\beta J_1) + \theta J_1$
EFIT	Dilation damage mechanics parameter (no damage = 1)
FFIT	Dilation damage mechanics parameter (no damage = 0)
ALPHAN	Kinematic strain hardening parameter, N^α
CALPHAN	Kinematic strain hardening parameter, c^α

Card 3	1	2	3	4	5	6	7	8
Variable	R0	X0	IROCK	SECP	AFIT	BFIT	RDAM0	
Type	F	F	F	F	F	F	F	

VARIABLE	DESCRIPTION
R0	Initial cap surface ellipticity, R
X0	Initial cap surface J_1 (mean stress) axis intercept, $X(\kappa_0)$
IROCK	Material flag: EQ.0: Soils (cap can contract) EQ.1: Rock/concrete
SECP	Shear enhanced compaction
AFIT	Ductile damage mechanics parameter (=1 no damage)
BFIT	Ductile damage mechanics parameter (=0 no damage)
RDAM0	Ductile damage mechanics parameter

Card 4	1	2	3	4	5	6	7	8
Variable	W	D1	D2	NPLOT	EPSMAX	CFIT	DFIT	TFAIL
Type	F	F	F	F	F	F	F	F

VARIABLE

DESCRIPTION

W	Plastic Volume Strain parameter, W
D1	Plastic Volume Strain parameter, D_1
D2	Plastic Volume Strain parameter, D_2 $\varepsilon_V^P = W \left\{ 1 - \exp \left\{ -D_1 [X(\kappa) - X(\kappa_0)] - D_2 [(X(\kappa) - X(\kappa_0))]^2 \right\} \right\}$
NPLOT	History variable post-processed as effective plastic strain. (See Table M145-1 for history variables available for plotting.)
EPSMAX	Maximum permitted strain increment: $\text{EQ.0.0: } \Delta \varepsilon_{\max} = 0.05(\alpha - N^\alpha - \gamma) \min\left(\frac{1}{G}, \frac{R}{9K}\right)$ (calculated default)
CFIT	Brittle damage mechanics parameter (= 1 no damage)
DFIT	Brittle damage mechanics parameter (= 0 no damage)
TFAIL	Tensile failure stress

Card 5	1	2	3	4	5	6	7	8
Variable	FAILFL	DBETA	DDELTA	VPTAU				
Type	F	F	F	F				

VARIABLE

DESCRIPTION

FAILFL	Flag controlling element deletion and effect of damage on stress (see Remark 1): $\text{EQ.1: } \sigma_{ij} \text{ reduces with increasing damage; element is deleted when fully damaged (default).}$
--------	---

VARIABLE	DESCRIPTION
	EQ.-1: σ_{ij} reduces with increasing damage; element is not deleted.
	EQ.2: S_{ij} reduces with increasing damage; element is deleted when fully damaged.
	EQ.-2: S_{ij} reduces with increasing damage; element is not deleted.
DBETA	Rounded vertices parameter, $\Delta\beta_0$
DDELTA	Rounded vertices parameter, δ
VPTAU	Viscoplasticity relaxation time parameter, τ

Card 6	1	2	3	4	5	6	7	8
Variable	ALPHA1	THETA1	GAMMA1	BETA1	ALPHA2	THETA2	GAMMA2	BETA2
Type	F	F	F	F	F	F	F	F

VARIABLE	DESCRIPTION
ALPHA1	Torsion scaling parameter, α_1 LT.0.0: ALPHA1 is the friction angle in degrees.
THETA1	Torsion scaling parameter, θ_1
GAMMA1	Torsion scaling parameter, γ_1
BETA1	Torsion scaling parameter, β_1 $Q_1 = \alpha_1 - \gamma_1 \exp(-\beta_1 J_1) + \theta_1 J_1 \theta_2$
ALPHA2	Tri-axial extension scaling parameter, α_2
THETA2	Tri-axial extension scaling parameter, θ_2
GAMMA2	Tri-axial extension scaling parameter, γ_2
BETA2	Tri-axial extension scaling parameter, β_2 $Q_2 = \alpha_2 - \gamma_2 \exp(-\beta_2 J_1) + \theta_2 J_1$

Remarks:

1. **Damage Accumulation and Element Deletion.** FAILFL controls whether the damage accumulation applies to either the total stress tensor, σ_{ij} , or the deviatoric stress tensor, S_{ij} . When FAILFL = 2, damage does not diminish the ability of the material to support hydrostatic stress.

FAILFL also serves as a flag to control element deletion. Fully damaged elements are deleted only if FAILFL is a positive value. When *MAT_145 is used with the ALE or EFG solvers, failed elements should not be eroded and so a negative value of FAILFL should be used.

2. **History Variables.** All the output parameters listed in [Table M145-1](#) are available for post-processing using LS-PrePost and its displayed list of history variables. The LS-DYNA input parameter NEIPH should be set to 22 on *DATABASE_EXTENT_BINARY.

History Variable #	Function	Description
1	$X(\kappa)$	J_1 intercept of cap surface
2	$L(\kappa)$	J_1 value at cap-shear surface intercept
3	R	Cap surface ellipticity
4	\tilde{R}	Rubin function
5	ε_v^p	Plastic volume strain
6		Yield flag (= 0 elastic)
7		Number of strain sub-increments
8	G^α	Kinematic hardening parameter
9	J_2^α	Kinematic hardening back stress
10		Effective strain rate
11		Ductile damage
12		Ductile damage threshold
13		Strain energy

History Variable #	Function	Description
14		Brittle damage
15		Brittle damage threshold
16		Brittle energy norm
17		J_1 (without visco-damage/plastic)
18		J_2' (without visco-damage/plastic)
19		J_3' (without visco-damage/plastic)
20		\hat{J}_3 (without visco-damage/plastic)
21	β	Lode angle
22	d	Maximum damage parameter

Table M145-1. Output variables for post-processing using NPLOT parameter.

3. **Sample Input for Concrete.** Gran and Senseny [1996] report the axial stress as a function of strain response for twelve unconfined compression tests of concrete, used in scale-model reinforced-concrete wall tests. The Schwer & Murray Cap Model parameters provided below were used, see Schwer [2001], to model the unconfined compression test stress-strain response for the nominal 40 MPa strength concrete reported by Gran and Senseny. The basic units for the provided parameters are length in millimeters (mm), time in milliseconds (msec), and mass in grams (g). This base unit set yields units of force in Newtons (N) and pressure in Mega-Pascals (MPa).

```
*MAT_SCHWER_MURRAY_CAP_MODEL
$   MID      RO      SHEAR      BULK      GRUN      SHOCK      PORE
$   1      2.3E-3  1.048E4  1.168E4  0.0      0.0      1.0
$   ALPHA    THETA    GAMMA    BETA      EFIT      FFIT      ALPHAN    CALPHA
$   190.0    0.0      184.2    2.5E-3    0.999    0.7      2.5      2.5E3
$   R0      X0      IROCK    SECP      AFIT      BFIT      RDAM0
$   5.0      100.0    1.0      0.0      0.999    0.3      0.94
$   W      D1      D2      NPLOT    EPSMAX    CFIT      DFIT      TFAIL
$   5.0E-2  2.5E-4  3.5E-7  23.0     0.0      1.0      300.0    7.0
$   FAILFG    DBETA    DDELTA    VPTAU
$   1.0      0.0      0.0      0.0
$   ALPHA1    THETA1    GAMMA1    BETA1    ALPHA2    THETA2    GAMMA2    BETA2
$   0.747    3.3E-4    0.17     5.0E-2    0.66     4.0E-4    0.16     5.0E-2
```

4. **User Input Parameters and System of Units.** Consider the following basic units:

Length: L (e.g. millimeters - mm)

Mass: M (e.g. grams - g)

Time: T (e.g. milliseconds - ms)

The following consistent unit systems can then be derived using Newton's Law, $F = Ma$:

Force: $F = ML/T^2$ [g-mm/ms² = Kg-m/s² = Newton - N]

Stress: $\sigma = F/L^2$ [N/mm² = 10⁶N/m² = 10⁶ Pascals = MPa]

Density: $\rho = M/L^3$ [g/mm³ = 10⁶ Kg/m³]

Variable	MID	RO	SHEAR	BULK	GRUN	SHOCK	PORE	
Units		Den- sity: M/L ³	Stress: F/L ²	Stress: F/L ²				
Variable	ALPHA	THETA	GAMMA	BETA	EFIT	FFIT	ALPHAN	CALPHA
Units	Stress: F/L ²		Stress: F/L ²	Stress ⁻¹ : L ² /F		Stress ^{-1/2} : L/F ^{1/2}	Stress: F/L ²	Stress: F/L ²
Variable	RO	X0	IROCK	SECP	AFIT	BFIT	RDAM0	
Units		Stress: F/L ²				Stress ^{-1/2} : L/F ^{1/2}	Stress ^{1/2} : F ^{1/2} /L	
Variable	W	D1	D2	NPLOT	MAXEPS	CFIT	DFIT	TFAIL
Units		Stress ⁻¹ : L ² /F	Stress ⁻² : L ⁴ /F ²				Stress ^{-1/2} : L/F ^{1/2}	Stress: F/L ²
Variable	FAILFG	DBETA	DDELTA	VPTAU				
Units		Angle: degrees		Time: T				
Variable	ALPHA1	THETA1	GAMMA1	BETA1	ALPHA2	THETA2	GAMMA2	BETA2
Units	Stress: F/L ²		Stress: F/L ²	Stress ⁻¹ : L ² /F	Stress: F/L ²		Stress: F/L ²	Stress ⁻¹ : L ² /F

***MAT_1DOF_GENERALIZED_SPRING**

This is Material Type 146. This is a linear spring or damper that allows different degrees-of-freedom at two nodes to be coupled.

Card 1	1	2	3	4	5	6	7	8
Variable	MID	RO	K	C	SCLN1	SCLN2	DOFN1	DOFN2
Type	A	F	F	F	F	F	I	I

Card 2	1	2	3	4	5	6	7	8
Variable	CID1	CID2						
Type	I	I						

VARIABLE**DESCRIPTION**

MID	Material identification. A unique number or label must be specified (see *PART).
RO	Mass density; see also volume in *SECTION_BEAM definition.
K	Spring stiffness
C	Damping constant
SCLN1	Scale factor on force at node 1. Default = 1.0.
SCLN2	Scale factor on force at node 2. Default = 1.0.
DOFN1	Active degree-of-freedom at node 1, a number between 1 to 6 where 1, 2 and 3 are the x , y , and z -translations and 4, 5, and 6 are the x , y , and z -rotations. If this parameter is defined in the *SECTION_BEAM definition or on the *ELEMENT_BEAM_SCALAR card, then the value here, if defined, is ignored.
DOFN2	Active degree-of-freedom at node 2, a number between 1 to 6 where 1, 2 and 3 are the x , y , and z -translations and 4, 5, and 6 are the x , y , and z -rotations. If this parameter is defined in the *SECTION_BEAM definition or on the *ELEMENT_BEAM_SCALAR card, then the value here, if defined, is ignored.

VARIABLE	DESCRIPTION
CID1	Local coordinate system at node 1. This coordinate system can be overwritten by a local system specified on the *ELEMENT_BEAM_SCALAR or *SECTION_BEAM keyword input. If no coordinate system is specified, the global system is used.
CID2	Local coordinate system at node 2. If CID2 = 0, CID2 = CID1.

***MAT_FHWA_SOIL**

This is Material Type 147. This is an isotropic material with damage and is available for solid elements. The model has a modified Mohr-Coulomb surface to determine the pressure dependent peak shear strength. It was developed for applications involving road-base soils by Lewis [1999] for the FHWA, who extended the work of Abbo and Sloan [1995] to include excess pore water effects.

Card 1	1	2	3	4	5	6	7	8
Variable	MID	RO	NPLOT	SPGRAV	RHOWAT	VN	GAMMAR	ITERMX
Type	A	F	I	F	F	F	F	I
Default	none	none	1	none	1.0	0.0	0.0	1

Card 2	1	2	3	4	5	6	7	8
Variable	K	G	PHIMAX	AHYP	COH	ECCEN	AN	ET
Type	F	F	F	F	F	F		
Default	none	none	none	none	none	none	none	none

Card 3	1	2	3	4	5	6	7	8
Variable	MCONT	PWD1	PWKSK	PWD2	PHIRES	DINT	VDFM	DAMLEV
Type	F	F	F	F	F	F	F	F
Default	none	none	none	none	0.0	none	none	none

Card 4	1	2	3	4	5	6	7	8
Variable	EPSMAX							
Type	F							
Default	none							

VARIABLE**DESCRIPTION**

MID	Material identification. A unique number or label must be specified (see *PART).
RO	Mass density
NPLOT	Controls what is written as component 7 to the d3plot database. LS-PrePost always blindly labels this component as effective plastic strain. EQ.1: Effective strain EQ.2: Damage criterion threshold EQ.3: Damage (diso) EQ.4: Current damage criterion EQ.5: Pore water pressure EQ.6: Current friction angle (phi)
SPGRAV	Specific gravity of soil used to get porosity.
RHOWAT	Density of water in model units - used to determine air void strain (saturation)
VN	Viscoplasticity parameter (strain-rate enhanced strength)
GAMMAR	Viscoplasticity parameter (strain-rate enhanced strength)
ITERMX	Maximum number of plasticity iterations (default 1)
K	Bulk modulus (non-zero)
G	Shear modulus (non-zero)
PHIMAX	Peak shear strength angle (friction angle in radians)

VARIABLE	DESCRIPTION
AHYP	Coefficient A for modified Drucker-Prager Surface
COH	Cohesion \tilde{n} shear strength at zero confinement (overburden)
ECCEN	Eccentricity parameter for third invariant effects
AN	Strain hardening percent of PHIMAX where non-linear effects start
ET	Strain hardening amount of non-linear effects
MCONT	Moisture content of soil. It determines the amount of air voids and should be a value between 0.0 and 1.0.
PWD1	Parameter for pore water effects on bulk modulus
PWKSK	Skeleton bulk modulus. Pore water parameter, \tilde{n} , set to zero to eliminate effects.
PWD2	Parameter for pore water effects on the effective pressure (confinement)
PHIRES	The minimum internal friction angle in radians (residual shear strength)
DINT	Volumetric strain at initial damage threshold
VDFM	Void formation energy (like fracture energy)
DAMLEV	Level of damage that will cause element deletion (0.0 - 1.00)
EPSMAX	Maximum principle failure strain

***MAT_FHWA_SOIL_NEBRASKA**

This is an option to use the default properties determined for soils used at the University of Nebraska (Lincoln). The default units used for this material are millimeter, millisecond, and kilograms. If different units are desired, the conversion factors must be input.

This is Material Type 147. This is an isotropic material with damage and is available for solid elements. The model has a modified Mohr-Coulomb surface to determine the pressure dependent peak shear strength. It was developed for applications involving road base soils.

Card 1	1	2	3	4	5	6	7	8
Variable	MID	FCTIM	FCTMAS	FCTLEN				
Type	A	F	F	F				
Default	none	none	none	none				

VARIABLE**DESCRIPTION**

MID	Material identification. A unique number or label must be specified (see*PART).
FCTIM	Factor to multiply milliseconds by to get desired time units
FCTMAS	Factor to multiply kilograms by to get desired mass units
FCTLEN	Factor to multiply millimeters by to get desired length units

Remarks:

As an example, if units of seconds are desired for time, then $FCTIM = 0.001$.

*MAT_GAS_MIXTURE

This is Material Type 148. This model is for the simulation of thermally equilibrated ideal gas mixtures. This model only works with the multi-material ALE formulation (ELFORM = 11 in *SECTION_SOLID). This keyword must be used together with *INITIAL_GAS_MIXTURE for the initialization of gas densities and temperatures. When applied in the context of ALE airbag modeling, the injection of inflator gas is done with a *SECTION_POINT_SOURCE_MIXTURE command which controls the injection process. *MAT_ALE_GAS_MIXTURE (*MAT_ALE_02) is identical to this model and is another name for this material model.

Card Summary:

Card 1. This card is required.

MID	IADIAB	RUNIV					
-----	--------	-------	--	--	--	--	--

Card 2a.1. This card is included if and only if RUNIV is blank or zero.

CVmass1	CVmass2	CVmass3	CVmass4	CVmass5	CVmass6	CVmass7	CVmass8
---------	---------	---------	---------	---------	---------	---------	---------

Card 2a.2. This card is included if and only if RUNIV is blank or zero.

CPmass1	CPmass2	CPmass3	CPmass4	CPmass5	CPmass6	CPmass7	CPmass8
---------	---------	---------	---------	---------	---------	---------	---------

Card 2b.1. This card is included if and only if RUNIV is nonzero.

MOLWT1	MOLWT2	MOLWT3	MOLWT4	MOLWT5	MOLWT6	MOLWT7	MOLWT8
--------	--------	--------	--------	--------	--------	--------	--------

Card 2b.2. This card is included if and only if RUNIV is nonzero.

CPmole1	CPmole2	CPmole3	CPmole4	CPmole5	CPmole6	CPmole7	CPmole8
---------	---------	---------	---------	---------	---------	---------	---------

Card 2b.3. This card is included if and only if RUNIV is blank nonzero.

B1	B2	B3	B4	B5	B6	B7	B8
----	----	----	----	----	----	----	----

Card 2b.4. This card is included if and only if RUNIV is blank nonzero.

C1	C2	C3	C4	C5	C6	C7	C8
----	----	----	----	----	----	----	----

Data Card Definitions:

Card 1	1	2	3	4	5	6	7	8
Variable	MID	IADIAB	RUNIV					
Type	A	I	F					
Default	none	0	0.0					

VARIABLE**DESCRIPTION**

MID	Material identification. A unique number or label must be specified (see *PART).
IADIAB	This flag is used to turn ON/OFF adiabatic compression logics for an ideal gas. See Remark 5 . EQ.0: Off (default) EQ.1: On
RUNIV	Universal gas constant in per-mole unit (8.31447 J/(mole × K)). See Remark 1 .

Card 2 for Per Mass Calculation. Method (A) RUNIV = blank or 0.0.

Card 2a.1	1	2	3	4	5	6	7	8
Variable	CVmass1	CVmass2	CVmass3	CVmass4	CVmass5	CVmass6	CVmass7	CVmass8
Type	F	F	F	F	F	F	F	F

Card 3 for Per Mass Calculation. Method (A) RUNIV = blank or 0.0.

Card 2a.2	1	2	3	4	5	6	7	8
Variable	CPmass1	CPmass2	CPmass3	CPmass4	CPmass5	CPmass6	CPmass7	CPmass8
Type	F	F	F	F	F	F	F	F

VARIABLE	DESCRIPTION
CVmass1 - CVmass8	Heat capacity at constant volume for up to eight different gases in per-mass unit.
CPmass1 - CPmass8	Heat capacity at constant pressure for up to eight different gases in per-mass unit.

Card 2 for Per Mole Calculation. Method (B) RUNIV is nonzero.

Card 2b.1	1	2	3	4	5	6	7	8
Variable	MOLWT1	MOLWT2	MOLWT3	MOLWT4	MOLWT5	MOLWT6	MOLWT7	MOLWT8
Type	F	F	F	F	F	F	F	F

Card 3 for Per Mole Calculation. Method (B) RUNIV is nonzero.

Card 2b.2	1	2	3	4	5	6	7	8
Variable	CPmole1	CPmole2	CPmole3	CPmole4	CPmole5	CPmole6	CPmole7	CPmole8
Type	F	F	F	F	F	F	F	F

Card 4 for Per Mole Calculation. Method (B) RUNIV is nonzero.

Card 2b.3	1	2	3	4	5	6	7	8
Variable	B1	B2	B3	B4	B5	B6	B7	B8
Type	F	F	F	F	F	F	F	F

Card 5 for Per Mole Calculation. Method (B) RUNIV is nonzero.

Card 2b.4	1	2	3	4	5	6	7	8
Variable	C1	C2	C3	C4	C5	C6	C7	C8
Type	F	F	F	F	F	F	F	F

VARIABLE	DESCRIPTION
MOLWT1 - MOLWT8	Molecular weight of each ideal gas in the mixture (mass-unit/mole). See Remark 2 .
CPmole1 - CPmole8	Heat capacity at constant pressure for up to eight different gases in per-mole unit. These are nominal heat capacity values typically at STP. These are denoted by the variable A in the equation in Remark 2 .
B1 - B8	First order coefficient for a temperature dependent heat capacity at constant pressure for up to eight different gases. These are denoted by the variable B in the equation in Remark 2 .
C1 - C8	Second order coefficient for a temperature dependent heat capacity at constant pressure for up to eight different gases. These are denoted by the variable C in the equation in Remark 2 .

Remarks:

- Methods for Defining Gas Properties.** There are 2 methods of defining the gas properties for the mixture. If RUNIV is BLANK or ZERO, Method (A) is used to define constant heat capacities where per-mass unit values of C_v and C_p are input. Only Cards 2a.1 and 2a.2 are required for this method. Method (B) is used to define constant or temperature dependent heat capacities where per-mole unit values of C_p are input. Cards 2b.1 through 2b.4 are required for this method.
- Temperature Dependent Heat Capacity.** The per-mass-unit, temperature-dependent, constant-pressure heat capacity is

$$C_p(T) = \frac{[\text{CPmole} + B \times T + C \times T^2]}{\text{MOLWT}}$$

See [Table M148-1](#).

$C_p(T)$	CPmole	B	C
$\frac{\text{J}}{\text{kg K}}$	$\frac{\text{J}}{\text{mole K}}$	$\frac{\text{J}}{\text{mole K}^2}$	$\frac{\text{J}}{\text{mole K}^3}$

Table M148-1. Standard SI units

3. **Initial Temperature and Density.** The initial temperature and the density of the gas species present in a mesh or part at time zero is specified by the keyword *INITIAL_GAS_MIXTURE.
4. **Temperature and Energy Conservation.** The ideal gas mixture is assumed to be thermal equilibrium, that is, all species are at the same temperature (T). The gases in the mixture are also assumed to follow Dalton's Partial Pressure Law, $P = \sum_i^{\text{ngas}} P_i$. The partial pressure of each gas is then $P_i = \rho_i R_{\text{gas}_i} T$ where $R_{\text{gas}_i} = \frac{R_{\text{univ}}}{MW}$. The individual gas species temperature equals the mixture temperature. The temperature is computed from the internal energy where the *mixture internal energy per unit volume* is used,

$$e_V = \sum_i^{\text{ngas}} \rho_i C_{V_i} T_i = \sum_i^{\text{ngas}} \rho_i C_{V_i} T$$

$$T = T_i = \frac{e_V}{\sum_i^{\text{ngas}} \rho_i C_{V_i}}$$

In general, the advection step conserves *momentum* and *internal energy*, but not *kinetic energy*. This can result in energy lost in the system and lead to a pressure drop. In *MAT_GAS_MIXTURE the dissipated kinetic energy is automatically converted into heat (internal energy). Thus, in effect the total energy is conserved instead of conserving just the internal energy. This numerical scheme has been shown to improve accuracy in some cases. However, the user should always be vigilant and check the physics of the problem closely.

5. **IADIAB.** As an example, consider an airbag surrounded by ambient air. As the inflator gas flows into the bag, the ALE elements cut by the airbag fabric shell elements will contain some inflator gas inside and some ambient air outside. The multi-material element treatment is not perfect. Consequently the temperature of the outside air may be made artificially high after the multi-material element treatment. To prevent the outside ambient air from getting artificially high T , set IADIAB = 1 for the ambient air outside. A simple adiabatic compression equation is then assumed for the outside air. The use of this flag may be needed, but only when that air is modeled by the *MAT_GAS_MIXTURE card.

Example:

Consider a tank test model where the Lagrangian tank (Part S1) is surrounded by an ALE air mesh (Part H4 = AMMGID 1). There are 2 ALE parts which are defined but initially have no corresponding mesh: part 5 (H5 = AMMGID 2) is the resident gas inside the tank at $t = 0$, and part 6 (H6 = AMMGID 2) is the inflator gas(es) which is injected into the tank when $t > 0$. AMMGID stands for ALE Multi-Material Group ID. Please see the figure and input below. The *MAT_GAS_MIXTURE input defines the gas properties of

ALE parts H5 & H6. The *MAT_GAS_MIXTURE card input for both methods (A) and (B) are shown below.

The *INITIAL_GAS_MIXTURE keyword input is also shown below. It basically specifies that "AMMGID 2 may be present in part or mesh H4 at $t = 0$, and the initial density of this gas is defined in the rho1 position which corresponds to the 1st material in the mixture (or H5, the resident gas)."

Example Configuration:

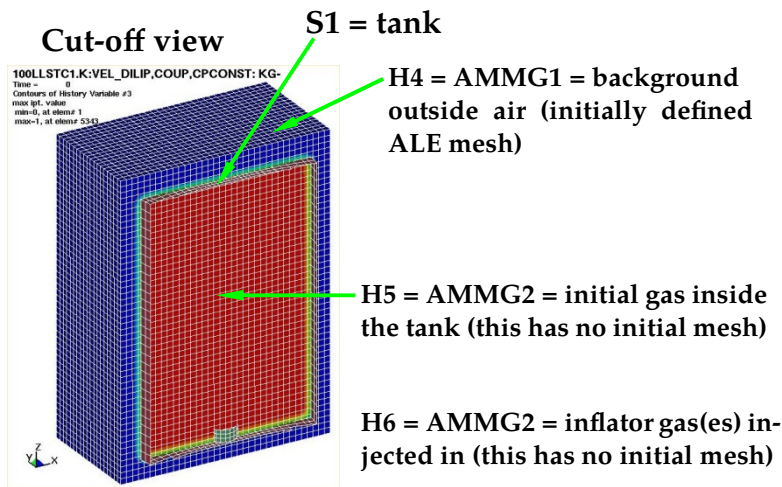

Sample Input:

```

$-----
*PART
H5 = initial gas inside the tank
$      PID      SECID      MID      EOSID      HGID      GRAV      ADPOPT      TMID
$      5         5         5         0           5         0           0
*SECTION_SOLID
$      5         11         0
$-----
$ Example 1: Constant heat capacities using per-mass unit.
$*MAT_GAS_MIXTURE
$      MID      IADIAB      R_univ
$      5         0           0
$      Cv1_mas  Cv2_mas  Cv3_mas  Cv4_mas  Cv5_mas  Cv6_mas  Cv7_mas  Cv8_mas
$718.7828911237.56228
$      Cp1_mas  Cp2_mas  Cp3_mas  Cp4_mas  Cp5_mas  Cp6_mas  Cp7_mas  Cp8_mas
$1007.00058 1606.1117
$-----
$ Example 2: Variable heat capacities using per-mole unit.
$*MAT_GAS_MIXTURE
$      MID      IADIAB      R_univ
$      5         0      8.314470
$      MW1      MW2      MW3      MW4      MW5      MW6      MW7      MW8
$      0.0288479 0.02256
$      Cp1_mol  Cp2_mol  Cp3_mol  Cp4_mol  Cp5_mol  Cp6_mol  Cp7_mol  Cp8_mol
$      29.049852 36.23388
$      B1         B2         B3         B4         B5         B6         B7         B8

```



```
7.056E-3 0.132E-1
$      C1      C2      C3      C4      C5      C6      C7      C8
-1.225E-6 -0.190E-5
-----
$ One card is defined for each AMMG that will occupy some elements of a mesh set
*INITIAL_GAS_MIXTURE
$      SID      STYPE      MMGID      T0
      4      1      1      298.15
$      RHO1      RHO2      RHO3      RHO4      RHO5      RHO6      RHO7      RHO8
1.17913E-9
*INITIAL_GAS_MIXTURE
$      SID      STYPE      MMGID      T0
      4      1      2      298.15
$      RHO1      RHO2      RHO3      RHO4      RHO5      RHO6      RHO7      RHO8
1.17913E-9
-----
```

***MAT_EMMI**

This is Material Type 151. The Evolving Microstructural Model of Inelasticity (EMMI) is a temperature and rate-dependent state variable model developed to represent the large deformation of metals under diverse loading conditions [Marin et al. 2006]. It includes various state variables to characterize effects of microstructural features, such as dislocation creation or annihilation. This model is available for 3D solid elements, 2D solid elements and thick shell forms 3 and 5.

Card Summary:

Card 1. This card is required.

MID	RHO	E	PR				
-----	-----	---	----	--	--	--	--

Card 2. This card is required.

RGAS	BVECT	D0	QD	CV	ADRAG	BDRAG	DMTHTA
------	-------	----	----	----	-------	-------	--------

Card 3. This card is required.

DMPHI	DNTHTA	DNPHI	THETA0	THETAM	BETA0	BTHETA	DMR
-------	--------	-------	--------	--------	-------	--------	-----

Card 4. This card is required.

DNUC1	DNUC2	DNUC3	DNUC4	DM1	DM2	DM3	DM4
-------	-------	-------	-------	-----	-----	-----	-----

Card 5. This card is required.

DM5	Q1ND	Q2ND	Q3ND	Q4ND	CALPHA	CKAPPA	C1
-----	------	------	------	------	--------	--------	----

Card 6. This card is required.

C2ND	C3	C4	C5	C6	C7ND	C8ND	C9ND
------	----	----	----	----	------	------	------

Card 7. This card is required.

C10	A1	A2	A3	A4	A_XX	A_YY	A_ZZ
-----	----	----	----	----	------	------	------

Card 8. This card is required.

A_XY	A_YZ	A_XZ	ALPHXX	ALPHY	ALPHZZ	ALPHXY	ALPHYZ
------	------	------	--------	-------	--------	--------	--------

Card 9. This card is required.

ALPHXZ	DKAPPA	PHI0	PHICR	DLBDAG	FACTOR	RSWTCH	DMGOPT
--------	--------	------	-------	--------	--------	--------	--------

Card 10. This card is required.

DELASO	DIMPLO	ATOL	RTOL	DINTER			
--------	--------	------	------	--------	--	--	--

Card 11. This card is required. *Leave this card blank.*

--	--	--	--	--	--	--	--

Data Card Definitions:

Card 1	1	2	3	4	5	6	7	8
Variable	MID	RHO	E	PR				
Type	A	F	F	F				

VARIABLE

DESCRIPTION

MID	Material identification. A unique number or label must be specified (see *PART).
RHO	Material density
E	Young's modulus
PR	Poisson's ratio

Card 2	1	2	3	4	5	6	7	8
Variable	RGAS	BVECT	D0	QD	CV	ADRAG	BDRAG	DMTHTA
Type	F	F	F	F	F	F	F	F

VARIABLE

DESCRIPTION

RGAS	Universal gas constant
BVECT	Burger's vector
D0	Pre-exponential diffusivity coefficient
QD	Activation energy

VARIABLE	DESCRIPTION
-----------------	--------------------

CV	Specific heat at constant volume
ADRAG	Drag intercept
BDRAG	Drag coefficient
DMTHTA	Shear modulus temperature coefficient

Card 3	1	2	3	4	5	6	7	8
Variable	DMPHI	DNTHTA	DNPHI	THETA0	THETAM	BETA0	BTHETA	DMR
Type	F	F	F	F	F	F	F	F

VARIABLE	DESCRIPTION
-----------------	--------------------

DMPHI	Shear modulus damage coefficient
DNTHTA	Bulk modulus temperature coefficient
DNPHI	Bulk modulus damage coefficient
THETA0	Reference temperature
THETAM	Melt temperature
BETA0	Coefficient of thermal expansion at reference temperature
BTHETA	Thermal expansion temperature coefficient
DMR	Damage rate sensitivity parameter

Card 4	1	2	3	4	5	6	7	8
Variable	DNUC1	DNUC2	DNUC3	DNUC4	DM1	DM2	DM3	DM4
Type	F	F	F	F	F	F	F	F

VARIABLE	DESCRIPTION
-----------------	--------------------

DNUC1	Nucleation coefficient 1
-------	--------------------------

VARIABLE	DESCRIPTION
DNUC2	Nucleation coefficient 2
DNUC3	Nucleation coefficient 3
DNUC4	Nucleation coefficient 4
DM1	Coefficient of yield temperature dependence
DM2	Coefficient of yield temperature dependence
DM3	Coefficient of yield temperature dependence
DM4	Coefficient of yield temperature dependence

Card 5	1	2	3	4	5	6	7	8
Variable	DM5	Q1ND	Q2ND	Q3ND	Q4ND	CALPHA	CKAPPA	C1
Type	F	F	F	F	F	F	F	F

VARIABLE	DESCRIPTION
DM5	Coefficient of yield temperature dependence
Q1ND	Dimensionless activation energy, Q_1 , for f
Q2ND	Dimensionless activation energy, Q_2 , for r_d
Q3ND	Dimensionless activation energy, Q_3 , for R_d
Q4ND	Dimensionless activation energy, Q_4 , for R_s
CALPHA	Coefficient for backstress, α
CKAPPA	Coefficient for internal stress, κ
C1	Parameter, c_1 , for flow rule exponent, n

Card 6	1	2	3	4	5	6	7	8
Variable	C2ND	C3	C4	C5	C6	C7ND	C8ND	C9ND
Type	F	F	F	F	F	F	F	F

VARIABLE**DESCRIPTION**

C2ND	Parameter, c_2 , for transition rate f
C3	Parameter, c_3 , for alpha dynamic recovery, r_d
C4	Parameter, c_4 , for alpha hardening, h
C5	Parameter, c_5 , for kappa dynamic recovery, R_d
C6	Parameter, c_6 , for kappa hardening, H
C7ND	Parameter, c_7 , kappa static recovery, R_s
C8ND	Parameter, c_8 , for yield
C9ND	Parameter, c_9 , for temperature dependence of flow rule exponent, n

Card 7	1	2	3	4	5	6	7	8
Variable	C10	A1	A2	A3	A4	A_XX	A_YY	A_ZZ
Type	F	F	F	F	F	F	F	F

VARIABLE**DESCRIPTION**

C10	Parameter, c_{10} , for static recovery (set to 1)
A1	Plastic anisotropy parameter
A2	Plastic anisotropy parameter
A3	Plastic anisotropy parameter
A4	Plastic anisotropy parameter
A_XX	Initial structure tensor component

VARIABLE	DESCRIPTION
-----------------	--------------------

A_YY Initial structure tensor component

A_ZZ Initial structure tensor component

Card 8	1	2	3	4	5	6	7	8
Variable	A_XY	A_YZ	A_XZ	ALPHXX	ALPHYY	ALPHZZ	ALPHXY	ALPHYZ
Type	F	F	F	F	F	F	F	F

VARIABLE	DESCRIPTION
-----------------	--------------------

A_XY Initial structure tensor component

A_YZ Initial structure tensor component

A_XZ Initial structure tensor component

ALPHXX Initial backstress component

ALPHYY Initial backstress component

ALPHZZ Initial backstress component

ALPHXY Initial backstress component

ALPHYZ Initial backstress component

Card 9	1	2	3	4	5	6	7	8
Variable	ALPHXZ	DKAPPA	PHI0	PHICR	DLBDAG	FACTOR	RSWTCH	DMGOPT
Type	F	F	F	F	F	F	F	F

VARIABLE	DESCRIPTION
-----------------	--------------------

ALPHXZ Initial backstress component

DKAPPA Initial isotropic internal stress

PHI0 Initial isotropic porosity

VARIABLE	DESCRIPTION
PHICR	Critical cutoff porosity
DLBDAG	Slip system geometry parameter
FACTOR	Fraction of plastic work converted to heat, adiabatic
RSWTCH	Rate sensitivity switch
DMGOPT	Damage model option parameter: EQ.1.0: Pressure independent Cocks/ Ashby 1980 EQ.2.0: Pressure dependent Cocks/ Ashby 1980 EQ.3.0: Pressure dependent Cocks 1989

Card 10	1	2	3	4	5	6	7	8
Variable	DELASO	DIMPLO	ATOL	RTOL	DINTER			
Type	F	F	F	F	F			

VARIABLE	DESCRIPTION
DELASO	Temperature option: EQ.0.0: Driven externally EQ.1.0: Adiabatic
DIMPLO	Implementation option flag: EQ.1.0: Combined viscous drag and thermally activated dislocation motion EQ.2.0: Separate viscous drag and thermally activated dislocation motion
ATOL	Absolute error tolerance for local Newton iteration
RTOL	Relative error tolerance for local Newton iteration
DNITER	Maximum number of iterations for local Newton iteration

Leave this card blank (but include it!).

Card 11	1	2	3	4	5	6	7	8
Variable								
Type								

Remarks:

1. **EMMI Plasticity Model.** The following equations summarize the evolution equations and material functions for the EMMI model. See [Marin et al 2006] for more details.

$$\dot{\alpha} = h \mathbf{d}^p - r_d \dot{\epsilon}^p \bar{\alpha} \alpha$$

$$\dot{\kappa} = (H - R_d \kappa) \dot{\epsilon}^p - R_s \kappa \sinh(Q_s \kappa)$$

$$\mathbf{d}^p = \sqrt{\frac{3}{2}} \dot{\epsilon}^p \mathbf{n}, \dot{\epsilon}^p = f \sinh^n \left[\left\langle \frac{\bar{\sigma}}{\kappa + Y} - 1 \right\rangle \right]$$

$\dot{\epsilon}^p$ – equation	α – equation	κ – equation
$f = c_2 \exp\left(\frac{Q_1}{\theta}\right)$	$r_d = c_3 \exp\left(\frac{-Q_2}{\theta}\right)$	$R_d = c_5 \exp\left(\frac{-Q_3}{\theta}\right)$
$n = \frac{c_9}{\theta} - c_1$	$h = c_4 \hat{\mu}(\theta)$	$H = c_6 \hat{\mu}(\theta)$
$Y = c_8 \hat{Y}(\theta)$		$R_s = c_7 \exp\left(\frac{-Q_4}{\theta}\right)$
		$Q_s = c_{10} \exp\left(\frac{-Q_5}{\theta}\right)$

Table M151-1. Plasticity Material Functions of EMMI Model.

2. **Void Growth.** The following equations extend the EMMI material model for void growth. See [Marin et al 2006] for more details

$$\dot{\phi} = \frac{3}{\sqrt{2}} (1 - \phi) \hat{G}(\bar{\sigma}_{eq}, \bar{p}, \phi) \dot{\epsilon}^p$$

$$\hat{G}(\bar{\sigma}_{eq}, \bar{p}, \phi) = \frac{3}{\sqrt{3}} \left[\frac{1}{(1 - \phi)m + 1} - 1 \right] \sinh \left[\frac{2(2m - 1) \langle \bar{p} \rangle}{2m + 1 \bar{\sigma}_{eq}} \right]$$

***MAT_DAMAGE_3**

This is Material Type 153. This model has up to 10 back stress terms for kinematic hardening combined with isotropic hardening and a damage model for modeling low cycle fatigue and failure. The model is based on Huang [2009]. It is available for solid, shell, thick shell, and beam elements. This model is supported for both explicit and implicit analysis. For beams the model is restricted to 3 back stress terms, temperature independent data and KHFLG = 0; while for solids, shells, and thick shells up to 10 back stress terms can be used, including temperature effects and parameter fit from uniaxial cyclic stress-strain tests (KHFLG > 0).

Card Summary:

Card 1. This card is required.

MID	RO	E	PR	SIGY	HARDI	BETA	LCSS
-----	----	---	----	------	-------	------	------

Card 2. This card is required.

HARDK1	GAMMA1	HARDK2	GAMMA2	SRC	SRP	HARDK3	GAMMA3
--------	--------	--------	--------	-----	-----	--------	--------

Card 3. This card is required.

IDAM	IDS	IDEP	EPSD	S	T	DC	KHFLG
------	-----	------	------	---	---	----	-------

Card 4a. This card is only read when KHFLG = 0. It is optional.

HARDK4	GAMMA4						
--------	--------	--	--	--	--	--	--

Card 4b. This card is included if KHFLG > 0.

LCKH	NKH						
------	-----	--	--	--	--	--	--

Data Card Definitions:

Card 1	1	2	3	4	5	6	7	8
Variable	MID	RO	E	PR	SIGY	HARDI	BETA	LCSS
Type	A	F	F	F	F	F	F	I

VARIABLE	DESCRIPTION
MID	Material identification. A unique number or label must be specified (see *PART).
RO	Mass density, ρ
E	Young's modulus, E LT.0: -E gives the curve ID for E as a function of temperature.
PR	Poisson's ratio, ν LT.0: -PR gives the curve ID for ν as a function of temperature.
SIGY	Initial yield stress, σ_{y0} (ignored if LCSS > 0)
HARDI	Isotropic hardening modulus, H (ignored if LCSS > 0)
BETA	Isotropic hardening parameter, β . Set $\beta = 0$ for linear isotropic hardening. (Ignored if LCSS > 0 or if HARDI = 0.)
LCSS	Load curve or table ID defining effective stress as a function of effective plastic strain (and temperature in the table case) for isotropic hardening. For a table each curve corresponds to a temperature. The first abscissa value (effective plastic strain) in each curve must be zero corresponding to the initial yield stress. The first ordinate value in each curve is the initial yield stress.

Card 2	1	2	3	4	5	6	7	8
Variable	HARDK1	GAMMA1	HARDK2	GAMMA2	SRC	SRP	HARDK3	GAMMA3
Type	F	F	F	F	F	F	F	F

VARIABLE	DESCRIPTION
HARDK _j	Kinematic hardening modulus, C_j LT.0: -HARDK _j gives the curve ID for C_j as a function of temperature.
GAMMA _j	Kinematic hardening parameter, γ_j . Set $\gamma_j = 0$ for linear kinematic hardening. Ignored if HARDK _j = 0.

VARIABLE	DESCRIPTION
----------	-------------

	LT.0: -GAMMAj gives the curve ID for γ_j as a function of temperature.
SRC	Strain rate parameter, C , for Cowper Symonds strain rate model; see remarks below. If zero, rate effects are not considered. LT.0: -SRC gives the curve ID for C as a function of temperature.
SRP	Strain rate parameter, p , for Cowper Symonds strain rate model; see remarks below. If zero, rate effects are not considered. LT.0: -SRP gives the curve ID for p as a function of temperature.

Card 3	1	2	3	4	5	6	7	8
Variable	IDAM	IDS	IDEP	EPSD	S	T	DC	KHFLG
Type	I	I	I	F	F	F	F	I

VARIABLE	DESCRIPTION
----------	-------------

IDAM	Isotropic damage flag: EQ.0: Damage is inactivated. IDS, IDEP, EPSD, S, T, and DC are ignored. EQ.1: Damage is activated.
IDS	Output stress flag: EQ.0: Undamaged stress, $\tilde{\sigma}$, is output. EQ.1: Damaged stress, $\tilde{\sigma}(1 - D)$, is output.
IDEP	Damaged plastic strain: EQ.0: Plastic strain is accumulated, $r = \int \dot{\epsilon}^{pl}$. EQ.1: Damaged plastic strain is accumulated, $r = \int (1 - D)\dot{\epsilon}^{pl}$.
EPSD	Damage threshold, r_d . Damage accumulation begins when $r > r_d$.
S	Damage material constant, S . Default = $\sigma_{y0}/200$.
T	Damage material constant, t . Default = 1.

VARIABLE	DESCRIPTION
DC	Critical damage value, D_c . When damage value reaches the critical value, the element is deleted from calculation. Default = 0.5.
KHFLG	<p>Kinematic hardening flag:</p> <p>EQ.0: Use kinematic hardening parameters HARDKj and GAMMAj (default).</p> <p>EQ.1: Kinematic hardening parameters (C_j, γ_j) given by load curve or table if temperature is considered. NKH data points used (with a maximum of 10) in each curve. HARDKj and GAMMAj fields are ignored.</p> <p>EQ.2: Fits NKH kinematic hardening parameters (C_j, γ_j) to uniaxial stress-strain data at constant temperature for a half-cycle, meaning it fits</p> $\sigma_i = \sigma_y(\varepsilon_i^p) + \sum_{j=1}^{NKH} \frac{C_j}{\gamma_j} (1 - \exp(-\gamma_j \varepsilon_i^p))$ <p>to stress as a function of plastic strain data. The stress, σ_i, can be given in field LCKH as a function of strain, ε_i^p, in a load curve or as a function of strain and temperature, T, in a table. HARDKj and GAMMAj fields are ignored.</p> <p>EQ.3: Fits NKH kinematic hardening parameters (C_j, γ_j) to uniaxial stress-strain data for the tensile part of a stabilized cycle, meaning it fits</p> $\sigma_i = \frac{\sigma_1 + \sigma_N}{2} + \sum_{j=1}^{NKH} \frac{C_j}{\gamma_j} (1 - 2 \exp(-\gamma_j \varepsilon_i^p))$ <p>to N stress as a function of plastic strain data. This data is given by LCKH as either a load curve or table depending on if temperature is included. Here the first data point is chosen such that $\varepsilon_1^p = 0$. HARDKj and GAMMAj fields are ignored.</p>

VARIABLE	DESCRIPTION
-----------------	--------------------

EQ.4: Fits NKH kinematic hardening parameters (C_j, γ_j) to uni-axial stress-strain data for different stabilized cycles, that is, it fits

$$\sigma_i = \sigma_y(\epsilon_i^p) + \sum_{j=1}^{NKH} \frac{C_j}{\gamma_j} \tanh(\gamma_j \epsilon_i^p),$$

to max stress as a function of max plastic strain data over N cycles. This data is given by LCKH as either a load curve or table depending on if temperature is defined. HARDKj and GAMMAj fields are ignored.

Optional Card 4 (read only if KHFLG = 0)

Card 4a	1	2	3	4	5	6	7	8
Variable	HARDK4	GAMMA4						
Type	F	F						

VARIABLE	DESCRIPTION
-----------------	--------------------

HARDK4 Kinematic hardening modulus, C_4
 LT.0: -HARDK4 gives the curve ID for C_4 as a function of temperature.

GAMMA4 Kinematic hardening parameter, γ_4 . Set $\gamma_4 = 0$ for linear kinematic hardening. Ignored if HARDK4 = 0.
 LT.0: -GAMMA4 gives the curve ID for γ_4 as a function of temperature.

Card 4 (included if and only if KHFLG > 0)

Card 4b	1	2	3	4	5	6	7	8
Variable	LCKH	NKH						
Type	I	I						

VARIABLE	DESCRIPTION
LCKH	Load curve or table ID defining kinematic hardening when KHFLG > 0. A table is used when temperature dependence is considered. Depending on KHFLG, it gives either (C_j, γ_j) values or stress as a function of plastic strain with optional temperature dependence.
NKH	Number of kinematic hardening parameters when KHFLG > 0. Up to 10 back stresses can be used.

Model Description:

This model is based on the work of Lemaitre [1992], and Dufailly and Lemaitre [1995]. It is a pressure-independent plasticity model with the yield surface defined by the function

$$F = \bar{\sigma} - \sigma_y = 0 ,$$

where σ_y is uniaxial yield stress,

$$\sigma_y = \sigma_{y0} + \frac{H}{\beta} [1 - \exp(-\beta r)] .$$

By setting $\beta = 0$, a linear isotropic hardening is obtained

$$\sigma_y = \sigma_{y0} + Hr ,$$

where σ_{y0} is the initial yield stress. In the above, $\bar{\sigma}$ is the equivalent von Mises stress, with respect to the deviatoric effective stress,

$$s_e = \text{dev}[\tilde{\sigma}] - \alpha = \mathbf{s} - \alpha .$$

Here \mathbf{s} is deviatoric stress and α is the back stress, which is the sum of up to four terms according to:

$$\alpha = \sum_j \alpha_j .$$

$\tilde{\sigma}$ is effective stress (undamaged stress), based on Continuum Damage Mechanics model [Lemaitre 1992],

$$\tilde{\sigma} = \frac{\sigma}{1 - D} .$$

Here D is the isotropic damage scalar, which is bounded by 0 and 1

$$0 \leq D \leq 1 .$$

$D = 0$ represents a damage-free material RVE (representative volume element), while $D = 1$ represents a fully broken material RVE in two parts. In fact, fracture occurs when $D = D_c < 1$, modeled as element removal. The evolution of the isotropic damage value related to ductile damage and fracture (the case where the plastic strain or dissipation is much larger than the elastic one, [Lemaitre 1992]) is defined as

$$\dot{D} = \begin{cases} \left(\frac{Y}{S}\right)^t \dot{\tilde{\epsilon}}^{pl} & \text{when } r > r_d \text{ and } \frac{\sigma_m}{\sigma_{eq}} > -\frac{1}{3} \\ 0 & \text{otherwise} \end{cases}$$

where σ_m/σ_{eq} is the stress triaxiality, r_d is damage threshold, S is a material constant, and Y is strain energy density release rate:

$$Y = \frac{1}{2} \boldsymbol{\epsilon}^{el} : \mathbf{D}^{el} : \boldsymbol{\epsilon}^{el} .$$

Here \mathbf{D}^{el} represents the fourth-order elasticity tensor and $\boldsymbol{\epsilon}^{el}$ is elastic strain. In the above, t is a material constant, introduced by Dufailly and Lemaitre [1995], to provide an additional degree of freedom for modeling low-cycle fatigue ($t = 1$ in Lemaitre [1992]). Dufailly and Lemaitre [1995] also proposed a simplified method to fit experimental results and get S and t .

The equivalent Mises stress is defined as

$$\bar{\sigma}(\mathbf{s}_e) = \sqrt{\frac{3}{2} \mathbf{s}_e : \mathbf{s}_e} = \sqrt{\frac{3}{2}} \|\mathbf{s}_e\| .$$

The model assumes associated plastic flow

$$\dot{\boldsymbol{\epsilon}}^{pl} = \frac{\partial F}{\partial \boldsymbol{\sigma}} d\lambda = \frac{3 \mathbf{s}_e}{2 \bar{\sigma}} d\lambda ,$$

where $d\lambda$ is the plastic consistency parameter. The evolution of the kinematic component of the model is defined as [Armstrong and Frederick 1966]:

$$\dot{\boldsymbol{\alpha}}_j = \begin{cases} \frac{2}{3} C_j \dot{\boldsymbol{\epsilon}}^{pl} - \gamma_j \boldsymbol{\alpha}_j \dot{\tilde{\epsilon}}^{pl} & \text{if IDEP} = 0 \\ (1 - D) \left(\frac{2}{3} C_j \dot{\boldsymbol{\epsilon}}^{pl} - \gamma_j \boldsymbol{\alpha}_j \dot{\tilde{\epsilon}}^{pl} \right) & \text{if IDEP} = 1 \end{cases}$$

The damaged plastic strain is accumulated as

$$r = \begin{cases} \int \dot{\tilde{\epsilon}}^{pl} & \text{if IDEP} = 0 \\ \int (1 - D) \dot{\tilde{\epsilon}}^{pl} & \text{if IDEP} = 1 \end{cases}$$

where $\dot{\tilde{\epsilon}}^{pl}$ is the equivalent plastic strain rate

$$\dot{\tilde{\epsilon}}^{pl} = \sqrt{\frac{2}{3} \dot{\boldsymbol{\epsilon}}^{pl} : \dot{\boldsymbol{\epsilon}}^{pl}} .$$

$\dot{\boldsymbol{\epsilon}}^{pl}$ represents the rate of plastic flow.

Strain rate is accounted for using the Cowper and Symonds model which scales the yield stress with the factor

$$1 + \left(\frac{\dot{\epsilon}}{C}\right)^{1/p}$$

where $\dot{\epsilon}$ is the strain rate.

Uniaxial cyclic tension and compression:

This material can be used to model cyclic hardening plasticity, including effects known as *plastic shakedown* and *strain ratcheting*. To understand how the plasticity parameters qualitatively influence the behavior in uniaxial tension and compression, we restrict ourselves to a discussion concerning linear isotropic hardening with initial yield σ_Y and hardening modulus H . We also only include two kinematic hardening terms. For the kinematic part, we use one linear term with hardening C_0 (and decay coefficient $\gamma_0 = 0$) and one combined term with hardening C and decay coefficient γ . The elastic Young's modulus is denoted E , and we neglect any forms of temperature or rate effects.

While this is merely an attempt to explain the phenomena, estimating the parameters that reflect the actual behavior of the physical material may be difficult. Because of this, we recommend the fitting options provided by KHFLG, where even the effects of temperature can be accounted for.

Strain induced deformation

Consider the cyclic deformation depicted in [Figure M153-1](#) in which the uniaxial strain ranges between $\underline{\epsilon}$ and $\bar{\epsilon}$. Two subsequent stress-strain cycles are shown.

If the isotropic hardening modulus $H = 0$, then the cycles are identical. For nonzero hardening H , the stress level increases with each cycle and the strain width indicated by $\bar{\epsilon}$ decreases. As the yield surface expands, the isotropic hardening effect diminishes, and we tend towards a stable cycle; this phenomenon is called *plastic shakedown*.

If both H and C_0 are zero, then the end of each cycle tends towards ideal plastic since the presence of a nonzero γ saturates the level of back stress and consequently the stress σ itself. This physical phenomenon is unlikely. Therefore, we recommend having at least one linear kinematic hardening term present in combination with some isotropic hardening for a realistic behavior.

Stress induced deformation

For stress induced deformation, we impose a cyclic stress between $\underline{\sigma}$ and $\bar{\sigma}$ as shown in [Figure M153-2](#) and investigate two subsequent stress-strain cycles. In this case a combination of isotropic hardening and nonlinear kinematic hardening may cause a drift in strain. This drift is referred to as *ratcheting strain* and may be considered a creep phenomenon. Even without the isotropic hardening H , a nonzero mean stress, $(\bar{\sigma} + \underline{\sigma})/2$, in the

cycle causes a ratcheting effect. We again recommend using combinations of isotropic, linear and nonlinear kinematic hardening for accurate predictions of this creep behavior.

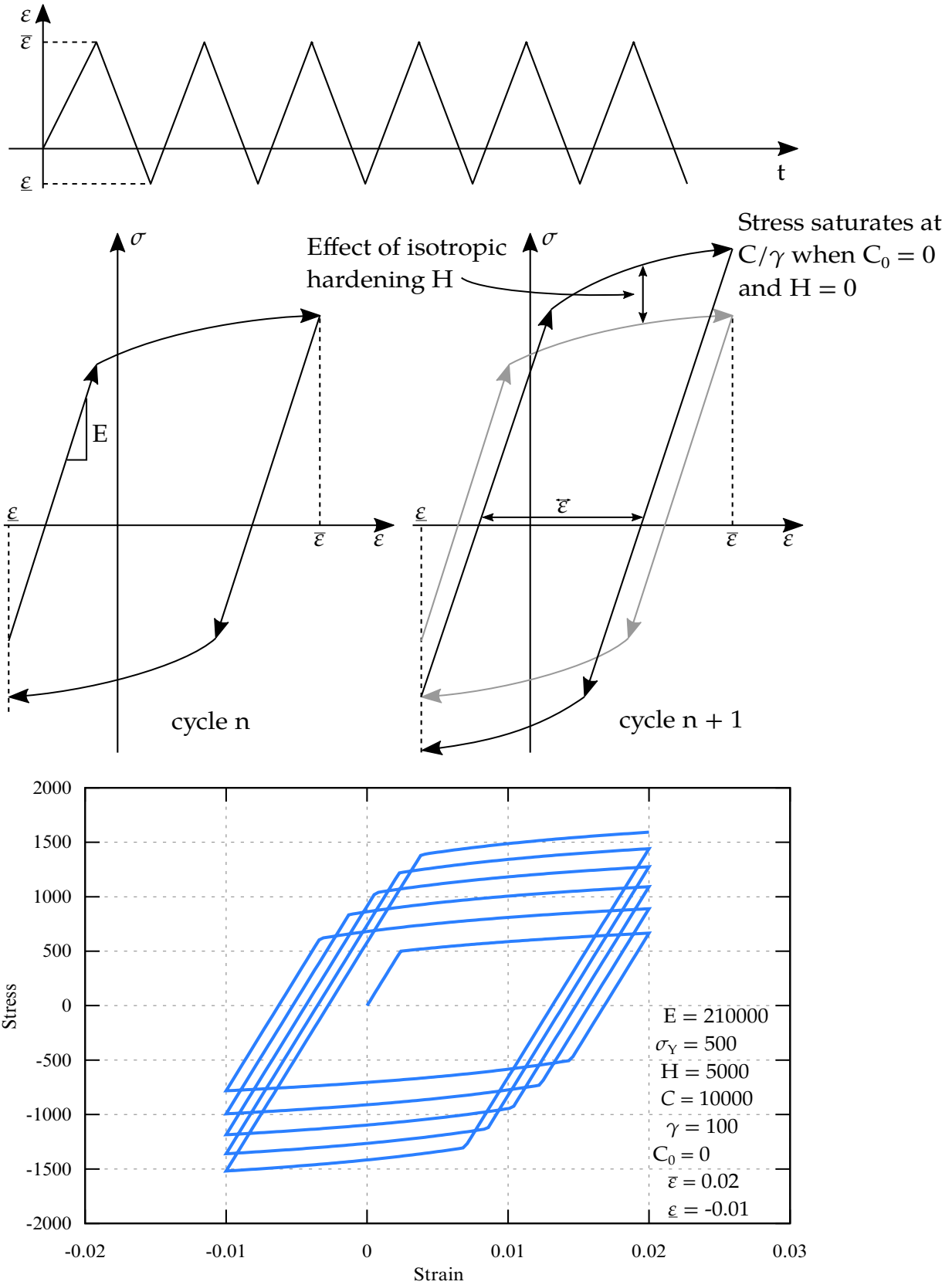

Figure M153-1. Schematic of Uniaxial Plastic Shakedown Phenomenon

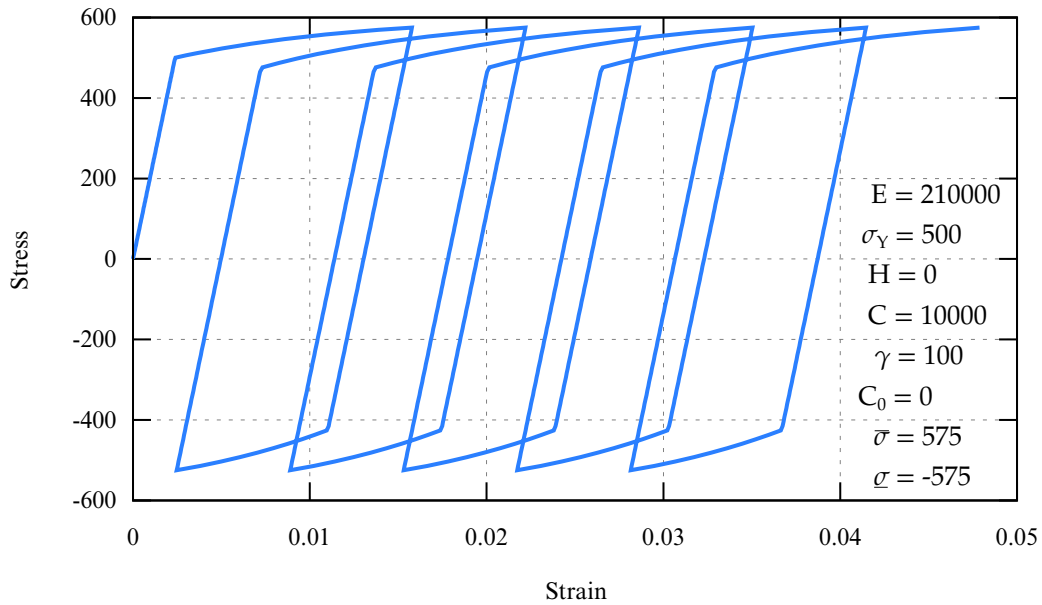
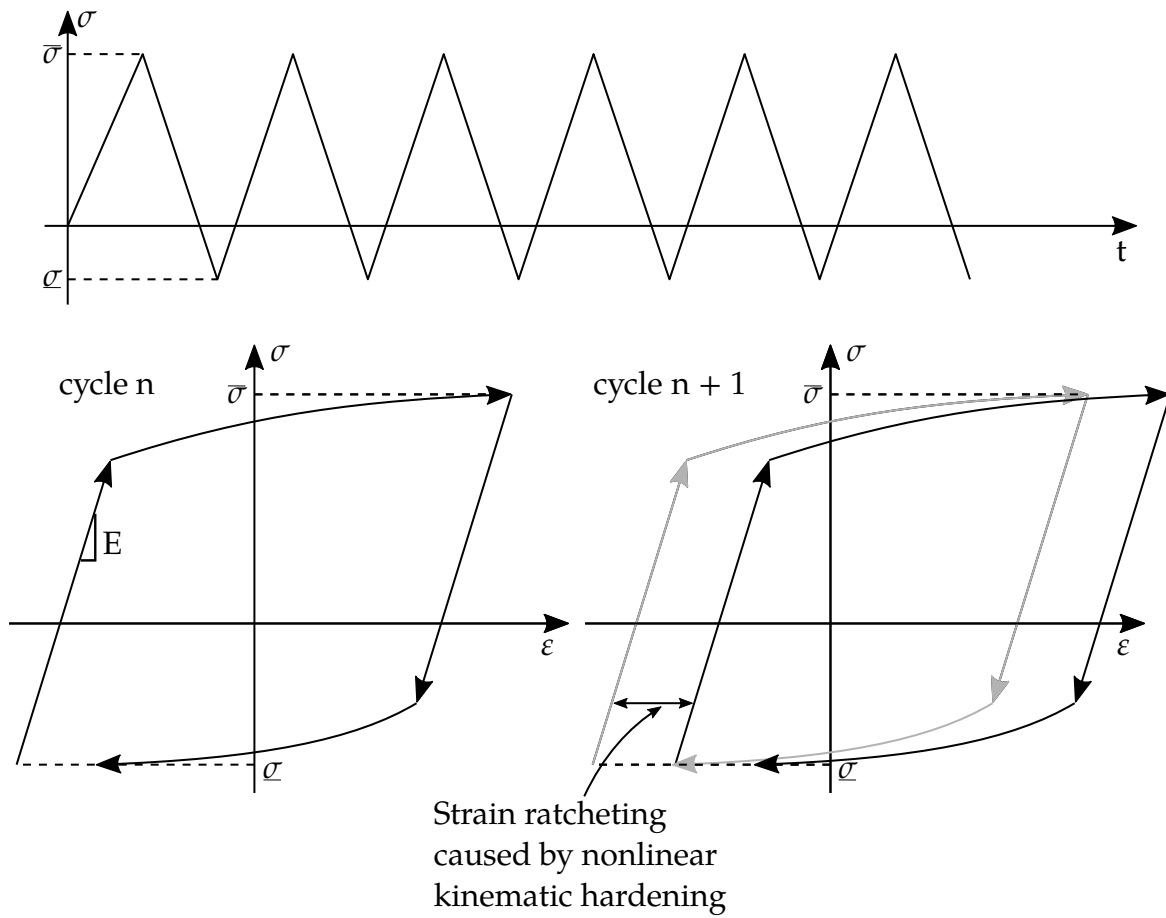

Figure M153-2. Schematic of Uniaxial Strain Ratcheting Phenomenon

Material Model Comparison:

Table M153-1 below shows the difference between MAT 153 (for KHFLG = 0) and MAT 104/105. MAT 153 is less computationally expensive than MAT 104/105. Kinematic hardening, which already exists in MAT 103, is included in MAT 153 but not in MAT 104/105.

	MAT 153	MAT 104	MAT 105
Computational cost	1.0	3.0	3.0
Isotropic hardening	One component	Two components	One component
Kinematic hardening	Four components	N/A	N/A
Output stress	IDS = 0 $\Rightarrow \tilde{\sigma}$ IDS = 1 $\Rightarrow \tilde{\sigma}(1 - D)$	$\tilde{\sigma}(1 - D)$	$\tilde{\sigma}(1 - D)$
Damaged plastic strain	IDEP = 0 \Rightarrow $r = \int \dot{\tilde{\epsilon}}^{Pl}$ IDEP = 1 \Rightarrow $r = \int (1 - D) \dot{\tilde{\epsilon}}^{Pl}$	$r = \int (1 - D) \dot{\tilde{\epsilon}}^{Pl}$	$r = \int (1 - D) \dot{\tilde{\epsilon}}^{Pl}$
Accumulation when	$\frac{\sigma_m}{\sigma_{eq}} > -\frac{1}{3}$	$\sigma_1 > 0$	$\sigma_1 > 0$
Isotropic plasticity	Yes	Yes	Yes
Anisotropic plasticity	No	Yes	No
Isotropic damage	Yes	Yes	Yes
Anisotropic damage	No	Yes	No

Table M153-1. Differences between MAT 153 and MAT 104/105

History Variables:

Additional history variables, which can be written by using variables NEIPH and NEIPS in *DATABASE_EXTENT_BINARY, are as follows:

History Variable #	Description
1	Damage, D

History Variable #	Description
2	Back stress term 1 in the 11-direction
3	Back stress term 1 in the 22-direction
4	Back stress term 1 in the 12-direction
5	Back stress term 1 in the 23-direction
6	Back stress term 1 in the 31-direction
7	Back stress term 2 in the 11-direction
8	Back stress term 2 in the 22-direction
9	Back stress term 2 in the 12-direction
10	Back stress term 2 in the 23-direction
11	Back stress term 2 in the 31-direction
12	Back stress term 3 in the 11-direction
13	Back stress term 3 in the 22-direction
14	Back stress term 3 in the 12-direction
15	Back stress term 3 in the 23-direction
16	Back stress term 3 in the 31-direction
17	Back stress term 4 in the 11-direction
18	Back stress term 4 in the 22-direction
19	Back stress term 4 in the 12-direction
20	Back stress term 4 in the 23-direction
21	Back stress term 4 in the 31-direction

***MAT_DESHPANDE_FLECK_FOAM**

This is Material Type 154 for solid elements. This material is for modeling aluminum foam used as a filler material in aluminum extrusions to enhance the energy absorbing capability of the extrusion. Such energy absorbers are used in vehicles to dissipate energy during impact. This model was developed by Reyes, Hopperstad, Berstad, and Langseth [2002] and is based on the foam model by Deshpande and Fleck [2000].

Card 1	1	2	3	4	5	6	7	8
Variable	MID	RHO	E	PR	ALPHA	GAMMA		
Type	A	F	F	F	F	F		
Default	none	none	none	none	none	none		

Card 2	1	2	3	4	5	6	7	8
Variable	EPSD	ALPHA2	BETA	SIGP	DERFI	CFAIL	PFAIL	NUM
Type	F	F	F	F	F	F	F	I
Default	none	none	none	none	none	↓	↓	1000

VARIABLE**DESCRIPTION**

MID	Material identification. A unique number or label must be specified (see *PART).
RHO	Mass density
E	Young's modulus
PR	Poisson's ratio
ALPHA	Controls shape of yield surface
GAMMA	Material parameter, γ ; see Remarks.
EPSD	Densification strain

VARIABLE	DESCRIPTION
ALPHA2	Material parameter, α_2 ; see Remarks.
BETA	Material parameter, β ; see Remarks.
SIGP	Material parameter, σ_p ; see Remarks.
DERFI	Type of derivation used in material subroutine: EQ.0: Numerical derivation EQ.1: Analytical derivation
CFAIL	Tensile volumetric strain at failure. Default is no failure due to tensile volumetric strain.
PFAIL	Maximum principal stress at failure. Must be sustained NUM (> 0) timesteps to fail element. Default is no failure due to maximum principal stress.
NUM	Number of timesteps at or above PFAIL to trigger element failure

Remarks:

The yield stress function, Φ , is defined by:

$$\Phi = \hat{\sigma} - \sigma_y .$$

The equivalent stress, $\hat{\sigma}$, is given by:

$$\hat{\sigma}^2 = \frac{\sigma_{VM}^2 + \alpha^2 \sigma_m^2}{1 + \left(\frac{\alpha}{3}\right)^2} ,$$

where, σ_{VM} , is the von Mises effective stress:

$$\sigma_{VM} = \sqrt{\frac{2}{3} \sigma^{\text{dev}} : \sigma^{\text{dev}}} .$$

In this equation σ_m and σ^{dev} are the mean and deviatoric stress:

$$\sigma^{\text{dev}} = \sigma - \sigma_m \mathbf{I} .$$

The yield stress, σ_y , can be expressed as:

$$\sigma_y = \sigma_p + \gamma \frac{\hat{\varepsilon}}{\varepsilon_D} + \alpha_2 \ln \left[\frac{1}{1 - \left(\frac{\hat{\varepsilon}}{\varepsilon_D}\right)^\beta} \right] .$$

Here, σ_p , α_2 , γ , and β are material parameters. The densification strain ε_D is defined as:

$$\varepsilon_D = -\ln\left(\frac{\rho_f}{\rho_{f0}}\right),$$

where ρ_f is the foam density and ρ_{f0} is the density of the virgin material.

***MAT_PLASTICITY_COMPRESSION_TENSION_EOS**

This is Material Type 155. An isotropic elastic-plastic material where unique yield stress as a function of plastic strain curves can be defined for compression and tension. Also, failure can occur based on a plastic strain or a minimum time step size. Rate effects on the yield stress are modeled either by using the Cowper-Symonds strain rate model or by using two load curves that scale the yield stress values in compression and tension, respectively. Material rate effects, which are independent of the plasticity model, are based on a 6-term Prony series Maxwell mode that generates an additional stress tensor. The viscous stress tensor is superimposed on the stress tensor generated by the plasticity. Pressure is defined by an equation of state, which is required to utilize this model. This model is applicable to solid elements and SPH.

Card Summary:

Card 1. This card is required.

MID	RO	E	PR	C	P	FAIL	TDEL
-----	----	---	----	---	---	------	------

Card 2. This card is required.

LCIDC	LCIDT	LCSRC	LCSRT	SRFLAG			
-------	-------	-------	-------	--------	--	--	--

Card 3. This card is required.

PC	PT	PCUTC	PCUTT	PCUTF	SCALEP	SCALEE	
----	----	-------	-------	-------	--------	--------	--

Card 4. This card is required.

K							
---	--	--	--	--	--	--	--

Card 5. This card is optional. Up to six cards may be input. The next keyword ("*") card terminates this input.

G_i	BETA $_i$						
-------	-----------	--	--	--	--	--	--

Data Card Definitions:

Card 1	1	2	3	4	5	6	7	8
Variable	MID	RO	E	PR	C	P	FAIL	TDEL
Type	A	F	F	F	F	F	F	F
Default	none	none	none	none	0.0	0.0	10 ²⁰	0.0

VARIABLE**DESCRIPTION**

MID	Material identification. A unique number or label must be specified.
RO	Mass density
E	Young's modulus
PR	Poisson's ratio
C	Strain rate parameter, C ; see Remarks below.
P	Strain rate parameter, p ; see Remarks below.
FAIL	Failure flag: LT.0.0: User defined failure subroutine, <code>matusr_24</code> in <code>dyn21.F</code> , is called to determine failure EQ.0.0: Failure is not considered. This option is recommended if failure is not of interest since many calculations will be saved. GT.0.0: Plastic strain to failure. When the plastic strain reaches this value, the element is deleted from the calculation.
TDEL	Minimum time step size for automatic element deletion

Card 2	1	2	3	4	5	6	7	8
Variable	LCIDC	LCIDT	LCSRC	LCSRT	SRFLAG			
Type	I	I	I	I	F			
Default	0	0	0	0	0.0			

VARIABLE**DESCRIPTION**

LCIDC	Load curve ID defining effective yield stress as a function of effective plastic strain in compression
LCIDT	Load curve ID defining effective yield stress as a function of effective plastic strain in tension.
LCSRC	Optional load curve ID defining strain rate scaling effect on yield stress when the material is in compression (compressive yield stress scaling factor as a function of strain rate).
LCSRT	Optional load curve ID defining strain rate scaling effect on yield stress when the material is in tension (tensile yield stress scaling factor as a function of strain rate).
SRFLAG	Formulation for rate effects: EQ.0.0: Total strain rate EQ.1.0: Deviatoric strain rate

Card 3	1	2	3	4	5	6	7	8
Variable	PC	PT	PCUTC	PCUTT	PCUTF	SCALEP	SCALEE	
Type	F	F	F	F	F	F	F	
Default	0.0	0.0	0.0	0.0	0.0	0.0	0.0	

VARIABLE	DESCRIPTION
PC	Compressive mean stress at which the yield stress follows load curve ID LCIDC. If the pressure falls between PC and PT, a weighted average of the two load curves is used.
PT	Tensile mean stress at which the yield stress follows load curve ID LCIDT.
PCUTC	Pressure cut-off in compression. When the pressure cut-off is reached, the deviatoric stress tensor is set to zero. The compressive pressure is not, however, limited to PCUTC. Like the yield stress, PCUTC is scaled to account for rate effects.
PCUTT	Pressure cut-off in tension. When the pressure cut-off is reached, the deviatoric stress tensor and tensile pressure is set to zero. Like the yield stress, PCUTT is scaled to account for rate effects.
PCUTF	Pressure cut-off flag: EQ.0.0: inactive EQ.1.0: active
SCALEP	Scale factor applied to the yield stress after the pressure cut-off is reached in either compression or tension. If SCALEP = 0.0 (default), the deviatoric stress is set to zero after the cut-off is reached.
SCALEE	Scale factor applied to the yield stress after the strain exceeds the failure strain set by FAIL. If SCALEE = 0.0 (default), the deviatoric strain is set to zero if the failure strain is exceeded. <i>If both SCALEP > 0 and SCALEE > 0 and both failure conditions are met, then the minimum scale factor is used.</i>

Card 4	1	2	3	4	5	6	7	8
Variable	K							
Type	F							

VARIABLE	DESCRIPTION
K	Optional bulk modulus for the viscoelastic material. If nonzero a Kelvin type behavior will be obtained. Generally, K is set to zero.

Viscoelastic Constant Cards. Card format for viscoelastic constants. Up to 6 cards may be input. The next keyword ("*") cards terminates this input.

Card 5	1	2	3	4	5	6	7	8
Variable	G_i	BETA i						
Type	F	F						

VARIABLE**DESCRIPTION**

G_i	Optional shear relaxation modulus for the i^{th} term
BETA i	Optional shear decay constant for the i^{th} term

Remarks:

The effective yield stress as a function of effective plastic strain behavior follows a different curve in compression than it does in tension. Tension is determined by the sign of the mean stress where a positive mean stress (meaning a negative pressure) is indicative of tension. Two curves must be defined giving the yield stress as a function of effective plastic strain. One curve is for the tensile regime and the other curve is for the compressive regime.

Mean stress is an invariant which can be expressed as $(\sigma_x + \sigma_y + \sigma_z)/3$. PC and PT define a range of mean stress values within which interpolation is done between the tensile yield surface and compressive yield surface. PC and PT are not true material properties but are just a numerical convenience so that the transition from one yield surface to the other is not as abrupt as the sign of the mean stress changes. Both PC, PT, PCUTC, and PCUTT may all be input as positive values. It is implied that PC and PCUTC are compressive values and that PT and PCUTT are tensile values. The algebraic sign given these variables by the user is inconsequential.

Strain rate may be accounted for by using either two curves of yield stress scaling factor as a function of strain rate or a Cowper and Symonds model. The two curves in the former approach are used directly, that is, the curves are not rediscrretized before being used by the material model. The Cowper and Symonds model scales the yield stress with the factor:

$$1 + \left(\frac{\dot{\epsilon}}{C}\right)^{1/p},$$

where $\dot{\epsilon}$ is the strain rate,

$$\dot{\epsilon} = \sqrt{\dot{\epsilon}_{ij}\dot{\epsilon}_{ij}} .$$

History Variables:

History Variable	Description
4	Tensile pressure cutoff (set to zero if tensile or compressive failure occurs)
5	The cutoff flag, initially equals 1; set to 0 if tensile or compressive failure occurs.
6	The failure mode flag EQ.0: No failure EQ.1: Compressive failure EQ.2: Tensile failure EQ.3: Failure by plastic strain
7	The current flow stress

***MAT_MUSCLE**

This is Material Type 156 for truss elements. This material is a Hill-type muscle model with activation and a parallel damper. Also, see *MAT_SPRING_MUSCLE (*MAT_S15) where a description of the theory is available.

Card 1	1	2	3	4	5	6	7	8
Variable	MID	RO	SNO	SRM	PIS	SSM	CER	DMP
Type	A	F	F	F	F	F	F	F

Card 2	1	2	3	4	5	6	7	8
Variable	ALM	SFR	SVS	SVR	SSP			
Type	F	F	F	F	F			
Default	0.0	1.0	1.0	1.0	0.0			

VARIABLE**DESCRIPTION**

MID	Material identification. A unique number or label must be specified (see *PART).
RO	Material density in the initial undeformed configuration
SNO	Initial stretch ratio, l_0/l_{orig} , meaning the length as defined by the nodal points at $t = 0$ divided by the original initial length. The density for the nodal mass calculation is RO/SNO , or $\rho l_{orig}/l_0$.
SRM	Maximum strain rate
PIS	Peak isometric stress corresponding to the dimensionless value of unity in the dimensionless stress as a function of strain; see SSP below.
SSM	Strain when the dimensionless stress as a function of strain, SSP below, reaches its maximum stress value
CER	Constant, governing the exponential rise of SSP. Required if $SSP = 0.0$.

VARIABLE	DESCRIPTION
DMP	Damping constant (stress \times time units)
ALM	Activation level as a function of time: LT.0.0: Absolute value gives load curve ID. GE.0.0: Constant value of ALM is used.
SFR	Scale factor for strain rate maximum as a function of activation level, $a(t)$: LT.0.0: Absolute value gives load curve ID. GE.0.0: Constant value of 1.0 is used.
SVS	Active dimensionless tensile stress as a function of the stretch ratio, l/l_{orig} : LT.0.0: Absolute value gives load curve ID. GE.0.0: Constant value of 1.0 is used.
SVR	Active dimensionless tensile stress as a function of the normalized strain rate, $\dot{\epsilon}$: LT.0.0: Absolute value gives load curve ID. GE.0.0: Constant value of 1.0 is used.
SSP	Isometric dimensionless stress as a function of the stretch ratio, l/l_{orig} , for the parallel elastic element: LT.0.0: Absolute value gives load curve ID or table ID (see Remarks). EQ.0.0: Exponential function is used (see Remarks). GT.0.0: Constant value of 0.0 is used.

Remarks:

The material behavior of the muscle model is adapted from *MAT_S15 (the spring muscle model) and treated here as a standard material. The initial length of muscle is calculated automatically. The force, relative length and shortening velocity are replaced by stress, strain, and strain rate. A new parallel damping element is added.

The strain ϵ and normalized strain rate $\dot{\epsilon}$ are defined respectively as

$$\begin{aligned}\varepsilon &= \frac{l}{l_{\text{orig}}} - 1 \\ &= \text{SNO} \times \frac{l}{l_0} - 1\end{aligned}$$

and,

$$\begin{aligned}\dot{\varepsilon} &= \frac{l}{l_{\text{orig}}} \frac{\dot{\varepsilon}}{\dot{\varepsilon}_{\text{max}}} \\ &= \text{SNO} \times \frac{l}{l_0} \times \frac{\dot{\varepsilon}}{\text{SFR} \times \text{SRM}}\end{aligned}$$

where $\dot{\varepsilon} = \Delta\varepsilon/\Delta t$ (current strain increment divided by current time step), l is the current muscle length, and l_{orig} is the original muscle length.

From the relation above, it is known:

$$l_{\text{orig}} = \frac{l_0}{1 + \varepsilon_0}$$

where $\varepsilon_0 = \text{SNO} - 1$ and l_0 is the muscle length at $t = 0$.

Stress of Contractile Element is:

$$\sigma_1 = \sigma_{\text{max}} a(t) f\left(\frac{l}{l_{\text{orig}}}\right) g(\dot{\varepsilon}),$$

where $\sigma_{\text{max}} = \text{PIS}$, $a(t) = \text{ALM}$, $f(l/l_{\text{orig}}) = \text{SVS}$, and $g(\dot{\varepsilon}) = \text{SVR}$.

Stress of Passive Element is:

$$\sigma_2 = \begin{cases} \sigma_{\text{max}} h\left(\frac{l}{l_{\text{orig}}}\right) & \text{for curve} \\ \sigma_{\text{max}} h\left(\dot{\varepsilon}, \frac{l}{l_{\text{orig}}}\right) & \text{for table} \end{cases}$$

where $h = \text{SSP}$. For $\text{SSP} < 0$, the absolute value gives a load curve ID or table ID. The load curve defines isometric dimensionless stress h as a function of stretch ratio l/l_{orig} . The table defines for each normalized strain rate $\dot{\varepsilon}$ a load curve giving the isometric dimensionless stress h as a function of stretch ratio l/l_{orig} for that rate.

For the exponential relationship ($\text{SSP} = 0$):

$$h\left(\frac{l}{l_{\text{orig}}}\right) = \begin{cases} 0 & \frac{l}{l_{\text{orig}}} < 1 \\ \frac{1}{\exp(\text{CER}) - 1} \left[\exp\left(\frac{\text{CER}}{\text{SSM}} \varepsilon\right) - 1 \right] & \frac{l}{l_{\text{orig}}} \geq 1 \quad \text{CER} \neq 0 \\ \frac{\varepsilon}{\text{SSM}} & \frac{l}{l_{\text{orig}}} \geq 1 \quad \text{CER} = 0 \end{cases}$$

Stress of Damping Element is:

$$\sigma_3 = \text{DMP} \times \frac{l}{l_{\text{orig}}} \dot{\epsilon} .$$

Total Stress is:

$$\sigma = \sigma_1 + \sigma_2 + \sigma_3 .$$

***MAT_ANISOTROPIC_ELASTIC_PLASTIC**

This is Material Type 157. This material model is a combination of the anisotropic elastic material model (*MAT_002) and the anisotropic plastic material model (*MAT_103_P). Brittle orthotropic failure based on a phenomenological Tsai-Wu or Tsai-Hill criterion can be defined. This material is available for solid, shell, and thick shell (formulations 1, 2, and 6) elements.

Card Summary:

Card 1. This card is required.

MID	RO	SIGY	LCSS	QR1	CR1	QR2	CR2
-----	----	------	------	-----	-----	-----	-----

Card 2. This card is required.

C11	C12	C13	C14	C15	C16	C22	C23
-----	-----	-----	-----	-----	-----	-----	-----

Card 3. This card is required.

C24	C25	C26	C33	C34	C35	C36	C44
-----	-----	-----	-----	-----	-----	-----	-----

Card 4a. This card is included if the element type is shells or thick shells.

C45	C46	C55	C56	C66	R00	R45	R90
-----	-----	-----	-----	-----	-----	-----	-----

Card 4b. This card is included if the element type is solids.

C45	C46	C55	C56	C66	F	G	H
-----	-----	-----	-----	-----	---	---	---

Card 5a. This card is included if the element type is shells or thick shells.

S11	S22	S33	S12	AOPT	VP		
-----	-----	-----	-----	------	----	--	--

Card 5a. This card is included if the element type is solids.

L	M	N		AOPT	VP		MACF
---	---	---	--	------	----	--	------

Card 6. This card is required.

XP	YP	ZP	A1	A2	A3	ID3UPD	EXTRA
----	----	----	----	----	----	--------	-------

Card 7. This card is required.

V1	V2	V3	D1	D2	D3	BETA	IHIS
----	----	----	----	----	----	------	------

Card 8. This card is included if EXTRA = 1 or 2.

XT	XC	YT	YC	SXY	FF12		NCFAIL
----	----	----	----	-----	------	--	--------

Card 9. This card is included if EXTRA = 1 or 2.

ZT	ZC	SYZ	SZX	FF23	FF31		
----	----	-----	-----	------	------	--	--

Data Card Definitions:

Card 1	1	2	3	4	5	6	7	8
Variable	MID	RO	SIGY	LCSS	QR1	CR1	QR2	CR2
Type	A	F	F	F	F	F	F	F

VARIABLE

DESCRIPTION

MID Material identification. A unique number or label must be specified (see *PART).

RO Mass density

SIGY Initial yield stress

LCSS Load curve ID or Table ID:

Load Curve. When LCSS is a load curve ID, it is taken as defining effective stress as a function of effective plastic strain. If defined QR1, CR1, QR2, and CR2 are ignored.

Tabular Data. The table ID defines for each strain rate value a load curve ID giving the stress as a function of effective plastic strain for that rate, See [Figure M24-1](#). When the strain rate falls below the minimum value, the stress as a function of effective plastic strain curve for the lowest value of strain rate is used. Likewise, when the strain rate exceeds the maximum value the stress as a function of effective plastic strain curve for the highest value of strain rate is used.

VARIABLE

DESCRIPTION

Logarithmically Defined Tables. An alternative way to invoke logarithmic interpolation between discrete strain rates is described as follows. If the *first* value in the table is negative, LS-DYNA assumes that all the table values represent the natural logarithm of a strain rate. Since the tables are internally discretized to equally space the table values, it makes good sense from an accuracy standpoint that the table values represent the natural log of strain rate when the lowest strain rate and highest strain rate differ by several orders of magnitude. Logarithmic interpolation has some additional computational cost.

- QR1 Isotropic hardening parameter
- CR1 Isotropic hardening parameter
- QR2 Isotropic hardening parameter
- CR2 Isotropic hardening parameter

Card 2	1	2	3	4	5	6	7	8
Variable	C11	C12	C13	C14	C15	C16	C22	C23
Type	F	F	F	F	F	F	F	F

Card 3	1	2	3	4	5	6	7	8
Variable	C24	C25	C26	C33	C34	C35	C36	C44
Type	F	F	F	F	F	F	F	F

VARIABLE

DESCRIPTION

- C_{ij} The ij^{th} term in the 6×6 anisotropic constitutive matrix. Note that 1 corresponds to the *a* material direction, 2 to the *b* material direction, and 3 to the *c* material direction.

Anisotropic Constants Card for Shells. This card is included if the element type is shells or thick shells.

Card 4a	1	2	3	4	5	6	7	8
Variable	C45	C46	C55	C56	C66	R00	R45	R90
Type	F	F	F	F	F	F	F	F

VARIABLE**DESCRIPTION**

C_{ij}	The ij^{th} term in the 6×6 anisotropic constitutive matrix
R00	R_{00} for shell (default = 1.0)
R45	R_{45} for shell (default = 1.0)
R90	R_{90} for shell (default = 1.0)

Anisotropic Constants Card for Solids. This card is included if the element type is solids.

Card 4b	1	2	3	4	5	6	7	8
Variable	C45	C46	C55	C56	C66	F	G	H
Type	F	F	F	F	F	F	F	F

VARIABLE**DESCRIPTION**

C_{ij}	The ij^{th} term in the 6×6 anisotropic constitutive matrix
F	F for solid (default = 1/2)
G	G for solid (default = 1/2)
H	H for solid (default = 1/2)

Shell Yield Stress Card. This card is included if and only if the element type is shells or thick shells.

Card 5a	1	2	3	4	5	6	7	8
Variable	S11	S22	S33	S12	AOPT	VP		
Type	F	F	F	F	F	F		

VARIABLE**DESCRIPTION**

S11	Yield stress in local- <i>x</i> direction (shells only). This input is ignored when R00, R45, and R90 are greater than 0.
S22	Yield stress in local- <i>y</i> direction (shells only). This input is ignored when R00, R45, and R90 are greater than 0.
S33	Yield stress in local- <i>z</i> direction (shells only). This input is ignored when R00, R45, and R90 are greater than 0.
S12	Yield stress in local <i>xy</i> -direction (shells only). This input is ignored when R00, R45, and R90 are greater than 0.
AOPT	<p>Material axes option (see MAT_OPTIONTROPIC_ELASTIC, particularly the Material Directions section, for details):</p> <p>EQ.0.0: Locally orthotropic with material axes determined by element nodes 1, 2, and 4, as with *DEFINE_COORDINATE_NODES. For shells only, the material axes are then rotated about the normal vector to the surface of the shell by the angle BETA.</p> <p>EQ.2.0: Globally orthotropic with material axes determined by vectors defined below, as with *DEFINE_COORDINATE_VECTOR</p> <p>EQ.3.0: Locally orthotropic material axes determined by a vector v and the normal vector to the plane of the element. a is determined by taking the cross product of v with the normal vector, b is determined by taking the cross product of the normal vector with a, and c is the normal vector. Then a and b are rotated about c by an angle BETA. BETA may be set in the keyword input for the element or in the input for this keyword.</p> <p>LT.0.0: The absolute value of AOPT is a coordinate system ID number (CID on *DEFINE_COORDINATE_OPTION).</p>

VARIABLE	DESCRIPTION
VP	Formulation for rate effects: EQ.0.0: Scale yield stress (default) EQ.1.0: Viscoplastic formulation

Anisotropic Constants Card for Solids. This card is included if the element type is solids.

Card 5b	1	2	3	4	5	6	7	8
Variable	L	M	N		AOPT	VP		MACF
Type	F	F	F		F	F		F

VARIABLE	DESCRIPTION
L	<i>L</i> for solid (default = 3/2)
M	<i>M</i> for solid (default = 3/2)
N	<i>N</i> for solid (default = 3/2)
AOPT	Material axes option (see MAT_OPTIONTROPIC_ELASTIC, particularly the Material Directions section, for details): EQ.0.0: Locally orthotropic with material axes determined by element nodes 1, 2, and 4, as with *DEFINE_COORDINATE_NODES. For shells only, the material axes are then rotated about the normal vector to the surface of the shell by the angle BETA. EQ.1.0: Locally orthotropic with material axes determined by a point, <i>P</i> , in space and the global location of the element center; this is the a -direction. EQ.2.0: Globally orthotropic with material axes determined by vectors defined below, as with *DEFINE_COORDINATE_VECTOR

VARIABLE**DESCRIPTION**

	<p>EQ.3.0: Locally orthotropic material axes determined by a vector \mathbf{v} and the normal vector to the plane of the element. The plane of a solid element is the midsurface between the inner surface and outer surface defined by the first four nodes and the last four nodes of the connectivity of the element, respectively. Thus, for solid elements, $AOPT = 3$ is only available for hexahedrons. \mathbf{a} is determined by taking the cross product of \mathbf{v} with the normal vector, \mathbf{b} is determined by taking the cross product of the normal vector with \mathbf{a}, and \mathbf{c} is the normal vector. Then \mathbf{a} and \mathbf{b} are rotated about \mathbf{c} by an angle BETA. BETA may be set in the keyword input for the element or in the input for this keyword. Note that for solids, the material axes may be switched depending on the choice of MACF. The switch may occur before or after applying BETA depending on the value of MACF.</p> <p>EQ.4.0: Locally orthotropic in a cylindrical coordinate system with the material axes determined by a vector \mathbf{v}, and an originating point, P, which define the centerline axis.</p> <p>LT.0.0: The absolute value of AOPT is a coordinate system ID number (CID on *DEFINE_COORDINATE_OPTION).</p>
VP	<p>Formulation for rate effects:</p> <p>EQ.0.0: Scale yield stress (default)</p> <p>EQ.1.0: Viscoplastic formulation</p>

VARIABLE	DESCRIPTION
----------	-------------

MACF Material axes change flag for solid elements:

EQ.-4: Switch material axes *b* and *c* before BETA rotation
 EQ.-3: Switch material axes *a* and *c* before BETA rotation
 EQ.-2: Switch material axes *a* and *b* before BETA rotation
 EQ.1: No change, default
 EQ.2: Switch material axes *a* and *b* after BETA rotation
 EQ.3: Switch material axes *a* and *c* after BETA rotation
 EQ.4: Switch material axes *b* and *c* after BETA rotation

Figure M2-2 indicates when LS-DYNA applies MACF during the process to obtain the final material axes. If BETA on *ELEMENT_-SOLID_{OPTION} is defined, then that BETA is used for the rotation for all AOPT options. Otherwise, if AOPT = 3, the BETA input on Card 7 rotates the axes. For all other values of AOPT, the material axes will be switched as specified by MACF, but no BETA rotation will be performed.

Card 6	1	2	3	4	5	6	7	8
Variable	XP	YP	ZP	A1	A2	A3	ID3UPD	EXTRA
Type	F	F	F	F	F	F	F	F

VARIABLE	DESCRIPTION
----------	-------------

XP, YP, ZP Coordinates of point *p* for AOPT = 1 and 4

A1, A2, A3 Components of vector **a** for AOPT = 2

EXTRA Flag to input further data (see [Remarks 3](#) and [4](#) below):
 EQ.1.0: Tsai-Wu failure criterion parameters (Cards 8 and 9)
 EQ.2.0: Tsai-Hill failure criterion parameters (Cards 8 and 9)

ID3UPD Flag for transverse through thickness strain update (thin shells only):

VARIABLE**DESCRIPTION**

EQ.0.0: Reflects R -values by splitting the strain tensor into elastic and plastic components

EQ.1.0: Elastic update using total strain tensor

Card 7	1	2	3	4	5	6	7	8
Variable	V1	V2	V3	D1	D2	D3	BETA	IHIS
Type	F	F	F	F	F	F	F	F

VARIABLE**DESCRIPTION**

V1, V2, V3

Components of vector \mathbf{v} for AOPT = 3 and 4

D1, D2, D3

Components of vector \mathbf{d} for AOPT = 2

BETA

Material angle in degrees for AOPT = 0 (shells and tshells only) and AOPT = 3. BETA may be overridden on the element card; see *ELEMENT_SHELL_BETA, *ELEMENT_TSHELL_BETA and *ELEMENT_SOLID_ORTHO.

IHIS

Flag for material properties initialization:

EQ.0: Material properties defined in Cards 1 - 5 are used

GE.1: Use *INITIAL_STRESS_SOLID/SHELL to initialize material properties on an element-by-element basis for solid or shell elements, respectively (see [Remarks 1](#) and [2](#) below).

Two additional cards for EXTRA = 1 or 2.

Card 8	1	2	3	4	5	6	7	8
Variable	XT	XC	YT	YC	SXY	FF12		NCFAIL
Type	F	F	F	F	F	F		F

VARIABLE**DESCRIPTION**

XT

Longitudinal tensile strength, a -axis:

VARIABLE	DESCRIPTION
	GT.0.0: Constant value LT.0.0: Load curve ID = (-XT) which defines the longitudinal tensile strength as a function of strain rate. If the first strain rate value in the curve is negative, it is assumed that all strain rate values are given as a natural logarithm of the strain rate.
XC	Longitudinal compressive strength, <i>a</i> -axis (positive value): GT.0.0: Constant value LT.0.0: Load curve ID = (-XC) which defines the longitudinal compressive strength as a function of strain rate. If the first strain rate value in the curve is negative, it is assumed that all strain rate values are given as a natural logarithm of the strain rate.
YT	Transverse tensile strength, <i>b</i> -axis: GT.0.0: Constant value LT.0.0: Load curve ID = (-YT) which defines the transverse tensile strength as a function of strain rate. If the first strain rate value in the curve is negative, it is assumed that all strain rate values are given as a natural logarithm of the strain rate.
YC	Transverse compressive strength, <i>b</i> -axis (positive value): GT.0.0: Constant value LT.0.0: Load curve ID = (-YC) which defines the transverse compressive strength as a function of strain rate. If the first strain rate value in the curve is negative, it is assumed that all strain rate values are given as a natural logarithm of the strain rate.
SXY	Shear strength, <i>ab</i> -plane: GT.0.0: Constant value LT.0.0: Load curve ID = (-SXY) which defines the shear strength as a function of strain rate. If the first strain rate value in the curve is negative, it is assumed that all strain rate values are given as a natural logarithm of the strain rate.

VARIABLE	DESCRIPTION
FF12	Scale factor between -1 and +1 for interaction term F12, see Remark 3 .
NCFAIL	Number of timesteps to reduce stresses until element deletion. The default is 10.

Card 9	1	2	3	4	5	6	7	8
Variable	ZT	ZC	SYZ	SZX	FF23	FF31		
Type	F	F	F	F	F	F		

VARIABLE	DESCRIPTION
ZT	<p>Transverse tensile strength, <i>c</i>-axis (<i>solid elements only</i>):</p> <p>GT.0.0: Constant value</p> <p>LT.0.0: Load curve ID = (-ZT) which defines the transverse tensile strength as a function of strain rate. If the first strain rate value in the curve is negative, all strain rate values are assumed to be given as a natural logarithm of the strain rate.</p>
ZC	<p>Transverse compressive strength, <i>c</i>-axis (positive value, <i>solid elements only</i>):</p> <p>GT.0.0: Constant value</p> <p>LT.0.0: Load curve ID = (-ZC) which defines the transverse compressive strength as a function of strain rate. If the first strain rate value in the curve is negative, all strain rate values are assumed to be given as a natural logarithm of the strain rate.</p>
SYZ	<p>Shear strength, <i>bc</i>-plane (<i>solid elements only</i>):</p> <p>GT.0.0: Constant value</p> <p>LT.0.0: Load curve ID = (-SYZ) which defines the shear strength as a function of strain rate. If the first strain rate value in the curve is negative, it is assumed that all strain rate values are given as a natural logarithm of the strain rate.</p>
SZX	<p>Shear strength, <i>ca</i>-plane (<i>solid elements only</i>):</p>

VARIABLE	DESCRIPTION
	GT.0.0: Constant value
	LT.0.0: Load curve ID = (-SZX) which defines the shear strength as a function of strain rate. If the first strain rate value in the curve is negative, it is assumed that all strain rate values are given as a natural logarithm of the strain rate.
FF23	Scale factor between -1 and +1 for interaction term F23; see Remark 3 (<i>solid elements only</i>).
FF31	Scale factor between -1 and +1 for interaction term F31; see Remark 3 (<i>solid elements only</i>).

Remarks:

- Description of IHIS (Solid Elements).** Several of this material's parameters may be overwritten on an element-by-element basis through history variables using the *INITIAL_STRESS_SOLID keyword. Bitwise (binary) expansion of IHIS determines which material properties are to be read:

$$IHIS = a_4 \times 16 + a_3 \times 8 + a_2 \times 4 + a_1 \times 2 + a_0,$$

where each a_i is a binary flag set to either 1 or 0. The a_i are interpreted according to the following table.

Flag	Description	Variables	#
a_0	Material directions	$q_{11}, q_{12}, q_{13}, q_{31}, q_{32}, q_{33}$	6
a_1	Anisotropic stiffness	C_{ij}	21
a_2	Anisotropic constants	F, G, H, L, M, N	6
a_3	Stress-strain Curve	LCSS	1
a_4	Strength limits	XT, XC, YT, YC, ZT, ZC, SXY, SYZ, SZX	9

The NHISV field on *INITIAL_STRESS_SOLID must be set equal to the sum of the number of variables to be read in, which depends on IHIS (and the a_i):

$$NHISV = 6a_0 + 21a_1 + 6a_2 + a_3 + 9a_4.$$

Then, in the following order, *INITIAL_STRESS_SOLID processes the history variables, HISV $_i$, as:

- 6 material direction parameters when $a_0 = 1$
- 21 anisotropic stiffness parameters when $a_1 = 1$

- c) 6 anisotropic constants when $a_2 = 1$
- d) 1 parameter when $a_3 = 1$
- e) 9 strength parameters when $a_4 = 1$

The q_{ij} terms are the first and third rows of a rotation matrix for the rotation from a co-rotational element's system and the a - b - c material directions. The c_{ij} terms are the upper triangular terms of the symmetric stiffness matrix, $c_{11}, c_{12}, c_{13}, c_{14}, c_{15}, c_{16}, c_{22}, c_{23}, c_{24}, c_{25}, c_{26}, c_{33}, c_{34}, c_{35}, c_{36}, c_{44}, c_{45}, c_{46}, c_{55}, c_{56}$, and c_{66} .

2. **Description of IHIS (Shell Elements).** Several of this material's parameters may be overwritten on an element-by-element basis through history variables using the *INITIAL_STRESS_SHELL keyword. Bitwise (binary) expansion of IHIS determines which material properties are to be read:

$$\text{IHIS} = a_4 \times 16 + a_3 \times 8 + a_2 \times 4 + a_1 \times 2 + a_0,$$

where each a_i is a binary flag set to either 1 or 0. The a_i are interpreted according to the following table.

Flag	Description	Variables	#
a_0	Material directions	q_1, q_2	2
a_1	Anisotropic stiffness	C_{ij}	21
a_2	Anisotropic constants	r_{00}, r_{45}, r_{90}	3
a_3	Stress-strain curve	LCSS	1
a_4	Strength limits	XT, XC, YT, YC, SXY	5

The NHISV field on *INITIAL_STRESS_SHELL must be set equal to the sum of the number of variables to be read in, which depends on IHIS (and the a_i):

$$\text{NHISV} = 2a_0 + 21a_1 + 3a_2 + a_3 + 5a_4.$$

Then, in the following order, *INITIAL_STRESS_SHELL processes the history variables, HISV $_i$, as:

- a) 2 material direction parameters when $a_0 = 1$
- b) 21 anisotropic stiffness parameters when $a_1 = 1$
- c) 3 anisotropic constants when $a_2 = 1$
- d) 1 parameter when $a_3 = 1$
- e) 5 strength parameters when $a_4 = 1$

The q_i terms are the material direction cosine and sine for the rotation from a rotational element's system to the a - b - c material directions. The c_{ij} terms are the upper triangular terms of the symmetric stiffness matrix, c_{11} , c_{12} , c_{13} , c_{14} , c_{15} , c_{16} , c_{22} , c_{23} , c_{24} , c_{25} , c_{26} , c_{33} , c_{34} , c_{35} , c_{36} , c_{44} , c_{45} , c_{46} , c_{55} , c_{56} , and c_{66} .

3. **Tsai-Wu failure criterion (EXTRA = 1).** Brittle failure with different strengths in tension and compression in all main material directions can be invoked with EXTRA = 1 and the definition of corresponding parameters on Cards 8 and 9. The model used is the phenomenological Tsai-Wu failure criterion which requires that

$$\begin{aligned} & \left(\frac{1}{XT} - \frac{1}{XC} \right) \sigma_{aa} + \left(\frac{1}{YT} - \frac{1}{YC} \right) \sigma_{bb} + \left(\frac{1}{ZT} - \frac{1}{ZC} \right) \sigma_{cc} + \frac{1}{XT \times XC} \sigma_{aa}^2 \\ & + \frac{1}{YT \times YC} \sigma_{bb}^2 + \frac{1}{ZT \times ZC} \sigma_{cc}^2 + \frac{1}{SXY^2} \sigma_{ab}^2 + \frac{1}{SYZ^2} \sigma_{bc}^2 + \frac{1}{SZX^2} \sigma_{ca}^2 \\ & + 2 \times F_{12} \times \sigma_{aa} \sigma_{bb} + 2 \times F_{23} \times \sigma_{bb} \sigma_{cc} + 2 \times F_{31} \times \sigma_{cc} \sigma_{aa} < 1 \end{aligned}$$

for the 3-dimensional case (solid elements) with three planes of symmetry with respect to the material coordinate system. The interaction terms F_{12} , F_{23} , and F_{31} are given by

$$\begin{aligned} F_{12} &= FF12 \times \sqrt{\frac{1}{XT \times XC \times YT \times YC}} \\ F_{23} &= FF23 \times \sqrt{\frac{1}{YT \times YC \times ZT \times ZC}} \\ F_{31} &= FF31 \times \sqrt{\frac{1}{ZT \times ZC \times XT \times XC}} \end{aligned}$$

For the 2-dimensional case of plane stress (shell elements), this expression reduces to:

$$\begin{aligned} & \left(\frac{1}{XT} - \frac{1}{XC} \right) \sigma_{aa} + \left(\frac{1}{YT} - \frac{1}{YC} \right) \sigma_{bb} + \frac{1}{XT \times XC} \sigma_{aa}^2 + \frac{1}{YT \times YC} \sigma_{bb}^2 \\ & + \frac{1}{SXY^2} \sigma_{ab}^2 + 2 \times F_{12} \times \sigma_{aa} \sigma_{bb} < 1 \end{aligned}$$

If these conditions are violated, then the stress tensor will be reduced to zero over NCFail time steps and then the element gets eroded. A small value for NCFail (< 50) is recommended to avoid unphysical behavior; the default is 10. The default values for the strengths XT, XC, YT, YC, ZT, ZC, SXY, SYZ, and SZX are 10^{20} , that is, basically no limits. The scale factors FF12, FF23, and FF31 for the interaction terms are zero by default.

4. **Tsai-Hill failure criterion (EXTRA = 2).** Brittle failure with different strengths in tension and compression in all main material directions can be invoked with EXTRA = 2 and the definition of corresponding parameters on Cards 8 and 9

(FF12, FF23 and FF31 are not used in this model). The model is based on the HILL criterion which can be written as

$$(G + H)\sigma_{aa}^2 + (F + H)\sigma_{bb}^2 + (F + G)\sigma_{cc}^2 - 2H\sigma_{aa}\sigma_{bb} - 2F\sigma_{bb}\sigma_{cc} - 2G\sigma_{cc}\sigma_{aa} + 2N\sigma_{ab}^2 + 2L\sigma_{bc}^2 + 2M\sigma_{ca}^2 < 1$$

for the 3-dimensional case. The constants $H, F, G, N, L,$ and M can be expressed in terms of the strength limits (which then becomes the TSAI-HILL criterion) as

$$\begin{aligned} G + H &= \frac{1}{X_i^2} & 2N &= \frac{1}{SXY^2} & H &= 0.5 \times \left(\frac{1}{X_i^2} + \frac{1}{Y_i^2} - \frac{1}{Z_i^2} \right) \\ F + H &= \frac{1}{Y_i^2} & 2L &= \frac{1}{SYZ^2} & F &= 0.5 \times \left(\frac{1}{Y_i^2} + \frac{1}{Z_i^2} - \frac{1}{X_i^2} \right) \\ F + G &= \frac{1}{Z_i^2} & 2M &= \frac{1}{SZX^2} & G &= 0.5 \times \left(\frac{1}{X_i^2} + \frac{1}{Z_i^2} - \frac{1}{Y_i^2} \right) \end{aligned}$$

where the current stress state defines whether the compressive or the tensile strength limit will enter into the equation:

$$\begin{aligned} X_i &= \begin{cases} XT & \text{if } \sigma_{aa} > 0 \\ XC & \text{if } \sigma_{aa} < 0 \end{cases} \\ Y_i &= \begin{cases} YT & \text{if } \sigma_{bb} > 0 \\ YC & \text{if } \sigma_{bb} < 0 \end{cases} \\ Z_i &= \begin{cases} ZT & \text{if } \sigma_{cc} > 0 \\ ZC & \text{if } \sigma_{cc} < 0 \end{cases} \end{aligned}$$

For the 2-dimensional case of plane stress (shell elements) the TSAI-HILL criterion reduces to:

$$(G + H)\sigma_{aa}^2 + (F + H)\sigma_{bb}^2 - 2H\sigma_{aa}\sigma_{bb} + 2N\sigma_{ab}^2 < 1$$

with

$$\begin{aligned} G + H &= \frac{1}{X_i^2} \\ F + H &= \frac{1}{Y_i^2} \\ H &= 0.5 \times \frac{1}{X_i^2} \\ 2N &= \frac{1}{SXY^2} \end{aligned}$$

If these conditions are violated, then the stress tensor will be reduced to zero over NCFail time steps and the element will be eroded. A small value for NCFail (< 50) is recommended to avoid unphysical behavior; the default is 10. The default values for the strengths XT, XC, YT, YC, ZT, ZC, SXY, SYZ, and SZX are 10^{20} , meaning basically no limits.

*MAT_RATE_SENSITIVE_COMPOSITE_FABRIC

This is Material Type 158. Depending on the type of failure surface, this model may be used to model rate sensitive composite materials with unidirectional layers, complete laminates, and woven fabrics. A viscous stress tensor, based on an isotropic Maxwell model with up to six terms in the Prony series expansion, is superimposed on the rate independent stress tensor of the composite fabric. The viscous stress tensor approach should work reasonably well if the stress increases due to rate affects are up to 15% of the total stress. This model is implemented for both shell and thick shell elements. The viscous stress tensor is effective at eliminating spurious stress oscillations.

Card Summary:

Card 1. This card is required.

MID	RO	EA	EB	(EC)	PRBA	TAU1	GAMMA1
-----	----	----	----	------	------	------	--------

Card 2. This card is required.

GAB	GBC	GCA	SLIMT1	SLIMC1	SLIMT2	SLIMC2	SLIMS
-----	-----	-----	--------	--------	--------	--------	-------

Card 3. This card is required.

AOPT	TSIZE	ERODS	SOFT	FS			
------	-------	-------	------	----	--	--	--

Card 4. This card is required.

XP	YP	ZP	A1	A2	A3	PRCA	PRCB
----	----	----	----	----	----	------	------

Card 5. This card is required.

V1	V2	V3	D1	D2	D3	BETA	
----	----	----	----	----	----	------	--

Card 6. This card is required.

E11C	E11T	E22C	E22T	GMS			
------	------	------	------	-----	--	--	--

Card 7. This card is required.

XC	XT	YC	YT	SC			
----	----	----	----	----	--	--	--

Card 8. This card is required.

K							
---	--	--	--	--	--	--	--

Card 9. Include up to 6 of this card. This input ends with the next keyword ("**") card.

G_i	BETA i							
-------	----------	--	--	--	--	--	--	--

Data Card Definitions:

Card 1	1	2	3	4	5	6	7	8
Variable	MID	RO	EA	EB	(EC)	PRBA	TAU1	GAMMA1
Type	A	F	F	F	F	F	F	F

VARIABLE

DESCRIPTION

MID	Material identification. A unique number or label must be specified (see *PART).
RO	Mass density
EA	E_a , Young's modulus - longitudinal direction
EB	E_b , Young's modulus - transverse direction
(EC)	E_c , Young's modulus - normal direction (not used)
PRBA	ν_{ba} , Poisson's ratio ba
TAU1	τ_1 , stress limit of the first slightly nonlinear part of the shear stress as a function of shear strain curve. The values τ_1 and γ_1 are used to define a curve of shear stress as a function of shear strain. These values are input if FS, defined in Card 3, is set to -1.
GAMMA1	γ_1 , strain limit of the first slightly nonlinear part of the shear stress as a function of shear strain curve

Card 2	1	2	3	4	5	6	7	8
Variable	GAB	GBC	GCA	SLIMIT1	SLIMC1	SLIMIT2	SLIMC2	SLIMS
Type	F	F	F	F	F	F	F	F

VARIABLE	DESCRIPTION
GAB	G_{ab} , shear modulus ab
GBC	G_{bc} , shear modulus bc
GCA	G_{ca} , shear modulus ca
SLIMT1	Factor to determine the minimum stress limit after stress maximum (fiber tension)
SLIMC1	Factor to determine the minimum stress limit after stress maximum (fiber compression)
SLIMT2	Factor to determine the minimum stress limit after stress maximum (matrix tension)
SLIMC2	Factor to determine the minimum stress limit after stress maximum (matrix compression)
SLIMS	Factor to determine the minimum stress limit after stress maximum (shear)

Card 3	1	2	3	4	5	6	7	8
Variable	AOPT	TSIZE	ERODS	SOFT	FS			
Type	F	F	F	F	F			

VARIABLE	DESCRIPTION
AOPT	<p>Material axes option (see MAT_OPTIONTROPIC_ELASTIC for a more complete description):</p> <p>EQ.0.0: Locally orthotropic with material axes determined by element nodes 1, 2, and 4, as with *DEFINE_COORDINATE_NODES, and then rotated about the shell element normal by the angle BETA</p> <p>EQ.2.0: Globally orthotropic with material axes determined by vectors defined below, as with *DEFINE_COORDINATE_VECTOR</p>

VARIABLE	DESCRIPTION
-----------------	--------------------

	<p>EQ.3.0: Locally orthotropic material axes determined by rotating the material axes about the element normal by an angle (BETA) from a line in the plane of the element defined by the cross product of the vector \mathbf{v} with the element normal</p> <p>LT.0.0: The absolute value of AOPT is a coordinate system ID number (CID on *DEFINE_COORDINATE_NODES, *DEFINE_COORDINATE_SYSTEM or *DEFINE_COORDINATE_VECTOR.</p>
TSIZE	Time step for automatic element deletion
ERODS	Maximum effective strain for element layer failure. A value of unity would equal 100% strain.
SOFT	Softening reduction factor for strength in the crashfront.
FS	<p>Failure surface type:</p> <p>EQ.1.0: Smooth failure surface with a quadratic criterion for both the fiber (a) and transverse (b) directions. This option can be used with complete laminates and fabrics.</p> <p>EQ.0.0: Smooth failure surface in the transverse (b) direction with a limiting value in the fiber (a) direction. This model is appropriate for unidirectional (UD) layered composites only.</p> <p>EQ.-1: Faceted failure surface. When the strength values are reached, then damage evolves in tension and compression for both the fiber and transverse direction. Shear behavior is also considered. This option can be used with complete laminates and fabrics.</p>

Card 4	1	2	3	4	5	6	7	8
Variable	XP	YP	ZP	A1	A2	A3	PRCA	PRCB
Type	F	F	F	F	F	F	F	F

VARIABLE	DESCRIPTION
-----------------	--------------------

XP, YP, ZP	Coordinates of point p for AOPT = 1
------------	---------------------------------------

VARIABLE	DESCRIPTION
----------	-------------

A1, A2, A3	Components of vector a for AOPT = 2
PRCA	ν_{ca} , Poisson's ratio <i>ca</i> (default = PRBA)
PRCB	ν_{cb} , Poisson's ratio <i>cb</i> (default = PRBA)

Card 5	1	2	3	4	5	6	7	8
Variable	V1	V2	V3	D1	D2	D3	BETA	
Type	F	F	F	F	F	F	F	

VARIABLE	DESCRIPTION
----------	-------------

V1, V2, V3	Components of vector v for AOPT = 3
D1, D2, D3	Components of vector d for AOPT = 2
BETA	Material angle in degrees for AOPT = 0 and 3. BETA may be overridden on the element card; see *ELEMENT_SHELL_BETA.

Card 6	1	2	3	4	5	6	7	8
Variable	E11C	E11T	E22C	E22T	GMS			
Type	F	F	F	F	F			

VARIABLE	DESCRIPTION
----------	-------------

E11C	Strain at longitudinal compressive strength, <i>a</i> -axis
E11T	Strain at longitudinal tensile strength, <i>a</i> -axis
E22C	Strain at transverse compressive strength, <i>b</i> -axis
E22T	Strain at transverse tensile strength, <i>b</i> -axis
GMS	Strain at shear strength, <i>ab</i> -plane

MAT_158**MAT_RATE_SENSITIVE_COMPOSITE_FABRIC**

Card 7	1	2	3	4	5	6	7	8
Variable	XC	XT	YC	YT	SC			
Type	F	F	F	F	F			

VARIABLE**DESCRIPTION**

XC	Longitudinal compressive strength; see Remark 2 of *MAT_058.
XT	Longitudinal tensile strength; see Remark 2 of *MAT_058.
YC	Transverse compressive strength, <i>b</i> -axis, see Remark 2 of *MAT_058.
YT	Transverse tensile strength, <i>b</i> -axis; see Remark 2 of *MAT_058.
SC	Shear strength, <i>ab</i> -plane; see Remark 2 of *MAT_058.

Card 8	1	2	3	4	5	6	7	8
Variable	K							
Type	F							

VARIABLE**DESCRIPTION**

K	Optional bulk modulus for the viscoelastic material. If nonzero, a Kelvin type behavior will be obtained. Generally, K is set to zero.
---	--

Viscoelastic Cards. Up to 6 cards may be input. The next keyword ("*") card terminates this input.

Card 9	1	2	3	4	5	6	7	8
Variable	G_i	BETA $_i$						
Type	F	F						

VARIABLE	DESCRIPTION
G_i	Optional shear relaxation modulus for the i^{th} term
BETA i	Optional shear decay constant for the i^{th} term

Remarks:

1. **Related Material.** See the Remarks for material type 58, [*MAT_LAMINATED_COMPOSITE_FABRIC](#), for the treatment of the composite material.
2. **Rate Effects.** Rate effects are taken into account through a Maxwell model using linear viscoelasticity by a convolution integral of the form:

$$\sigma_{ij} = \int_0^t g_{ijkl}(t - \tau) \frac{\partial \varepsilon_{kl}}{\partial \tau} d\tau ,$$

where $g_{ijkl}(t-\tau)$ is the relaxation functions for the different stress measures. This stress is added to the stress tensor determined from the strain energy functional. Since we wish to include only simple rate effects, the relaxation function is represented by six terms from the Prony series:

$$g(t) = \sum_{m=1}^N G_m e^{-\beta_m t}$$

We characterize this in the input by the shear moduli, G_i , and decay constants, β_i . An arbitrary number of terms, not exceeding 6, may be used when applying the viscoelastic model. The composite failure is not directly affected by the presence of the viscous stress tensor.

***MAT_CSCM_{OPTION}**

This is Material Type 159. This material model is a smooth or continuous surface cap model and is available for solid elements in LS-DYNA. The user has the option of inputting his own material properties (<BLANK> option) or requesting default material properties for normal strength concrete (CONCRETE). See [Murray 2007] for a more complete model description.

Available options include:

<BLANK>

CONCRETE

Card Summary:

Card 1. This card is required.

MID	RO	NPLOT	INCRE	IRATE	ERODE	RECOV	ITRETRC
-----	----	-------	-------	-------	-------	-------	---------

Card 2. This card is required.

PRED							
------	--	--	--	--	--	--	--

Card 3. This card is included if and only if the CONCRETE keyword option is used.

FPC	DAGG	UNITS					
-----	------	-------	--	--	--	--	--

Card 4. This card is included if and only if the keyword option is unused (<OPTION>).

G	K	ALPHA	THETA	LAMBDA	BETA	NH	CH
---	---	-------	-------	--------	------	----	----

Card 5. This card is included if and only if the keyword option is unused (<OPTION>).

ALPHA1	THETA1	LAMBDA1	BETA1	ALPHA2	THETA2	LAMBDA2	BETA2
--------	--------	---------	-------	--------	--------	---------	-------

Card 6. This card is included if and only if the keyword option is unused (<OPTION>).

R	X0	W	D1	D2			
---	----	---	----	----	--	--	--

Card 7. This card is included if and only if the keyword option is unused (<OPTION>).

B	GFC	D	GFT	GFS	PWRC	PWRT	PMOD
---	-----	---	-----	-----	------	------	------

Card 8. This card is included if and only if the keyword option is unused (<OPTION>).

ETA0C	NC	ETA0T	NT	OVERC	OVERT	SRATE	REPOW
-------	----	-------	----	-------	-------	-------	-------

Data Card Definitions:

Card 1	1	2	3	4	5	6	7	8
Variable	MID	RO	NPLOT	INCRE	IRATE	ERODE	RECOV	ITRETRC
Type	A	F	I	F	I	F	F	I

VARIABLE**DESCRIPTION**

MID	Material identification. A unique number or label must be specified (see *PART).
RO	Mass density
NPLOT	Controls what is written as component 7 to the d3plot database. LS-PrePost always labels this component as effective plastic strain: EQ.1: Maximum of brittle and ductile damage (default) EQ.2: Maximum of brittle and ductile damage, with recovery of brittle damage EQ.3: Brittle damage EQ.4: Ductile damage EQ.5: κ (intersection of cap with shear surface) EQ.6: X_0 (intersection of cap with pressure axis) EQ.7: ϵ_v^P (plastic volume strain).
INCRE	Maximum strain increment for subincrementation. If left blank, a default value is set during initialization based upon the shear strength and stiffness.
IRATE	Rate effects options: EQ.0: Rate effects model turned off (default). EQ.1: Rate effects model turned on.
ERODE	Elements erode when damage exceeds 0.99 and the maximum principal strain exceeds ERODE – 1.0. For erosion that is independent of strain, set ERODE equal to 1.0. Erosion does not occur if ERODE is less than 1.0.

VARIABLE

DESCRIPTION

RECOV

The modulus is recovered in compression when RECOV is equal to 0.0 (default). The modulus remains at the brittle damage level when RECOV is equal to 1.0. Partial recovery is modeled for values of RECOV between 0.0 and 1.0. Two options are available:

1. If RECOV is a value between 0.0 and 1.0, then recovery is based upon the sign of the pressure invariant only.
2. If RECOV is a value between 10.0 and 11.0, then recovery is based upon the sign of both the pressure and volumetric strain. In this case, RECOV = RECOV – 10, and a flag is set to request the volumetric strain check.

IRETRC

Cap retraction option:

EQ.0: Cap does not retract (default).

EQ.1: Cap retracts.

Card 2	1	2	3	4	5	6	7	8
Variable	PRED							
Type	F							

VARIABLE

DESCRIPTION

PRED

Pre-existing damage ($0 \leq \text{PRED} < 1$). If left blank, the default is zero (no pre-existing damage).

Concrete Properties Card. This card is included if and only if the CONCRETE keyword option is used.

Card 3	1	2	3	4	5	6	7	8
Variable	FPC	DAGG	UNITS					
Type	F	F	I					

VARIABLE	DESCRIPTION
FPC	Unconfined compression strength, f'_c . Material parameters are internally fit to data for unconfined compression strengths between about 20 and 58 MPa (2,901 to 8,412 psi), with emphasis on the mid-range between 28 and 48 MPa (4,061 and 6,962 psi). If left blank, the default for FPC is 30 MPa.
DAGG	Maximum aggregate size, D_{agg} . Softening is fit to data for aggregate sizes between 8 and 32 mm (0.3 and 1.3 inches). If left blank, the default for DAGG is 19 mm (3/4 inch).
UNITS	Units options: EQ.0: GPa, mm, msec, kg/mm ³ , kN EQ.1: MPa, mm, msec, g/mm ³ , N EQ.2: MPa, mm, sec, Mg/mm ³ , N EQ.3: Psi, inch, sec, lbf-s ² /in ⁴ , lbf EQ.4: Pa, m, sec, kg/m ³ , N

User Defined Properties Card. This card is included if and only if the keyword option is left blank.

Card 4	1	2	3	4	5	6	7	8
Variable	G	K	ALPHA	THETA	LAMBDA	BETA	NH	CH
Type	F	F	F	F	F	F	F	F

VARIABLE	DESCRIPTION
G	Shear modulus
K	Bulk modulus
ALPHA	Tri-axial compression surface constant term, α
THETA	Tri-axial compression surface linear term, θ
LAMBDA	Tri-axial compression surface nonlinear term, λ
BETA	Tri-axial compression surface exponent, β
NH	Hardening initiation, N_H

VARIABLE	DESCRIPTION
CH	Hardening rate, C_H

User Defined Properties Card. This card is included if and only if the keyword option is left blank.

Card 5	1	2	3	4	5	6	7	8
Variable	ALPHA1	THETA1	LAMBDA1	BETA1	ALPHA2	THETA2	LAMBDA2	BETA2
Type	F	F	F	F	F	F	F	F

VARIABLE	DESCRIPTION
ALPHA1	Torsion surface constant term, α_1
THETA1	Torsion surface linear term, θ_1
LAMBDA1	Torsion surface nonlinear term, λ_1
BETA1	Torsion surface exponent, β_1
ALPHA2	Tri-axial extension surface constant term, α_2
THETA2	Tri-axial extension surface linear term, θ_2
LAMBDA2	Tri-axial extension surface nonlinear term, λ_2
BETA2	Tri-axial extension surface exponent, β_2

User Defined Properties Card. This card is included if and only if the keyword option is left blank.

Card 6	1	2	3	4	5	6	7	8
Variable	R	X0	W	D1	D2			
Type	F	F	F	F	F			

VARIABLE	DESCRIPTION
R	Cap aspect ratio, R

VARIABLE	DESCRIPTION
X0	Cap initial location, X_0
W	Maximum plastic volume compaction, W
D1	Linear shape parameter, D_1
D2	Quadratic shape parameter, D_2

User Defined Properties Card. This card is included if and only if the keyword option is left blank.

Card 7	1	2	3	4	5	6	7	8
Variable	B	GFC	D	GFT	GFS	PWRC	PWRT	PMOD
Type	F	F	F	F	F	F	F	F

VARIABLE	DESCRIPTION
B	Ductile shape softening parameter, B
GFC	Fracture energy in uniaxial stress, G_{fc}
D	Brittle shape softening parameter, D
GFT	Fracture energy in uniaxial tension, G_{ft}
GFS	Fracture energy in pure shear stress, G_{fs}
PWRC	Shear-to-compression transition parameter
PWRT	Shear-to-tension transition parameter
PMOD	Modify moderate pressure softening parameter

User Defined Properties Card. This card is included if and only if the keyword option is left blank.

Card 8	1	2	3	4	5	6	7	8
Variable	ETA0C	NC	ETA0T	NT	OVERC	OVERT	SRATE	REPOW
Type	F	F	F	F	F	F	F	F

VARIABLE**DESCRIPTION**

ETA0C	Rate effects parameter for uniaxial compressive stress, η_{0c}
NC	Rate effects power for uniaxial compressive stress, N_c
ETA0T	Rate effects parameter for uniaxial tensile stress, η_{0t}
NT	Rate effects power for uniaxial tensile stress, N_t
OVERC	Maximum overstress allowed in compression
OVERT	Maximum overstress allowed in tension
SRATE	Ratio of effective shear stress to tensile stress fluidity parameters
REPOW	Power which increases fracture energy with rate effects

Remarks:

1. **Model Overview.** This is a cap model with a smooth intersection between the shear yield surface and hardening cap, as shown in [Figure M159-1](#). The initial damage surface coincides with the yield surface. Rate effects are modeled with viscoplasticity. For a complete theoretical description, with references and example problems see [Murray 2007] and [Murray, Abu-Odeh and Bligh 2007].
2. **Stress Invariants.** The yield surface is formulated in terms of three stress invariants: J_1 which is the first invariant of the stress tensor, J_2' which is the second invariant of the deviatoric stress tensor, and J_3' which is the third invariant of the deviatoric stress tensor. The invariants are defined in terms of the deviatoric stress tensor, S_{ij} , and pressure, P , as follows:

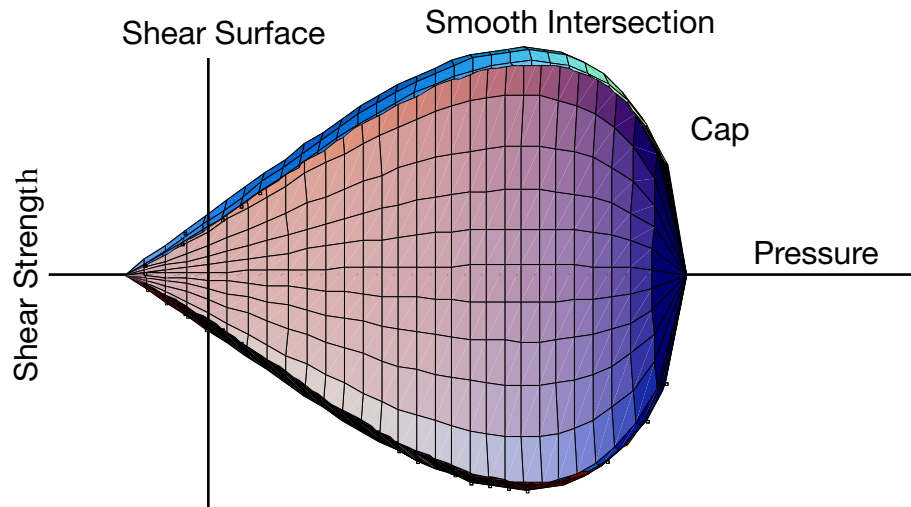

Figure M159-1. General shape of concrete model yield surface in two dimensions.

$$J_1 = 3P$$

$$J'_2 = \frac{1}{2} S_{ij} S_{ij}$$

$$J'_3 = \frac{1}{3} S_{ij} S_{ik} S_{ki}$$

3. **Plasticity Surface.** The three invariant yield function is based on these three invariants, and the cap hardening parameter, κ , as follows:

$$f(J_1, J'_2, J'_3, \kappa) = J'_2 - \mathfrak{R}^2 F_f^2 F_c .$$

Here F_f is the shear failure surface, F_c is the hardening cap, and \mathfrak{R} is the Rubin three-invariant reduction factor. The cap hardening parameter κ is the value of the pressure invariant at the intersection of the cap and shear surfaces.

Trial elastic stress invariants are temporarily updated using the trial elastic stress tensor, σ^T . These are denoted J_1^T, J_2^T , and J_3^T . Elastic stress states are modeled when $f(J_1^T, J_2^T, J_3^T, \kappa^T) \leq 0$. Elastic-plastic stress states are modeled when $f(J_1^T, J_2^T, J_3^T, \kappa^T) > 0$. In this case, the plasticity algorithm returns the stress state to the yield surface such that $f(J_1^P, J_2^P, J_3^P, \kappa^P) = 0$. This is accomplished by enforcing the plastic consistency condition with associated flow.

4. **Shear Failure Surface.** The strength of concrete is modeled by the shear surface in the tensile and low confining pressure regimes:

$$F_f(J_1) = \alpha - \lambda \exp(-\beta J_1) + \theta J_1 .$$

Here the values of α , β , λ , and θ are selected by fitting the model surface to strength measurements from triaxial compression (TXC) tests conducted on plain concrete cylinders.

5. **Rubin Scaling Function.** Concrete fails at lower values of $\sqrt{3J'_2}$ (principal stress difference) for triaxial extension (TXE) and torsion (TOR) tests than it does for TXC tests conducted at the same pressure. The Rubin scaling function, \mathfrak{R} , determines the strength of concrete for any state of stress relative to the strength for TXC, using $\mathfrak{R}F_f$. Strength in torsion is modeled as Q_1F_f . Strength in TXE is modeled as Q_2F_f , where:

$$Q_1 = \alpha_1 - \lambda_1 \exp(-\beta_1 J_1) + \theta_1 J_1$$

$$Q_2 = \alpha_2 - \lambda_2 \exp(-\beta_2 J_1) + \theta_2 J_1$$

6. **Cap Hardening Surface.** The strength of concrete is modeled by a combination of the cap and shear surfaces in the low to high confining pressure regimes. The cap is used to model plastic volume change related to pore collapse (although the pores are not explicitly modeled). The isotropic hardening cap is a two-part function that is either unity or an ellipse:

$$F_c(J_1, \kappa) = 1 - \frac{[J_1 - L(\kappa)][|J_1 - L(\kappa)| + J_1 - L(\kappa)]}{2 [X(\kappa) - L(\kappa)]^2},$$

where $L(\kappa)$ is defined as:

$$L(\kappa) = \begin{cases} \kappa & \text{if } \kappa > \kappa_0 \\ \kappa_0 & \text{otherwise} \end{cases}$$

The equation for F_c is equal to unity for $J_1 \leq L(\kappa)$. It describes the ellipse for $J_1 > L(\kappa)$. The intersection of the shear surface and the cap is at $J_1 = \kappa$. κ_0 is the value of J_1 at the *initial* intersection of the cap and shear surfaces before hardening is engaged (before the cap moves). The equation for $L(\kappa)$ restrains the cap from retracting past its initial location at κ_0 .

The intersection of the cap with the J_1 axis is at $J_1 = X(\kappa)$. This intersection depends upon the cap ellipticity ratio R , where R is the ratio of its major to minor axes:

$$X(\kappa) = L(\kappa) + RF_f[L(\kappa)].$$

The cap moves to simulate plastic volume change. The cap expands ($X(\kappa)$ and κ increase) to simulate plastic volume compaction. The cap contracts ($X(\kappa)$ and κ decrease) to simulate plastic volume expansion, called dilation. The motion (expansion and contraction) of the cap is based upon the hardening rule:

$$\varepsilon_v^p = W \left[1 - e^{-D_1(X-X_0) - D_2(X-X_0)^2} \right].$$

Here ε_v^p is the plastic volume strain, W is the maximum plastic volume strain, and D_1 and D_2 are model input parameters. X_0 is the initial location of the cap when $\kappa = \kappa_0$.

The five input parameters (X_0 , W , D_1 , D_2 , and R) are obtained from fits to the pressure-volumetric strain curves in isotropic compression and uniaxial strain. X_0 determines the pressure at which compaction initiates in isotropic

compression. R , combined with X_0 , determines the pressure at which compaction initiates in uniaxial strain. D_1 and D_2 determine the shape of the pressure-volumetric strain curves. W determines the maximum plastic volume compaction.

7. **Shear Hardening Surface.** In unconfined compression, the stress-strain behavior of concrete exhibits nonlinearity and dilation prior to the peak. Such behavior is modeled with an initial shear yield surface, $N_H F_f$, which hardens until it coincides with the ultimate shear yield surface, F_f . Two input parameters are required. One parameter, N_H , initiates hardening by setting the location of the initial yield surface. A second parameter, C_H , determines the rate of hardening (amount of nonlinearity).
8. **Damage.** Concrete exhibits softening in the tensile and low to moderate compressive regimes.

$$\sigma_{ij}^d = (1 - d)\sigma_{ij}^{VP}$$

A scalar damage parameter, d , transforms the viscoplastic stress tensor without damage, denoted σ^{VP} , into the stress tensor with damage, denoted σ^d . Damage accumulation is based upon two distinct formulations, which we call brittle damage and ductile damage. The initial damage threshold is coincident with the shear plasticity surface, so the threshold does not have to be specified by the user.

- a) *Ductile Damage.* Ductile damage accumulates when the pressure, P , is compressive and an energy-type term, τ_c , exceeds the damage threshold, τ_{0c} . Ductile damage accumulation depends upon the total strain components, ε_{ij} , as follows:

$$\tau_c = \sqrt{\frac{1}{2} \sigma_{ij} \varepsilon_{ij}}$$

The stress components, σ_{ij} are the elasto-plastic stresses (with kinematic hardening) calculated before application of damage and rate effects.

- b) *Brittle Damage.* Brittle damage accumulates when the pressure is tensile and an energy-type term, τ_t , exceeds the damage threshold, τ_{0t} . Brittle damage accumulation depends upon the maximum principal strain, ε_{\max} , as follows:

$$\tau_t = \sqrt{E \varepsilon_{\max}^2} .$$

As damage accumulates, the damage parameter, d , increases from an initial value of zero, towards a maximum value of one, using the following formulations:

$$\begin{aligned} \text{Brittle Damage: } d(\tau_t) &= \frac{0.999}{D} \left[\frac{1 + D}{1 + D e^{-C(\tau_t - \tau_{0t})}} - 1 \right] \\ \text{Ductile Damage: } d(\tau_c) &= \frac{d_{\max}}{B} \left[\frac{1 + B}{1 + B e^{-A(\tau_c - \tau_{0c})}} - 1 \right] \end{aligned}$$

The damage parameter that is applied to the six stresses is equal to the current maximum of the brittle or ductile damage parameter. The parameters A and B or C and D set the shape of the softening curve plotted as stress-displacement or stress-strain. The parameter d_{\max} is the maximum damage level that can be attained. It is internally calculated and is less than one at moderate confining pressures. See [Murray 2007] for a description of how d_{\max} is calculated for different loading regimes. The compressive softening parameter, A , may also be reduced with confinement, using the input field PMOD, as follows:

$$A = A(d_{\max} + 0.001)^{\text{PMOD}}$$

9. **Regulating Mesh Size Sensitivity.** The concrete model maintains constant fracture energy, regardless of element size. The fracture energy is defined here as the area under the stress-displacement curve from peak strength to zero strength. This is done by internally formulating the softening parameters A and C (see [Remark 8](#)) in terms of the element length, l (cube root of the element volume), the fracture energy, G_f , the initial damage threshold, τ_{0t} or τ_{0c} , and the softening shape parameters, D or B .

The fracture energy is calculated from up to five user-specified input fields: GFC, GFS, GFT, PWRC, and PWRT. The user specifies three distinct fracture energy values. These are the fracture energy in uniaxial tensile stress, GFT; pure shear stress, GFS; and uniaxial compressive stress, GFC. The model internally selects the fracture energy from equations which interpolate between the three fracture energy values as a function of the stress state (expressed using two stress invariants). The interpolation equations depend upon the user-specified input powers PWRC and PWRT, as follows:

$$\begin{aligned} \text{Tensile Pressure: } G_f &= \text{GFS} + \left(\frac{-J_1}{\sqrt{3J_2'}} \right)^{\overbrace{k_t}^{\text{PWRT}}} [\text{GFT} - \text{GFS}] \\ \text{Compressive Pressure: } G_f &= \text{GFS} + \left(\frac{J_1}{\sqrt{3J_2'}} \right)^{\overbrace{k_c}^{\text{PWRC}}} [\text{GFC} - \text{GFS}] \end{aligned}$$

The internal parameters k_c and k_t are restricted to the interval $[0,1]$.

10. **Element Erosion.** An element loses all strength and stiffness as $d \rightarrow 1$. To prevent computational difficulties with very low stiffness, element erosion is

available as a user option. An element erodes when $d > 0.99$ and the maximum principal strain is greater than a user supplied input value, ERODE – 1.0.

11. **Viscoplastic Rate Effects.** At each time step, the viscoplastic algorithm interpolates between the elastic trial stress, σ_{ij}^T , and the inviscid stress (without rate effects), σ_{ij}^P , to set the viscoplastic stress (with rate effects), σ_{ij}^{VP} :

$$\sigma_{ij}^{VP} = (1 - \gamma)\sigma_{ij}^T + \gamma\sigma_{ij}^P,$$

where

$$\gamma = \frac{\Delta t / \eta}{1 + \Delta t / \eta}.$$

This interpolation depends upon the effective fluidity coefficient, η , and the time step, Δt . The effective fluidity coefficient is internally calculated from five user-supplied input parameters and interpolation equations:

$$\begin{aligned} \text{Tensile Pressure: } \eta &= \eta_s + \left(\frac{-J_1}{\sqrt{3J_2'}} \right)^{\text{PWRT}} [\eta_t - \eta_s] \\ \text{Compressive Pressure: } \eta &= \eta_s + \left(\frac{J_1}{\sqrt{3J_2'}} \right)^{\text{PWRC}} [\eta_c - \eta_s] \end{aligned}$$

where

$$\begin{aligned} \eta_s &= \text{SRATE} \times \eta_t \\ \eta_t &= \frac{\text{ETA0T}}{\dot{\epsilon}^{\text{NT}}} \\ \eta_c &= \frac{\text{ETA0C}}{\dot{\epsilon}^{\text{NC}}} \end{aligned}$$

The input parameters are ETA0T and NT for fitting uniaxial tensile stress data, ETA0X and NC for fitting the uniaxial compressive stress data, and SRATE for fitting shear stress data. The effective strain rate is $\dot{\epsilon}$.

This viscoplastic model may predict substantial rate effects at high strain rates ($\dot{\epsilon} > 100$). To limit rate effects at high strain rates, the user may input overstress limits in tension OVERT and compression OVERC. These input fields limit calculation of the fluidity parameter, as follows:

$$\text{if } E\dot{\epsilon}\eta > \text{OVER}, \text{ then } \eta = \frac{m}{E\dot{\epsilon}}.$$

Here $m = \text{OVERT}$ when the pressure is tensile and $m = \text{OVERC}$ when the pressure is compressive.

The user has the option of increasing the fracture energy as a function of effective strain rate using the REPOW input parameter, as follows:

$$G_f^{\text{rate}} = G_f \left[1 + \frac{E \dot{\epsilon} \eta}{r^s \sqrt{E}} \right]^{\text{REPOW}}$$

Here G_f^{rate} is the fracture energy enhanced by rate effects, and r^s is an internally calculated damage threshold determined before applying viscoplasticity (see [Murray 2007] for more details). The term in brackets is only applied if it is greater than or equal to one and is the approximate ratio of the dynamic to static strength.

***MAT_ALE_INCOMPRESSIBLE**

This is Material Type 160. This material is for modeling incompressible flows with the ALE solver. It should be used with solid element formulations 6 or 12 (see *SECTION_SOLID). A projection method enforces the incompressibility condition.

Card 1	1	2	3	4	5	6	7	8
Variable	MID	RO	PC	MU				
Type	A	F	F	F				
Default	none	none	0.0	0.0				

Card 2	1	2	3	4	5	6	7	8
Variable	TOL	DTOUT	NCG	METH				
Type	F	F	I	I				
Default	10 ⁻⁸	10 ¹⁰	50	-7				

VARIABLE**DESCRIPTION**

MID	Material identification. A unique number or label must be specified (see *PART)
RO	Material density
PC	Pressure cutoff (≤ 0.0)
MU	Dynamic viscosity coefficient
TOL	Tolerance for the convergence of the conjugate gradient
DTOUT	Time interval between screen outputs
NCG	Maximum number of loops in the conjugate gradient
METH	Conjugate gradient methods: EQ.-6: Solves Poisson's equation for the pressure.

VARIABLE**DESCRIPTION**

EQ.-7: Solves Poisson's equation for the pressure increment.

*MAT_COMPOSITE_MSC_{OPTION}

Available options include:

<BLANK>

DMG

These are Material Types 161 and 162. These models may be used to model the progressive failure analysis for composite materials consisting of unidirectional and woven fabric layers. The progressive layer failure criteria have been established by adopting the methodology developed by Hashin [1980] with a generalization to include the effect of highly constrained pressure on composite failure. These failure models can be used to effectively simulate fiber failure, matrix damage, and delamination behavior under all conditions - opening, closing, and sliding of failure surfaces. The model with the DMG keyword option (material 162) is a generalization of the basic layer failure model of Material 161 by adopting the damage mechanics approach for characterizing the softening behavior after damage initiation. These models require an additional license from Materials Sciences Corporation, which developed and supports these models. These models are supported for solid elements.

Card Summary:

Card 1. This card is required.

MID	RO	EA	EB	EC	PRBA	PRCA	PRCB
-----	----	----	----	----	------	------	------

Card 2. This card is required.

GAB	GBC	GCA	AOPT	MACF			
-----	-----	-----	------	------	--	--	--

Card 3. This card is required.

XP	YP	ZP	A1	A2	A3		
----	----	----	----	----	----	--	--

Card 4. This card is required.

V1	V2	V3	D1	D2	D3	BETA	
----	----	----	----	----	----	------	--

Card 5. This card is required.

SAT	SAC	SBT	SBC	SCT	SFC	SFS	SAB
-----	-----	-----	-----	-----	-----	-----	-----

Card 6. This card is required.

SBC	SCA	SFFC	AMODEL	PHIC	E_LIMIT	S_DELM	
-----	-----	------	--------	------	---------	--------	--

Card 7. This card is required.

OMGMX	ECRSH	EEXPN	CERATE1	AM1			
-------	-------	-------	---------	-----	--	--	--

Card 8. This card is included if the DMG keyword option is used.

AM2	AM3	AM4	CERATE2	CERATE3	CERATE4		
-----	-----	-----	---------	---------	---------	--	--

Data Card Definitions:

Card 1	1	2	3	4	5	6	7	8
Variable	MID	RO	EA	EB	EC	PRBA	PRCA	PRCB
Type	A	F	F	F	F	F	F	F

VARIABLE

DESCRIPTION

MID	Material ID. A unique number or label must be specified (see *PART).
RO	Mass density
EA	E_a , Young's modulus - longitudinal direction
EB	E_b , Young's modulus - transverse direction
EC	E_c , Young's modulus - through thickness direction
PRBA	ν_{ba} , Poisson's ratio ba
PRCA	ν_{ca} , Poisson's ratio ca
PRCB	ν_{cb} , Poisson's ratio cb

Card 2	1	2	3	4	5	6	7	8
Variable	GAB	GBC	GCA	AOPT	MACF			
Type	F	F	F	F	I			

VARIABLE	DESCRIPTION
GAB	G_{ab} , shear modulus ab
GBC	G_{bc} , shear modulus bc
GCA	G_{ca} , shear modulus ca
AOPT	<p>Material axes option (see MAT_OPTIONTROPIC_ELASTIC, particularly the Material Directions section, for details):</p> <p>EQ.0.0: Locally orthotropic with material axes determined by element nodes 1, 2, and 4, as with *DEFINE_COORDINATE_NODES..</p> <p>EQ.1.0: Locally orthotropic with material axes determined by a point, P, in space and the global location of the element center; this is the \mathbf{a}-direction.</p> <p>EQ.2.0: Globally orthotropic with material axes determined by vectors defined below, as with *DEFINE_COORDINATE_VECTOR</p> <p>EQ.3.0: Locally orthotropic material axes determined by a vector \mathbf{v} and the normal vector to the plane of the element. The plane of a solid element is the midsurface between the inner surface and outer surface defined by the first four nodes and the last four nodes of the connectivity of the element, respectively. Thus, AOPT = 3 is only available for hexahedrons. \mathbf{a} is determined by taking the cross product of \mathbf{v} with the normal vector, \mathbf{b} is determined by taking the cross product of the normal vector with \mathbf{a}, and \mathbf{c} is the normal vector. Then \mathbf{a} and \mathbf{b} are rotated about \mathbf{c} by an angle BETA. BETA may be set in the keyword input for the element or in the input for this keyword. Note that the material axes may be switched depending on the choice of MACF. The switch may occur before or after applying BETA depending on the value of MACF.</p> <p>EQ.4.0: Locally orthotropic in a cylindrical coordinate system with the material axes determined by a vector \mathbf{v}, and an originating point, P, which define the centerline axis.</p> <p>LT.0.0: The absolute value of AOPT is a coordinate system ID number (CID on *DEFINE_COORDINATE_OPTION).</p>

VARIABLE	DESCRIPTION
-----------------	--------------------

MACF Material axes change flag for solid elements:

EQ.-4: Switch material axes *b* and *c* before BETA rotation

EQ.-3: Switch material axes *a* and *c* before BETA rotation

EQ.-2: Switch material axes *a* and *b* before BETA rotation

EQ.1: No change, default

EQ.2: Switch material axes *a* and *b* after BETA rotation

EQ.3: Switch material axes *a* and *c* after BETA rotation

EQ.4: Switch material axes *b* and *c* after BETA rotation

Figure M2-2 indicates when LS-DYNA applies MACF during the process to obtain the final material axes. If BETA on *ELEMENT_-SOLID_{OPTION} is defined, then that BETA is used for the rotation for all AOPT options. Otherwise, if AOPT = 3, the BETA input on Card 4 rotates the axes. For all other values of AOPT, the material axes will be switched as specified by MACF, but no BETA rotation will be performed.

Card 3	1	2	3	4	5	6	7	8
Variable	XP	YP	ZP	A1	A2	A3		
Type	F	F	F	F	F	F		

VARIABLE	DESCRIPTION
-----------------	--------------------

XP, YP, ZP Coordinates of point *p* for AOPT = 1 and 4

A1, A2, A3 Components of vector **a** for AOPT = 2

Card 4	1	2	3	4	5	6	7	8
Variable	V1	V2	V3	D1	D2	D3	BETA	
Type	F	F	F	F	F	F	F	

VARIABLE	DESCRIPTION							
V1, V2, V3	Components of vector v for AOPT = 3 and 4							
D1, D2, D3	Components of vector d for AOPT = 2							
BETA	Layer in-plane rotational angle in degrees. It may be override							

Card 5	1	2	3	4	5	6	7	8
Variable	SAT	SAC	SBT	SBC	SCT	SFC	SFS	SAB
Type	F	F	F	F	F	F	F	F

VARIABLE	DESCRIPTION							
SAT	Longitudinal tensile strength							
SAC	Longitudinal compressive strength							
SBT	Transverse tensile strength							
SBC	Transverse compressive strength							
SCT	Through thickness tensile strength							
SFC	Crush strength							
SFS	Fiber mode shear strength							
SAB	Matrix mode shear strength, <i>ab</i> plane; see remarks.							

Card 6	1	2	3	4	5	6	7	8
Variable	SBC	SCA	SFFC	AMODEL	PHIC	E_LIMT	S_DELM	
Type	F	F	F	F	F	F	F	

VARIABLE	DESCRIPTION							
SBC	Matrix mode shear strength, <i>bc</i> plane; see remarks.							
SCA	Matrix mode shear strength, <i>ca</i> plane; see remarks.							

VARIABLE	DESCRIPTION
SFFC	Scale factor for residual compressive strength
AMODEL	Material models: EQ.1.0: Unidirectional layer model EQ.2.0: Fabric layer model
PHIC	Coulomb friction angle for matrix and delamination failure, < 90
E_LIMT	Element eroding axial strain
S_DELM	Scale factor for delamination criterion

Card 7	1	2	3	4	5	6	7	8
Variable	OMGMX	ECRSH	EEXPAN	CERATE1	AM1			
Type	F	F	F	F	F			

VARIABLE	DESCRIPTION
OMGMX	Limit damage parameter for elastic modulus reduction
ECRSH	Limit compressive volume strain for element eroding
EEXPAN	Limit tensile volume strain for element eroding
CERATE1	Coefficient for strain rate dependent strength properties
AM1	Coefficient for strain rate softening property for fiber damage in <i>a</i> -direction

Failure Card. Additional card for DMG keyword option.

Card 8	1	2	3	4	5	6	7	8
Variable	AM2	AM3	AM4	CERATE2	CERATE3	CERATE4		
Type	F	F	F	F	F	F		

VARIABLE	DESCRIPTION
AM2	Coefficient for strain rate softening property for fiber damage in b -direction
AM3	Coefficient for strain rate softening property for fiber crush and punch shear damage
AM4	Coefficient for strain rate softening property for matrix and delamination damage
CERATE2	Coefficient for strain rate dependent axial moduli
CERATE3	Coefficient for strain rate dependent shear moduli
CERATE4	Coefficient for strain rate dependent transverse moduli

Material Models:

The unidirectional and fabric layer failure criteria and the associated property degradation models for material 161 are described as follows. All the failure criteria are expressed in terms of stress components based on ply level stresses ($\sigma_a, \sigma_b, \sigma_c, \tau_{ab}, \tau_{bc}, \tau_{ca}$) and the associated elastic moduli are ($E_a, E_b, E_c, G_{ab}, G_{bc}, G_{ca}$). Note that for the unidirectional model, a, b and c denote the fiber, in-plane transverse and out-of-plane directions, respectively, while for the fabric model, a, b and c denote the in-plane fill, in-plane warp and out-of-plane directions, respectively.

Unidirectional Lamina Model:

Three criteria are used for fiber failure, one in tension/shear, one in compression and another one in crush under pressure. They are chosen in terms of quadratic stress forms as follows:

1. Tensile/shear fiber mode:

$$f_1 = \left(\frac{\langle \sigma_a \rangle}{S_{aT}} \right)^2 + \left(\frac{\tau_{ab}^2 + \tau_{ca}^2}{S_{FS}^2} \right) - 1 = 0$$

2. Compression fiber mode:

$$f_2 = \left(\frac{\langle \sigma'_a \rangle}{S_{aC}} \right)^2 - 1 = 0, \quad \sigma'_a = -\sigma_a + \left\langle -\frac{\sigma_b + \sigma_c}{2} \right\rangle$$

3. Crush mode:

$$f_3 = \left(\frac{\langle p \rangle}{S_{FC}} \right)^2 - 1 = 0, \quad p = -\frac{\sigma_a + \sigma_b + \sigma_c}{3}$$

Here $\langle \ \rangle$ are Macaulay brackets, S_{aT} and S_{aC} are the tensile and compressive strengths in the fiber direction, and S_{FS} and S_{FC} are the layer strengths associated with the fiber shear and crush failure, respectively.

Matrix mode failures must occur without fiber failure, and hence they will be on planes parallel to fibers. For simplicity, only two failure planes are considered: one is perpendicular to the planes of layering and the other one is parallel to them. The matrix failure criteria for the failure plane perpendicular and parallel to the layering planes, respectively, have the forms:

1. Perpendicular matrix mode:

$$f_4 = \left(\frac{\langle \sigma_b \rangle}{S_{bT}} \right)^2 + \left(\frac{\tau_{bc}}{S'_{bc}} \right)^2 + \left(\frac{\tau_{ab}}{S_{ab}} \right)^2 - 1 = 0$$

2. Parallel matrix mode (Delamination):

$$f_5 = S^2 \left\{ \left(\frac{\langle \sigma_c \rangle}{S_{bT}} \right)^2 + \left(\frac{\tau_{bc}}{S''_{bc}} \right)^2 + \left(\frac{\tau_{ca}}{S_{ca}} \right)^2 \right\} - 1 = 0$$

Here S_{bT} is the transverse tensile strength. Based on the Coulomb-Mohr theory, the shear strengths for the transverse shear failure and the two axial shear failure modes are assumed to be the forms,

$$\begin{aligned} S_{ab} &= S_{ab}^{(0)} + \tan(\varphi) \langle -\sigma_b \rangle \\ S'_{bc} &= S_{bc}^{(0)} + \tan(\varphi) \langle -\sigma_b \rangle \\ S_{ca} &= S_{ca}^{(0)} + \tan(\varphi) \langle -\sigma_c \rangle \\ S''_{bc} &= S_{bc}^{(0)} + \tan(\varphi) \langle -\sigma_c \rangle \end{aligned}$$

where φ is a material constant as $\tan(\varphi)$ is similar to the coefficient of friction, and $S_{ab}^{(0)}$, $S_{ca}^{(0)}$ and $S_{bc}^{(0)}$ are the shear strength values of the corresponding tensile modes.

Failure predicted by the criterion of f_4 can be referred to as transverse matrix failure, while the matrix failure predicted by f_5 , which is parallel to the layer, can be referred as the delamination mode when it occurs within the elements that are adjacent to the ply interface. Note that a scale factor S is introduced to provide better correlation of delamination area with experiments. The scale factor S can be determined by fitting the analytical prediction to experimental data for the delamination area.

When fiber failure in tension/shear mode is predicted in a layer by f_1 , the load carrying capacity of that layer is completely eliminated. All the stress components are reduced to zero instantaneously (100 time steps to avoid numerical instability). For compressive fiber failure, the layer is assumed to carry a residual axial load, while the transverse load carrying capacity is reduced to zero. When the fiber compressive failure mode is reached due to f_2 , the axial layer compressive strength stress is assumed to reduce to a residual value S_{RC} ($= S_{FFC} \times S_{AC}$). The axial stress is then assumed to remain constant, meaning

$\sigma_a = -S_{RC}$, for continuous compressive loading, while the subsequent unloading curve follows a reduced axial modulus to zero axial stress and strain state. When the fiber crush failure occurs, the material is assumed to behave elastically for compressive pressure, $p > 0$, and to carry no load for tensile pressure, $p < 0$.

When a matrix failure (delamination) in the ab -plane is predicted, the strength values for $S_{ca}^{(0)}$ and $S_{bc}^{(0)}$ are set to zero. This results in reducing the stress components σ_c , τ_{bc} and τ_{ca} to the fractured material strength surface. For tensile mode, $\sigma_c > 0$, these stress components are reduced to zero. For compressive mode, $\sigma_c < 0$, the normal stress σ_c is assumed to deform elastically for the closed matrix crack. Loading on the failure envelop, the shear stresses are assumed to 'slide' on the fractured strength surface (frictional shear stresses) like in an ideal plastic material, while the subsequent unloading shear stress-strain path follows reduced shear moduli to the zero shear stress and strain state for both τ_{bc} and τ_{ca} components.

The post failure behavior for the matrix crack in the a - c plane due to f_4 is modeled in the same fashion as that in the ab -plane as described above. In this case, when failure occurs, $S_{ab}^{(0)}$ and $S_{bc}^{(0)}$ are reduced to zero instantaneously. The post fracture response is then governed by failure criterion of f_5 with $S_{ab}^{(0)} = 0$ and $S_{bc}^{(0)} = 0$. For tensile mode, $\sigma_b > 0$, σ_b , τ_{ab} and τ_{bc} are zero. For compressive mode, $\sigma_b < 0$, σ_b is assumed to be elastic, while τ_{ab} and τ_{bc} 'slide' on the fracture strength surface as in an ideal plastic material, and the unloading path follows reduced shear moduli to the zero shear stress and strain state. It should be noted that τ_{bc} is governed by both the failure functions and should lie within or on each of these two strength surfaces.

Fabric Lamina Model:

The fiber failure criteria of Hashin for a unidirectional layer are generalized to characterize the fiber damage in terms of strain components for a plain weave layer. The fill and warp fiber tensile/shear failure are given by the quadratic interaction between the associated axial and shear stresses, that is,

$$f_6 = \left(\frac{\langle \sigma_a \rangle}{S_{aT}} \right)^2 + \frac{(\tau_{ab}^2 + \tau_{ca}^2)}{S_{aFS}^2} - 1 = 0$$

$$f_7 = \left(\frac{\langle \sigma_b \rangle}{S_{bT}} \right)^2 + \frac{(\tau_{ab}^2 + \tau_{bc}^2)}{S_{bFS}^2} - 1 = 0$$

where S_{aT} and S_{bT} are the axial tensile strengths in the fill and warp directions, respectively, and S_{aFS} and S_{bFS} are the layer shear strengths due to fiber shear failure in the fill and warp directions. These failure criteria are applicable when the associated σ_a or σ_b is positive. It is assumed $S_{aFS} = SFS$, and

$$S_{bFS} = SFS \times \frac{S_{bT}}{S_{aT}} .$$

When σ_a or σ_b is compressive, it is assumed that the in-plane compressive failure in both the fill and warp directions are given by the maximum stress criterion, that is,

$$f_8 = \left[\frac{\langle \sigma'_a \rangle}{S_{aC}} \right]^2 - 1 = 0, \quad \sigma'_a = -\sigma_a + \langle -\sigma_c \rangle$$

$$f_9 = \left[\frac{\langle \sigma'_b \rangle}{S_{bC}} \right]^2 - 1 = 0, \quad \sigma'_b = -\sigma_b + \langle -\sigma_c \rangle$$

where S_{aC} and S_{bC} are the axial compressive strengths in the fill and warp directions, respectively. The crush failure under compressive pressure is

$$f_{10} = \left(\frac{\langle p \rangle}{S_{FC}} \right)^2 - 1 = 0, \quad p = -\frac{\sigma_a + \sigma_b + \sigma_c}{3}.$$

A plain weave layer can fail under in-plane shear stress without the occurrence of fiber breakage. This in-plane matrix failure mode is given by

$$f_{11} = \left(\frac{\tau_{ab}}{S_{ab}} \right)^2 - 1 = 0,$$

where S_{ab} is the layer shear strength due to matrix shear failure.

Another failure mode, which is due to the quadratic interaction between the thickness stresses, is expected to be mainly a matrix failure. This through the thickness matrix failure criterion is

$$f_{12} = S^2 \left\{ \left(\frac{\langle \sigma_c \rangle}{S_{cT}} \right)^2 + \left(\frac{\tau_{bc}}{S_{bc}} \right)^2 + \left(\frac{\tau_{ca}}{S_{ca}} \right)^2 \right\} - 1 = 0,$$

where S_{cT} is the through the thickness tensile strength, and S_{bc} and S_{ca} are the shear strengths assumed to depend on the compressive normal stress σ_c , meaning

$$\begin{Bmatrix} S_{ca} \\ S_{bc} \end{Bmatrix} = \begin{Bmatrix} S_{ca}^{(0)} \\ S_{bc}^{(0)} \end{Bmatrix} + \tan(\varphi) \langle -\sigma_c \rangle.$$

When failure predicted by this criterion occurs within elements that are adjacent to the ply interface, the failure plane is expected to be parallel to the layering planes, and, thus, can be referred to as the delamination mode. Note that a scale factor S is introduced to provide better correlation of delamination area with experiments. The scale factor S can be determined by fitting the analytical prediction to experimental data for the delamination area.

Similar to the unidirectional model, when fiber tensile/shear failure is predicted in a layer by f_6 or f_7 , the load carrying capacity of that layer in the associated direction is completely eliminated. For compressive fiber failure due to by f_8 or f_9 , the layer is assumed to carry a residual axial load in the failed direction, while the load carrying capacity transverse to the failed direction is assumed unchanged. When the compressive axial stress in a layer reaches the compressive axial strength S_{aC} or S_{bC} , the axial layer stress is assumed to be reduced to the residual strength S_{aRC} or S_{bRC} where $S_{aRC} = \text{SFFC} \times S_{aC}$ and $S_{bRC} =$

SFFC $\times S_{bc}$. The axial stress is assumed to remain constant, that is, $\sigma_a = -S_{aCR}$ or $\sigma_b = -S_{bCR}$, for continuous compressive loading, while the subsequent unloading curve follows a reduced axial modulus. When the fiber crush failure is occurred, the material is assumed to behave elastically for compressive pressure, $p > 0$, and to carry no load for tensile pressure, $p < 0$.

When the in-plane matrix shear failure is predicted by f_{11} the axial load carrying capacity within a failed element is assumed unchanged, while the in-plane shear stress is assumed to be reduced to zero.

For through the thickness matrix (delamination) failure given by equation f_{12} , the in-plane load carrying capacity within the element is assumed to be elastic, while the strength values for the tensile mode, $S_{ca}^{(0)}$ and $S_{bc}^{(0)}$, are set to zero. For tensile mode, $\sigma_c > 0$, the through the thickness stress components are reduced to zero. For compressive mode, $\sigma_c < 0$, σ_c is assumed to be elastic, while τ_{bc} and τ_{ca} 'slide' on the fracture strength surface as in an ideal plastic material, and the unloading path follows reduced shear moduli to the zero shear stress and strain state.

The effect of strain-rate on the layer strength values of the fiber failure modes is modeled by the strain-rate dependent functions for the strength values $\{S_{RT}\}$ as

$$\{S_{RT}\} = \{S_0\} \left(1 + C_{rate1} \ln \frac{\{\dot{\epsilon}\}}{\dot{\epsilon}_0} \right)$$

$$\{S_{RT}\} = \begin{Bmatrix} S_{aT} \\ S_{aC} \\ S_{bT} \\ S_{bC} \\ S_{FC} \\ S_{FS} \end{Bmatrix}, \quad \{\dot{\epsilon}\} = \begin{Bmatrix} |\dot{\epsilon}_a| \\ |\dot{\epsilon}_a| \\ |\dot{\epsilon}_b| \\ |\dot{\epsilon}_b| \\ |\dot{\epsilon}_c| \\ (\dot{\epsilon}_{ca}^2 + \dot{\epsilon}_{bc}^2)^{1/2} \end{Bmatrix}$$

where C_{rate1} is the strain-rate constants, and $\{S_0\}$ are the strength values of $\{S_{RT}\}$ at the reference strain-rate $\dot{\epsilon}_0$.

Damage Model:

The damage model is a generalization of the layer failure model of Material 161 by adopting the MLT damage mechanics approach, Matzenmiller et al. [1995], for characterizing the softening behavior after damage initiation. Complete model description is given in Yen [2002]. The damage functions, which are expressed in terms of ply level engineering strains, are converted from the above failure criteria of fiber and matrix failure modes by neglecting the Poisson's effect. Elastic moduli reduction is expressed in terms of the associated damage parameters ω_i :

$$E'_i = (1 - \omega_i)E_i$$

where ω_i is given by

$$\omega_i = 1 - \exp\left(-\frac{r_i^{m_i}}{m_i}\right), \quad r_i \geq 0, \quad i = 1, \dots, 6 .$$

In the above E_i are the initial elastic moduli, E'_i are the reduced elastic moduli, r_i are the damage thresholds computed from the associated damage functions for fiber damage, matrix damage and delamination, and m_i are material damage parameters, which are currently assumed to be independent of strain-rate. The damage function is formulated to account for the overall nonlinear elastic response of a lamina including the initial 'hardening' and the subsequent softening beyond the ultimate strengths.

In the damage model (material 162), the effect of strain-rate on the nonlinear stress-strain response of a composite layer is modeled by the strain-rate dependent functions for the elastic moduli $\{E_{RT}\}$ as

$$\{E_{RT}\} = \{E_0\} \left(1 + \{C_{rate}\} \ln \frac{\{\dot{\varepsilon}\}}{\dot{\varepsilon}_0} \right)$$

$$\{E_{RT}\} = \begin{Bmatrix} E_a \\ E_b \\ E_c \\ G_{ab} \\ G_{bc} \\ G_{ca} \end{Bmatrix} \quad \{\dot{\varepsilon}\} = \begin{Bmatrix} |\dot{\varepsilon}_a| \\ |\dot{\varepsilon}_b| \\ |\dot{\varepsilon}_c| \\ |\dot{\varepsilon}_{ab}| \\ |\dot{\varepsilon}_{bc}| \\ |\dot{\varepsilon}_{ca}| \end{Bmatrix} \quad \{C_{rate}\} = \begin{Bmatrix} C_{rate2} \\ C_{rate2} \\ C_{rate4} \\ C_{rate3} \\ C_{rate3} \\ C_{rate3} \end{Bmatrix}$$

where $\{C_{rate}\}$ are the strain-rate constants. $\{E_0\}$ are the modulus values of $\{E_{RT}\}$ at the reference strain-rate $\dot{\varepsilon}_0$.

Element Erosion:

A failed element is eroded in any of three different ways:

1. If fiber tensile failure in a unidirectional layer is predicted in the element and the axial tensile strain is greater than E_LIMT. For a fabric layer, both in-plane directions are failed and exceed E_LIMT.
2. If compressive relative volume in a failed element is smaller than ECRSH.
3. If tensile relative volume in a failed element is greater than EEXPN.

Damage History Parameters:

Information about the damage history variables for the associated failure modes can be plotted in LS-PrePost. These additional history variables are tabulated below:

History Variable	Description	Value	History Variable #
$efa(I)$	Fiber mode in a		7
$efb(I)$	Fiber mode in b		8
$efp(I)$	Fiber crush mode	EQ.0: elastic	9
$em(I)$	Perpendicular matrix mode	GE.1: failed	10
$ed(I)$	Parallel matrix/delamination mode		11
$delm(I)$	Delamination mode		12

***MAT_MODIFIED_CRUSHABLE_FOAM**

This is Material Type 163 which is dedicated to modeling crushable foam with optional damping, tension cutoff, and strain rate effects. Unloading is fully elastic. Tension is treated as elastic-perfectly-plastic at the tension cut-off value.

Card 1	1	2	3	4	5	6	7	8
Variable	MID	RO	E	PR	TID	TSC	DAMP	NCYCLE
Type	A	F	F	F	F	F	F	F
Default	none	none	none	none	none	0.0	0.10	12.

Card 2	1	2	3	4	5	6	7	8
Variable	SRCLMT	SFLAG						
Type	F	I						
Default	10 ²⁰	0						

VARIABLE**DESCRIPTION**

MID	Material identification. A unique number or label must be specified (see *PART).
RO	Mass density
E	Young's modulus
PR	Poisson's ratio
TID	Table ID defining yield stress as a function of volumetric strain, γ , at different strain rates.
TSC	Tensile stress cutoff. A nonzero, positive value is strongly recommended for realistic behavior.
DAMP	Rate sensitivity via damping coefficient (.05 < recommended value < .50).

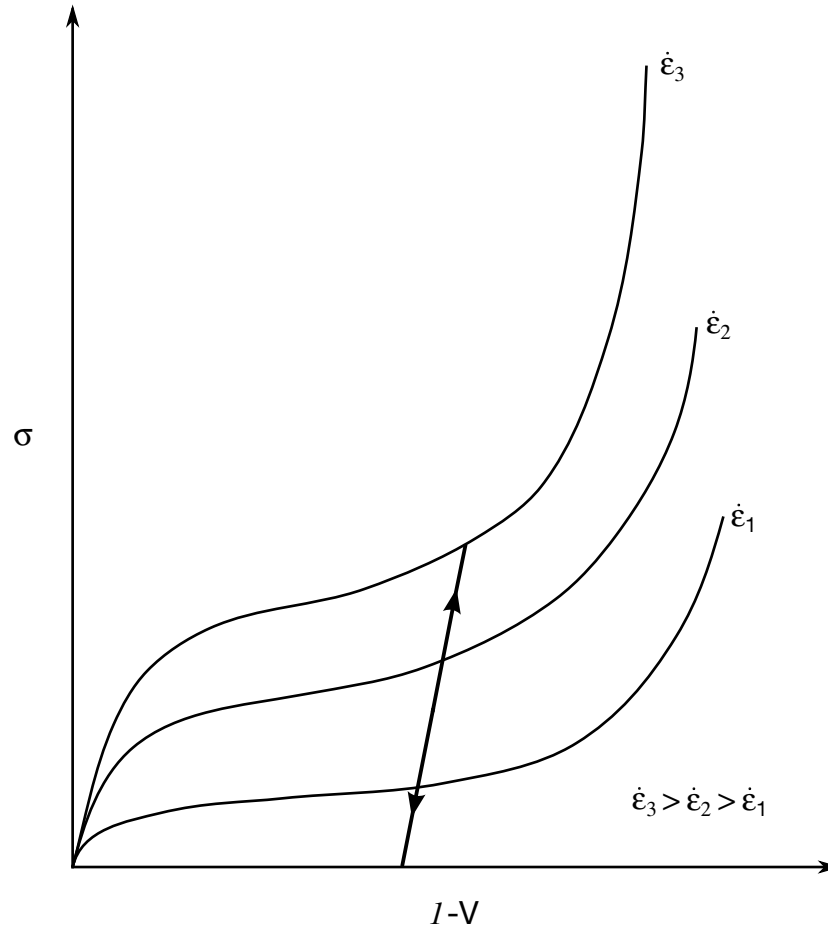

Figure M163-1. Rate effects are defined by a family of curves giving yield stress as a function of volumetric strain where V is the relative volume.

VARIABLE	DESCRIPTION
NCYCLE	Number of cycles to determine the average volumetric strain rate.
SRCLMT	Strain rate change limit.
SFLAG	The strain rate in the table may be the true strain rate (SFLAG = 0) or the engineering strain rate (SFLAG = 1).

Remarks:

The volumetric strain is defined in terms of the relative volume, V , as:

$$\gamma = 1 - V$$

The relative volume is defined as the ratio of the current to the initial volume. In place of the effective plastic strain in the d3plot database, the integrated volumetric strain is output.

This material is an extension of material 63, *MAT_CRUSHABLE_FOAM. It allows the yield stress to be a function of both volumetric strain rate and volumetric strain. Rate effects are accounted for by defining a table of curves using *DEFINE_TABLE. Each curve defines the yield stress as a function volumetric strain for a different strain rate. The yield stress is obtained by interpolating between the two curves that bound the strain rate.

To prevent high frequency oscillations in the strain rate from causing similar high frequency oscillations in the yield stress, a modified volumetric strain rate is used when interpolating to obtain the yield stress. The modified strain rate is obtained as follows. If NYCLE is > 1 , then the modified strain rate is obtained by a time average of the actual strain rate over NCYCLE solution cycles. For SRCLMT > 0 , the modified strain rate is capped so that during each cycle, the modified strain rate is not permitted to change more than SRCLMT multiplied by the solution time step.

***MAT_BRAIN_LINEAR_VISCOELASTIC**

This is Material Type 164. This material is a Kelvin-Maxwell model for modeling brain tissue, which is valid for solid elements only. See Remarks below.

Card 1	1	2	3	4	5	6	7	8
Variable	MID	RO	BULK	G0	GI	DC	FO	S0
Type	A	F	F	F	F	F	F	F
Default	none	none	none	none	none	0.0	0.0	0.0

VARIABLE**DESCRIPTION**

MID	Material identification. A unique number or label must be specified (see *PART).
RO	Mass density
BULK	Bulk modulus (elastic)
G0	Short-time shear modulus, G_0
GI	Long-time (infinite) shear modulus, G_∞
DC	Constant depending on formulation option (FO) below: FO.EQ.0.0: Maxwell decay constant, β FO.EQ.1.0: Kelvin relaxation constant, τ
FO	Formulation option: EQ.0.0: Maxwell EQ.1.0: Kelvin
S0	Strain (logarithmic) output option to control what is written as component 7 to the d3plot database. (LS-PrePost always blindly labels this component as effective plastic strain.) The maximum values are updated for each element each time step: EQ.0.0: Maximum principal strain that occurs during the calculation

VARIABLE	DESCRIPTION
	EQ.1.0: Maximum magnitude of the principal strain values that occurs during the calculation
	EQ.2.0: Maximum effective strain that occurs during the calculation

Remarks:

1. **Maxwell Model.** The shear relaxation behavior is described for the Maxwell model by:

$$G(t) = G + (G_0 - G_\infty)e^{-\beta t} .$$

A Jaumann rate formulation is used

$$\overset{\nabla}{\sigma}_{ij} = 2 \int_0^t G(t - \tau) D'_{ij}(\tau) dt ,$$

where the prime denotes the deviatoric part of the stress rate, $\overset{\nabla}{\sigma}_{ij}$, and the strain rate D_{ij} .

2. **Kelvin Model.** For the Kelvin model the stress evolution equation is defined as:

$$\dot{s}_{ij} + \frac{1}{\tau} s_{ij} = (1 + \delta_{ij}) G_0 \dot{e}_{ij} + (1 + \delta_{ij}) \frac{G_\infty}{\tau} \dot{e}_{ij} .$$

The strain data as written to the d3plot database may be used to predict damage, see [Bandak 1991].

***MAT_PLASTIC_NONLINEAR_KINEMATIC**

This is Material Type 165. This relatively simple model, based on a material model by Lemaitre and Chaboche [1990], is suited to model nonlinear kinematic hardening plasticity. The model accounts for the nonlinear Bauschinger effect, cyclic hardening, and ratcheting. Huang [2009] programmed this model and provided it as a user subroutine. It is a very cost effective model and is available for shell and solid elements.

Card 1	1	2	3	4	5	6	7	8
Variable	MID	RO	E	PR	SIGY	H	C	GAMMA
Type	A	F	F	F	F	F	F	F
Default	none	none	none	none	none	0.0	0.0	0.0

Card 2	1	2	3	4	5	6	7	8
Variable	FS							
Type	F							
Default	10 ¹⁶							

VARIABLE**DESCRIPTION**

MID	Material identification. A unique number or label must be specified (see *PART).
RO	Mass density
E	Young's modulus
PR	Poisson's ratio
SIGY	Initial yield stress, σ_{y0}
H	Isotropic plastic hardening modulus
C	Kinematic hardening modulus

VARIABLE	DESCRIPTION
GAMMA	Kinematic hardening parameter, γ
FS	Failure strain for eroding elements

Remarks:

If the isotropic hardening modulus, H , is nonzero, the size of the surface increases as a function of the equivalent plastic strain, ε^p :

$$\sigma_y = \sigma_{y0} + H\varepsilon^p .$$

The rate of evolution of the kinematic component is a function of the plastic strain rate:

$$\dot{\alpha} = [Cn - \gamma\alpha]\dot{\varepsilon}^p ,$$

where n is the flow direction. The term, $\gamma\alpha\dot{\varepsilon}^p$, introduces the nonlinearity into the evolution law, which becomes linear if the parameter, γ , is set to zero.

***MAT_MOMENT_CURVATURE_BEAM**

This is Material Type 166. This material is for performing nonlinear elastic or multi-linear plastic analysis of Belytschko-Schwer beams with user-defined axial force-strain, moment curvature and torque-twist rate curves. If strain, curvature or twist rate is located outside the curves, use extrapolation to determine the corresponding rigidity. For multi-linear plastic analysis, the user-defined curves are used as yield surfaces.

Card 1	1	2	3	4	5	6	7	8
Variable	MID	R0	E	ELAF	EPFLG	CTA	CTB	CTT
Type	A	F	F	F	F	F	F	F
Default	none	none	none	none	0.0	0.0	0.0	0.0

Card 2	1	2	3	4	5	6	7	8
Variable	N1	N2	N3	N4	N5	N6	N7	N8
Type	F	F	F	F	F	F	F	F
Default	none	none	0.0 / none	0.0	0.0	0.0	0.0	0.0

Card 3	1	2	3	4	5	6	7	8
Variable	LCMS1	LCMS2	LCMS3	LCMS4	LCMS5	LCMS6	LCMS7	LCMS8
Type	I	I	I	I	I	I	I	I
Default	none	none	0 / none	0	0	0	0	0

MAT_166**MAT_MOMENT_CURVATURE_BEAM**

Card 4	1	2	3	4	5	6	7	8
Variable	LCMT1	LCMT2	LCMT3	LCMT4	LCMT5	LCMT6	LCMT7	LCMT8
Type	I	I	I	I	I	I	I	I
Default	none	none	0 / none	0	0	0	0	0

Card 5	1	2	3	4	5	6	7	8
Variable	LCT1	LCT2	LCT3	LCT4	LCT5	LCT6	LCT7	LCT8
Type	I	I	I	I	I	I	I	I
Default	none	none	0 / none	0	0	0	0	0

Multilinear Plastic Analysis Card. Additional card for EPFLG = 1.

Card 6	1	2	3	4	5	6	7	8
Variable	CFA	CFB	CFT	HRULE	REPS	RBETA	RCAPAY	RCAPAZ
Type	F	F	F	F	F	F	F	F
Default	1.0	1.0	1.0	0.0	10 ²⁰	10 ²⁰	10 ²⁰	10 ²⁰

VARIABLE**DESCRIPTION**

MID	Material identification. A unique number or label must be specified (see *PART).
RO	Mass density
E	Young's modulus. This variable controls the time step size and must be chosen carefully. Increasing the value of E will decrease the time step size.
ELAF	Load curve ID for the axial force-strain curve

VARIABLE	DESCRIPTION
EPFLG	Function flag: EQ.0.0: Nonlinear elastic analysis EQ.1.0: Multi-linear plastic analysis
CTA, CTB, CTT	Type of axial force-strain, moment-curvature, and torque-twist rate curves (see Remarks): EQ.0.0: Curve is symmetric. EQ.1.0: Curve is asymmetric.
N1 - N8	Axial forces at which moment-curvature curves are given. The axial forces must be ordered monotonically increasing. At least two axial forces must be defined if the curves are symmetric. At least three axial forces must be defined if the curves are asymmetric.
LCMS1 - LCMS8	Load curve IDs for the moment-curvature curves about axis <i>S</i> under corresponding axial forces.
LCMT1 - LCMT8	Load curve IDs for the moment-curvature curves about axis <i>T</i> under corresponding axial forces.
LCT1 - LCT8	Load curve IDs for the torque-twist rate curves under corresponding axial forces.
CFA, CFB, CFT	For multi-linear plastic analysis only. Ratio of axial, bending and torsional elastic rigidities to their initial values, no less than 1.0 in value.
HRULE	Hardening rule, for multi-linear plastic analysis only. EQ.0.0: Isotropic hardening GT.0.0.AND.LT.1.0: Mixed hardening EQ.1.0: Kinematic hardening
REPS	Rupture effective plastic axial strain
RBETA	Rupture effective plastic twist rate
RCAPAY	Rupture effective plastic curvature about axis <i>S</i>
RCAPAZ	Rupture effective plastic curvature about axis <i>T</i>

Remarks:

For symmetric curves (see fields CTA, CTB, and CTT above), all data points must be in the first quadrant, and at least three data points need to be given, starting from the origin, followed by the yield point.

For asymmetric curves, at least five data points are needed and exactly one point must be at the origin. The two points on both sides of the origin record the positive and negative yield points.

The last data point(s) has no physical meaning: it serves only as a control point for inter or extrapolation.

The curves are input by the user and treated in LS-DYNA as linearly piecewise functions. The curves must be monotonically increasing while the slopes must be monotonically decreasing.

***MAT_MCCORMICK**

This is Material Type 167. This material is intended for finite plastic deformations. McCormick's constitutive relation for materials exhibiting negative steady-state Strain Rate Sensitivity (SRS) defines this material's strength. See McCormick [1988] and Zhang, McCormick and Estrin [2001].

Card 1	1	2	3	4	5	6	7	8
Variable	MID	RO	E	PR	SIGY			
Type	A	F	F	F	F			

Card 2	1	2	3	4	5	6	7	8
Variable	Q1	C1	Q2	C2				
Type	F	F	F	F				

Card 3	1	2	3	4	5	6	7	8
Variable	S	H	OMEGA	TD	ALPHA	EPS0		
Type	F	F	F	F	F	F		

VARIABLE**DESCRIPTION**

MID	Material identification. A unique number or label must be specified (see *PART).
RO	Mass density
E	Young's modulus
PR	Poisson's ratio
SIGY	Initial yield stress
Q1	Isotropic hardening parameter, Q_1
C1	Isotropic hardening parameter, C_1

VARIABLE	DESCRIPTION
Q2	Isotropic hardening parameter, Q_2
C2	Isotropic hardening parameter, C_2
S	Dynamic strain aging parameter, S
H	Dynamic strain aging parameter, H
OMEGA	Dynamic strain aging parameter, Ω
TD	Dynamic strain aging parameter, t_d
ALPHA	Dynamic strain aging parameter, α
EPS0	Reference strain rate, $\dot{\epsilon}_0$

Remarks:

The uniaxial stress-strain curve is given in the following form:

$$\sigma(\epsilon^p, \dot{\epsilon}^p) = \sigma_Y(t_a) + R(\epsilon^p) + \sigma_v(\dot{\epsilon}^p) .$$

Viscous stress σ_v is given by

$$\sigma_v(\dot{\epsilon}^p) = S \times \ln \left(1 + \frac{\dot{\epsilon}^p}{\dot{\epsilon}_0} \right) ,$$

where S represents the instantaneous strain rate sensitivity and $\dot{\epsilon}_0$ is a reference strain rate.

In the McCormick model the yield strength includes a dynamic strain aging (DSA) contribution. The yield strength is defined as

$$\sigma_Y(t_a) = \sigma_o + S \times H \times \left[1 - \exp \left\{ - \left(\frac{t_a}{t_d} \right)^\alpha \right\} \right] ,$$

where σ_o is the yield strength for vanishing average waiting time t_a , and H , α , and t_d are material constants linked to dynamic strain aging.

The average waiting time is defined by the evolution equation

$$\dot{t}_a = 1 - \frac{t_a}{t_{a,ss}} ,$$

where the quasi-steady state waiting time $t_{a,ss}$ is given as

$$t_{a,ss} = \frac{\Omega}{\dot{\epsilon}^p} .$$

The strain hardening function R is defined by the extended Voce Law

$$R(\varepsilon^p) = Q_1[1 - \exp(-C_1\varepsilon^p)] + Q_2[1 - \exp(-C_2\varepsilon^p)] .$$

***MAT_POLYMER**

This is Material Type 168. This model is implemented for brick elements.

Card 1	1	2	3	4	5	6	7	8
Variable	MID	RO	E	PR	GAMMA0	DG	SC	ST
Type	A	F	F	F	F	F	F	F

Card 2	1	2	3	4	5	6	7	8
Variable	TEMP	K	CR	N	C			
Type	F	F	F	F	F			

VARIABLE**DESCRIPTION**

MID	Material identification. A unique number or label must be specified (see *PART).
RO	Mass density
E	Young's modulus, E
PR	Poisson's ratio, ν
GAMMA0	Pre-exponential factor, $\dot{\gamma}_{0A}$
DG	Energy barrier to flow, ΔG
SC	Shear resistance in compression, S_c
ST	Shear resistance in tension, S_t
TEMP	Absolute temperature, θ
K	Boltzmann constant, k
CR	Product, $C_r = nk\theta$
N	Number of "rigid links" between entanglements, N
C	Relaxation factor, C

Remarks:

The polymer is assumed to have two basic resistances to deformation:

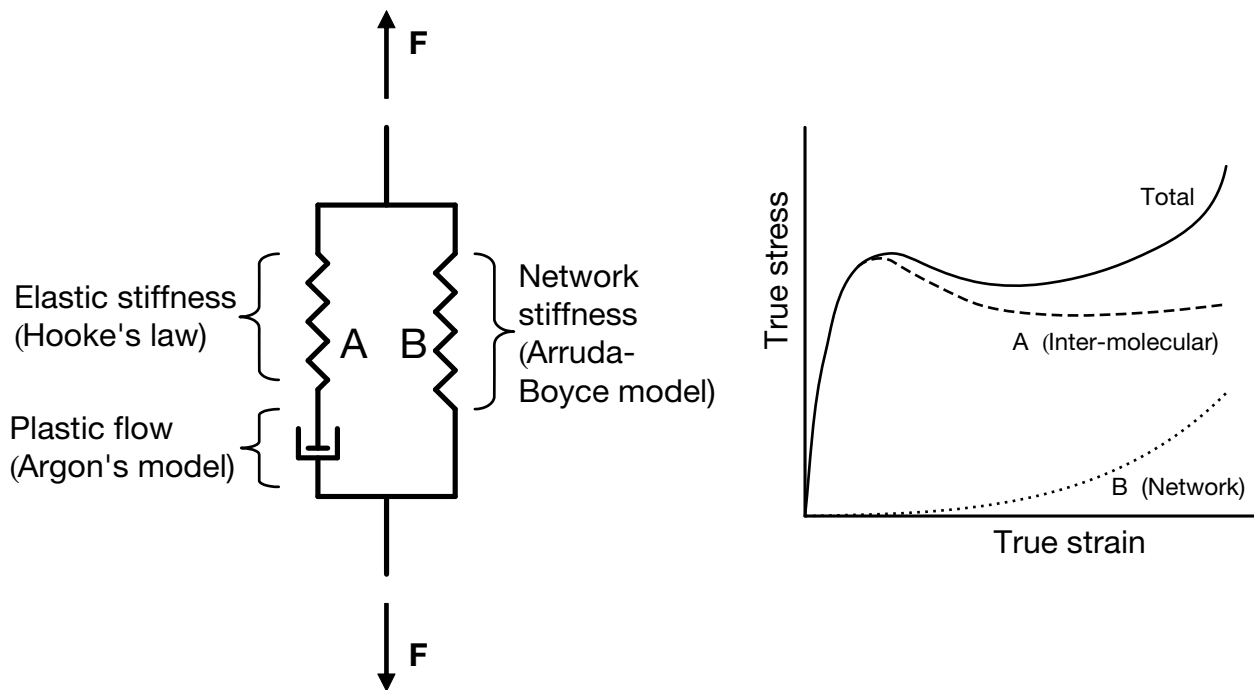

Figure M168-1. Stress decomposition in inter-molecular and network contributions.

1. An intermolecular barrier to deformation related to relative movement between molecules.
2. An evolving anisotropic resistance related to straightening of the molecule chains.

The model which is implemented and presented in this paper is mainly based on the framework suggested by Boyce et al. [2000]. Going back to the original work by Haward and Thackray [1968], they considered the uniaxial case only. The extension to a full 3D formulation was proposed by Boyce et al. [1988]. Moreover, Boyce and co-workers have during a period of 20 years changed or further developed the parts of the original model. Haward and Thackray [1968] used an Eyring model to represent the dashpot in Fig. M168-1, while Boyce et al. [2000] employed the double-kink model of Argon [1973] instead. Part B of the model, describing the resistance associated with straightening of the molecules, contained originally a one-dimensional Langevin spring [Haward and Thackray, 1968], which was generalized to 3D with the eight-chain model by Arruda and Boyce [1993].

The main structure of the model presented by Boyce et al. [2000] is kept for this model. Recognizing the large elastic deformations occurring for polymers, a formulation based

on a Neo-Hookean material is here selected for describing the spring in resistance A in Figure M168-1.

Referring to Figure M168-1, it is assumed that the deformation gradient tensor is the same for the two resistances (Part A and B)

$$\mathbf{F} = \mathbf{F}_A = \mathbf{F}_B$$

while the Cauchy stress tensor for the system is assumed to be the sum of the Cauchy stress tensors for the two parts

$$\boldsymbol{\sigma} = \boldsymbol{\sigma}_A + \boldsymbol{\sigma}_B .$$

Part A: Inter-Molecular Resistance:

The deformation is decomposed into elastic and plastic parts, $\mathbf{F}_A = \mathbf{F}_A^e \mathbf{F}_A^p$, where it is assumed that the intermediate configuration $\bar{\Omega}_A$ defined by \mathbf{F}_A^p is invariant to rigid body rotations of the current configuration. The velocity gradient in the current configuration Ω is defined by

$$\mathbf{L}_A = \dot{\mathbf{F}}_A \mathbf{F}_A^{-1} = \mathbf{L}_A^e + \mathbf{L}_A^p$$

Owing to the decomposition, $\mathbf{F}_A = \mathbf{F}_A^e \mathbf{F}_A^p$, the elastic and plastic rate-of-deformation and spin tensors are defined by

$$\begin{aligned} \mathbf{L}_A^e &= \mathbf{D}_A^e + \mathbf{W}_A^e = \dot{\mathbf{F}}_A^e (\mathbf{F}_A^e)^{-1} \\ \mathbf{L}_A^p &= \mathbf{D}_A^p + \mathbf{W}_A^p = \mathbf{F}_A^e \dot{\mathbf{F}}_A^p (\mathbf{F}_A^p)^{-1} (\mathbf{F}_A^e)^{-1} = \mathbf{F}_A^e \bar{\mathbf{L}}_A^p (\mathbf{F}_A^e)^{-1} \end{aligned}$$

where $\bar{\mathbf{L}}_A^p = \dot{\mathbf{F}}_A^p (\mathbf{F}_A^p)^{-1}$. The Neo-Hookean material represents an extension of Hooke's law to large elastic deformations and may be chosen for the elastic part of the deformation when the elastic behavior is assumed to be isotropic.

$$\boldsymbol{\tau}_A = \lambda_0 \ln J_A^e \mathbf{I} + \mu_0 (\mathbf{B}_A^e - \mathbf{I})$$

where $\boldsymbol{\tau}_A = J_A \boldsymbol{\sigma}_A$ is the Kirchhoff stress tensor of Part A and $J_A^e = \sqrt{\det \mathbf{B}_A^e} = J_A$ is the Jacobian determinant. The elastic left Cauchy-Green deformation tensor is given by $\mathbf{B}_A^e = \mathbf{F}_A^e \mathbf{F}_A^e{}^T$.

The flow rule is defined by

$$\mathbf{L}_A^p = \dot{\gamma}_A^p \mathbf{N}_A$$

where

$$\mathbf{N}_A = \frac{1}{\sqrt{2} \tau_A} \boldsymbol{\tau}_A^{\text{dev}}, \quad \tau_A = \sqrt{\frac{1}{2} \text{tr}(\boldsymbol{\tau}_A^{\text{dev}})^2}$$

and $\boldsymbol{\tau}_A^{\text{dev}}$ is the stress deviator. The rate of flow is taken to be a thermally activated process

$$\dot{\gamma}_A^p = \dot{\gamma}_{0A} \exp \left[-\frac{\Delta G(1 - \tau_A/s)}{k\theta} \right]$$

where $\dot{\gamma}_{0A}$ is a pre-exponential factor, ΔG is the energy barrier to flow, s is the shear resistance, k is the Boltzmann constant and θ is the absolute temperature. The shear resistance, s , is assumed to depend on the stress triaxiality, σ^* :

$$s = s(\sigma^*), \quad \sigma^* = \frac{\text{tr } \boldsymbol{\sigma}_A}{3\sqrt{3}\tau_A}.$$

The exact dependence is given by a user-defined load curve, which is linear between the shear resistances in compression and tension. These resistances are denoted s_c and s_t , respectively.

Part B: Network Resistance:

The network resistance is assumed to be nonlinear elastic with deformation gradient $\mathbf{F}_B = \mathbf{F}_B^N$, meaning, any viscoplastic deformation of the network is neglected. The stress-stretch relation is defined by

$$\boldsymbol{\tau}_B = \frac{nk\theta}{3} \frac{\sqrt{N}}{\bar{\lambda}_N} \mathcal{L}^{-1} \left(\frac{\bar{\lambda}_N}{\sqrt{N}} \right) (\bar{\mathbf{B}}_B^N - \bar{\lambda}_N^2 \mathbf{I})$$

where $\boldsymbol{\tau}_B = J_B \boldsymbol{\sigma}_B$ is the Kirchhoff stress for Part B, n is the chain density and N the number of "rigid links" between entanglements. In accordance with Boyce et. al [2000], the product, $nk\theta$, is denoted C_R herein. Moreover, \mathcal{L}^{-1} is the inverse Langevin function, $\mathcal{L}(\beta) = \coth \beta - 1/\beta$, and further

$$\bar{\mathbf{B}}_B^N = \bar{\mathbf{F}}_B^N \bar{\mathbf{F}}_B^{N^T}, \quad \bar{\mathbf{F}}_B^N = J_B^{-1/3} \mathbf{F}_B^N, \quad J_B = \det \mathbf{F}_B^N, \quad \bar{\lambda}_N = \left[\frac{1}{3} \text{tr } \bar{\mathbf{B}}_B^N \right]^{\frac{1}{2}}$$

The flow rule defining the rate of molecular relaxation reads

$$\mathbf{L}_B^F = \dot{\gamma}_B^F \mathbf{N}_B$$

where

$$\mathbf{N}_B = \frac{1}{\sqrt{2}} \frac{\boldsymbol{\tau}_B^{\text{dev}}}{\tau_B}, \quad \tau_B = \sqrt{\frac{1}{2} \boldsymbol{\tau}_B^{\text{dev}} : \boldsymbol{\tau}_B^{\text{dev}}}$$

The rate of relaxation is taken equal to

$$\dot{\gamma}_B^F = C \left(\frac{1}{\bar{\lambda}_F - 1} \right) \tau_B$$

where

$$\bar{\lambda}_F = \left[\frac{1}{3} \text{tr} \left(\mathbf{F}_B^F \{ \mathbf{F}_B^F \}^T \right) \right]^{\frac{1}{2}}$$

The model has been implemented into LS-DYNA using a semi-implicit stress-update scheme [Moran et. al 1990], and is available for the explicit solver only.

*MAT_ARUP_ADHESIVE

This is Material Type 169. This material model was created for adhesive bonding in aluminum structures. The plasticity model is not volume-conserving, so it avoids the spuriously high tensile stresses that can develop when modeling adhesive with traditional elasto-plastic material models. It is available *only* for solid elements of formulations 1, 2 and 15. Unless THKDIR = 1, the smallest dimension of the element is assumed to be the through-thickness dimension of the bond.

Card Summary:

Card 1. This card is required.

MID	RO	E	PR	TENMAX	GCTEN	SHRMAX	GCSHR
-----	----	---	----	--------	-------	--------	-------

Card 2. This card is required.

PWRT	PWRS	SHRP	SHT_SL	EDOT0	EDOT2	THKDIR	EXTRA
------	------	------	--------	-------	-------	--------	-------

Card 3. This card is included if EXTRA = 1 or 3.

TMAXE	GCTE	SMAXE	GCSE	PWRTE	PWRSE		
-------	------	-------	------	-------	-------	--	--

Card 4. This card is included if EXTRA = 1 or 3.

FACET	FACCT	FACES	FACCS	SOFTT	SOFTS		
-------	-------	-------	-------	-------	-------	--	--

Card 5. This card is included when EDOT2 ≠ 0.

SDFAC	SGFAC	SDEFAC	SGEFAC				
-------	-------	--------	--------	--	--	--	--

Card 6. This card is included if EXTRA = 2 or 3.

BTHK	OUTFAIL	FSIP	FBR713	ELF2NS			
------	---------	------	--------	--------	--	--	--

Data Card Definitions:

Card 1	1	2	3	4	5	6	7	8
Variable	MID	RO	E	PR	TENMAX	GCTEN	SHRMAX	GCSHR
Type	A	F	F	F	F	F	F	F
Default	none	none	none	none	10 ²⁰	10 ²⁰	10 ²⁰	10 ²⁰

VARIABLE**DESCRIPTION**

MID	Material identification. A unique number or label must be specified (see *PART).
RO	Mass density
E	Young's modulus
PR	Poisson's ratio
TENMAX	Maximum through-thickness tensile stress (see Remark 7): GT.0.0: Constant value LT.0.0: TENMAX is a function ID.
GCTEN	Energy per unit area to fail the bond in tension (see Remark 7): GT.0.0: Constant value LT.0.0: GCTEN is a function ID.
SHRMAX	Maximum through-thickness shear stress (see Remark 7): GT.0.0: Constant value LT.0.0: SHRMAX is a function ID.
GCSHR	Energy per unit area to fail the bond in shear (see Remark 7): GT.0.0: Constant value LT.0.0: GCSHR is a function ID.

Card 2	1	2	3	4	5	6	7	8
Variable	PWRT	PWRS	SHRP	SHT_SL	EDOT0	EDOT2	THKDIR	EXTRA
Type	F	F	F	F	F	F	F	F
Default	2.0	2.0	0.0	0.0	1.0	0.0	0.0	0.0

VARIABLE**DESCRIPTION**

PWRT	Power law term for tension
PWRS	Power law term for shear
SHRP	Shear plateau ratio (optional): GT.0.0: Constant value LT.0.0: SHRP is a function ID (see Remark 7).
SHT_SL	Slope (non-dimensional) of yield surface at zero tension (see Remark 3)
EDOT0	Strain rate at which the “static” properties apply
EDOT2	Strain rate at which the “dynamic” properties apply (Card 5)
THKDIR	Through-thickness direction flag (see Remark 1): EQ.0.0: Smallest element dimension (default) EQ.1.0: Direction from nodes 1-2-3-4 to nodes 5-6-7-8
EXTRA	Flag to input further data: EQ.1.0: Interfacial failure properties (Cards 3 and 4) EQ.2.0: Bond thickness and more (Card 6) EQ.3.0: Both of the above

Interfacial Failure Properties Card. Additional card for EXTRA = 1 or 3.

Card 3	1	2	3	4	5	6	7	8
Variable	TMAXE	GCTE	SMAXE	GCSE	PWRTE	PWRSE		
Type	F	F	F	F	F	F		
Default	10 ²⁰	10 ²⁰	10 ²⁰	10 ²⁰	2.0	2.0		

VARIABLE**DESCRIPTION**

TMAXE	Maximum tensile force per unit length on edges of joint
GCTE	Energy per unit length to fail the edge of the bond in tension
SMAXE	Maximum shear force per unit length on edges of joint
GCSE	Energy per unit length to fail the edge of the bond in shear
PWRTE	Power law term for tension
PWRSE	Power law term for shear

Interfacial Failure Properties Card. Additional card for EXTRA = 1 or 3.

Card 4	1	2	3	4	5	6	7	8
Variable	FACET	FACCT	FACES	FACCS	SOFTT	SOFTS		
Type	F	F	F	F	F	F		
Default	1.0	1.0	1.0	1.0	1.0	1.0		

VARIABLE**DESCRIPTION**

FACET	Stiffness scaling factor for edge elements – tension
FACCT	Stiffness scaling factor for interior elements – tension
FACES	Stiffness scaling factor for edge elements – shear
FACCS	Stiffness scaling factor for interior elements – shear

VARIABLE	DESCRIPTION
SOFTT	Tensile strength reduction factor applied when a neighbor fails
SOFTS	Shear strength reduction factor applied when a neighbor fails

Dynamic Strain Rate Card. Additional card for EDOT2 \neq 0.

Card 5	1	2	3	4	5	6	7	8
Variable	SDFAC	SGFAC	SDEFAC	SGEFAC				
Type	F	F	F	F				
Default	1.0	1.0	1.0	1.0				

VARIABLE	DESCRIPTION
SDFAC	Factor on TENMAX and SHRMAX at strain rate EDOT2: GT.0.0: Constant value LT.0.0: SDFAC is a function ID (see Remark 7).
SGFAC	Factor on GCTEN and GCSHR at strain rate EDOT2: GT.0.0: Constant value LT.0.0: SGFAC is a function ID (see Remark 7).
SDEFAC	Factor on TMAXE and SMAXE at strain rate EDOT2
SGEFAC	Factor on GCTE and GCSE at strain rate EDOT2

Bond Thickness Card. Additional card for EXTRA = 2 or 3.

Card 6	1	2	3	4	5	6	7	8
Variable	BTHK	OUTFAIL	FSIP	FBR713	ELF2NS			
Type	F	F	F	F	F			
Default	0.0	0.0	0.0	0.0	0.0			

VARIABLE	DESCRIPTION
BTHK	Bond thickness (overrides thickness from element dimensions; see Remark 1): LT.0.0: BTHK is bond thickness, but critical time step remains unaffected. Helps to avoid very small time steps, but it can affect stability.
OUTFAIL	Flag for additional output to <code>messag</code> file which includes information about damage initiation time, failure function terms and forces: EQ.0.0: Off EQ.1.0: On
FSIP	Effective in-plane strain at failure
FBR713	Fallback option to get results from previous version. See Remark 8 . EQ.0.0: Off EQ.1.0: LS-DYNA release R7.1.3
ELF2NS	Volumetric smearing option for ELFORM = 2. See Remark 9 . EQ.0.0: Usual ELFORM = 2 behavior with volumetric smearing EQ.1.0: Volumetric smearing is turned off.

Remarks:

- Through-Thickness Direction and Bond Thickness.** The through-thickness direction is identified from the smallest dimension of each element by default (THKDIR = 0.0). It is expected that this dimension will be smaller than in-plane dimensions (typically 1 - 2 mm compared with 5 - 10 mm). If this is not the case, one can set the through-thickness direction using element numbering (THKDIR = 1.0). Then the thickness direction is expected to point from lower face (nodes 1-2-3-4) to upper face (nodes 5-6-7-8). For wedge elements these faces are the two triangular faces (nodes 1-2-5) and (nodes 3-4-6).

The bond thickness is assumed to be the element size in the thickness direction. This may be overridden using BTHK. In this case the behavior becomes independent of the element thickness. The elastic stiffness is affected by BTHK, so it is necessary to set the characteristic element length to a smaller value

$$l_e^{\text{new}} = \sqrt{\text{BTHK} \times l_e^{\text{old}}} .$$

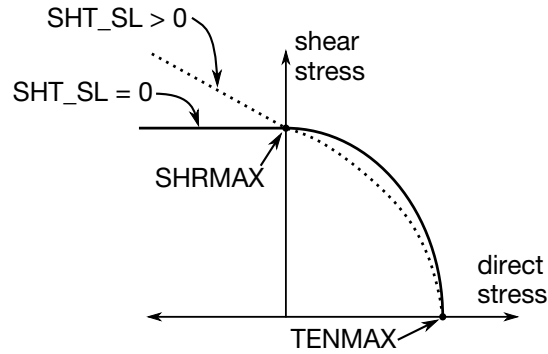

Figure M169-1. Figure illustrating the yield surface

This again affects the critical time step of the element, that is, a small BTHK can decrease the element time step significantly.

2. **Bond Stiffness and Strength.** In-plane stresses are set to zero: it is assumed that the stiffness and strength of the substrate is large compared with that of the adhesive, given the relative thicknesses.

If the substrate is modeled with shell elements, it is expected that these will lie at the mid-surface of the substrate geometry. Therefore, the solid elements representing the adhesive will be thicker than the actual bond. If the elastic compliance of the bond is significant, this can be corrected by increasing the elastic stiffness property E .

3. **Stress and Failure.** The yield and failure surfaces are treated as a power-law combination of direct tension and shear across the bond:

$$\left(\frac{\sigma}{\sigma_{\max}}\right)^{\text{PWRT}} + \left(\frac{\tau}{\tau_{\max} - \text{SHT_SL} \times \sigma}\right)^{\text{PWRS}} = 1.0$$

At yield SHT_SL is the slope of the yield surface at $\sigma = 0$. See [Figure M169-1](#).

The stress-displacement curves for tension and shear are shown in [Figure M169-2](#). In both cases, GC is the area under the curve. The displacement to failure in tension is given by

$$d_{\text{ft}} = 2 \left(\frac{\text{GCTEN}}{\text{TENMAX}} \right) ,$$

subject to a lower limit

$$d_{\text{ft}, \min} = \left(\frac{2L_0}{E'} \right) \text{TENMAX} ,$$

where L_0 is the initial element thickness (or BTHK if used) and

$$E' = \frac{E(1 - \nu)}{(1 - 2\nu)(1 + \nu)} .$$

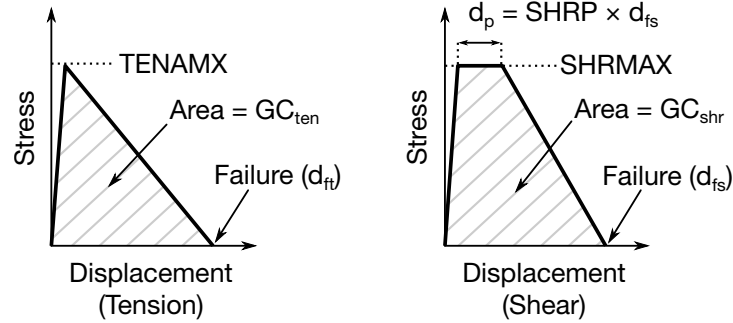

Figure M169-2. Stress-Displacement Curves for Tension and Shear

If GCTEN is input such that $d_{ft} < d_{ft, min}$, LS-DYNA will automatically increase GCTEN to make $d_{ft} = d_{ft, min}$. Therefore, GCTEN has a minimum value of

$$GCTEN \geq \frac{L_0}{E} (TENMAX)^2$$

Similarly, the minimum value for GCSHR is

$$GCSHR \geq \frac{L_0}{G} (SHRMAX)^2$$

where G is the elastic shear modulus.

Because of the algorithm used, yielding in tension across the bond does not require strains in the plane of the bond – unlike the plasticity models, plastic flow is not treated as volume-conserving.

4. **Output Variables.** The plastic strain output variable, PS, has a special meaning:
 - 0 < PS < 1: PS is the maximum value of the yield function experienced since time zero.
 - 1 < PS < 2: The element has yielded, and the strength is reducing towards failure – yields at PS = 1, fails at PS = 2.

Extra history variables may be requested for solid elements (NEIPH on *DATABASE_EXTENT_BINARY). They are described in the following table.

History Variable #	Description
1	Damage caused by cohesive deformation on a scale of 0 at first yield to 1 at failure
2	Damage caused by interfacial deformation (see Remark 6) on a scale of 0 at first yield to 1 at failure
5	Current thickness dimension of element

History Variable #	Description
6	Current strain rate (relevant if EDOT0 and EDOT2 are defined, see Remark 5)
10	Direct stress in local z-direction (bond tensile stress)
12	Through-thickness shear stress in local yz-direction
13	Through-thickness shear stress in local zx-direction

- Rate Effects.** When the plastic strain rate rises above EDOT0, rate effects are assumed to scale with the logarithm of the plastic strain rate, as in the example shown in [Figure M169-3](#) for cohesive tensile strength with dynamic factor SD-FAC. The same form of relationship is applied for the other dynamic factors. If EDOT0 is zero or blank, no rate effects are applied. Rate effects are applied using the viscoplastic method.
- Interfacial Failure.** Interfacial failure is assumed to arise from stress concentrations at the edges of the bond – typically the strength of the bond becomes almost independent of bond length. This type of failure is usually more brittle than cohesive failure. To simulate this, LS-DYNA identifies the free edges of the bond (made up of element faces that are not shared by other elements of material type *MAT_ARUP_ADHESIVE, excluding the faces that bond to the substrate). Only these elements can fail initially. The neighbors of failed elements can then develop free edges and fail in turn.

In real adhesive bonds, the stresses at the edges can be concentrated over very small areas; in typical finite element models the elements are much too large to capture this. Therefore, the concentration of loads onto the edges of the bond is accomplished artificially, by stiffening elements containing free edges (e.g. FACET, FACES > 1) and reducing the stiffness of interior elements (e.g. FACCT, FACCS < 1). Interior elements are allowed to yield at reduced loads (equivalent to TMAXE × FACET/FACCT and SMAXE × FACES/FACCS) to prevent excessive stresses developing before the edge elements have failed - but cannot be damaged until they become edge elements after the failure of their neighbors.

- Function Arguments.** Parameters TENMAX, GCTEN, SHRMAX, GCSHR, SHRP, SDFAC, and SGFAC can be defined as negative values. In that case, the absolute values refer to *DEFINE_FUNCTION IDs. The arguments of those functions include several properties of both connection partners if corresponding solid elements are in a tied contact with shell elements.

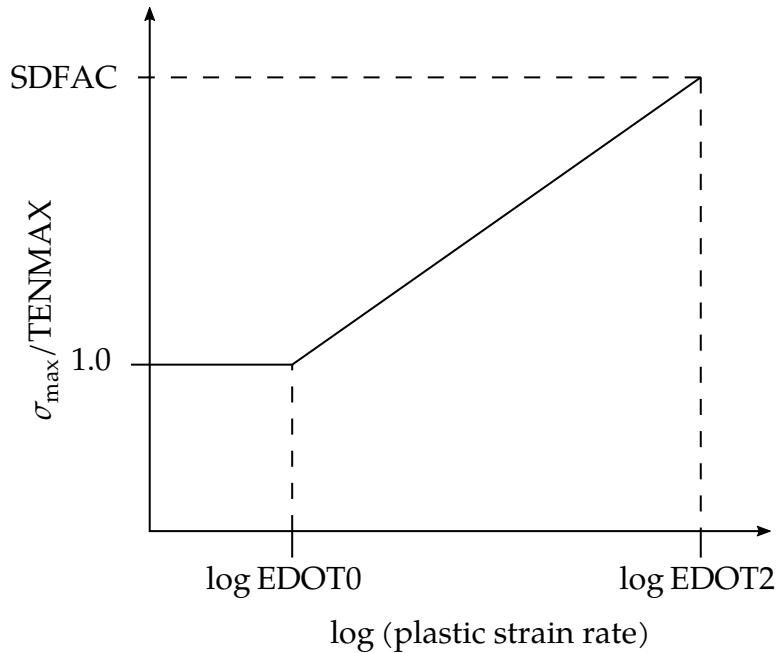

Figure M169-3. Figure illustrating rate effects

These functions depend on:

- (t1, t2) = thicknesses of both bond partners
- (sy1, sy2) = initial yield stresses at plastic strain of 0.002
- (sm1, sm2) = maximum engineering yield stresses (necking points)
- r = strain rate
- a = element area
- (e1, e2) = Young's moduli

For TENMAX = -100 such a function could look like:

```
*DEFINE_FUNCTION
    100
    func (t1, t2, sy1, sy2, sm1, sm2, r, a, e1, e2) = 0.5 * (sy1 + sy2)
```

Since material parameters must be identified from both bond partners during initialization, this feature is only available for a subset of material models at the moment, namely material models 24, 36, 120, 123, 124, 251, and 258.

8. **Older Versions.** Some corrections were made to this material model that can cause results to be different in R8 and later versions compared to R7.1.3 and earlier versions. To avoid recalibration of old material data, it is possible to recover previous results with option FBR713 = 1. The corrections were related to the post-yield stress-strain response not matching the description in the manual, with the difference being most noticeable when (a) the elastic stiffness was low, such that the elastic displacement to yield was of the same order as the element

thickness; or (b) when the power-law terms PWRS, PWRT were not both equal to 2, and strain rate effects were specified (EDOT2, SDFAC).

9. **Volumetric Smearing.** The element formulation given by ELFORM = 2 on *SECTION_SOLID smears the volumetric strain across the eight integration points. This smearing can sometimes cause an unstable dynamic response with *MAT_ARUP_ADHESIVE. The smearing can be turned off by setting ELF2NS to 1. ELFNS has no effect for other element formulations or when FBR713 is nonzero.

***MAT_RESULTANT_ANISOTROPIC**

This is Material Type 170. This model is available for the Belytschko-Tsay and the C0 triangular shell elements. It is based on a resultant stress formulation. In-plane behavior is treated separately from bending for modeling perforated materials, such as television shadow masks. The plastic behavior of each resultant is specified with a load curve and is completely uncoupled from the other resultants. If other shell formulations are specified, the formulation will be automatically switched to Belytschko-Tsay. As implemented, this material model cannot be used with user defined integration rules.

NOTE: This material does not support specification of a material angle, β_i , for each through-thickness integration point of a shell.

Card 1	1	2	3	4	5	6	7	8
Variable	MID	R0						
Type	A	F						

Card 2	1	2	3	4	5	6	7	8
Variable	E11P	E22P	V12P	V21P	G12P	G23P	G31P	
Type	F	F	F	F	F	F	F	

Card 3	1	2	3	4	5	6	7	8
Variable	E11B	E22B	V12B	V21B	G12B	AOPT		
Type	F	F	F	F	F	F		

Card 4	1	2	3	4	5	6	7	8
Variable	LN11	LN22	LN12	LQ1	LQ2	LM11	LM22	LM12
Type	F	F	F	F	F	F	F	F

Card 5	1	2	3	4	5	6	7	8
Variable				A1	A2	A3		
Type				F	F	F		

Card 6	1	2	3	4	5	6	7	8
Variable	V1	V2	V3	D1	D2	D3	BETA	
Type	F	F	F	F	F	F	F	

VARIABLE**DESCRIPTION**

MID	Material identification. A unique number or label must be specified.
RO	Mass density
E11P	E_{11p} , for in-plane behavior
E22P	E_{22p} , for in-plane behavior
V12P	ν_{12p} , for in-plane behavior
V11P	ν_{11p} , for in-plane behavior
G12P	G_{12p} , for in-plane behavior
G23P	G_{23p} , for in-plane behavior
G31P	G_{31p} , for in-plane behavior
E11B	E_{11b} , for bending behavior
E22B	E_{22b} , for bending behavior
V12B	ν_{12b} , for bending behavior
V21B	ν_{21b} , for bending behavior
G12B	G_{12b} , for bending behavior

VARIABLE	DESCRIPTION
AOPT	<p>Material axes option (see MAT_OPTIONTROPIC_ELASTIC for a more complete description):</p> <p>EQ.0.0: Locally orthotropic with material axes determined by element nodes 1, 2, and 4, as with *DEFINE_COORDINATE_NODES, and then rotated about the shell element normal by the angle BETA.</p> <p>EQ.2.0: Globally orthotropic with material axes determined by vectors defined below, as with *DEFINE_COORDINATE_VECTOR.</p> <p>EQ.3.0: Locally orthotropic material axes determined by rotating the material axes about the element normal by an angle, BETA, from a line in the plane of the element defined by the cross product of the vector \mathbf{v} with the element normal.</p> <p>LT.0.0: The absolute value of AOPT is a coordinate system ID number (CID on *DEFINE_COORDINATE_NODES, *DEFINE_COORDINATE_SYSTEM or *DEFINE_COORDINATE_VECTOR).</p>
LN11	Yield curve ID for N_{11} , the in-plane force resultant
LN22	Yield curve ID for N_{22} , the in-plane force resultant
LN12	Yield curve ID for N_{12} , the in-plane force resultant
LQ1	Yield curve ID for Q_1 , the transverse shear resultant
LQ2	Yield curve ID for Q_2 , the transverse shear resultant
LM11	Yield curve ID for M_{11} , the moment
LM22	Yield curve ID for M_{22} , the moment
LM12	Yield curve ID for M_{12} , the moment
A1, A2, A3	(a_1, a_2, a_3) , components of vector \mathbf{a} for AOPT = 2
V1, V2, V3	(v_1, v_2, v_3) , components of vector \mathbf{v} for AOPT = 3
D1, D2, D3	(d_1, d_2, d_3) , components of vector \mathbf{d} for AOPT = 2
BETA	Material angle in degrees for AOPT = 0 and 3. It may be overridden on the element card; see *ELEMENT_SHELL_BETA.

Remarks:

The in-plane elastic matrix for in-plane, plane stress behavior is given by:

$$\mathbf{C}_{\text{in plane}} = \begin{bmatrix} Q_{11p} & Q_{12p} & 0 & 0 & 0 \\ Q_{12p} & Q_{22p} & 0 & 0 & 0 \\ 0 & 0 & Q_{44p} & 0 & 0 \\ 0 & 0 & 0 & Q_{55p} & 0 \\ 0 & 0 & 0 & 0 & Q_{66p} \end{bmatrix}$$

The terms Q_{ijp} are defined as:

$$Q_{11p} = \frac{E_{11p}}{1 - \nu_{12p}\nu_{21p}}$$

$$Q_{22p} = \frac{E_{22p}}{1 - \nu_{12p}\nu_{21p}}$$

$$Q_{12p} = \frac{\nu_{12p}E_{11p}}{1 - \nu_{12p}\nu_{21p}}$$

$$Q_{44p} = G_{12p}$$

$$Q_{55p} = G_{23p}$$

$$Q_{66p} = G_{31p}$$

The elastic matrix for bending behavior is given by:

$$\mathbf{C}_{\text{bending}} = \begin{bmatrix} Q_{11b} & Q_{12b} & 0 \\ Q_{12b} & Q_{22b} & 0 \\ 0 & 0 & Q_{44b} \end{bmatrix}$$

The terms Q_{ijp} are similarly defined.

Because this is a resultant formulation, no stresses are output to d3plot, and forces and moments are reported to elout in place of stresses.

***MAT_STEEL_CONCENTRIC_BRACE**

This is Material Type 171. It represents the cyclic buckling and tensile yielding behavior of steel braces and is intended primarily for seismic analysis. Use only for beam elements with ELFORM = 2 (Belytschko-Schwer beam).

Card 1	1	2	3	4	5	6	7	8
Variable	MID	RO	YM	PR	SIGY	LAMDA	FBUCK	FBUCK2
Type	A	F	F	F	F	F	F	F
Default	none	none	none	none	none	optional	optional	0.0

Card 2	1	2	3	4	5	6	7	8
Variable	CCBRF	BCUR	EPTCRIT	DAMF1	DAMF2	DAMEP1	DAMEP2	
Type	F	F	F	F	F	F	F	
Default	optional	optional	0.01	optional	optional	optional	optional	

Card 3	1	2	3	4	5	6	7	8
Variable	TS1	TS2	TS3	TS4	CS1	CS2	CS3	CS4
Type	F	F	F	F	F	F	F	F
Default	0.0	0.0	0.0	0.0	TS1	TS2	TS3	TS4

VARIABLE**DESCRIPTION**

MID	Material identification. A unique number or label must be specified (see *PART).
RO	Mass density
YM	Young's modulus

VARIABLE	DESCRIPTION
PR	Poisson's ratio
SIGY	Yield stress
LAMDA	Slenderness ratio, λ (optional – see remarks)
FBUCK	Initial buckling load (optional – see remarks. If used, should be positive)
FBUCK2	Optional extra term in initial buckling load – see remarks
CCBRF	Reduction factor on initial buckling load for cyclic behavior
BCUR	Optional load curve giving compressive buckling load (y -axis) as a function of compressive strain (x -axis - both positive)
EPTCRIT	Tensile plastic strain to reduce buckling strength to cyclic value
DAMF1	FEMA threshold at which damage begins (see Remark 5). EQ.0: No damage or failure based on FEMA thresholds
DAMF2	FEMA threshold at which element is eroded, applicable only if DAMF1 > 0
DAMEP1	Cumulative plastic strain at which damage begins (see Remark 5). EQ.0: No damage or failure based on plastic strain
DAMEP2	Cumulative plastic strain at which element is eroded, applicable only if DAMEP1 > 0
TS1 - TS4	Tensile axial strain FEMA thresholds 1 to 4 (see Remark 3)
CS1 - CS4	Compressive axial strain FEMA thresholds 1 to 4 (see Remark 3)

Remarks:

1. **General.** The brace element is intended to represent the buckling, yielding and cyclic behavior of steel elements, such as tubes or I-sections, that carry only axial loads. A single beam element should be used to represent each structural element. Empirical relationships are used to determine the buckling and cyclic load-deflection behavior. Details of the axial response are given after the Remarks.

2. **Strain Definitions.** Output variables, and the damage and failure treatment, refer to the following strain definitions, all of which relate to the axial direction of the beam element:
- a) Total strain: Change of length divided by initial length, positive in tension.
 - b) Plastic strain: Current inelastic strain, defined as total strain minus elastic strain. It is positive for tensile strains, negative for compressive strains. The term “plastic strain” is used here irrespective of whether the inelastic behavior represents yielding or buckling.
 - c) High-tide plastic strain: Maximum plastic strain that has occurred during the analysis. Separate values are recorded for tensile and compressive plastic strains.
 - d) Cumulative plastic strain: The sum of the absolute values of the plastic strain increments. The cumulative plastic strain increases whenever yielding or buckling occurs. For cyclic loading in the plastic or buckling regimes, this strain measure increases with each cycle.
3. **FEMA Thresholds.** FEMA thresholds are used in performance-based earthquake engineering to classify the response into categories such as “Elastic”, “Immediate Occupancy”, “Life Safe”, etc., according to the level of deformation of each structural element. During the analysis, the maximum high-tide tensile and compressive plastic strains are recorded. These are checked against the user-defined limits TS1 to TS4 and CS1 to CS4. The output flag is then set to 0, 1, 2, 3, or 4 according to which limits have been passed. The value in the output files is the highest such flag from tensile or compressive strains.
4. **Output.** In addition to the six resultants written for all beam elements, this material model writes further extra history variables to the d3plot and d3thdt files, given in the table below. The data is written in the same position in these files as where integrated beams write the stresses and strains at integration points requested by BEAMIP on *DATABASE_EXTENT_BINARY. Therefore, some post-processors may interpret this data as if the elements were integrated beams with 4 integration points, and in that case the data may be accessed by selecting the appropriate integration point and data component:

Int. Point	Data component in post-processor	Description
1	XX(RR) axial stress	Total axial deformation/strain
3	ZX(TR) shear stress	Internal energy

Int. Point	Data component in post-processor	Description
4	XX(RR) axial stress	Current buckling/yield force in compression
4	XY(RS) shear stress	Tensile high-tide plastic strain
4	ZX(TR) shear stress	Compressive high-tide plastic strain
4	Equivalent plastic strain	Cumulative plastic strain
4	XX(RR) axial strain	FEMA flag

5. **Damage and failure.** Optionally, damage and failure (element erosion) can be modelled. DAMF1 and DAMF2 control damage and failure based on high tide plastic strains. DAMEP1 and DAMEP2 control damage and failure based on cumulative plastic strain (fatigue-type damage). A combination of both of the above is obtained if all four input parameters are defined.

DAMF1 and DAMF2 refer to the “FEMA” output flag (see [Remark 3](#) above). Only integer values 0, 1, 2, 3 or 4 are meaningful because those are the possible values of the FEMA output flag. DAMEP1 and DAMEP2 refer to values of cumulative plastic strain.

Damage is modelled with a scaling factor, D , that multiplies the stiffness and strength of the element. DAMF1 and DAMEP1 define thresholds at which damage begins. Until that point is reached, the damage algorithm has no effect and $D = 1$. DAMF2 and DAMEP2 define the threshold at which damage is complete. At that point, $D = 0$, meaning the element has no remaining stiffness or strength and is deleted. Between DAMF1 and DAMF2 and between DAMEP1 and DAMEP2, D ramps down linearly from $D = 1.0$, when damage begins, to $D = 0.0$, when damage is complete.

If both damage mechanisms are modelled (i.e., DAMF1, DAMF2, DAMEP1, DAMEP2 are all nonzero), the damage scaling factors for the two mechanisms are multiplied together. Thus, damage and failure can occur by either mechanism depending on which thresholds are reached first.

Axial response:

The cyclic behavior is shown in [Figure M171-1](#) (compression shown as negative force and displacement). The initial buckling load (point 2) is:

$$F_{b, \text{initial}} = \text{FBUCK} + \frac{\text{FBUCK2}}{L^2} ,$$

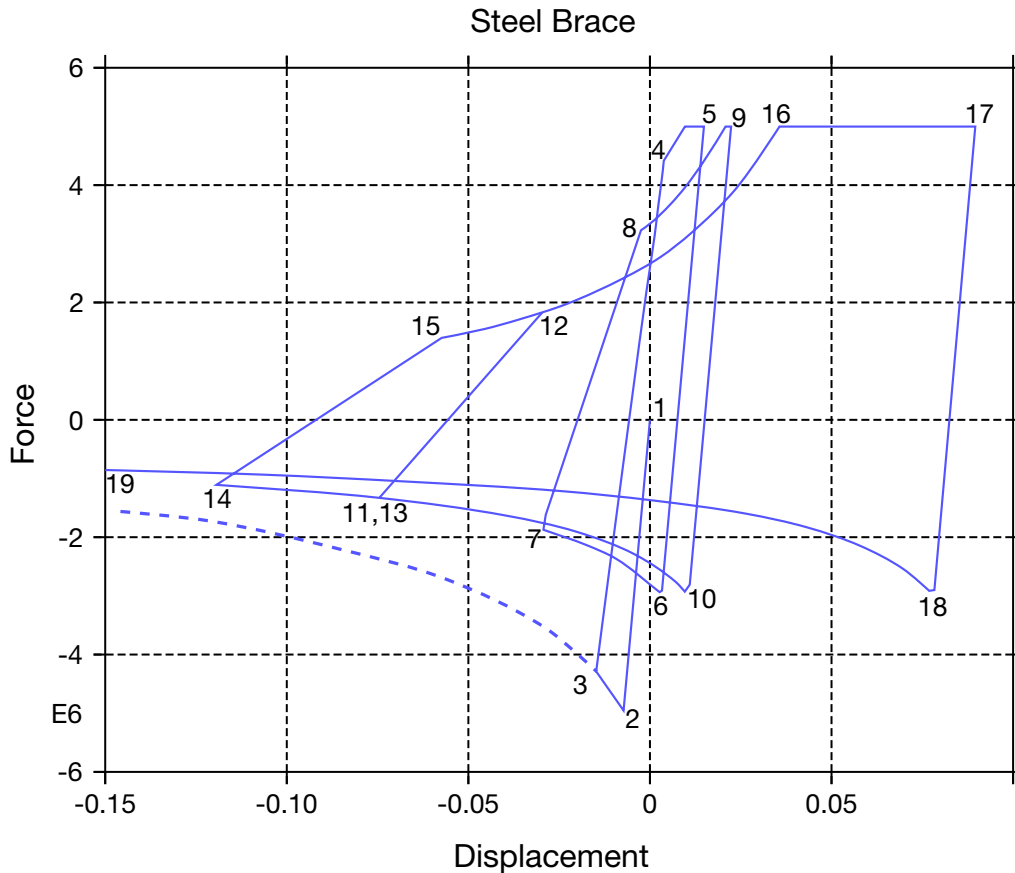

Figure M171-1. Cyclic Behavior of a Steel Brace

where FBUCK and FBUCK2 are input parameters, and L is the length of the beam element. If neither FBUCK nor FBUCK2 is defined, the default is that the initial buckling load is

$$\text{SIGY} \times A,$$

where A is the cross sectional area. The buckling curve (shown dashed) has the form:

$$F(d) = \frac{F_{b, \text{initial}}}{\sqrt{A\delta + B}}$$

where δ is $|\text{strain}/\text{yield strain}|$, and A and B are internally calculated functions of slenderness ratio (λ) and loading history.

The member slenderness ratio, λ , is defined as $\frac{kL}{r}$, where k depends on end conditions, L is the element length, and r is the radius of gyration such that $Ar^2 = I$ (and $I = \min(I_{yy}, I_{zz})$); λ will by default be calculated from the section properties and element length using $k = 1$. Optionally, this may be overridden by input parameter LAMDA to allow for different end conditions.

Optionally, you may provide a buckling curve BCUR. The points of the curve give compressive displacement (x -axis) as a function of force (y -axis); the first point should have

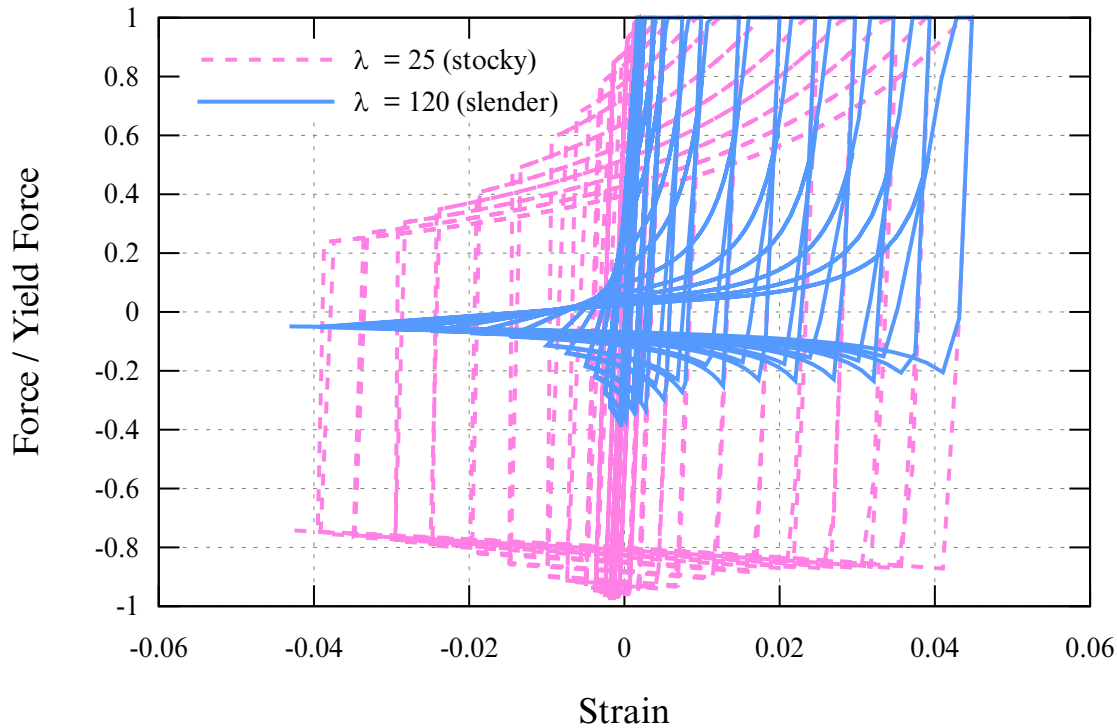

Figure M171-2. Comparing the stress-strain response for two values of λ

zero displacement and the initial buckling force. Displacement and force should both be positive. The initial buckling force must not be greater than the yield force.

The tensile yield force (point 5 and segment 16-17 in [Figure M171-1](#)) is defined by

$$F_y = \text{SIGY} \times A,$$

where yield stress SIGY is an input parameter and A is the cross-sectional area.

Following initial buckling and subsequent yield in tension, the member is assumed to be damaged. The initial buckling curve is then scaled by input parameter CCBRF, leading to reduced strength curves such as segments 6-7, 10-14 and 18-19. This reduction factor is typically in the range 0.6 to 1.0 (smaller values for more slender members). By default, CCBRF is calculated using SEAOC 1990:

$$\text{CCBRF} = \frac{1}{\left(1 + \frac{0.5\lambda}{\pi \sqrt{\frac{E}{0.5\sigma_y}}}\right)}$$

When tensile loading is applied after buckling, the member must first be straightened before the full tensile yield force can be developed. This is represented by a reduced unloading stiffness (such as segment 14-15) and the tensile reloading curve (segments 8-9 and 15-16). Further details can be found in Bruneau, Uang, and Whittaker [1998] and Structural Engineers Association of California [1974, 1990, 1996].

The response of stocky (low λ) and slender (high λ) braces are compared in [Figure M171-2](#). These differences are achieved by altering the input value LAMDA (or the section properties of the beam) and FBUCK.

***MAT_CONCRETE_EC2**

This is Material Type 172. This model is available for shell, thick shell (formulations 1, 2, and 6), and Hughes-Liu beam elements only. The material model can represent plain concrete only, reinforcing steel only, or a smeared combination of concrete and reinforcement. The model includes concrete cracking in tension and crushing in compression as well as reinforcement yield, hardening, and failure. Properties are thermally sensitive; the material model can be used for fire analysis. Material data and equations governing the behavior (including thermal properties) are taken from Eurocode 2 (EC2). See the remarks below for more details on how the standard is applied in the material model.

Although the material model offers many options, a reasonable response may be obtained by entering only RO, FC, and FT for plain concrete. If reinforcement is present, YMREINF, SUREINF, FRACRX, FRACRY must be defined, or for an alternative way to model the reinforcement, see *MAT_203/*MAT_HYSTERETIC_REINFORCEMENT. Note that, from release R10 onwards, the number of possible cracks has been increased from 2 (0 and 90 degrees) to 4 (see TYPEC on Card 1 and Tensile response under the [Material Behavior of Concrete](#) section).

NOTE: This material does not support specification of a material angle, β_i , for each through-thickness integration point of a shell (ICOMP = 1 on *SECTION_SHELL, B_i on *PART_COMPOSITE or B_i on *ELEMENT_SHELL_COMPOSITE).

Card Summary:

Card 1. This card is required.

MID	RO	FC	FT	TYPEC	UNITC	ECUTEN	FCC
-----	----	----	----	-------	-------	--------	-----

Card 2. This card is required.

ESOFT	LCHAR	MU	TAUMXF	TAUMXC	ECRAGG	AGGSZ	UNITL
-------	-------	----	--------	--------	--------	-------	-------

Card 3. This card is required.

YMREINF	PRREINF	SUREINF	TYPER	FRACRX	FRACY	LCRSU	LCALPS
---------	---------	---------	-------	--------	-------	-------	--------

Card 4. This card is required.

AOPT	ET36	PRT36	ECUT36	LCALPC	DEGRAD	ISHCHK	UNLFAC
------	------	-------	--------	--------	--------	--------	--------

Card 5. This card is included if AOPT > 0.0.

XP	YP	ZP	A1	A2	A3		
----	----	----	----	----	----	--	--

Card 6. This card is included if AOPT > 0.0.

V1	V2	V3	D1	D2	D3	BETA	
----	----	----	----	----	----	------	--

Card 7. This card is included if ISHCHK ≠ 0.

TYPECS	P_OR_F	EFFD	GAMSC	ERODET	ERODEC	ERODER	TMPOFF
--------	--------	------	-------	--------	--------	--------	--------

Card 8. This card is included if TYPEC = 6 or 9.

EC1_6	ECSP69	GAMCE9	PHIEF9				
-------	--------	--------	--------	--	--	--	--

Card 9. This card is included if FT < 0.0.

FT2	FTSHR	LCFTT	WRO_G	ZSURF			
-----	-------	-------	-------	-------	--	--	--

Data Card Definitions:

Card 1	1	2	3	4	5	6	7	8
Variable	MID	RO	FC	FT	TYPEC	UNITC	ECUTEN	FCC
Type	A	F	F	F	F	F	F	F
Default	none	none	none	0.0	1.0	1.0	0.0025	↓

VARIABLE

DESCRIPTION

MID	Material identification. A unique number or label must be specified (see *PART).
RO	Mass density
FC	Compressive strength of concrete (stress units). Its meaning depends on TYPEC. TYPEC.EQ.1,2,3,4,5,7,8: FC is the actual compressive strength. TYPEC.EQ.6: FC is the unconfined compressive strength used in Mander equations.

VARIABLE	DESCRIPTION
	<p>TYPEC.EQ.9: FC is the characteristic compressive strength (f_{ck} in EC2 1-1). See also FCC and the remarks below.</p>
FT	Tensile stress to cause cracking. If $FT < 0.0$, then Card 9 is read.
TYPEC	<p>Concrete aggregate type for stress-strain-temperature relationships (see Remark 3):</p> <p>EQ.1.0: Siliceous (default), Draft EC2 Annex (fire engineering)</p> <p>EQ.2.0: Calcareous, Draft EC2 Annex (fire engineering)</p> <p>EQ.3.0: Non-thermally-sensitive using ET3, ECU3</p> <p>EQ.4.0: Lightweight</p> <p>EQ.5.0: Fiber-reinforced</p> <p>EQ.6.0: Non-thermally-sensitive, Mander algorithm</p> <p>EQ.7.0: Siliceous, EC2 1-2:2004 (fire engineering)</p> <p>EQ.8.0: Calcareous, EC2 1-2:2004 (fire engineering)</p> <p>EQ.9.0: EC2 1-1:2004 (general and buildings)</p> <p>To obtain the pre-R10 behavior, that is, a maximum of 2 cracks, add 100 to TYPEC. For example, 109 means 2 cracks, EC2 1-1:2004 (general and buildings).</p>
UNITC	Factor to convert stress units to MPa (used in shear capacity checks and for application of EC2 formulae when TYPEC = 9). For example, if the model units are Newtons and meters, UNITC = 10^{-6} .
ECUTEN	Strain to fully open a crack
FCC	<p>Relevant only if TYPEC = 6 or 9.</p> <p>TYPEC.EQ.6: FCC is the compressive strength of confined concrete used in Mander equations. Default: unconfined properties are assumed ($FCC = FC$).</p> <p>TYPEC.EQ.9: FCC is the actual compressive strength. If blank, this will be set equal to the mean compressive strength (f_{cm} in EC2 1-1) as required for serviceability calculations (8MPa greater than FC). For ultimate load calculations the user may set FCC to a factored characteristic compressive strength. See remarks below.</p>

Card 2	1	2	3	4	5	6	7	8
Variable	ESOFT	LCHAR	MU	TAUMXF	TAUMXC	ECRAGG	AGGSZ	UNITL
Type	F	F	F	F	F	F	F	F
Default	0.0	0.0	0.4	10 ²⁰	1.161 × FT	0.001	0.0	1.0

VARIABLE**DESCRIPTION**

ESOFT	Tension stiffening (slope of stress-strain curve post-cracking in tension). See Figure M172-1 .
LCHAR	Characteristic length at which ESOFT applies, also used as crack spacing in aggregate-interlock calculation
MU	Friction on crack planes (max shear = $\mu \times$ compressive stress)
TAUMXF	Maximum friction shear stress on crack planes (ignored if AGGSZ > 0.0 - see remarks).
TAUMXC	Maximum through-thickness shear stress after cracking (see remarks).
ECRAGG	Strain parameter for aggregate interlock (ignored if AGGSZ > 0.0 - see remarks).
AGGSZ	Aggregate size (length units - used in NS3473 aggregate interlock formula - see remarks).
UNITL	Factor to convert length units to millimeters (used only if AGGSZ > 0.0 - see remarks). For example, if model unit is meters, UNITL = 1000.

Card 3	1	2	3	4	5	6	7	8
Variable	YMREINF	PRREINF	SUREINF	TYPER	FRACRX	FRACRY	LCRSU	LCALPS
Type	F	F	F	F	F	F	I	I
Default	none	0.0	0.0	2.0	0.0	0.0	0	0

VARIABLE**DESCRIPTION**

YMREINF	Young's modulus of reinforcement
PRREINF	Poisson's ratio of reinforcement
SUREINF	Ultimate stress of reinforcement
TYPER	Type of reinforcement for stress-strain-temperature relationships (see Remark 3): EQ.1.0: Hot rolled reinforcing steel, Draft EC2 Annex (fire) EQ.2.0: Cold worked reinforcing steel (default), Draft EC2 Annex (fire) EQ.3.0: Quenched/tempered prestressing steel, Draft EC2 Annex (fire) EQ.4.0: Cold worked prestressing steel, Draft EC2 Annex (fire) EQ.5.0: Non-thermally sensitive using load curve LCRSU EQ.7.0: Hot rolled reinforcing steel, EC2 1-2:2004 (fire) EQ.8.0: Cold worked reinforcing steel, EC2 1-2:2004 (fire)
FRACRX	Fraction of reinforcement (x -axis). For example, to obtain 1% reinforcement set FRACRX = 0.01. See Remark 1 .
FRACRY	Fraction of reinforcement (y -axis). For example, to obtain 1% reinforcement set FRACRY = 0.01. See Remark 1 .
LCRSU	Load curve for TYPER = 5 giving non-dimensional factor on SUREINF as a function of plastic strain (overrides stress-strain function from EC2).
LCALPS	Optional load curve giving thermal expansion coefficient of reinforcement as a function of temperature (overrides function from EC2).

Card 4	1	2	3	4	5	6	7	8
Variable	AOPT	ET36	PRT36	ECUT36	LCALPC	DEGRAD	ISHCHK	UNLFACT
Type	F	F	F	F	I	F	I	F
Default	0.0	0.0	0.25	↓	none	0.0	0	0.5

VARIABLE**DESCRIPTION**

AOPT

Material axes option (see *MAT_002 for a more complete description):

EQ.0.0: Locally orthotropic with material axes determined by element nodes 1, 2, and 4, as with *DEFINE_COORDINATE_NODES.

EQ.2.0: Globally orthotropic with material axes determined by vectors defined below, as with *DEFINE_COORDINATE_VECTOR.

EQ.3.0: Locally orthotropic material axes determined by rotating the material axes about the element normal by an angle, BETA, from a line in the plane of the element defined by the cross product of the vector \mathbf{v} with the element normal.

ET36

Young's modulus of concrete (TYPE = 3 and 6). For other values of TYPE, the Young's modulus is calculated internally (see remarks).

PRT36

Poisson's ratio of concrete. Applies to all values of TYPE.

ECUT36

Strain to failure of concrete in compression (TYPE = 3 and 6). See "Compressive response..." in section [Material Behavior of Concrete](#) below. Default is 0.02 for TYPE = 3 and $1.1 \times EC1_6$ for TYPE = 6.

LCALPC

Optional load curve giving thermal expansion coefficient of concrete as a function of temperature – overrides relationship from EC2.

DEGRAD

If non-zero, the compressive strength of concrete parallel to an open crack will be reduced (see remarks).

VARIABLE	DESCRIPTION
ISHCHK	Set this flag to 1 to include Card 7 (shear capacity check and other optional input data).
UNLFAC	Stiffness degradation factor after crushing (0.0 to 1.0 – see Figure M172-4).

Additional card for AOPT > 0.0.

Card 5	1	2	3	4	5	6	7	8
Variable	XP	YP	ZP	A1	A2	A3		
Type	F	F	F	F	F	F		
Default	0.0	0.0	0.0	0.0	0.0	0.0		

VARIABLE	DESCRIPTION
XP, YP, ZP	Not used
A1, A2, A3	Components of vector a for AOPT = 2.0

Additional card for AOPT > 0.

Card 6	1	2	3	4	5	6	7	8
Variable	V1	V2	V3	D1	D2	D3	BETA	
Type	F	F	F	F	F	F	F	
Default	0.0	0.0	0.0	0.0	0.0	0.0	0.0	

VARIABLE	DESCRIPTION
V1, V2, V3	Components of vector v for AOPT = 3.0
D1, D2, D3	Components of vector d for AOPT = 2.0
BETA	Material angle in degrees for AOPT = 3.0. BETA may be overridden on the element card; see *ELEMENT_SHELL_BETA

Include if ISHCHK \neq 0.

Card 7	1	2	3	4	5	6	7	8
Variable	TYPESC	P_OR_F	EFFD	GAMSC	ERODET	ERODEC	ERODER	TMPOFF
Type	F	F	F	F	F	F	F	F
Default	0.0	0.0	0.0	0.0	2.0	0.01	0.05	0.0

VARIABLE**DESCRIPTION**

TYPESC

Type of shear capacity check (see [Remark 5](#)):

EQ.1: BS 8110, no failure even if capacity is exceeded

EQ.2: ACI 318-05M, no failure even if capacity is exceeded

EQ.11: BS 8110, failure occurs if capacity is exceeded

EQ.12: ACI 318-05M, failure occurs if capacity is exceeded

P_OR_F

If BS8110 shear check, percent reinforcement – for example, if 0.5%, input 0.5. If ACI shear check, ratio (cylinder strength/FC) - defaults to 1.

EFFD

Effective section depth (length units), used in shear capacity check. This is usually the section depth excluding the cover concrete.

GAMSC

Load factor used in BS8110 shear capacity check

ERODET

Crack-opening strain at which element is deleted; see [Remark 7](#).

ERODEC

Compressive strain used in erosion criteria; see [Remark 7](#).

ERODER

Reinforcement plastic strain used in erosion criteria; see [Remark 7](#).

TMPOFF

Constant to be added to the model's temperature unit to convert into degrees Celsius. For example, if the model's temperature unit is degrees Kelvin, set TMPOFF to -273. Degrees Celsius temperatures are then used throughout the material model for LCALPC as well as for the default thermally-sensitive properties.

Additional card for TYPEC = 6 or 9.

Card 8	1	2	3	4	5	6	7	8
Variable	EC1_6	ECSP69	GAMCE9	PHIEF9				
Type	F	F	F	F				
Default	see remarks	see remarks	0.0	0.0				

VARIABLE**DESCRIPTION**

EC1_6	Strain at maximum compressive stress for Type 6 concrete
ECSP69	Spalling strain in compression for TYPEC = 6 and 9
GAMCE9	Material factor that divides the Youngs Modulus (TYPEC = 9)
PHIEF9	Effective creep ratio (TYPEC = 9)

Define this card only if FT < 0.0.

Card 9	1	2	3	4	5	6	7	8
Variable	FT2	FTSHR	LCFTT	WRO_G	ZSURF			
Type	F	F	F	F	F			
Default	FT	FT2	0.0	0.0	0.0			

VARIABLE**DESCRIPTION**

FT2	Tensile strength used for calculating tensile response
FTSHR	Tensile strength used for calculating post-crack shear response
LCFTT	Load curve defining factor on tensile strength as a function of time
WRO_G	Density times gravity for water pressure in cracks
ZSURF	Z-coordinate of water surface (for water pressure in cracks)

Remarks:

1. **Material Types.** This material model can be used to represent unreinforced concrete ($FRACR = 0.0$ where $FRACR = \max(FRACX, FRACY)$), reinforcing steel ($FRACR = 1.0$), or a smeared combination of reinforced concrete with evenly distributed reinforcement ($0.0 < FRACR < 1.0$). Concrete is modelled as an initially-isotropic material with a non-rotating smeared crack approach in tension, together with a plasticity model for compressive loading. Reinforcement is treated as separate sets of bars in the local material x and y axes. The reinforcement is assumed not to carry through-thickness shear or in-plane shear. Therefore, this material model should not be used to model steel-only sections, that is, do not create a section in which all the integration points are of *MAT_172 with both FRACRX and FRACRY set to 1.0.
2. **Creating Reinforced Concrete Sections.** Reinforced concrete sections for shell or beam elements may be created using *PART_COMPOSITE (for shells) or *INTEGRATION_BEAM (for beams) to define the section. Create one material definition to represent the concrete using *MAT_CONCRETE_EC2 with $FRACR = 0.0$. Create another material definition representing the reinforcement using *MAT_CONCRETE_EC2 with $FRACRX$ and/or $FRACRY = 1.0$. The material ID of each integration point is then set to represent either concrete or steel. The position of each integration point within the cross-section and its cross-sectional area are chosen to represent the actual distribution of reinforcement. If desired, *MAT_HYSTERETIC_REINFORCEMENT can be used for the reinforcement layers instead of *MAT_CONCRETE_EC2.
3. **Eurocode 2.** Eurocode 2 (EC2) contains different sections applicable to general structural engineering versus fire engineering. The latter contains different data for different types of concrete and steel and has been revised during its history. TYPEC and TYPER control the version and section of the EC2 document from which the material data is taken, and the types of concrete and steel being represented. In the descriptions of TYPEC and TYPER above, "Draft EC2 Annex (fire engineering)" means data taken from the 1995 draft Eurocode 2 Part 1-2 (for fire engineering), ENV 1992-1-2:1995. These are the defaults and are suitable for general use where elevated temperatures are not considered.

EC2 was then issued in 2004 (described above as EC2 1-2:2004 (fire)) with revised stress-strain data at elevated temperatures (TYPEC and TYPER = 7 or 8). These settings are recommended for analyses with elevated temperatures.

Meanwhile Eurocode 2 Part 1-1 (for general structural engineering), EC2 1-1:2004, contains material data and formulae that differ from Part 1-2; these are obtained by setting TYPEC = 9. This setting is recommended where compatibility is required with the structural engineering data and assumptions of Part 1-1 of the Eurocode.

A further option for modelling concrete, $TYPEC = 6$, is provided for applications, such as seismic engineering, in which the different stress-strain behaviors of confined versus unconfined concrete needs to be captured. This option uses equations by Mander et al and does not relate directly to Eurocode 2.

4. **Local Material Axes.** The local material axes define the directions of the reinforcement bars. If the reinforcement directions are not consistent across neighbouring elements, the response may be less stiff than intended – this is equivalent to the bars being bent at the element boundaries. Local material axes default to the same as the element axes, with the local x direction pointing from Node 1 to Node 2. The local material axes can be controlled using the angle $BETA$ on $*ELEMENT_SHELL_BETA$ or using $AOPT$ and associated input parameters in the material definition. See material type 2 for a description of the different $AOPT$ settings.

Only the reinforcement response depends on the local material axes, not the concrete response. Therefore, it is not usually necessary to set the local material axes for material definitions that do not have reinforcement (i.e., $FRACRX = 0$ and $FRACRY = 0$). However, when a reinforced concrete section is defined using $*PART_COMPOSITE$, and either the shear capacity check is invoked ($TYPESC > 0$, see [Remark 5](#)) or $CMPFLG$ is set on $*DATABASE_EXTENT_BINARY$, then it is important for all layers in the $*PART_COMPOSITE$ definition to have identical material axes. This can be achieved either by using the $BETA$ angle on $*ELEMENT_SHELL_BETA$ or by inputting identical $AOPT$ parameters for all the material definitions referenced by the $*PART_COMPOSITE$ card.

5. **Through-thickness Shear.** In this material model, cracks are initiated only by in-plane stresses caused by axial and bending effects. Once a crack has formed, the through-thickness shear stress is limited by considerations of aggregate interlock or friction on the crack surfaces. If the in-plane stresses are insufficient to cause cracks, the through-thickness shear strength is by default unlimited. Thus, failures caused primarily by through-thickness shear will not be predicted. The Shear Capacity Check option (see $TYPESC$) allows you to address this limitation. Two classes of behaviour are available (described in a and b), together with different options for the calculation of shear capacity (described in c and d):
 - a) $TYPESC < 10$ represents the situation where sufficient shear reinforcement will be provided to prevent any through-thickness failure. LS-DYNA generates extra history variables, so you can compare the shear demand to shear capacity to assess the requirements for shear reinforcement (see the list of extra history variables in [Remark 8](#)). Furthermore, we assume that the shear reinforcement will prevent any inelastic through-thickness shear deformation. Thus, through-thickness slipping on crack planes is automatically disabled.

- b) $TYPESC > 10$ represents the situation where no shear reinforcement is provided. A brittle failure occurs if the shear capacity is exceeded. Note, however, that the shear capacity is calculated from equations in design codes and may be quite conservative.
- c) If $TYPESC = 1$ or 11 , the shear capacity calculation is based on BS 8110-1:1997. You should supply the percentage reinforcement (P_OR_F), effective depth of section $EFFD$ (this typically excludes the cover concrete), and load factor $GAMSC$. These are used in Table 3.8 of BS 8110-1:1997 to determine the design shear stress. The “shear capacity” is this design shear stress times the total section thickness (force per unit width), modified according to Equation 6b of BS 8110 to allow for axial load.
- d) If $TYPESC = 2$ or 12 , the shear capacity calculation is based on ACI 318-05M. The shear capacity, ϕV_n , is calculated assuming $\phi = 0.75$ and taking V_n from ACI 318-05M equations 11-4 (for compressive axial load) or 11-8 (for tensile axial load). In these equations, f'_c is taken as $P_OR_F \times FC$, the term d is taken as $EFFD$, and the term b_w is taken as 1 to give shear capacity as a force per unit width. Note that in LS-DYNA versions prior to R13, Equation 11-4 was incorrectly implemented, so results from the $TYPESC = 2$ check prior to R13 should not be used.

For all of the above options, the “shear demand” (actual shear force per unit width) is compared to the shear capacity. This process is performed separately for each of the two local directions of the reinforcement in each element. When defining sections using $*PART_COMPOSITE$ or integration rules with multiple sets of material properties, it is important that each set of material properties referenced has the same local material axes (see [Remark 4](#)). The shear demand and axial load (used in calculation of the shear capacity) are summed across the integration points within the section. The extra history variables for capacity, demand, and difference between capacity and demand relate to the whole section (not to each integration point separately). Thus, the same values are written to all the integration points within an element.

- 6. **Thermal Expansion.** By default, thermal expansion properties from EC2 are used. If no temperatures are defined in the model, properties for 20°C are used. For $TYPEC = 3, 6$ or 9 , and $TYPER = 5$, there is no thermal expansion by default, and the properties do not vary with temperature. The user may override the default thermal expansion behaviour by defining curves of thermal expansion coefficient as a function of temperature ($LCALPC, LCALPR$). These apply no matter what types $TYPEC$ and $TYPER$ have been selected.
- 7. **Erosion Criteria.** Elements are deleted from the calculation when all of their integration points have reached the erosion criteria. Because this material model can represent plain concrete without reinforcement, pure reinforcement without

any concrete, or a smeared combination, the criteria depends on the type being modeled (see [Remark 1](#)). There are three criteria:

- a) *Concrete Tensile Strain Limit.* The concrete tensile (crack-opening) strain limit ERODET has been exceeded.
- b) *Concrete Compressive Strain Limit.* The concrete compressive strain limit ERODEC + ε_{csp} has been exceeded. ε_{csp} is the strain at which the stress-strain relation falls to zero.
- c) *Reinforcement Strain Limit.* The reinforcement strain limit ERODER + ε_{rsp} has been exceeded. ε_{rsp} is the strain at which the stress-strain relation falls to zero. However, if $\text{LCRSU} > 0$, ε_{rsp} is assumed to be 2.0.

The table below indicates which of the criteria apply to each of the variations of material type. Note that $\text{FRACR} = \max(\text{FRACX}, \text{FRACY})$ as discussed in [Remark 1](#).

FRACR	Material Type	Erosion Criteria	Erosion Criteria (in Plain English)
FRACR = 0.0	Pure concrete	(a).OR.(b)	The concrete tensile strain limit or concrete compressive strain limit conditions are satisfied.
$0.0 < \text{FRACR} < 1.0$	Smeared combination	((a).OR.(b)).AND.(c)	The reinforcement strain limit and either the concrete tensile strain limit or the concrete compressive strain limit are satisfied.
FRACR = 1.0	Pure steel reinforcement	(c)	The reinforcement strain limit is satisfied.

8. **Output.** “Plastic Strain” is the maximum of the plastic strains in the reinforcement in the two local directions.

Extra history variables may be requested for shell elements (NEIPS on *DATABASE_EXTENT_BINARY). They are described in the following table.

Extra Variable	Description
1	Current crack opening strain (if two cracks are present, max of two)
2	Equivalent uniaxial strain for concrete compressive behavior
3	Number of cracks (0, 1, 2, 3, or 4)

4	Temperature
5	Thermal strain
6	Current crack opening strain for the first crack to form
7	Current crack opening strain for the crack at 90 degrees to the first crack
8	Max crack opening strain for the first crack to form
9	Max crack opening strain for the crack at 90 degrees to the first crack
10	TYPESC.EQ.0: Maximum through-thickness shear stress (resultant of local YZ and ZX shear stresses) TYPESC.GE.1: Maximum difference (shear demand minus capacity) that has occurred so far in either of the two reinforcement directions
11	TYPESC.EQ.0: Maximum through-thickness YZ shear stress (element axes) TYPESC.GE.1: Maximum difference (shear demand minus capacity) that has occurred so far in reinforcement x-direction
12	TYPESC.EQ.0: Maximum through-thickness ZX shear stress (element axes) TYPESC.GE.1: Maximum difference (shear demand minus capacity) that has occurred so far in reinforcement y-direction
13	TYPESC.GE.1: Current shear demand minus capacity in reinforcement x-direction
14	TYPESC.GE.1: Current shear demand minus capacity in reinforcement y-direction
15	TYPESC.GE.1: Current shear capacity, V_{cx} , in reinforcement x-direction
16	TYPESC.GE.1: Current shear capacity, V_{cy} , in reinforcement y-direction
17	TYPESC.GE.1: Current shear demand, $V_{x'}$, in reinforcement x-direction

18	TYPESC.GE.1: Current shear demand, V_y , in reinforcement y -direction
19	TYPESC.GT.0: Maximum shear demand that has occurred so far in reinforcement x -direction
20	TYPESC.GT.0: Maximum shear demand that has occurred so far in reinforcement y -direction
21	Current strain in reinforcement (x -direction)
22	Current strain in reinforcement (y -direction)
23	Engineering shear strain (slip) across first crack
24	Engineering shear strain (slip) across second crack
25	x -stress in concrete (element local axes)
26	y -stress in concrete (element local axes)
27	xy -stress in concrete (element local axes)
28	yz -stress in concrete (element local axes)
29	xz -stress in concrete (element local axes)
30	Reinforcement stress (a -direction)
31	Reinforcement stress (b -direction)
32	TYPESC.GT.0: Current shear demand V_{\max}
33	TYPESC.GT.0: Maximum V_{\max} that has occurred so far
34	TYPESC.GT.0: Current shear capacity $V_{c\theta}$
35	TYPESC.GT.0: Excess shear, $V_{\max} - V_{c\theta}$
36	TYPESC.GT.0: Maximum excess shear that has occurred so far
56	Max crack opening strain for the crack at 45 degrees to first crack
57	Max crack opening strain for the crack at -45 degrees to first crack
58	Current crack opening strain for the crack at 45 degrees to first crack
59	Current crack opening strain for the crack at -45 degrees to first crack

In the above table V_{\max} is given by

$$V_{\max} = \sqrt{V_x^2 + V_y^2} ,$$

where V_x and V_y is the shear demand reinforcement in x and y directions respectively. Additionally,

$$V_{c\theta} = \frac{V_{\max}}{\sqrt{\left(\frac{V_x}{V_{cx}}\right)^2 + \left(\frac{V_y}{V_{cy}}\right)^2}} ,$$

where V_{cx} and V_{cy} are the shear capacities in the x - and y -directions, respectively.

Note that the concrete stress history variables are stored in element local axes irrespective of AOPT, that is, local x is always the direction from node 1 to node 2. The reinforcement stresses are in the reinforcement directions; these do take account of AOPT.

Material Behavior of Concrete:

Thermal sensitivity

For TYPEC = 1,2,4,5,7,8, the material properties are thermally-sensitive. If no temperatures are defined in the model, it behaves as if at 20°C. Pre-programmed relationships between temperature and concrete properties are taken from the EC2 document. The thermal expansion coefficient is as defined in EC2, is non-zero by default, and is a function of temperature. This coefficient may be overridden by inputting the curve LCALPC. TYPEC = 3, 6 and 9 are not thermally sensitive and have no thermal expansion coefficient by default.

Tensile response

The concrete is assumed to crack in tension when the maximum in-plane principal stress reaches FT. A non-rotating smeared crack approach is used. Cracks can open and close repeatedly under hysteretic loading. When a crack is closed, it can carry compression according to the normal compressive stress-strain relationships. The direction of the crack relative to the element coordinate system is stored when the crack first forms. The material can carry compression parallel to the crack even when the crack is open. Further cracks may then form at pre-determined angles to the first crack, if the tensile stress in that direction reaches FT. In versions up to R9, the number of further cracks is limited to one, at 90 degrees to the first crack. In versions starting from R10, up to three further cracks can form, at 45, 90 and 135 degrees to the first crack. The tensile stress is limited to FT only in the available crack directions. The tensile stress in other directions is unlimited and could exceed FT. This is a limitation of the non-rotating crack approach and

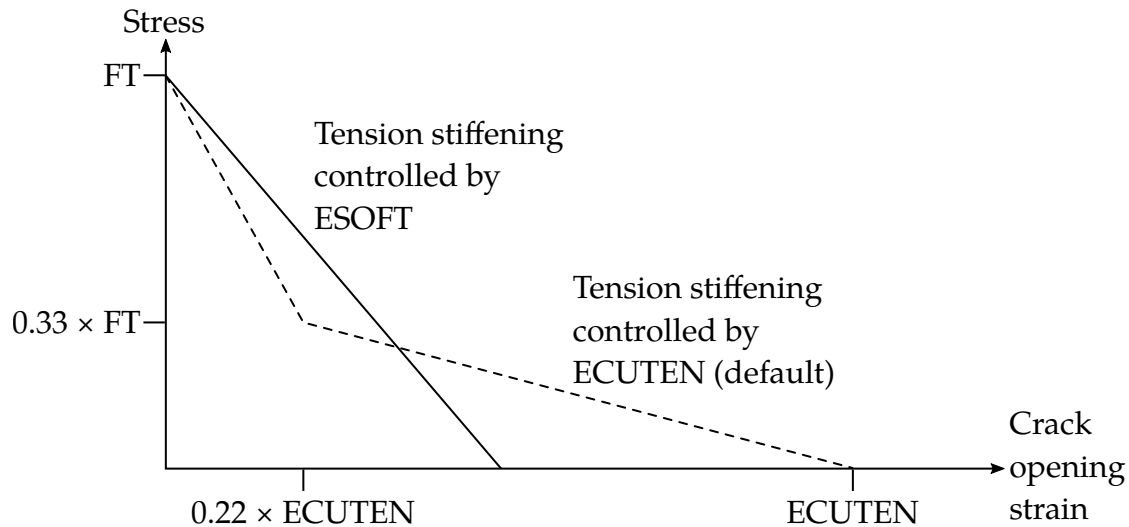

Figure M172-1. Tensile Behaviour of Concrete

may lead to models being non-conservative, that is, the response is stronger than implied by the input. The increase of the possible number of cracks from two to four significantly reduces this error and may therefore cause models to seem “weaker” in R10 than in R9 under some loading conditions. An option to revert to the previous 2-crack behavior is available in R10 – add 100 to TYPEC.

After initial cracking, the tensile stress reduces with increasing tensile strain. A finite amount of energy must be absorbed to create a fully open crack. In practice the reinforcement holds the concrete together, allowing it to continue to take some tension (this effect is known as tension-stiffening). The options available for the stress-strain curve are shown below. The piecewise curve is used by default. The simple linear curve applies only if $ESOFT > 0.0$ and $ECUTEN = 0.0$.

LCHAR can optionally be used to maintain constant energy per unit area of crack irrespective of mesh size, that is, the crack opening displacement is fixed rather than the crack opening strain. $LCHAR \times ECUTEN$ is then the displacement to fully open a crack. For the actual elements, crack opening displacement is estimated by $strain \times \sqrt{area}$. Note that if LCHAR is defined, it is also used as the crack spacing in the NS 3473 aggregate interlock calculation.

For the thermally-sensitive values of TYPEC, the relationship of FT with temperature is taken from EC2 – there is no input option to change this. FT is assumed to remain at its input value at temperatures up to 100°C, then to reduce linearly with temperature to zero at 600°C. Up to 500°C, the crack opening strain ECUTEN increases with temperature such that the fracture energy to open the crack remains constant. Above 500°C the crack opening strain does not increase further.

In some concrete design codes and standards, it is stipulated that the tensile strength of concrete should be assumed to be zero. However, for MAT_CONCRETE_EC2 it is not recommended to set FT to zero, because:

- Cracks will form at random orientations caused by small dynamic tensile stresses, leading to unexpected behavior when the loading increases because the crack orientations are fixed when the cracks first form;
- The shear strength of cracked concrete may then also become zero in the analysis (according to the aggregate interlock formula, the post-crack shear strength is assumed proportional to FT).

These problems may be tackled by using the inputs on Card 9. Firstly, separate tensile strengths may be input for the tensile response and for calculating the shear strength of cracked concrete. Secondly, by using the load curve LCFTT, the tensile strength may be ramped gradually down to zero after the static loads have been applied, ensuring that the cracks will form in the correct orientation.

Compressive response for TYPEC = 1, 2, 4, 5, 7, and 8

For TYPEC = 1, 2, 4, 5, 7, and 8, the compressive behavior of the concrete initially follows a stress-strain curve defined in EC2 as:

$$\text{Stress} = FC_{\max} \times \left[\left(\frac{\varepsilon}{\varepsilon_{c1}} \right) \times \frac{3}{2 + \left(\frac{\varepsilon}{\varepsilon_{c1}} \right)^3} \right],$$

where ε_{c1} is the strain at which the ultimate compressive strength, FC_{\max} , is reached, and ε is the current equivalent uniaxial compressive strain.

The initial elastic modulus is given by $E = 3 \times FC_{\max} / 2\varepsilon_{c1}$. Upon reaching FC_{\max} , the stress decreases linearly with increasing strain, reaching zero at a strain ε_{cu} . Strains ε_{c1} and ε_{cu} are by default taken from EC2 and are functions of temperature. At 20°C they take values 0.0025 and 0.02 respectively. FC_{\max} is also a function of temperature, given by the input parameter FC (which applies at 20°C) times a temperature-dependent softening factor taken from EC2. The differences among TYPEC = 1, 2, 4, 5, 7, and 8 are limited to (a) different reductions of FC at elevated temperatures and (b) different values of ε_{c1} at elevated temperatures.

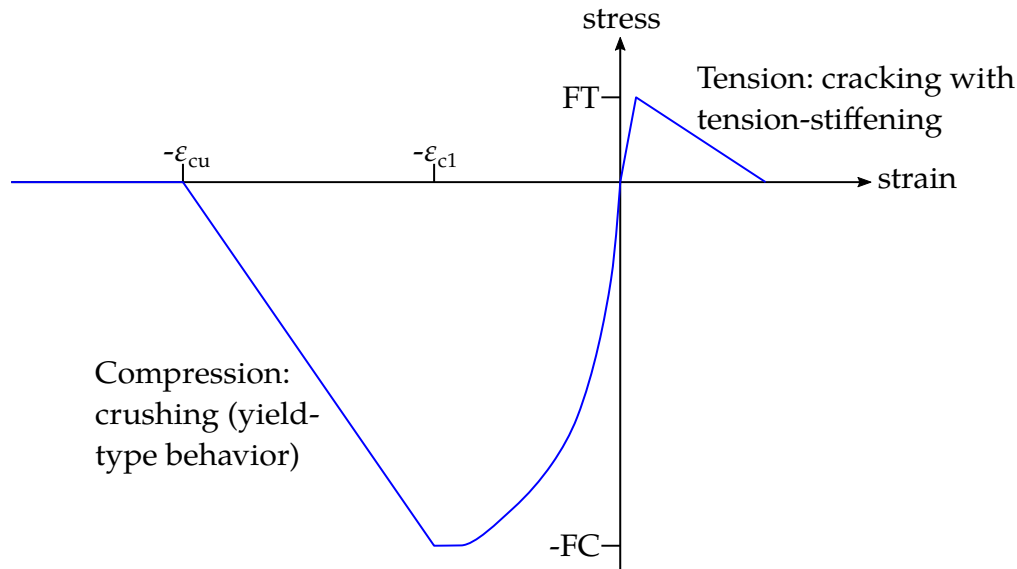

Figure M172-2. Concrete stress strain behavior

Compressive response for TYPEC = 3

For TYPEC = 3, the stress-strain behaviour follows the same form as described above. To over-ride the default values of the Young's modulus and ϵ_{cu} , set ET36 and ECUT36, respectively. In this case, the strain ϵ_{c1} is calculated from the elastic stiffness, and there is no thermal sensitivity.

Compressive response for TYPEC = 6

For TYPEC = 6, the above compressive crushing behaviour is replaced with the equations proposed by Mander. This algorithm can model unconfined or confined concrete; for unconfined, leave FCC blank. For confined concrete, input the confined compressive strength as FCC.

As indicated in [Figure M172-3](#), ϵ_{c1} is the strain at maximum compressive stress, ϵ_{cu} is the ultimate compressive strain, and ϵ_{csp} is the spalling strain. Default values for these quantities for both confined and unconfined concrete are calculated as follows:

$$\epsilon_{c1} = 0.002 \times \left[1 + 5 \left(\frac{FCC}{FC} - 1 \right) \right]$$

$$\epsilon_{cu} = 1.1 \times \epsilon_{c1}$$

$$\epsilon_{csp} = \epsilon_{cu} + 2 \frac{FCC}{E}$$

Note that for unconfined concrete, $FCC = FC$ causing ϵ_{c1} to default to 0.002. To over-ride the default values ϵ_{c1} , ϵ_{cu} , and ϵ_{csp} , set EC1_6, ECUT36, and ECSP69, respectively.

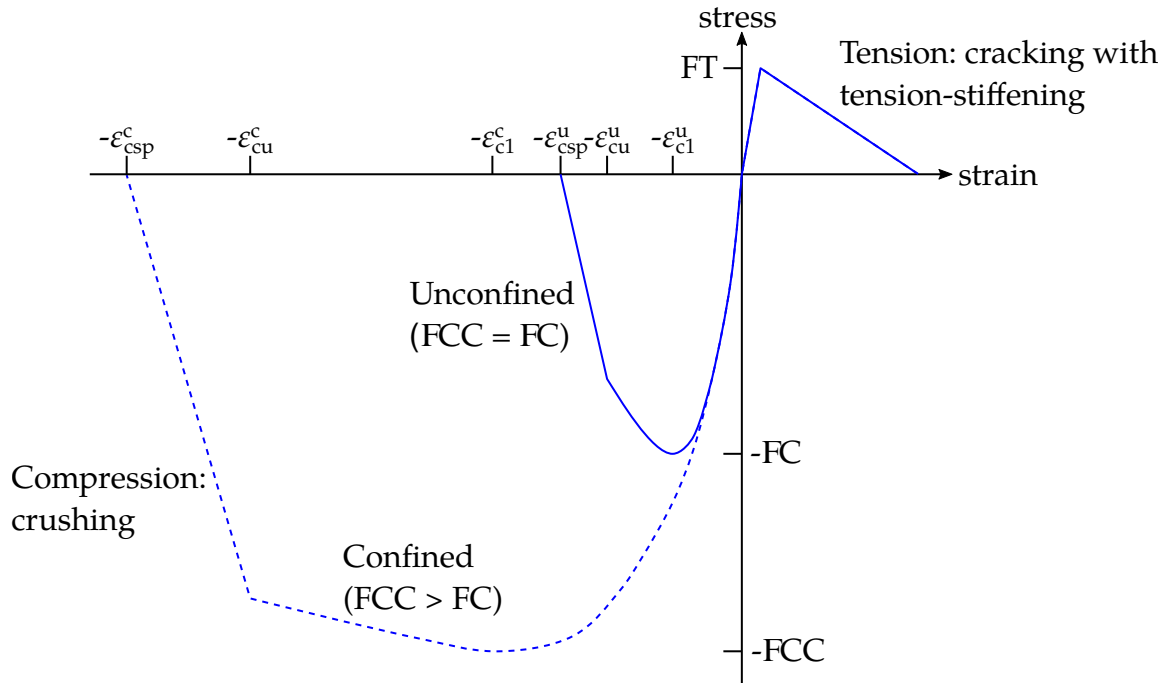

Figure M172-3. Type 6 concrete. Values with superscripts *u* and *c* specify they are for the unconfined and confined curves, respectively.

Compressive response: TYPEC = 9

For TYPEC = 9, the input parameter FC is the characteristic cylinder strength in the stress units of the model. $FC \times \text{UNITC}$ is assumed to be f_{ck} , the strength class in MPa units. The mean tensile strength f_{ctm} , mean Young’s modulus E_{cm} , and the strains used to construct the stress-strain curve such as ϵ_{c1} are by default evaluated automatically from tabulated functions of f_{ck} given in Table 3.1 of EC2. The compressive strength of the material is given by the input parameter FCC, which defaults to the mean compressive strength f_{cm} defined in EC2 as $f_{ck} + 8\text{MPa}$. The user may override the default compressive strength by inputting FCC explicitly. The stress-strain curve follows this form:

$$\frac{\text{Stress}}{\text{FCC}} = \frac{k\eta - \eta^2}{1 + (k - 2)\eta} ,$$

where FCC is the input parameter FCC (default: $= (f_{ck} + 8\text{MPa})/\text{UNITC}$), $\eta = \text{strain}/\epsilon_{c1}$, $k = 1.05E \times \epsilon_{c1}/\text{FCC}$, and E is the Young’s modulus.

The default parameters are intended to be appropriate for a serviceability analysis (mean properties), so default $FT = f_{ctm}$ and default $E = E_{cm}$. For an ultimate load analysis, FCC should be the “design compressive strength” (normally the factored characteristic strength, including any appropriate material factors); FT should be input as the factored characteristic tensile strength; GAMCE9 may be input (a material factor that divides the Young’s Modulus so $E = E_{cm}/\text{GAMCE9}$); and a creep factor PHIEF9 may be input that scales ϵ_{c1} by $(1 + \text{PHIEF9})$.

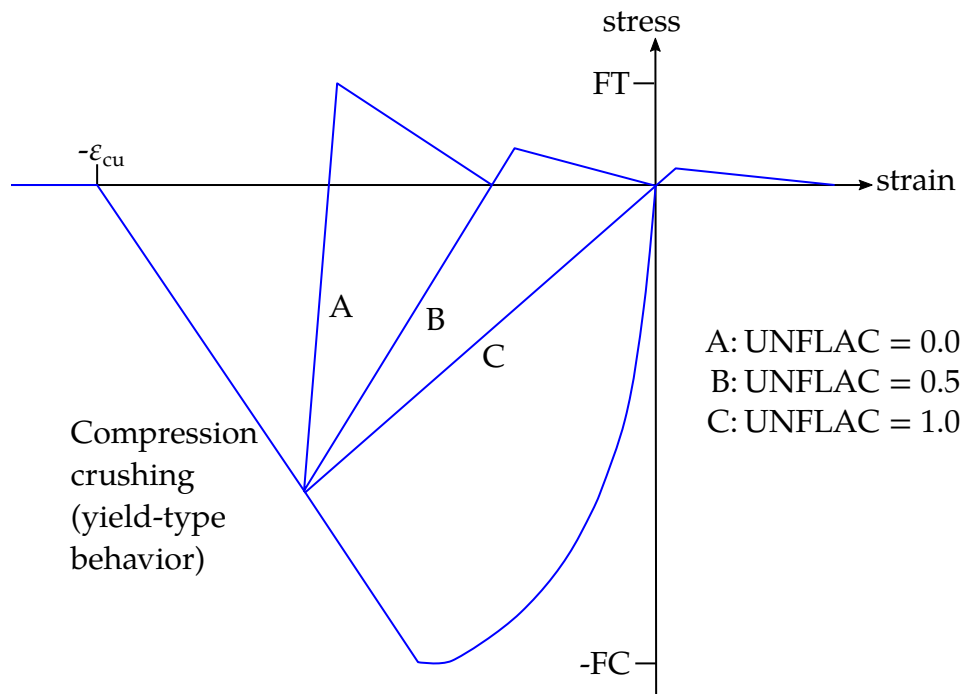
Unload/Reload Stiffness (All Concrete Types):**Figure M172-4.** Concrete unloading behavior

During compressive loading, the elastic modulus will be reduced according to the parameter UNLFAC (default = 0.5). See [Figure M172-4](#). UNLFAC = 0.0 means no reduction, that is, the initial elastic modulus will apply during unloading and reloading. UNLFAC = 1.0 means that unloading results in no permanent strain. Intermediate values imply a permanent strain linearly interpolated between these extremes. Tensile strength is reduced by the same factor as the elastic modulus.

Optional Compressive Strength Degradation due to Cracking:

By default, the compressive strength of cracked and uncracked elements is the same. If DEGRAD is non-zero, the formula from BS8110 is used to reduce compressive strength during or after crack opening has occurred:

$$\text{Reduction factor} = \min\left(1.0, \frac{1.0}{0.8 + 100\varepsilon_{tmax}}\right),$$

where ε_{tmax} is the maximum (tensile) crack-opening strain that has occurred up to the current time.

Shear Strength on Cracking Planes:

Before cracking, the through-thickness shear stress in the concrete is unlimited., unless TYPESC > 10 (see [Remark 5](#)) For cracked elements, shear stress on the crack plane

(magnitude of shear stress including element-plane and through-thickness terms) is treated in one of two ways:

1. If $AGGSZ > 0.0$, the relationship from Norwegian standard NS3473 is used to model the aggregate-interlock that allows cracked concrete to carry shear loading. The maximum shear stress that can be carried on the crack plane, τ_{max} , depends on compressive stress on the crack σ_c (if the crack is closed) or on crack opening width w (if the crack is open):

$$\tau_{max} = 0.18\tau_{rm} + 1.64\sigma_c - 0.82 \frac{\sigma_c^2}{\tau_{rm}}$$

$$\tau_{rm} = \frac{2FTSHR}{0.31 + \frac{24w}{(D_0 + 16)}}$$

FTSHR is defined on Card 9 and defaults to FT on Card 1.

UNITL is compulsory when AGGSZ is non-zero. This is the factor that converts model length units to millimeters, that is, the aggregate size in millimetres $D_0 = AGGSZ \times UNITL$.

The crack width is estimated from $w = UNITL \times \varepsilon_{cro} \times L_e$, where ε_{cro} is the crack opening strain and L_e is the crack spacing. L_e is taken as LCHAR if non-zero or is equal to element size if LCHAR is zero.

Optionally, TAUMXC may be used to set the maximum shear stress when the crack is closed and the normal stress is zero – by default this works out as $1.161 \times FT$ from the above equations. If TAUMXC is defined, the shear stress from the NS3473 formula, τ_{max} , is scaled by $TAUMXC / 1.161 \times FT$.

2. If $AGGSZ = 0.0$, the aggregate interlock is modeled by this formula:

$$\tau_{max} = \frac{TAUMXC}{1.0 + \frac{\varepsilon_{cro}}{ECRAGG}} + \min(MU \times \sigma_{comp}, TAUMXF) ,$$

where τ_{max} is the maximum shear stress carried across a crack; σ_{comp} is the compressive stress across the crack (this is zero if the crack is open); and ECRAGG is the crack opening strain at which the input shear strength TAUMXC is halved. Again, TAUMXC defaults to $1.161 \times FT$.

Note that if a shear capacity check is specified, the above applies only to in-plane shear, while the through-thickness shear is unlimited.

Reinforcement:

The reinforcement is treated as separate bars providing resistance only in the local x and y directions – it does not carry shear in-plane or out of plane.

For TYPER = 1, 2, 3, 4, 7, and 8, the behaviour is thermally sensitive and follows stress-strain relationships of a form defined in EC2. At 20°C (or if no thermal input is defined) the behaviour is elastic-perfectly-plastic with Young's Modulus EREINF and ultimate stress SUREINF, up to the onset of failure, after which the stress reduces linearly with increasing strain until final failure. At elevated temperatures there is a nonlinear transition between the elastic phase and the perfectly plastic phase, and EREINF and SUREINF are scaled down by temperature-dependent factors defined in EC2. The strain at which failure occurs depends on the reinforcement type (TYPER) and the temperature. For example, for hot-rolled reinforcing steel at 20°C failure begins at 15% strain and is complete at 20% strain. The thermal expansion coefficient is as defined in EC2 and is a function of temperature. This may be overridden by inputting the curve LCAPLS. The differences between TYPER = 1, 2, 4, 7, 8 are limited to (a) different reductions of EREINF and SUREINF at elevated temperatures, (b) different nonlinear transitions between elastic and plastic phases and (c) the strains at which softening begins and is complete.

The default stress-strain curve for reinforcement may be overridden using TYPER = 5 and LCRSU. In this case, the reinforcement properties are not temperature-sensitive and the yield stress is given by $SUREINF \times f(\epsilon_p)$, where $f(\epsilon_p)$ is the load curve value at the current plastic strain. To include failure of the reinforcement, the curve should reduce to zero at the desired failure strain and remain zero for higher strains. Note that by default LS-DYNA re-interpolates the input curve to have 100 equally-spaced points; if the last point on the curve is at very high strain, then the initial part of the curve may become poorly defined.

***MAT_MOHR_COULOMB**

This is Material Type 173. It is for solid elements only and is intended to represent cohesive or sandy soils and other granular materials. A simple soil model is obtained by defining Fields 1 through 4 of Card 1 together with PHI and/or CVAL while leaving all other fields blank. Joints (planes of weakness) may be added if required; the material then represents rock. The joint treatment is identical to that of *MAT_JOINTED_ROCK.

Card Summary:

Card 1. This card is required.

MID	RO	GMOD	RNU		PHI	CVAL	PSI
-----	----	------	-----	--	-----	------	-----

Card 2. This card is required.

NOVOID	NPLANES	EXTRA	LCCPDR	LCCPT	LCCJDR	LCCJT	LCSFAC
--------	---------	-------	--------	-------	--------	-------	--------

Card 3. This card is required.

GMODDP	GMODGR	LCGMEP	LCPHIEP	LCPSIEP	LCGMST	CVALGR	ANISO
--------	--------	--------	---------	---------	--------	--------	-------

Card 4. Include this card if EXTRA > 0.

LCGMT	LCCVT	LCPHI	EPDAM1	EPDAM2			
-------	-------	-------	--------	--------	--	--	--

Card 5. Include if NPLANES > 0. Repeat this card for each plane (maximum of 6 planes).

DIP	DIPANG	CPLANE	FRPLANE	TPLANE	SHRMAX	LOCAL	
-----	--------	--------	---------	--------	--------	-------	--

Data Card Definitions:

Card 1	1	2	3	4	5	6	7	8
Variable	MID	RO	GMOD	RNU	(blank)	PHI	CVAL	PSI
Type	A	F	F	F		F	F	F
Default	none	none	none	none		none	none	0.0

VARIABLE	DESCRIPTION
MID	Material identification. A unique number or label must be specified (see *PART).
RO	Mass density
GMOD	Elastic shear modulus
RNU	Poisson's ratio
PHI	Angle of friction (radians)
CVAL	Cohesion value (shear strength at zero normal stress)
PSI	Dilation angle (radians)

Card 2	1	2	3	4	5	6	7	8
Variable	NOVOID	NPLANES	EXTRA	LCCPDR	LCCPT	LCCJDR	LCCJT	LCSFAC
Type	1	I	I	I	I	I	I	I
Default	0	0	0	0	0	0	0	0

VARIABLE	DESCRIPTION
NOVOID	Voiding behavior flag (see Remarks 8 and 9): EQ.0: Voiding behavior on EQ.1: Voiding behavior off
NPLANES	Number of joint planes (maximum of 6)
EXTRA	Flag to input further data. If EXTRA > 0, then Card 4 is read.
LCCPDR	Load curve for extra cohesion for base material (dynamic relaxation)
LCCPT	Load curve for extra cohesion for base material (transient)
LCCJDR	Load curve for extra cohesion for joints (dynamic relaxation)
LCCJT	Load curve for extra cohesion for joints (transient)

VARIABLE**DESCRIPTION**

LCSFAC Load curve giving factor on strength as a function of time

Card 3	1	2	3	4	5	6	7	8
Variable	GMODDP	GMODGR	LCGMEP	LCPHIEP	LCPSIEP	LCGMST	CVALGR	ANISO
Type	F	F	I	I	I	I	F	F
Default	0.0	0.0	0	0	0	0	0.0	1.0

VARIABLE**DESCRIPTION**

GMODDP z-coordinate at which GMOD and CVAL are correct

GMODGR Gradient of GMOD as a function of z-coordinate (usually negative)

LCGMEP Load curve of GMOD as a function of plastic strain (overrides GMODGR)

LCPHIEP Load curve of PHI as a function of plastic strain

LCPSIEP Load curve of PSI as a function of plastic strain

LCGMST (Leave blank)

CVALGR Gradient of CVAL as a function of z-coordinate (usually negative)

ANISO Factor applied to elastic shear stiffness in global XZ and YZ planes

Card 4. Define Card 4 only if EXTRA > 0.

Card 4	1	2	3	4	5	6	7	8
Variable	LCGMT	LCCVT	LCPHT	EPDAM1	EPDAM2			
Type	F	F	F	F	F			
Default	0.0	0.0	0.0	10 ²⁰	0.0			

VARIABLE	DESCRIPTION
LCGMT	Load curve of nondimensional factor on GMOD as a function of time
LCCVT	Load curve of nondimensional factor on CVAL as a function of time
LCPHT	Load curve of nondimensional factor on PHI as a function of time
EPDAM1	Plastic strain or volumetric void strain at which damage begins
EPDAM2	Plastic strain or volumetric void strain at which element is eroded

Plane Cards. Define if NPLANES > 0. Repeat Card 5 for each plane (maximum 6 planes).

Card 5	1	2	3	4	5	6	7	8
Variable	DIP	DIPANG	CPLANE	FRPLANE	TPLANE	SHRMAX	LOCAL	
Type	F	F	F	F	F	F	I	
Default	0.0	0.0	0.0	0.0	0.0	10 ²⁰	0	

VARIABLE	DESCRIPTION
DIP	Angle of the plane in degrees below the horizontal (see Remark 11)
DIPANG	Plan view angle (degrees) of downhill vector drawn on the plane
CPLANE	Cohesion for shear behavior on plane
PHPLANE	Friction angle for shear behavior on plane (degrees)
TPLANE	Tensile strength across plane (generally zero or very small)
SHRMAX	Max shear stress on plane (upper limit, independent of compression)
LOCAL	Axes (see Remark 12): EQ.0: DIP and DIPANG are with respect to the global axes. EQ.1: DIP and DIPANG are with respect to the local element axes.

Remarks:

1. **Mohr Coulomb Yield Surface.** This material has a Mohr Coulomb yield surface, given by

$$\tau_{\max} = C + \sigma_n \tan(\text{PHI}) ,$$

where τ_{\max} is the maximum shear stress on any plane, σ_n is the normal stress on that plane (positive in compression), C is the cohesion, and PHI is the friction angle. The plastic potential function is of the form

$$\beta\sigma_k - \sigma_i + \text{constant},$$

where σ_k is the maximum principal stress, σ_i is the minimum principal stress, and

$$\beta = \frac{1 + \sin(\text{PSI})}{1 - \sin(\text{PSI})} .$$

2. **Depth-Dependent Properties.** If depth-dependent properties are used (see GMODDP, GMODGR, CVALGR), the model must be oriented with the z-axis in the upward direction.
3. **Plastic Strain.** Plastic strain is defined as

$$\sqrt{\frac{2}{3} \varepsilon_{pij} \varepsilon_{pij}} ,$$

that is, the same way as for other elasto-plastic material models.

4. **Plastic Strain Adjustments.** Friction and dilation angles PHI and PSI may vary with plastic strain (see LCPHIEP and LCPSIEP). To model heavily consolidated materials under large shear strains, as the strain increases, the dilation angle typically reduces to zero and the friction angle reduces to a lower, pre-consolidation value.

For similar reasons, the shear modulus may reduce with plastic strain (see LCGMEP), but this option may sometimes give unstable results.

5. **Additional Cohesion.** The load curves, LCCPDR, LCCPT, LCCJDR, and LCCJT, allow extra cohesion to be specified as a function of time. The cohesion is additional to that specified in the material parameters. This is intended for use during the initial stages of an analysis to allow application of gravity or other loads without cracking or yielding, and for the cracking or yielding then to be introduced in a controlled manner. This is done by specifying extra cohesion that exceeds the expected stresses initially, then declining to zero. If no curves are specified, no extra cohesion is applied.
6. **Time-Dependent Properties.** LCSFAC, the load curve for factor on strength, applies simultaneously to the cohesion and $\tan(\text{PHI})$ of the base material and

all joints. This feature is intended for reducing the strength of the material gradually to explore factors of safety. If no curve is present, a constant factor of 1 is assumed. Values much greater than 1.0 may cause problems with stability. Alternatively, separate functions of time may be defined for each of the properties GMOD, CVAL and PHI using load curves LCGMT, LCCVT and LCPHT, respectively.

7. **ANISO.** The anisotropic factor, ANISO, applies to the elastic shear stiffness in the global XZ and YZ planes. It can be used only in a pure Mohr-Coulomb mode (NPLANES = 0).
8. **Tensile Pressure Limit.** For a friction angle greater than zero, the Mohr Coulomb yield surface implies a tensile pressure limit equal to $CVAL/\tan(\text{PHI})$. By default, voids develop in the material when this pressure limit is reached, and the pressure will never become more tensile than the tensile pressure limit. The volumetric void strain is tracked and is reversible if the strain is reversed.
9. **NOVOID.** If NOVOID = 1, then the tensile pressure limit is not applied and stress states in which the pressure is more tensile than $CVAL/\tan(\text{PHI})$ are permitted but will be purely hydrostatic with no shear stress. NOVOID is recommended in Multi-Material ALE simulations in which the development of voids or air space is already accounted for by the Multi-Material ALE.
10. **Soil or Rock.** To model soil, set NJOINT = 0. The joints allow modeling of rock and are treated identically to those of *MAT_JOINTED_ROCK.
11. **Joint Plane Orientations.** The joint plane orientations are defined by the angle of a "downhill vector" drawn on the plane, meaning the vector is oriented within the plane to obtain the maximum possible downhill angle. DIP is the angle of this line below the horizontal. DIPANG is the plan-view angle of the line (pointing downhill) measured clockwise from the global Y-axis about the global Z-axis.
12. **Masonry and Joint Planes.** Joint planes are generally defined in the global axis system if they are taken from survey data, and the material represents rock. For this case, set LOCAL = 0. In other cases, it may be more convenient to define the joint plane angles, DIP and DIPANG, relative to the element local axis system (to do this, set LOCAL = 1). For example, this material model can be used to represent masonry with the weak planes representing the mortar joint. In this situation, these joints may be parallel to the local element axes throughout the mesh.

The choice of defining the joint angles relative to global versus local coordinates is available only for solid elements. For thick shell elements (*ELEMENT_TSHELL), DIP and DIPANG are always relative to the element local axis and the setting of LOCAL is ignored.

13. **Rigid Body Motion.** The joint planes rotate with the rigid body motion of the elements, irrespective of whether their initial definitions are in the global or local axis system.
14. **Extra History Variables.** Extra history variables may be requested (see NEIPH on *DATABASE_EXTENT_BINARY). They are described in the following table:

History Variable #	Description
1	Mobilized strength fraction for base material
2	Volumetric void strain
3	Maximum stress overshoot during plasticity calculation
4 – 9	Crack opening strain for planes 1 through 6
10 – 15	Crack accumulated engineering shear strain for planes 1 through 6
16 – 20	Current shear utilization for planes 1 through 6
21 – 27	Maximum shear utilization to date for planes 1 through 6
33	Elastic shear modulus (for checking depth-dependent input)
34	Cohesion (for checking depth-dependent input)

***MAT_RC_BEAM**

This is Material Type 174. It is for Hughes-Liu beam elements only. The material model can represent plain concrete only, reinforcing steel only, or a smeared combination of concrete and reinforcement. The main emphasis of this material model is the cyclic behavior. It is intended primarily for seismic analysis.

Card 1	1	2	3	4	5	6	7	8
Variable	MID	RO	EUNL	PR	FC	EC1	EC50	RESID
Type	A	F	F	F	F	F	F	F
Default	none	none	Rem 2	0.0	none	0.0022	Rem 2	0.2

Card 2	1	2	3	4	5	6	7	8
Variable	FT	UNITC	(blank)	(blank)	(blank)	ESOFT	LCHAR	OUTPUT
Type	F	F	F	F	F	F	F	F
Default	Rem 2	1.0	none	none	none	Rem 2	none	0

Card 3	1	2	3	4	5	6	7	8
Variable	FRACR	YMREIN	PRREIN	SYREIN	SUREIN	ESHR	EUR	RREINF
Type	F	F	F	F	F	F	F	F
Default	0.0	none	0.0	0.0	SYREIN	0.03	0.2	4.0

VARIABLE**DESCRIPTION**

MID Material identification. A unique number or label must be specified (see *PART).

RO Mass density

VARIABLE	DESCRIPTION
EUNL	Initial unloading elastic modulus (see Remark 2)
PR	Poisson's ratio.
FC	Cylinder strength (stress units)
EC1	Strain at which stress FC is reached.
EC50	Strain at which the stress has dropped to 50% FC
RESID	Residual strength factor
FT	Maximum tensile stress
UNITC	Factor to convert stress units to MPa (see Remark 2)
ESOFT	Slope of stress-strain curve post-cracking in tension
LCHAR	Characteristic length for strain-softening behavior
OUTPUT	Output flag controlling what is written as "plastic strain" (see Remark 4): EQ.0.0: Curvature EQ.1.0: "High-tide" plastic strain in reinforcement
FRACR	Fraction of reinforcement (for example, for 1% reinforcement FRACR = 0.01). See Remark 1 .
YMREIN	Young's Modulus of reinforcement
PRREIN	Poisson's Ratio of reinforcement
SYREIN	Yield stress of reinforcement
SUREIN	Ultimate stress of reinforcement
ESHR	Strain at which reinforcement begins to harden
EUR	Strain at which reinforcement reaches ultimate stress
R_REINF	Dimensionless Ramberg-Osgood parameter r . If zero, a default value of 4.0 will be used. If set to -1, parameters will be calculated from Kent & Park formulae (see Remark 3).

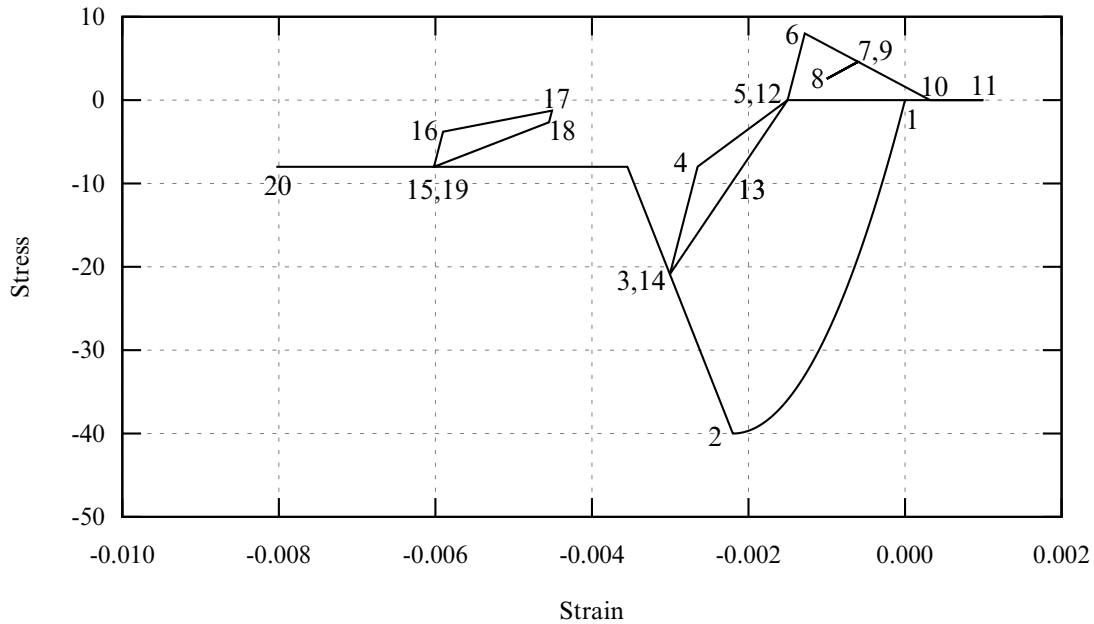

Figure M174-1. Example response for Concrete

Remarks:

1. **Creating sections for reinforced concrete beams.** This material model can be used to represent unreinforced concrete (FRACR = 0), steel (FRACR = 1), or reinforced concrete with evenly distributed reinforcement (0 < FRACR < 1).

Alternatively, you can specify the distribution in a section with *INTEGRATION_BEAM. In this case, the PID field for each integration point on *INTEGRATION_BEAM identifies the material for that integration point. You should create one part for concrete and another for steel. These parts should reference two materials of type *MAT_RC_BEAM, but one with FRACR = 0 and the other with FRACR = 1. Then, by assigning one or other of these part IDs to each integration point, the reinforcement can be applied to the correct locations within the section of the beam.

2. **Modeling Concrete.** In monotonic compression, we use the approach of Park and Kent, as described in Park & Paulay [1975]. The material follows a parabolic stress-strain curve up to a maximum stress equal to the cylinder strength FC . Thereafter, the strength decays linearly with strain until the residual strength is reached.

Default values for some material parameters will be calculated automatically as follows:

$$EC50 = \frac{(3 + 0.29FC)}{145FC - 1000}$$

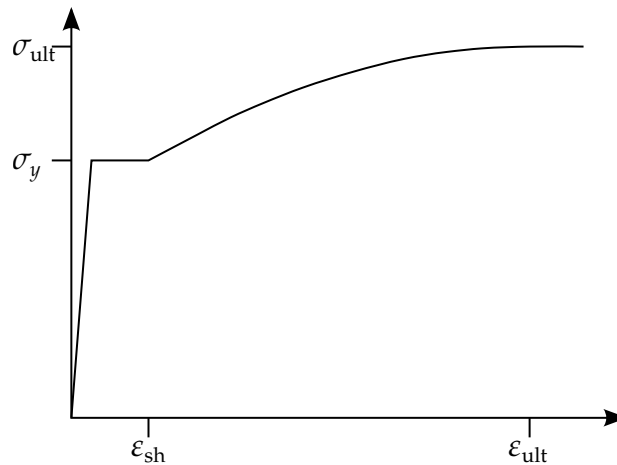

Figure M174-2. Monotonic tensile loading of the reinforcement

where FC is in MPa as per Park and Kent test data.

$$EUNL = \text{initial tangent slope} = \frac{2FC}{EC1}$$

Input values for EUNL lower than this are not permitted, but higher values may be defined if desired.

$$FT = 1.4 \left(\frac{FC}{10} \right)^{\frac{2}{3}}$$

where FC is in MPa as per Park and Kent test data.

$$ESOFT = EUNL$$

Input values higher than EUNL are not permitted. UNITC is used only to calculate default values for the above parameters from FC.

Strain-softening behavior tends to lead to deformations being concentrated in one element, and hence the overall force-deflection behavior of the structure can be mesh-size-dependent if the softening is characterized by strain. To avoid this, you may define a characteristic length (LCHAR). This is the length of specimen (or element) that would exhibit the defined monotonic stress-strain relationship. LS-DYNA adjusts the stress-strain relationship after ultimate load for each element, such that all elements irrespective of their length will show the same deflection during strain softening (that is, between ultimate load and residual load). Therefore, although deformation will still be concentrated in one element, the load-deflection behavior should be the same irrespective of element size. For tensile behavior, ESOFT is similarly scaled.

Cyclic behavior is broadly suggested by Blakeley and Park [1973] as described in Park & Paulay [1975]. The stress-strain response lies within the Park-Kent envelope and is characterized by stiff initial unloading response at slope EUNL

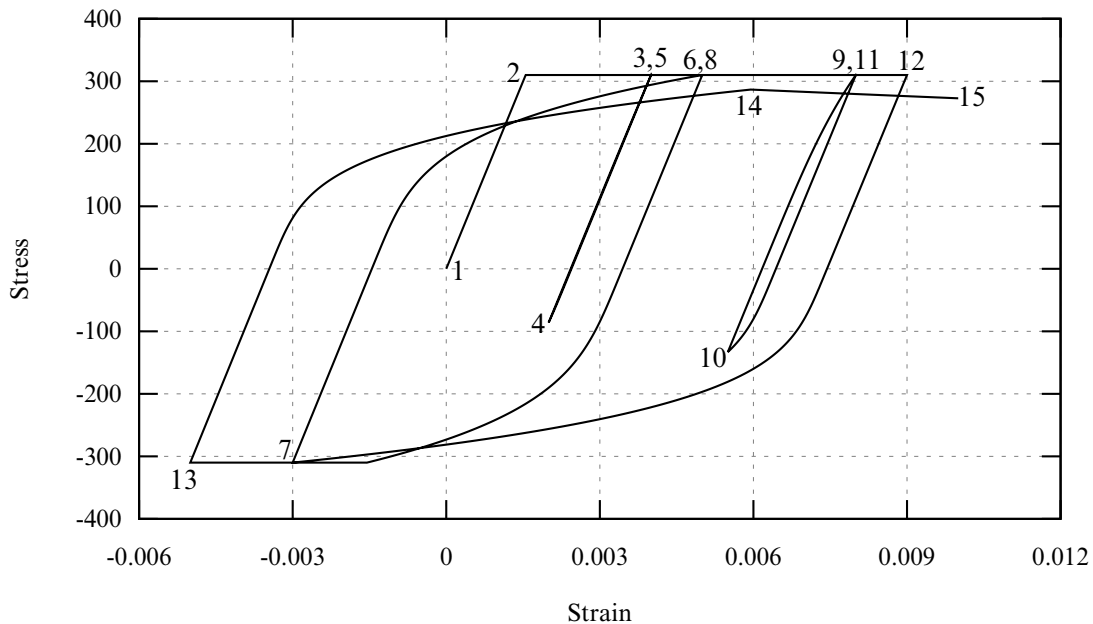

Figure M174-3. Stress vs. strain hysteresis plot for the reinforcement with RRE-INF = 4.0

followed by a less stiff response if it unloads to less than half the current strength. Reloading stiffness degrades with increasing strain.

In tension, the stress rises linearly with strain until a tensile limit F_T is reached. Thereafter the stiffness and strength decays with increasing strain at a rate E_{SOFT} . The stiffness also decays such that unloading always returns to strain at which the stress most recently changed to tensile.

3. **Modeling the Reinforcement.** Monotonic loading of the reinforcement results in the stress-strain curve shown in [Figure M174-2](#), which is parabolic between ϵ_{sh} and ϵ_{ult} . The same curve acts as an envelope on the hysteretic behavior when the x -axis is cumulative plastic strain.

Unloading from the yielded condition is elastic until the load reverses. Thereafter, the Bauschinger Effect (reduction in stiffness at stresses less than yield during cyclic deformation) is represented by following a Ramberg-Osgood relationship until the yield stress is reached:

$$\epsilon - \epsilon_s = \left(\frac{\sigma}{E}\right) \left\{ 1 + \left(\frac{\sigma}{\sigma_{CH}}\right)^{r-1} \right\}$$

where ϵ and σ are strain and stress, ϵ_s is the strain at zero stress, E is Young's Modulus, and r and σ_{CH} are as defined below

We have two options for calculating r and σ_{CH} , which is performed at each stress reversal:

- a) If RREINF is input as -1, r and σ_{CH} are calculated internally from formulae given in Kent and Park. Parameter r depends on the number of stress reversals. Parameter σ_{CH} depends on the plastic strain that occurred between the previous two stress reversals. The formulae were statistically derived from experiments but may not fit all circumstances. In particular, large differences in behavior may be caused by the presence or absence of small stress reversals such as could be caused by high frequency oscillations. Therefore, results might sometimes be unduly sensitive to small changes in the input data.
 - b) If RREINF is entered by the user or left blank, r is held constant while σ_{CH} is calculated on each reversal such that the Ramberg-Osgood curve meets the monotonic stress-strain curve at the point from which it last unloaded. For example, points 6 and 8 are coincident in [Figure M174-3](#). The default setting of 4.0 for RREINF gives similar hysteresis behavior to that described by Kent & Park but is unlikely to be so sensitive to small changes of input data.
4. **Output.** We recommend setting BEAMIP on *DATABASE_EXTENT_BINARY to request stress and strain output at the individual integration points. Note that for *MAT_RC_BEAM either element curvature or high tide plastic strain for the reinforcement is written to the output files in place of plastic strain depending on the setting of OUTPUT. In the post-processor, select "plastic strain" to display your selection of OUTPUT. For curvature, LS-DYNA compares the absolute values of the curvatures about the local y and z axes and outputs the larger value. In the post-processor, to display the total axial strain (elastic + plastic) at that integration point, select "axial strain." This can be combined with axial stress to create hysteresis plots, such as those shown in [Figures M174-1](#) and [M174-3](#).

***MAT_VISCOELASTIC_THERMAL**

This is Material Type 175. This material model provides a general viscoelastic Maxwell model having up to 12 terms in the prony series expansion and is useful for modeling dense continuum rubbers and solid explosives. Either the coefficients of the prony series expansion or a relaxation curve may be specified to define the viscoelastic deviatoric and bulk behavior. Note that *MAT_GENERAL_VISCOELASTIC (Material Type 76) has all the capability of *MAT_VISCOELASTIC_THERMAL and additionally offers more terms (18) in the prony series expansion and an optional scaling of material properties with moisture content.

Card Summary:

Card 1. This card is required.

MID	RO	BULK	PCF	EF	TREF	A	B
-----	----	------	-----	----	------	---	---

Card 2. If fitting is done from a relaxation curve, specify fitting parameters on Card 2; *otherwise* if constants are set on Card 3, *LEAVE THIS CARD BLANK*.

LCID	NT	BSTART	TRAMP	LCIDK	NTK	BSTARTK	TRAMPK
------	----	--------	-------	-------	-----	---------	--------

Card 3. These cards are not needed if data is defined using Card 2. This card can be input up to 6 times. The keyword ("*") card terminates this input.

G_i	BETA $_i$	K_i	BETA K_i				
-------	-----------	-------	------------	--	--	--	--

Data Card Definitions:

Card 1	1	2	3	4	5	6	7	8
Variable	MID	RO	BULK	PCF	EF	TREF	A	B
Type	A8	F	F	F	F	F	F	F

VARIABLE**DESCRIPTION**

MID	Material identification. A unique number or label not exceeding 8 characters must be specified.
RO	Mass density
BULK	Elastic bulk modulus

VARIABLE	DESCRIPTION
PCF	Tensile pressure elimination flag for solid elements only. If set to unity, tensile pressures are set to zero.
EF	Elastic flag: EQ.0: the layer is viscoelastic. EQ.1: the layer is elastic.
TREF	Reference temperature for shift function (must be greater than zero)
A	Coefficient for the Arrhenius and the Williams-Landel-Ferry shift functions
B	Coefficient for the Williams-Landel-Ferry shift function

Relaxation Curve Card. If fitting is done from a relaxation curve, specify fitting parameters on Card 2; *otherwise* if constants are set on Viscoelastic Constant Cards, *LEAVE THIS CARD BLANK.*

Card 2	1	2	3	4	5	6	7	8
Variable	LCID	NT	BSTART	TRAMP	LCIDK	NTK	BSTARTK	TRAMPK
Type	F	I	F	F	F	I	F	F

VARIABLE	DESCRIPTION
LCID	Load curve ID for deviatoric behavior if constants G_i and β_i are determined using a least squares fit. This relaxation curve is shown in Figure M175-1 .
NT	Number of terms in shear fit. If zero, 6 terms are used by default. Fewer than NT terms will be used if the fit produces one or more negative shear moduli. Currently, the maximum number is set to 6.
BSTART	In the fit, β_1 is set to zero, β_2 is set to BSTART, β_3 is 10 times β_2 , β_4 is 10 times β_3 , and so on. If zero, BSTART is determined by an iterative trial and error scheme.
TRAMP	Optional ramp time for loading

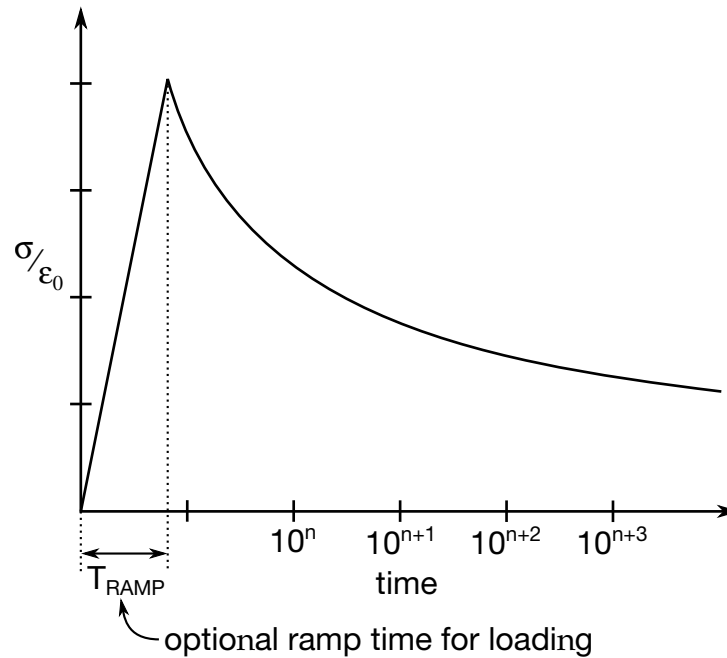

Figure M175-1. Relaxation curve. This curve defines stress as a function of time where time is defined on a logarithmic scale. For best results, the points defined in the load curve should be equally spaced on the logarithmic scale. Furthermore, the load curve should be smooth and defined in the positive quadrant. If nonphysical values are determined by least squares fit, LS-DYNA will terminate with an error message after the initialization phase is completed. If the ramp time for loading is included, then the relaxation which occurs during the loading phase is taken into account. This effect may or may not be important.

VARIABLE	DESCRIPTION
LCIDK	Load curve ID for bulk behavior if constants, K_i , and $\beta\kappa_i$ are determined using a least squares fit. This relaxation curve is shown in Figure M175-1 .
NTK	Number of terms desired in bulk fit. If zero 6 terms are used by default. Currently, the maximum number is set to 6.
BSTARTK	In the fit, $\beta\kappa_1$ is set to zero, $\beta\kappa_2$ is set to BSTARTK, $\beta\kappa_3$ is 10 times $\beta\kappa_2$, $\beta\kappa_4$ is 10 times $\beta\kappa_3$, and so on. If zero, BSTARTK is determined by an iterative trial and error scheme.
TRAMPK	Optional ramp time for bulk loading

Viscoelastic Constant Cards. Up to 6 cards may be input. The next keyword (“*”) card terminates this input. These cards are not needed if relaxation data is defined (Card 2). The number of terms for the shear behavior may differ from that for the bulk behavior: simply insert zero if a term is not included. If an elastic layer is defined, only G_i and K_i need to be defined (note in an elastic layer only one card is needed).

Card 3	1	2	3	4	5	6	7	8
Variable	G_i	BETA <i>i</i>	K_i	BETA <i>Ki</i>				
Type	F	F	F	F				

VARIABLE**DESCRIPTION**

G_i	Optional shear relaxation modulus for the i^{th} term
BETA <i>i</i>	Optional shear decay constant for the i^{th} term
K_i	Optional bulk relaxation modulus for the i^{th} term
BETA <i>Ki</i>	Optional bulk decay constant for the i^{th} term

Remarks:

Rate effects are taken into account through linear viscoelasticity by a convolution integral of the form:

$$\sigma_{ij} = \int_0^t g_{ijkl}(t - \tau) \frac{\partial \varepsilon_{kl}}{\partial \tau} d\tau ,$$

where $g_{ijkl}(t - \tau)$ is the relaxation functions for the different stress measures. This stress is added to the stress tensor determined from the strain energy functional.

If we wish to include only simple rate effects, the relaxation function is represented by six terms from the Prony series:

$$g(t) = \sum_{m=1}^N G_m e^{-\beta_m t} .$$

We characterize this in the input by shear moduli, G_i , and decay constants, β_i . An arbitrary number of terms, up to 6, may be used when applying the viscoelastic model.

For volumetric relaxation, the relaxation function is also represented by the Prony series in terms of bulk moduli:

$$k(t) = \sum_{m=1}^N K_m e^{-\beta_{k_m} t}$$

The Arrhenius and Williams-Landel-Ferry (WLF) shift functions account for the effects of the temperature on the stress relaxation. A scaled time, t' ,

$$t' = \int_0^t \Phi(T) dt ,$$

is used in the relaxation function instead of the physical time. The Arrhenius shift function is

$$\Phi(T) = \exp \left[-A \left(\frac{1}{T} - \frac{1}{T_{\text{REF}}} \right) \right] ,$$

and the Williams-Landel-Ferry shift function is

$$\Phi(T) = \exp \left(-A \frac{T - T_{\text{REF}}}{B + T - T_{\text{REF}}} \right) .$$

If all three values (T_{REF} , A , and B) are not zero, the WLF function is used; the Arrhenius function is used if B is zero; and no scaling is applied if all three values are zero.

***MAT_QUASILINEAR_VISCOELASTIC**

This is Material Type 176. This is a quasi-linear, isotropic, viscoelastic material based on a one-dimensional model by Fung [1993], which represents biological soft tissues, such as the brain. It is implemented for solid and shell elements. As of LS-DYNA version 971, a second formulation has been implemented that allows for larger strains, but in general, will not give the same results as the previous (default) implementation.

Card Summary:

Card 1. This card is required.

MID	RO	K	LC1	LC2	N	GSTART	M
-----	----	---	-----	-----	---	--------	---

Card 2. This card is required.

S0	E_MIN	E_MAX	GAMA1	GAMA2	K	EH	FORM
----	-------	-------	-------	-------	---	----	------

Card 3. This card is included if and only if LC1 = 0.

G1	BETA1	G2	BETA2	G3	BETA3	G4	BETA4
----	-------	----	-------	----	-------	----	-------

Card 4. This card is included if and only if LC1 = 0.

G5	BETA5	G6	BETA6	G7	BETA7	G8	BETA8
----	-------	----	-------	----	-------	----	-------

Card 5. This card is included if and only if LC1 = 0.

G9	BETA9	G10	BETA10	G11	BETA11	G12	BETA12
----	-------	-----	--------	-----	--------	-----	--------

Card 6. This card is included if and only if LC2 = 0.

C1	C2	C3	C4	C5	C6		
----	----	----	----	----	----	--	--

Data Card Definitions:

Card 1	1	2	3	4	5	6	7	8
Variable	MID	RO	K	LC1	LC2	N	GSTART	M
Type	A8	F	F	I	I	F	F	F
Default	none	none	none	0	0	6	1/TMAX	6

VARIABLE	DESCRIPTION
MID	Material identification. A unique number or label not exceeding 8 characters must be specified.
RO	Mass density
K	Bulk modulus
LC1	Load curve ID that defines the relaxation function in shear. This curve is used to fit the coefficients G_i and $BETA_i$. If zero, define the coefficients directly. The latter is recommended.
LC2	Load curve ID that defines the instantaneous elastic response in compression and tension. If zero, define the coefficients directly. <i>Symmetry is not assumed if only the tension side is defined; therefore, defining the response in tension only, may lead to nonphysical behavior in compression. Also, this curve should give a softening response for increasing strain without any negative or zero slopes. A stiffening curve or one with negative slopes is generally unstable.</i>
N	Number of terms used in the Prony series which must be less than or equal to 6. This number should be equal to the number of decades of time covered by the experimental data. Define this number if LC1 is nonzero. Carefully check the fit in the d3hsp file to ensure that it is valid, since the least square fit is not always reliable.
GSTART	Starting value for least square fit. If zero, a default value is set equal to the inverse of the largest time in the experiment. Define this number if LC1 is nonzero.
M	Number of terms used to determine the instantaneous elastic response. This variable is ignored with the new formulation but is kept for compatibility with the previous input.

Card 2	1	2	3	4	5	6	7	8
Variable	S0	E_MIN	E_MAX	GAMA1	GAMA2	K	EH	FORM
Type	F	F	F	F	F	F	F	I
Default	0.0	-0.9	5.1	0.0	0.0	0.0	0.0	0

VARIABLE	DESCRIPTION
SO	<p>Strain (logarithmic) output option to control what is written as component 7 to the d3plot database. (LS-PrePost always blindly labels this component as effective plastic strain.) The maximum values are updated for each element each time step:</p> <p>EQ.0.0: maximum principal strain that occurs during the calculation</p> <p>EQ.1.0: maximum magnitude of the principal strain values that occurs during the calculation</p> <p>EQ.2.0: maximum effective strain that occurs during the calculation</p>
E_MIN	<p>Minimum strain used to generate the load curve from C_i. The default range is -0.9 to 5.1. The computed solution will be more accurate if the user specifies the range used to fit the C_i. Linear extrapolation is used outside the specified range.</p>
E_MAX	<p>Maximum strain used to generate the load curve from C_i.</p>
GAMA1	<p>Material failure parameter (see *MAT_SIMPLIFIED_RUBBER and Figure M181-1)</p>
GAMA2	<p>Material failure parameter (see *MAT_SIMPLIFIED_RUBBER)</p>
K	<p>Material failure parameter that controls the volume enclosed by the failure surface (see *MAT_SIMPLIFIED_RUBBER):</p> <p>LE.0.0: ignore failure criterion</p> <p>GT.0.0: use actual K value for failure criterions</p>
EH	<p>Damage parameter (see *MAT_SIMPLIFIED_RUBBER)</p>
FORM	<p>Formulation of model.</p> <p>EQ.0: original model developed by Fung, which always relaxes to a zero stress state as time approaches infinity</p> <p>EQ.1: alternative model, which relaxes to the quasi-static elastic response</p> <p>EQ.-1: improvement on FORM = 0 where the instantaneous elastic response is used in the viscoelastic stress update, not just in the relaxation, as in FORM = 0. Consequently, the constants for the elastic response do not need to be scaled.</p>

VARIABLE**DESCRIPTION**

In general, formulations 1 and 2 won't give the same responses.

Viscoelastic Constants Card 1. Additional card for LC1 = 0.

Card 3	1	2	3	4	5	6	7	8
Variable	G1	BETA1	G2	BETA2	G3	BETA3	G4	BETA4
Type	F	F	F	F	F	F	F	F

Viscoelastic Constants Card 2. Additional card for LC1 = 0.

Card 4	1	2	3	4	5	6	7	8
Variable	G5	BETA5	G6	BETA6	G7	BETA7	G8	BETA8
Type	F	F	F	F	F	F	F	F

Viscoelastic Constants Card 3. Additional card for LC1 = 0.

Card 5	1	2	3	4	5	6	7	8
Variable	G9	BETA9	G10	BETA10	G11	BETA11	G12	BETA12
Type	F	F	F	F	F	F	F	F

VARIABLE**DESCRIPTION** G_i

Coefficients of the relaxation function. The number of coefficients is currently limited to 6 although 12 may be read in to maintain compatibility with the previous formulation's input. Define these coefficients if LC1 is set to zero. At least 2 coefficients must be non-zero.

 $BETA_i$

Decay constants of the relaxation function. Define these coefficients if LC1 is set to zero. The number of coefficients is currently limited to 6 although 12 may be read in to maintain compatibility with the previous formulation's input.

Instantaneous Elastic Responses Card. Additional card for LC2 = 0.

Card 6	1	2	3	4	5	6	7	8
Variable	C1	C2	C3	C4	C5	C6		
Type	F	F	F	F	F	F		

VARIABLE

DESCRIPTION

Ci Coefficients of the instantaneous elastic response in compression and tension. Define these coefficients only if LC2 is set to zero.

Remarks:

The equations for the original model (FORM = 0) are given as:

$$\sigma_V(t) = \int_0^t G(t - \tau) \frac{\partial \sigma_\epsilon[\epsilon(\tau)]}{\partial \epsilon} \frac{\partial \epsilon}{\partial \tau} d\tau$$

$$G(t) = \sum_{i=1}^n G_i e^{-\beta t}$$

$$\sigma_\epsilon(\epsilon) = \sum_{i=1}^k C_i \epsilon^i$$

where G is the shear modulus. Effective strain (which can be written to the d3plot database) is calculated as follows:

$$\epsilon^{eff} = \sqrt{\frac{2}{3} \epsilon_{ij} \epsilon_{ij}}$$

The polynomial for instantaneous elastic response should contain only odd terms if symmetric tension-compression response is desired.

The new model (FORM = 1) is based on the hyperelastic model used in *MAT_SIMPLIFIED_RUBBER assuming incompressibility. The one-dimensional expression for σ_ϵ generates the uniaxial stress-strain curve and an additional visco-elastic term is added on,

$$\sigma(\epsilon, t) = \sigma_{SR}(\epsilon) + \sigma_V(t)$$

$$\sigma_V(t) = \int_0^t G(t - \tau) \frac{\partial \epsilon}{\partial \tau} d\tau$$

where the first term to the right of the equals sign is the hyperelastic stress and the second is the viscoelastic stress. Unlike the previous formulation, where the stress always relaxed to zero, the current formulation relaxes to the hyperelastic stress.

*MAT_HILL_FOAM

Purpose: This is Material Type 177. This is a highly compressible foam based on the strain-energy function proposed by Hill [1979]; also see Storakers [1986]. Poisson’s ratio effects are taken into account.

Card Summary:

Card 1. This card is required.

MID	RO	K	N	MU	LCID	FITTYPE	LCSR
-----	----	---	---	----	------	---------	------

Card 2. This card is included if LCID = 0.

C1	C2	C3	C4	C5	C6	C7	C8
----	----	----	----	----	----	----	----

Card 3. This card is included if LCID = 0.

B1	B2	B3	B4	B5	B6	B7	B8
----	----	----	----	----	----	----	----

Card 4. This card is optional.

R	M						
---	---	--	--	--	--	--	--

Data Card Definitions:

Card 1	1	2	3	4	5	6	7	8
Variable	MID	RO	K	N	MU	LCID	FITTYPE	LCSR
Type	A	F	F	F	F	I	I	I
Default	none	none	none	0.	0.	0	0	0

VARIABLE

DESCRIPTION

MID	Material identification. A unique number or label must be specified (see *PART).
RO	Mass density
K	Bulk modulus. This modulus is used for determining the contact interface stiffness. See Remark 2.

VARIABLE	DESCRIPTION
N	Material constant. Define if LCID = 0 below; otherwise, N is fit from the load curve data. See Remark 2 .
MU	Damping coefficient.
LCID	Load curve ID that defines the force per unit area as a function of the stretch ratio. This curve can be given for either uniaxial or biaxial data depending on FITTYPE. See Remark 1 .
FITTYPE	Type of fit: EQ.1: Uniaxial data EQ.2: Biaxial data EQ.3: Pure shear data
LCSR	Load curve ID that defines the uniaxial or biaxial stretch ratio (see FITTYPE) as a function of the transverse stretch ratio.

Material Constant Card 1. Additional card for LCID = 0.

Card 2	1	2	3	4	5	6	7	8
Variable	C1	C2	C3	C4	C5	C6	C7	C8
Type	F	F	F	F	F	F	F	F
Default	0.0	0.0	0.0	0.0	0.0	0.0	0.0	0.0

VARIABLE	DESCRIPTION
<i>C_i</i>	Material constants. See equations below. Define up to 8 coefficients if LCID = 0.

Material Constant Card 2. Additional card for LCID = 0.

Card 3	1	2	3	4	5	6	7	8
Variable	B1	B2	B3	B4	B5	B6	B7	B8
Type	F	F	F	F	F	F	F	F
Default	0.0	0.0	0.0	0.0	0.0	0.0	0.0	0.0

VARIABLE

DESCRIPTION

B_i Material constants. See equations below. Define up to 8 coefficients if LCID = 0.

Mullins Effect Card. This card is optional.

Card 4	1	2	3	4	5	6	7	8
Variable	R	M						
Type	F	F						
Default	0.0	0.0						

VARIABLE

DESCRIPTION

R Mullins effect model *r* coefficient

M Mullins effect model *m* coefficient

Remarks:

- Load Curve Fit.** If load curve data is defined, the fit generated by LS-DYNA must be closely checked in the d3hsp output file. The nonlinear least squares procedure in LS-DYNA, which is used to fit the data, may be inadequate.
- Material Model.** The Hill strain energy density function for this highly compressible foam is given by:

$$W = \sum_{j=1}^m \frac{C_j}{b_j} \left[\lambda_1^{b_j} + \lambda_2^{b_j} + \lambda_3^{b_j} - 3 + \frac{1}{n} (J^{-nb_j} - 1) \right]$$

where C_j , b_j , and n are material constants. $J = \lambda_1\lambda_2\lambda_3$ and represents the ratio of the deformed to the undeformed state. The constant m is internally set to 4. If the number of points in the curve is less than 8, then m is set to the number of points divided by 2. The principal Cauchy stresses are:

$$t_i = \sum_{j=1}^m \frac{C_j}{J} [\lambda_i^{b_j} - J^{-nb_j}] \quad i = 1,2,3 .$$

From the above equations the shear modulus is:

$$\mu = \frac{1}{2} \sum_{j=1}^m C_j b_j ,$$

and the bulk modulus is:

$$K = 2\mu \left(n + \frac{1}{3} \right) .$$

LS-DYNA uses the value for K defined in the input in the calculation of contact forces and for the material time step. Generally, this value should be equal to or greater than the K given in the above equation.

***MAT_VISCOELASTIC_HILL_FOAM**

This is Material Type 178. This material is a highly compressible foam based on the strain-energy function proposed by Hill [1979]; also see Storakers [1986]. The extension to include large strain viscoelasticity is due to Feng and Hallquist [2002].

Card Summary:

Card 1. This card is required.

MID	RO	K	N	MU	LCID	FITTYPE	LCSR
-----	----	---	---	----	------	---------	------

Card 2. This card is required.

LCVE	NT	GSTART					
------	----	--------	--	--	--	--	--

Card 3. This card is defined if and only if LCID = 0.

C1	C2	C3	C4	C5	C6	C7	C8
----	----	----	----	----	----	----	----

Card 4. This card is defined if and only if LCID = 0.

B1	B2	B3	B4	B5	B6	B7	B8
----	----	----	----	----	----	----	----

Card 5. Include up to 12 of this card. The next keyword ("*") card terminates this input.

G_i	BETA $_i$						
-------	-----------	--	--	--	--	--	--

Data Card Definitions:

Card 1	1	2	3	4	5	6	7	8
Variable	MID	RO	K	N	MU	LCID	FITTYPE	LCSR
Type	A8	F	F	F	F	I	I	I
Default	none	none	none	0.0	0.05	0	0	0

VARIABLE**DESCRIPTION**

MID

Material identification. A unique number or label not exceeding 8 characters must be specified.

VARIABLE	DESCRIPTION
RO	Mass density
K	Bulk modulus. This modulus is used for determining the contact interface stiffness.
N	Material constant. Define if LCID = 0 below; otherwise, N is fit from the load curve data. See remarks below.
MU	Damping coefficient (0.05 < recommended value < 0.50)
LCID	Load curve ID that defines the force per unit area as a function of the stretch ratio. This curve can be given for either uniaxial or biaxial data depending on FITTYPE. Load curve LCSR below must also be defined.
FITTYPE	Type of fit: EQ.1: uniaxial data EQ.2: biaxial data
LCSR	Load curve ID that defines the uniaxial or biaxial stress ratio (see FITTYPE) as a function of the transverse stretch ratio

Card 2	1	2	3	4	5	6	7	8
Variable	LCVE	NT	GSTART					
Type	I	I	F					
Default	0	6	1/TMAX					

VARIABLE	DESCRIPTION
LCVE	Optional load curve ID that defines the relaxation function in shear. This curve is used to fit the coefficients G_i and $BETA_i$ (see Card 5). If zero, define the coefficients directly (recommended).

VARIABLE	DESCRIPTION
----------	-------------

NT	Number of terms used to fit the Prony series, which must be less than or equal to 12. This number should be equal to the number of decades of time covered by the experimental data. Define this number if LCVE is nonzero. Carefully check the fit in the d3hsp file to ensure that it is valid, since the least square fit is not always reliable.
----	--

GSTART	Starting value for the least squares fit. If zero, a default value is set equal to the inverse of the largest time in the experiment. Define this number if LCVE is nonzero. See remarks below.
--------	---

Material Constant Card 1. Additional card for LCID = 0

Card 3	1	2	3	4	5	6	7	8
Variable	C1	C2	C3	C4	C5	C6	C7	C8
Type	F	F	F	F	F	F	F	F

Material Constant Card 2. Additional card for LCID = 0

Card 4	1	2	3	4	5	6	7	8
Variable	B1	B2	B3	B4	B5	B6	B7	B8
Type	F	F	F	F	F	F	F	F

VARIABLE	DESCRIPTION
----------	-------------

C_i	Material constants. See remarks below. Define up to 8 coefficients.
-------	---

B_i	Material constants. See remarks below. Define up to 8 coefficients.
-------	---

Viscoelastic Constant Cards. Up to 12 cards may be input. The next keyword ("*") card terminates this input.

Card 5	1	2	3	4	5	6	7	8
Variable	G_i	BETA <i>i</i>						
Type	F	F						

VARIABLE**DESCRIPTION**

G_i	Optional shear relaxation modulus for the i^{th} term
BETA <i>i</i>	Optional decay constant if i^{th} term

Remarks:

If load curve data is defined, the fit generated by LS-DYNA must be closely checked in the d3hsp output file. It may occur that the nonlinear least squares procedure in LS-DYNA, which is used to fit the data, is inadequate.

The Hill strain energy density function for this highly compressible foam is given by:

$$W = \sum_{j=1}^n \frac{C_j}{b_j} \left[\lambda_1^{b_j} + \lambda_2^{b_j} + \lambda_3^{b_j} - 3 + \frac{1}{n} (J^{-nb_j} - 1) \right],$$

where C_j , b_j , and n are material constants and $J = \lambda_1 \lambda_2 \lambda_3$ represents the ratio of the deformed to the undeformed state. The principal Cauchy stresses are

$$\tau_{ii} = \sum_{j=1}^n \frac{C_j}{J} \left[\lambda_i^{b_j} - J^{-nb_j} \right] \quad i = 1, 2, 3$$

From the above equations the shear modulus is:

$$\mu = \frac{1}{2} \sum_{j=1}^m C_j b_j$$

and the bulk modulus is:

$$K = 2\mu \left(n + \frac{1}{3} \right)$$

The value for K defined in the input is used in the calculation of contact forces and for the material time step. Generally, this value should be equal to or greater than the K given in the above equation.

Rate effects are taken into account through linear viscoelasticity by a convolution integral of the form:

$$\sigma_{ij} = \int_0^t g_{ijkl}(t - \tau) \frac{\partial \varepsilon_{kl}}{\partial \tau} d\tau ,$$

or in terms of the second Piola-Kirchhoff stress, S_{ij} , and Green's strain tensor, E_{ij} ,

$$S_{ij} = \int_0^t G_{ijkl}(t - \tau) \frac{\partial E_{kl}}{\partial \tau} d\tau ,$$

where $g_{ijkl}(t - \tau)$ and $G_{ijkl}(t - \tau)$ are the relaxation functions for the different stress measures. This stress is added to the stress tensor determined from the strain energy functional.

If we wish to include only simple rate effects, the relaxation function is represented by six terms from the Prony series:

$$g(t) = \alpha_0 + \sum_{m=1}^N \alpha_m e^{-\beta_m t}$$

given by,

$$g(t) = \sum_{i=1}^n G_i e^{-\beta_i t}$$

This model is effectively a Maxwell fluid which consists of a dampers and springs in series. We characterize this in the input by shear moduli, G_i , and decay constants, β_i . The viscoelastic behavior is optional and an arbitrary number of terms may be used.

***MAT_LOW_DENSITY_SYNTHETIC_FOAM_{OPTION}**

This is Material Type 179 (and 180 if the ORTHO option below is active) for modeling rate independent low density foams, which have the property that the hysteresis in the loading-unloading curve is considerably reduced after the first loading cycle. For this material we assume that the loading-unloading curve is identical after the first cycle of loading is completed and that the damage is isotropic, that is, the behavior after the first cycle of loading in the orthogonal directions also follows the second curve. The main application at this time is to model the observed behavior in the compressible synthetic foams that are used in some bumper designs. Tables may be used in place of load curves to account for strain rate effects.

Available options include:

<BLANK>

ORTHO

WITH_FAILURE

ORTHO_WITH_FAILURE

If the foam develops orthotropic behavior, that is, after the first loading and unloading cycle the material in the orthogonal directions are unaffected, then the ORTHO option should be used. If the ORTHO option is active the directionality of the loading is stored. This option requires additional storage for history variables related to the orthogonality and is slightly more expensive.

An optional failure criterion is included. A description of the failure model is provided below for material type 181, *MAT_SIMPLIFIED_RUBBER/FOAM.

Card Summary:

Card 1. This card is required.

MID	RO	E	LCID1	LCID2	HU	BETA	DAMP
-----	----	---	-------	-------	----	------	------

Card 2. This card is required.

SHAPE	FAIL	BVFLAG	ED	BETA1	KCON	REF	TC
-------	------	--------	----	-------	------	-----	----

Card 3. This card is included if LCID < 0.

RFLAG	DTRT						
-------	------	--	--	--	--	--	--

Card 4. This card is included if and only if the IF_FAILURE keyword option is used.

K	GAMA1	GAMA2	EH				
---	-------	-------	----	--	--	--	--

Data Card Definitions:

Card 1	1	2	3	4	5	6	7	8
Variable	MID	RO	E	LCID1	LCID2	HU	BETA	DAMP
Type	A8	F	F	F	F	F	F	F
Default	none	none	none	none	none	1.	none	0.05

VARIABLE**DESCRIPTION**

MID	Material identification. A unique number or label not exceeding 8 characters must be specified.
RO	Mass density
E	Young's modulus. This modulus is used if the elongations are tensile as described for the *MAT_LOW_DENSITY_FOAM.
LCID1	Load curve or table ID describing nominal stress as a function of strain for the undamaged material (see Remark 2): <p>GT.0: Load curve ID (see *DEFINE_CURVE) for nominal stress as a function of strain for the undamaged material.</p> <p>LT.0: -LCID1 is a table ID (see *DEFINE_TABLE) for nominal stress as a function of strain for the undamaged material as a function of strain rate</p>
LCID2	Load curve or table ID. The load curve ID (see *DEFINE_CURVE) defines the nominal stress as a function of strain for the damaged material. The table ID (see *DEFINE_TABLE) defines the nominal stress as a function of strain for the damaged material as a function of strain rate. See Remark 2 .
HU	Hysteretic unloading factor between 0.0 and 1.0 (default = 1.0, that is, no energy dissipation); see Figure M179-1 and Remarks 1 and 2 .
BETA	Decay constant to model creep in unloading, β
DAMP	Viscous coefficient ($.05 < \text{recommended value} < .50$) to model damping effects.

VARIABLE**DESCRIPTION**

LT.0.0: |DAMP| is the load curve ID that defines the damping constant as a function of the maximum strain in compression defined as:

$$\varepsilon_{\max} = \max(1 - \lambda_1, 1 - \lambda_2, 1 - \lambda_3) .$$

In tension, the damping constant is set to the value corresponding to the strain at 0.0. The abscissa should be defined from 0.0 to 1.0.

Card 2	1	2	3	4	5	6	7	8
Variable	SHAPE	FAIL	BVFLAG	ED	BETA1	KCON	REF	TC
Type	F	F	F	F	F	F	F	F
Default	1.0	0.0	0.0	0.0	0.0	0.0	0.0	10 ²⁰

VARIABLE**DESCRIPTION**

SHAPE

Shape factor for unloading. Active for nonzero values of the hysteretic unloading factor. Values less than one reduce the energy dissipation and greater than one increase dissipation; see also [Figure M179-1](#) and [Remarks 1](#) and [2](#).

FAIL

Failure option after cutoff stress is reached:

EQ.0.0: tensile stress remains at cut-off value,

EQ.1.0: tensile stress is reset to zero.

BVFLAG

Bulk viscosity activation flag:

EQ.0.0: no bulk viscosity (recommended),

EQ.1.0: bulk viscosity active.

ED

Optional Young's relaxation modulus, E_d , for rate effects.

BETA1

Optional decay constant, β_1 .

VARIABLE	DESCRIPTION
KCON	Stiffness coefficient for contact interface stiffness. If undefined, the maximum slope in the stress as a function of strain curve is used. When the maximum slope is used for the contact, the time step size for this material is reduced for stability. In some cases, Δt may be significantly smaller, so defining a reasonable stiffness is recommended.
REF	Use reference geometry to initialize the stress tensor. The reference geometry is defined by the keyword *INITIAL_FOAM_REFERENCE_GEOMETRY. EQ.0.0: Off EQ.1.0: On
TC	Tension cut-off stress

Additional card for LCID1 < 0.

Card 3	1	2	3	4	5	6	7	8
Variable	RFLAG	DTRT						
Type	F	F						
Default	0.0	0.0						

VARIABLE	DESCRIPTION
RFLAG	Rate type for input: EQ.0.0: LCID1 and LCID2 should be input as functions of true strain rate. EQ.1.0: LCID1 and LCID2 should be input as functions of engineering strain rate.
DTRT	Strain rate averaging flag: EQ.0.0: Use weighted running average. LT.0.0: Average the last 11 values. GT.0.0: Average over the last DTRT time units.

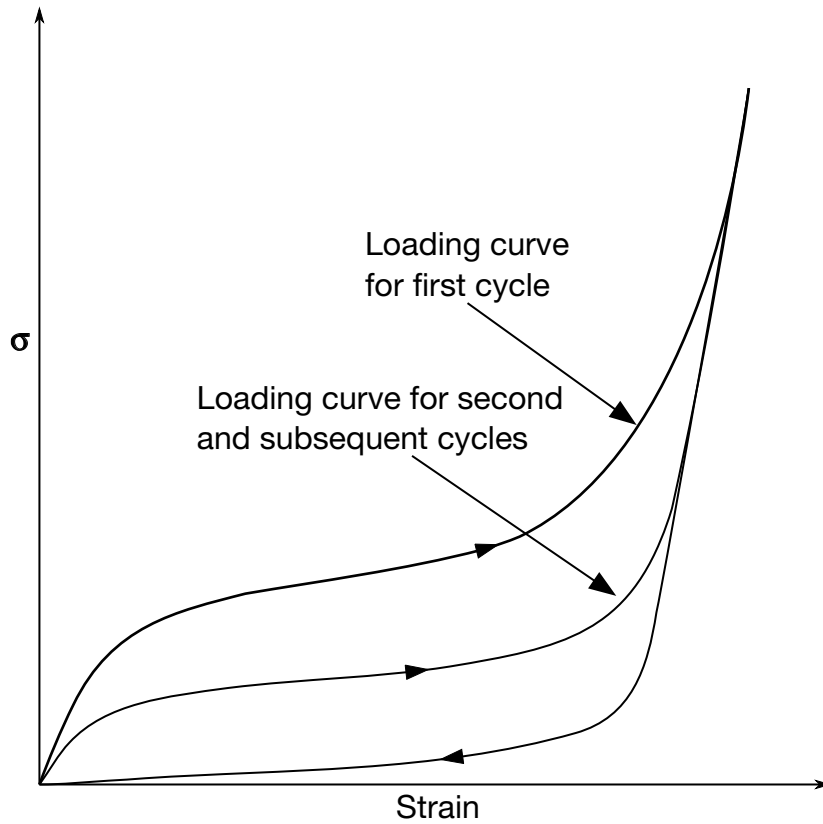

Figure M179-1. Loading and reloading curves.

Additional card for WITH_FAILURE keyword option.

Card 4	1	2	3	4	5	6	7	8
Variable	K	GAMA1	GAMA2	EH				
Type	F	F	F	F				

VARIABLE

DESCRIPTION

K Material failure parameter that controls the volume enclosed by the failure surface.

LE.0.0: ignore failure criterion;

GT.0.0: use actual K value for failure criterions.

GAMA1 Material failure parameter; see [Figure M181-1](#).

GAMA2 Material failure parameter

EH Damage parameter

Remarks:

1. **Uniaxial Response.** This model is based on *MAT_LOW_DENSITY_FOAM. The uniaxial response is shown in [Figure M179-1](#) with a large shape factor and small hysteretic factor. If the shape factor is not used, the unloading will occur on the loading curve for the second and subsequent cycles.
2. **Damage and Hysteresis.** The damage is defined as the ratio of the current volume strain to the maximum volume strain, and it is used to interpolate between the responses defined by LCID1 and LCID2.

HU defines a hysteretic scale factor that is applied to the stress interpolated from LCID1 and LCID2,

$$\sigma = \left[HU + (1 - HU) \times \min \left(1, \frac{e_{\text{int}}}{e_{\text{int}}^{\text{max}}} \right)^S \right] \sigma(\text{LCID1}, \text{LCID2})$$

where e_{int} is the internal energy and S is the shape factor. Setting HU to 1 results in a scale factor of 1. Setting HU close to zero scales the stress by the ratio of the internal energy to the maximum internal energy raised to the power S , resulting in the stress being reduced when the strain is low.

***MAT_SIMPLIFIED_RUBBER/FOAM_{OPTION}**

This is Material Type 181. This material model provides a rubber and foam model specified with a single uniaxial load curve or a family of uniaxial curves at discrete strain rates. Hysteretic unloading may optionally be modeled through a single uniaxial unloading curve or a two-parameter formulation. Specifying a Poisson's ratio greater than 0.0 and less than 0.49 activates the foam formulation. This material may be used with both shell and solid elements.

Available options include:

<BLANK>

WITH_FAILURE

LOG_LOG_INTERPOLATION

When the WITH_FAILURE keyword option is active, a strain-based failure surface is defined that is suitable for incompressible polymers. It models failure in both tension and compression. With LOG_LOG_INTERPOLATION, LS-DYNA interpolates the strain rate effect in the table TBID using log-log interpolation.

This material law has been developed at DaimlerChrysler, Sindelfingen, in collaboration with Paul Du Bois, LSTC, and Prof. Dave J. Benson, UCSD.

Card Summary:

Card 1. This card is required.

MID	RO	KM	MU	G	SIGF	REF	PRTEN
-----	----	----	----	---	------	-----	-------

Card 2. This card is required.

SGL	SW	ST	LC/TBID	TENSION	RTYPE	AVGOPT	PR
-----	----	----	---------	---------	-------	--------	----

Card 3. This card is included if the WITH_FAILURE keyword option is used.

K	GAMA1	GAMA2	EH				
---	-------	-------	----	--	--	--	--

Card 4. This card is optional. It must be included if Card 5 is included.

LCUNLD	HU	SHAPE	STOL	VISCO	HISOUT		
--------	----	-------	------	-------	--------	--	--

Card 5. This card is optional. Up to 12 cards in this format may be input. If fewer than 12 cards are input, the next keyword ("*") card terminates this input.

<i>G_i</i>	BETA _{<i>i</i>}	VFLAG						
----------------------	--------------------------	-------	--	--	--	--	--	--

Data Card Definitions:

Card 1	1	2	3	4	5	6	7	8
Variable	MID	RO	KM	MU	G	SIGF	REF	PRTEN
Type	A	F	F	F	F	F	F	F

VARIABLE

DESCRIPTION

MID	Material identification. A unique number or label must be specified (see *PART).
RO	Mass density
KM	Linear bulk modulus (see PR on Card 2)
MU	Damping coefficient (0.05 < recommended value < 0.50; default is 0.10).
G	Shear modulus for frequency independent damping. Frequency independent damping is based on a spring and slider in series. The critical stress for the slider mechanism is SIGF defined below. For the best results, the value of G should be 250-1000 times greater than SIGF. See Remark 1 .
SIGF	Limit stress for frequency independent, frictional damping. See Remark 1 .
REF	Use reference geometry to initialize the stress tensor. The reference geometry is defined by the keyword: *INITIAL_FOAM_REFERENCE_GEOMETRY (see there for more details). EQ.0.0: Off EQ.1.0: On

VARIABLE**DESCRIPTION**

PRTEN

The tensile Poisson's ratio for shells (optional). If PRTEN is zero, PR will serve as the Poisson's ratio for both tension and compression in shells. If PRTEN is nonzero, PR will serve only as the compressive Poisson's ratio for shells.

Card 2	1	2	3	4	5	6	7	8
Variable	SGL	SW	ST	LC/TBID	TENSION	RTYPE	AVGOPT	PR
Type	F	F	F	F	F	F	F	F

VARIABLE**DESCRIPTION**

SGL

Specimen gauge length

SW

Specimen width

ST

Specimen thickness

LC/TBID

Load curve ID or table ID (see *DEFINE_TABLE) giving the force as a function of the actual change in the gauge length. If SGL, SW, and ST are set to unity (1.0), then curve LC is also engineering stress versus engineering strain. If the table definition is used, a family of curves is defined for discrete strain rates. The curves should cover the complete range of expected response, including both compressive (negative values) and tensile (positive values) regimes.

TENSION

Parameter that controls how the rate effects are treated. Applicable to the table definition.

EQ.-1.0: Rate effects are considered during tension and compression loading, but not during unloading.

EQ.0.0: Rate effects are considered for compressive loading only.

EQ.1.0: Rate effects are treated identically in tension and compression.

RTYPE

Strain rate type if a table is defined:

EQ.0.0: True strain rate

VARIABLE	DESCRIPTION
	EQ.1.0: Engineering strain rate
AVGOPT	<p>Averaging option for strain rates to reduce numerical noise:</p> <p>LT.0.0: AVGOPT is a time window/interval over which the strain rates are averaged.</p> <p>EQ.0.0: Simple average of 12 time steps</p> <p>EQ.1.0: Running average of last 12 averages</p>
PR	<p>Poisson ratio or viscosity coefficient:</p> <p>LE.0.0: An incompressible rubber material is assumed, using the Ogden strain-energy functional. PR is set to 0.495 internally for computing the time-step only and is not used otherwise. Compressibility is defined using KM. For $PR < 0$ in solid elements, an incrementally updated mean viscous stress develops according to the following equation with $\beta = PR$ and $K_m = KM$ (see Card 1):</p> $p^{n+1} = p^n e^{-\beta \Delta t} + K_m \dot{\epsilon}_{kk} \left(\frac{1 - e^{-\beta \Delta t}}{\beta} \right) .$ <p>GT.0.0.AND.LT.0.49: A foam material is assumed, using the Hill strain-energy function. PR gives Poisson's ratio. KM on Card 1 is ignored. Selective-reduced integration is <i>not</i> used for fully-integrated elements.</p> <p>GE.0.49.AND.LT.0.5: An incompressible rubber material is assumed, using the Ogden strain-energy functional. PR is used for computing the time-step only. Compressibility is defined using KM on Card 1. Selective-reduced integration is not used for fully-integrated elements.</p>

Additional card required for WITH_FAILURE option. Otherwise skip this card.

Card 3	1	2	3	4	5	6	7	8
Variable	K	GAMA1	GAMA2	EH				
Type	F	F	F	F				

VARIABLE**DESCRIPTION**

K Material failure parameter that controls the volume enclosed by the failure surface.

LE.0.0: Ignore failure criterion.

GT.0.0: Use actual K value for failure criterion (see [Remark 2](#)).

GAMA1 Material failure parameter, Γ_1 ; see [Remark 2](#) and [Figure M181-1](#).

GAMA2 Material failure parameter, Γ_2 ; see [Remark 2](#).

EH Damage parameter, h . See [Remark 2](#).

Optional Parameter Card.

Card 4	1	2	3	4	5	6	7	8
Variable	LCUNLD	HU	SHAPE	STOL	VISCO	HISOUT		
Type	F	F	F	F	F	F		

VARIABLE**DESCRIPTION**

LCUNLD Optional load curve (see *DEFINE_CURVE) giving the force as a function of actual length during unloading. The unload curve should cover exactly the same range as LC or the load curves of TBID and its end points should have identical values. In other words, the combination of LC and LCUNLD or the first curve of TBID and LCUNLD describes a complete cycle of loading and unloading. See also material *MAT_083.

HU Hysteretic unloading factor between 0 and 1 (default = 1.0, meaning no energy dissipation). See also material *MAT_083 and [Figure M57-1](#). This option is ignored if LCUNLD is used.

VARIABLE	DESCRIPTION
SHAPE	Shape factor for unloading. Active for nonzero values of the hysteretic unloading factor HU. Values less than one reduces the energy dissipation and greater than one increases dissipation. See also material *MAT_083 and Figure M57-1 .
STOL	Tolerance in stability check. See Remark 3 .
VISCO	Flag to invoke viscoelastic formulation. The viscoelastic formulation does not apply to shell elements and will be ignored for shells. See Remark 4 . EQ.0.0: Purely elastic EQ.1.0: Viscoelastic formulation (solids only)
HISOUT	History output flag. EQ.0.0: Default EQ.1.0: Principal strains are written to history variables 25, 26, and 27.

Optional Viscoelastic Constants Cards. Up to 12 cards in format 5 may be input. A keyword card (with a "*" in column 1) terminates this input if fewer than 12 cards are used.

Card 5	1	2	3	4	5	6	7	8
Variable	G_i	BETA i	VFLAG					
Type	F	F	I					
Default	none	none	0					

VARIABLE	DESCRIPTION
G_i	Optional shear relaxation modulus for the i^{th} term. The G_i and BETA i terms are used only for solid elements when VISCO = 1. See Remark 4 .
BETA i	Optional decay constant if i^{th} term. See Remark 4 .
VFLAG	Type of viscoelasticity formulation. This appears only on the first line defining G_i , BETA i , and VFLAG. See Remark 4 .

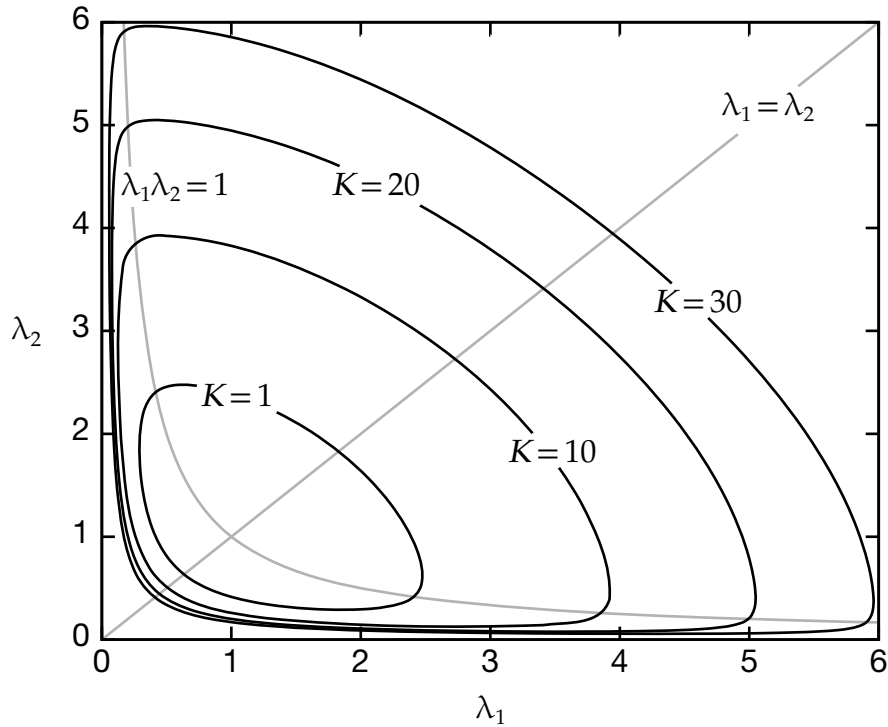
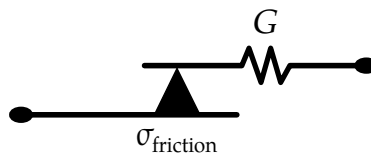

Figure M181-1. Failure surface for polymer for $\Gamma_1 = 0$ and $\Gamma_2 = 0.02$.

VARIABLE	DESCRIPTION
	EQ.0: Standard viscoelasticity formulation (default)
	EQ.1: Viscoelasticity formulation using instantaneous elastic stress

Remarks:

1. **Frequency Independent Damping.** Frequency independent damping is obtained by the having a spring and slider in series as shown in the following sketch:



2. **Failure Criterion for Polymers.** The general failure criterion for polymers is proposed by Feng and Hallquist as

$$f(I_1, I_2, I_3) = (I_1 - 3) + \Gamma_1(I_1 - 3)^2 + \Gamma_2(I_2 - 3) = K$$

where K is a material parameter which controls the size enclosed by the failure surface. I_1 , I_2 and I_3 are the three invariants of right Cauchy-Green deformation tensor (\mathbf{C}):

$$\begin{aligned}
 I_1 &= C_{ii} = \lambda_1^2 + \lambda_2^2 + \lambda_3^2 \\
 I_2 &= \frac{1}{2}(C_{ii}C_{jj} - C_{ij}C_{ij}) = \lambda_1^2 \lambda_2^2 + \lambda_1^2 \lambda_3^2 + \lambda_2^2 \lambda_3^2 \\
 I_3 &= \det(\mathbf{C}) = \lambda_1^2 \lambda_2^2 \lambda_3^2
 \end{aligned}$$

with λ_i as the stretch ratios in the three principal directions.

To avoid sudden failure and numerical difficulty, material failure, which is usually a time point, is modeled as a process of damage growth. In this case, the two threshold values are chosen as $(1 - h)K$ and K , where h (also called EH) is a small number chosen based on experimental results reflecting the range between damage initiation and material failure.

The damage is defined as function of f :

$$D = \begin{cases} 0 & \text{if } f \leq (1 - h)K \\ \frac{1}{2} \left[1 + \cos \frac{\pi(f - K)}{hK} \right] & \text{if } (1 - h)K < f < K \\ 1 & \text{if } f \geq K \end{cases}$$

With this definition, damage is first-order continuous, and the tangent stiffness matrix will be continuous. The reduced stress considering damage effect is

$$\sigma_{ij} = (1 - D)\sigma_{ij}^o$$

where σ_{ij}^o is the undamaged stress. Prior to final failure, material damage is assumed to be recoverable. Once material failure occurs, damage will become permanent.

3. **Stability of the Stress-Strain Response.** Bad choices of curves for the stress-strain response may lead to an unstable model. LS-DYNA can check for stability given a certain tolerance with the field STOL. The check is done by examining the eigenvalues of the tangent modulus at selected stretch points. A warning message is issued if an eigenvalue is less than $-\text{STOL} \times \text{BULK}$, where BULK indicates the bulk modulus of the material. For $\text{STOL} < 0$, the check is disabled. Otherwise, it should be chosen with care. A too small value may detect instabilities that are insignificant in practice. To avoid significant instabilities, we recommend using smooth curves. At best the curves should be continuously differentiable. For the incompressible case, a sufficient condition for stability is that the stress-stretch curve $S(\lambda)$ can be written as

$$S(\lambda) = H(\lambda) - \frac{H\left(\frac{1}{\sqrt{\lambda}}\right)}{\lambda\sqrt{\lambda}}$$

where $H(\lambda)$ is a function with $H(1) = 0$ and $H'(\lambda) > 0$.

4. **Viscoelasticity.** For solid elements, rate effects may also be taken into account through linear viscoelasticity by setting $VISCO = 1.0$. For $VFLAG = 0$, viscoelasticity is modeled through a convolution integral of the form:

$$\sigma_{ij} = \int_0^t g_{ijkl}(t - \tau) \frac{\partial \varepsilon_{kl}}{\partial \tau} d\tau ,$$

or in terms of the second Piola-Kirchhoff stress, \mathbf{S}_0 , and Green's strain tensor, \mathbf{E}_{RT}

$$S_{ij} = \int_0^t G_{ijkl}(t - \tau) \frac{\partial E_{kl}}{\partial \tau} d\tau .$$

Here $g_{ijkl}(t - \tau)$ and $G_{ijkl}(t - \tau)$ are the relaxation functions for the different stress measures. This stress is added to the stress tensor determined from the strain energy functional.

The relaxation function is represented by six terms from the Prony series:

$$g(t) = \alpha_0 + \sum_{m=1}^N \alpha_m e^{-\beta t}$$

given by

$$g(t) = \sum_{i=1}^n G_i e^{-\beta_i t} .$$

This model is effectively a Maxwell fluid which consists of a dampers and springs in series. We characterize this in the input by shear moduli, G_i , and decay constants, β_i . An arbitrary number of terms may be used.

For $VFLAG = 1$, the viscoelastic term is

$$\sigma_{ij} = \int_0^t g_{ijkl}(t - \tau) \frac{\partial \sigma_{kl}^E}{\partial \tau} d\tau$$

where σ_{kl}^E is the instantaneous stress evaluated from the internal energy functional. The coefficients in the Prony series, therefore, correspond to normalized relaxation moduli instead of elastic moduli.

***MAT_SIMPLIFIED_RUBBER_WITH_DAMAGE**

An available options includes:

LOG_LOG_INTERPOLATION

This is Material Type 183. This material model provides an incompressible rubber model defined by a single uniaxial load curve for loading (or a table if rate effects are considered) and a single uniaxial load curve for unloading. This model is similar to *MAT_-181/*MAT_SIMPLIFIED_RUBBER/FOAM. This material may be used with both shell and solid elements.

This material law has been developed at DaimlerChrysler, Sindelfingen, in collaboration with Paul Du Bois, LSTC, and Prof. Dave J. Benson, UCSD.

Card 1	1	2	3	4	5	6	7	8
Variable	MID	RO	K	MU	G	SIGF		
Type	A8	F	F	F	F	F		

Card 2	1	2	3	4	5	6	7	8
Variable	SGL	SW	ST	LC / TBID	TENSION	RTYPE	AVGOPT	
Type	F	F	F	F	F	F	F	

Card 3	1	2	3	4	5	6	7	8
Variable	LCUNLD	REF	STOL					
Type	F	F	F					

VARIABLE

DESCRIPTION

MID Material identification. A unique number or label not exceeding 8 characters must be specified.

RO Mass density

VARIABLE	DESCRIPTION
K	Linear bulk modulus.
MU	Damping coefficient.
G	Shear modulus for frequency independent damping. Frequency independent damping is based of a spring and slider in series. The critical stress for the slider mechanism is SIGF defined below. For the best results, the value of G should be 250-1000 times greater than SIGF.
SIGF	Limit stress for frequency independent, frictional, damping.
SGL	Specimen gauge length
SW	Specimen width
ST	Specimen thickness
LC/TBID	Load curve ID or table ID, see *DEFINE_TABLE, defining the force versus actual change in the gauge length. If SGL, SW, and ST are set to unity (1.0), then curve LC is also engineering stress versus engineering strain. If the table definition is used, a family of curves is defined for discrete strain rates. The curves should cover the complete range of expected response, including both compressive (negative values) and tensile (positive values) regimes.
TENSION	Parameter that controls how the rate effects are treated. Applicable to the table definition. EQ.-1.0: rate effects are considered during tension and compression loading, but not during unloading, EQ.0.0: rate effects are considered for compressive loading only, EQ.1.0: rate effects are treated identically in tension and compression.
RTYPE	Strain rate type if a table is defined: EQ.0.0: true strain rate, EQ.1.0: engineering strain rate

VARIABLE	DESCRIPTION
AVGOPT	Averaging option determine strain rate to reduce numerical noise. EQ.0.0: simple average of twelve time steps, EQ.1.0: running 12 point average.
LCUNLD	Load curve, see *DEFINE_CURVE, defining the force versus actual change in the gauge length during unloading. The unload curve should cover exactly the same range as LC (or as the first curve of table TBID) and its end points should have identical values, i.e., the combination of LC (or as the first curve of table TBID) and LCUNLD describes a complete cycle of loading and unloading.
REF	Use reference geometry to initialize the stress tensor. The reference geometry is defined by the keyword:*INITIAL_FOAM_REFERENCE_GEOMETRY (see there for more details). EQ.0.0: off, EQ.1.0: on.
STOL	Tolerance in stability check, see remark 2 .

Remarks:

1. The LOG_LOG_INTERPOLATION option interpolates the strain rate effect in the table TBID using log-log interpolation.
2. Bad choice of curves for the stress-strain response may lead to an unstable model, and there is an option to check this to a certain tolerance level, see dimensionless parameter STOL. The check is done by examining the eigenvalues of the tangent modulus at selected stretch points and a warning message is issued if an eigenvalue is less than $-STOL \times BULK$, where BULK indicates the bulk modulus of the material. For $STOL < 0$ the check is disabled, otherwise it should be chosen with care, a too small value may detect instabilities that are insignificant in practice. To avoid significant instabilities it is recommended to use smooth curves, at best the curves should be continuously differentiable, in fact for the incompressible case, a sufficient condition for stability is that the stress-stretch curve $S(\lambda)$ can be written as

$$S(\lambda) = H(\lambda) - \frac{H(\frac{1}{\sqrt{\lambda}})}{\lambda\sqrt{\lambda}}$$

where $H(\lambda)$ is a function with $H(1) = 0$ and $H'(\lambda) > 0$.

***MAT_COHESIVE_ELASTIC**

This is Material Type 184. It is a simple cohesive elastic model for use with cohesive element formulations; see the field ELFORM in *SECTION_SOLID and *SECTION_SHELL.

Card 1	1	2	3	4	5	6	7	8
Variable	MID	RO	ROFLG	INTFAIL	ET	EN	FN_FAIL	FT_FAIL
Type	A	F	F	F	F	F	F	F

VARIABLE**DESCRIPTION**

MID	Material identification. A unique number or label must be specified (see *PART).
RO	Mass density
ROFLG	Flag for whether density is specified per unit area or volume: EQ.0: Specifies the density is per unit volume (default) EQ.1: Specifies the density is per unit area for controlling the mass of cohesive elements with an initial volume of zero
INTFAIL	The number of integration points required for the cohesive element to be deleted. The value of INTFAIL may range from 1 to 4 with 1 the recommended value. LT.0.0: Employs a Newton-Cotes integration scheme, and the element will be deleted when INTFAIL integration points have failed. EQ.0.0: Employs a Newton-Cotes integration scheme, and the element will <i>not</i> be deleted even if it satisfies the failure criterion. GT.0.0: Employs a Gauss integration scheme, and the element will be deleted when INTFAIL integration points have failed.
ET	Stiffness in the plane of the cohesive element
EN	Stiffness normal to the plane of the cohesive element
FN_FAIL	Traction in the normal direction for tensile failure

VARIABLE	DESCRIPTION
FT_FAIL	Traction in the tangential direction for shear failure

Remarks:

This material cohesive model outputs three tractions having units of force per unit area into the d3plot database rather than the usual six stress components. The in-plane shear traction along the 1-2 edge replaces the x -stress, the orthogonal in plane shear traction replaces the y -stress, and the traction in the normal direction replaces the z -stress.

***MAT_COHESIVE_TH**

This is Material Type 185. It is a cohesive model by Tvergaard and Hutchinson [1992] for use with cohesive element formulations; see the variable ELFORM in *SECTION_SOLID and *SECTION_SHELL. The implementation is based on the description of the implementation in the Sandia National Laboratory code, Tahoe [2003].

Card 1	1	2	3	4	5	6	7	8
Variable	MID	RO	ROFLG	INTFAIL	SIGMAX	NLS	TLS	TLS2
Type	A	F	F	F	F	F	F	F

Card 2	1	2	3	4	5	6	7	8
Variable	LAMDA1	LAMDA2	LAMDAF	STFSF	ISW	ALPHA1	ALPHA2	
Type	F	F	F	F	I	F	F	

Additional card that may be used for XFEM shells; see *SECTION_SHELL_XFEM.

Card 3	1	2	3	4	5	6	7	8
Variable	DR	ALPHA3						
Type	F	F						

VARIABLE**DESCRIPTION**

MID	Material identification. A unique number or label must be specified (see *PART).
RO	Mass density
ROFLG	Flag for whether density is specified per unit area or volume. EQ.0: Specifies density per unit volume (default) EQ.1: Specifies the density is per unit area for controlling the mass of cohesive elements with an initial volume of zero

VARIABLE	DESCRIPTION
INTFAIL	<p>The number of integration points required for the cohesive element to be deleted. The value of INTFAIL may range from 1 to 4 with 1 as the recommended value.</p> <p>LT.0.0: Employs a Newton-Cotes integration scheme. The element will be deleted when INTFAIL integration points have failed.</p> <p>EQ.0.0: Employs a Newton-Cotes integration scheme. The element will <i>not</i> be deleted even if it satisfies the failure criterion.</p> <p>GT.0.0: Employs a Gauss integration scheme. The element will be deleted when INTFAIL integration points have failed.</p>
SIGMAX	Peak traction
NLS	Length scale (maximum separation) in the normal direction
TLS	Length scale (maximum separation) in the tangential direction
LAMDA1	Scaled distance to peak traction (Λ_1)
LAMDA2	Scaled distance to beginning of softening (Λ_2).
LAMDAAF	Scaled distance for failure (Λ_{fail})
STFSF	<p>Penetration stiffness multiplier. The penetration stiffness, PS, in terms of input parameters becomes:</p> $PS = \frac{STFSF \times SIGMAX}{NLS \times \left(\frac{LAMDA1}{LAMDAAF} \right)}$
TLS2	Length scale (maximum separation) in the tear direction (for XFEM shells only). See Remark 2 .
ISW	<p>Cohesive law for XFEM shells only (see Remark 2):</p> <p>EQ.-1: Initially rigid cohesive law (type I)</p> <p>EQ.-2: Initially rigid cohesive law (type II)</p>
ALPHA1	Ratio of maximum mode II shear traction to normal traction (for XFEM shells only)

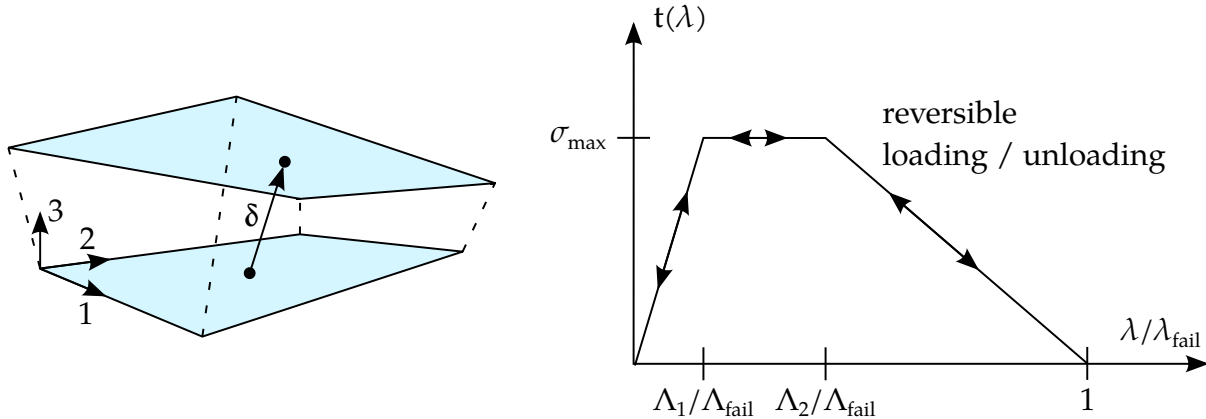

Figure M185-1. Relative displacement and trilinear traction-separation law

VARIABLE	DESCRIPTION
ALPHA2	Ratio of maximum mode III shear traction to normal traction (for XFEM shells only)
DR	Critical rotation scale (for XFEM shells only)
ALPHA3	Ratio of maximum bending moment to normal traction (for XFEM shells only)

Material Model:

In this cohesive material model, we use a dimensionless separation measure, λ , for the interaction between relative displacements in the normal (δ_3 - mode I) and tangential (δ_1, δ_2 - mode II) directions (see [Figure M185-1](#) left):

$$\lambda = \sqrt{\left(\frac{\delta_1}{\text{TLS}}\right)^2 + \left(\frac{\delta_2}{\text{TLS}}\right)^2 + \left(\frac{\langle \delta_3 \rangle}{\text{NLS}}\right)^2}$$

The Macaulay brackets distinguish between tension ($\delta_3 \geq 0$) and compression ($\delta_3 < 0$). NLS and TLS are critical values, representing the maximum separations in the interface in the normal and tangential directions. For the stress calculation, we use a trilinear traction-separation law, given by (see [Figure M185-1](#) right):

$$t(\lambda) = \begin{cases} \sigma_{\max} \frac{\lambda}{\Lambda_1/\Lambda_{\text{fail}}} & \lambda < \Lambda_1/\Lambda_{\text{fail}} \\ \sigma_{\max} & \Lambda_1/\Lambda_{\text{fail}} < \lambda < \Lambda_2/\Lambda_{\text{fail}} \\ \sigma_{\max} \frac{1 - \lambda}{1 - \Lambda_2/\Lambda_{\text{fail}}} & \Lambda_2/\Lambda_{\text{fail}} < \lambda < 1 \end{cases}$$

With this law, the traction drops to zero when $\lambda = 1$. A potential, ϕ , is defined as:

$$\phi(\delta_1, \delta_2, \delta_3) = \text{NLS} \times \int_0^\lambda t(\bar{\lambda}) d\bar{\lambda}$$

Finally, the tangential components (t_1, t_2) and normal component (t_3) of the traction acting on the interface in the fracture process zone are given by:

$$t_{1,2} = \frac{\partial \phi}{\partial \delta_{1,2}} = \frac{t(\lambda)}{\lambda} \frac{\delta_{1,2}}{\text{TLS}} \frac{\text{NLS}}{\text{TLS}}, \quad t_3 = \frac{\partial \phi}{\partial \delta_3} = \frac{t(\lambda)}{\lambda} \frac{\delta_3}{\text{NLS}}$$

which in matrix notation is

$$\begin{bmatrix} t_1 \\ t_2 \\ t_3 \end{bmatrix} = \frac{t(\lambda)}{\lambda} \begin{bmatrix} \frac{\text{NLS}}{\text{TLS}^2} & 0 & 0 \\ 0 & \frac{\text{NLS}}{\text{TLS}^2} & 0 \\ 0 & 0 & \frac{1}{\text{NLS}} \end{bmatrix} \begin{bmatrix} \delta_1 \\ \delta_2 \\ \delta_3 \end{bmatrix}$$

In the case of compression ($\delta_3 < 0$), penetration is avoided by:

$$t_3 = \frac{\text{STFSF} \times \sigma_{\max}}{\text{NLS} \times \Lambda_1 / \Lambda_{\text{fail}}} \delta_3$$

Loading and unloading follows the same path, that is, this model is completely reversible.

Remarks:

1. **Traction output to d3plot.** This cohesive material model outputs three tractions having units of force per unit area to the d3plot database rather than the usual six stress components. The in-plane shear traction, t_1 , along the 1-2 edge replaces the x -stress, the orthogonal in-plane shear traction, t_2 , replaces the y -stress, and the traction in the normal direction, t_3 , replaces the z -stress.
2. **XFEM Shells.** For XFEM shells, TLS for δ_2 in the above equation is replaced by TLS2. Since the initially rigid cohesive law is used, an element fails only when the stress level reaches SIGMAX. Λ_1 is only used to define the penetration stiffness in case of a crack closing (compression).

***MAT_COHESIVE_GENERAL**

This is Material Type 186. It can be used only with cohesive element formulations; see the variable ELFORM in *SECTION_SOLID and *SECTION_SHELL. The material model allows you to choose from three general irreversible mixed-mode interaction cohesive formulations. It also includes an arbitrary normalized traction-separation law given by a load curve (TSLC). These three formulations are differentiated through the type of the effective separation parameter (TES). The interaction between fracture modes I and II is considered. Irreversible conditions are enforced with a damage formulation (unloading/reloading path pointing to/from the origin). See remarks for details.

Card 1	1	2	3	4	5	6	7	8
Variable	MID	RO	ROFLG	INTFAIL	TES	TSLC	GIC	GIIC
Type	A	F	F	F	F	F	F	F

Card 2	1	2	3	4	5	6	7	8
Variable	XMU	T	S	STFSF	TSLC2			
Type	F	F	F	F	F			

VARIABLE**DESCRIPTION**

MID	Material identification. A unique number or label must be specified (see *PART).
RO	Mass density
ROFLG	Flag for whether density is specified per unit area or volume: EQ.0: Specifies density per unit volume (default) EQ.1: Specifies the density is per unit area for controlling the mass of cohesive elements with an initial volume of zero
INTFAIL	Number of integration points required for a cohesive element to be deleted. The value of INTFAIL may range from 1 to 4 with 1 the recommended value.

VARIABLE	DESCRIPTION
	<p>LT.0.0: Employs a Newton-Cotes integration scheme. The element will be deleted when INTFAIL integration points have failed.</p> <p>EQ.0.0: Employs a Newton-Cotes integration scheme. The element will <i>not</i> be deleted even if it satisfies the failure criterion.</p> <p>GT.0.0: Employs a Gauss integration scheme. The element will be deleted when INTFAIL integration points have failed.</p>
TES	<p>Type of effective separation parameter (ESP).</p> <p>EQ.0.0: A dimensional separation measure is used. For the interaction between modes I and II, a mixed-mode propagation criterion is given by a power law. See Remarks 1 and 2.</p> <p>EQ.1.0: A dimensional separation measure is used. For the interaction between modes I and II, a mixed-mode propagation criterion is given by the Benzeggagh-Kenane law [1996]. See Remarks 1 and 2.</p> <p>EQ.2.0: A dimensionless separation measure is used for the interaction between mode I displacements and mode II displacements (similar to *MAT_185, but with damage and general traction-separation law). See Remarks 1 and 3.</p>
TSLC	<p>Normalized traction-separation load curve ID. The curve must be normalized in both coordinates and must contain at least three points: (0.0, 0.0), (λ_0, 1.0), and (1.0, 0.0). These points represent the origin, the peak, and the complete failure, respectively (see Figure M186-1). A platform can exist in the curve like the trilinear TSLC (see *MAT_185). See Remark 1.</p>
GIC	<p>Fracture toughness / energy release rate G_I^c for mode I</p>
GIIC	<p>Fracture toughness / energy release rate G_{II}^c for mode II</p>
XMU	<p>Exponent that appears in the power failure criterion (TES = 0.0) or the Benzeggagh-Kenane failure criterion (TES = 1.0). Recommended values for XMU are between 1.0 and 2.0. See Remark 2.</p>
T	<p>Peak traction in normal direction (mode I). See Remark 1.</p>

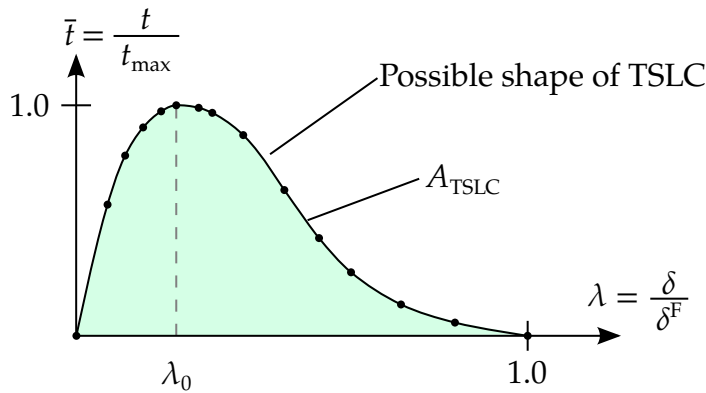

	Mode I	Mode II
t_{\max}	T	S
δ^F	$\frac{G_I^c}{A_{TSLC}T}$	$\frac{G_{II}^c}{A_{TSLC}S}$
G^c	G_I^c	G_{II}^c

Figure M186-1. Normalized traction-separation law

VARIABLE	DESCRIPTION
S	Peak traction in tangential direction (mode II). See Remark 1.
STFSF	Penetration stiffness multiplier for compression. Factor = (1.0 + STFSF) is used to scale the compressive stiffness, that is, no scaling is done with STFSF = 0.0 (recommended).
TSLC2	Normalized traction-separation load curve ID for Mode II. The curve must be normalized in both coordinates and must contain at least three points: (0.0,0.0), (λ_0 ,1.0), and (1.0,0.0), which represents the origin, the peak and the complete failure, respectively (see Figure M186-1). If not specified, TSLC is used for Mode II behavior as well. See Remark 1.

Remarks:

1. **Traction-Separation Behavior.** For all three formulations, the traction-separation behavior of this model is mainly given by G_I^c and T for normal mode I, G_{II}^c and S for tangential mode II, and an arbitrary normalized traction-separation load curve for both modes (see Figure M186-1). The maximum (or failure) separations are then given by:

$$\delta_I^F = \frac{G_I^c}{A_{TSLC} \times T} , \quad \delta_{II}^F = \frac{G_{II}^c}{A_{TSLC} \times S}$$

Here A_{TSLC} is the area under the normalized traction-separation curve given with TSLC.

If TSLC2 is defined,

$$\delta_I^F = \frac{G_I^c}{A_{TSLC2} \times T} , \quad \delta_{II}^F = \frac{G_{II}^c}{A_{TSLC2} \times S}$$

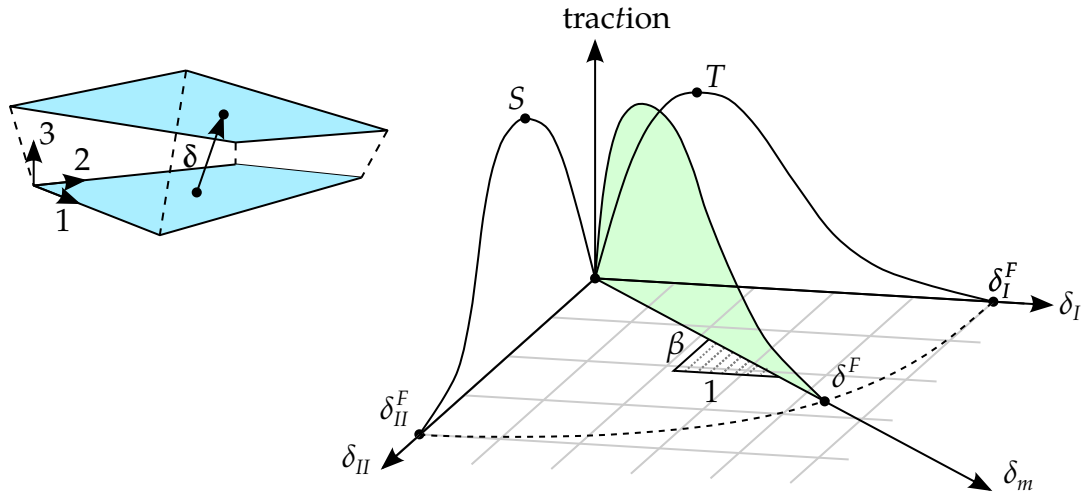

Figure M186-2. Mixed mode traction-separation law

Here A_{TSLC2} is the area under the normalized traction-separation curve given with TSLC2.

- 2. First and Second Mixed-Mode Interaction Cohesive Formulations (TES = 0.0 and 1.0).** For mixed-mode behavior, three different formulations are possible. We recommend TES = 0.0 with XMU = 1.0 as a first try. In this remark we will discuss the two formulations with dimensional separation measures.

The total mixed-mode relative displacement δ_m is defined as $\delta_m = \sqrt{\delta_I^2 + \delta_{II}^2}$, where $\delta_I = \delta_3$ is the separation in normal direction (mode I) and $\delta_{II} = \sqrt{\delta_1^2 + \delta_2^2}$ is the separation in tangential direction (mode II). See [Figure M186-2](#).

The ultimate mixed-mode displacement δ^F (total failure) for the power law (TES = 0.0) is

$$\delta^F = \frac{1 + \beta^2}{A_{TSLC}} \left[\left(\frac{T}{G_I^c} \right)^{XMU} + \left(\frac{S \times \beta^2}{G_{II}^c} \right)^{XMU} \right]^{-\frac{1}{XMU}}$$

If TSLC2 is defined, this changes to:

$$\delta^F = (1 + \beta^2) \left[\left(\frac{A_{TSLC} \times T}{G_I^c} \right)^{XMU} + \left(\frac{A_{TSLC2} \times S \times \beta^2}{G_{II}^c} \right)^{XMU} \right]^{-\frac{1}{XMU}}$$

Alternatively, for the Benzeggagh-Kenane law [1996] (TES = 1.0) δ^F is given by:

$$\delta^F = \frac{1 + \beta^2}{A_{TSLC}(T + S \times \beta^2)} \left[G_I^c + (G_{II}^c - G_I^c) \left(\frac{S \times \beta^2}{T + S \times \beta^2} \right)^{XMU} \right]$$

If TSLC2 is defined, this changes to:

$$\delta^F = \frac{1 + \beta^2}{A_{\text{TSLC}} \times T + A_{\text{TSLC2}} \times S \times \beta^2} \left[G_I^c + (G_{II}^c - G_I^c) \left(\frac{A_{\text{TSLC2}} \times S \times \beta^2}{A_{\text{TSLC}} \times T + A_{\text{TSLC2}} \times S \times \beta^2} \right)^{\text{XMU}} \right]$$

where $\beta = \delta_{II}/\delta_I$ is the “mode mixity”. The larger the chosen exponent, XMU, is, the larger the fracture toughness will be in mixed-mode situations.

In this model, damage of the interface is considered, that is, irreversible conditions are enforced with loading/unloading paths coming from/pointing to the origin. This formulation is similar to *MAT_COHESIVE_MIXED_MODE (*MAT_138), but with the arbitrary traction-separation law TSLC.

- 3. Third Mixed-Mode Interaction Cohesive Formulations (TES = 2.0).** For TES = 2.0, we use a dimensionless effective separation parameter λ to model the interaction between relative displacements in normal (δ_3 - mode I) and tangential (δ_1, δ_2 - mode II) directions:

$$\lambda = \sqrt{\left\langle \frac{\delta_1}{\delta_{II}^F} \right\rangle^2 + \left\langle \frac{\delta_2}{\delta_{II}^F} \right\rangle^2 + \left\langle \frac{\delta_3}{\delta_I^F} \right\rangle^2}$$

Macaulay brackets distinguish between tension ($\delta_3 \geq 0$) and compression ($\delta_3 < 0$). δ_I^F and δ_{II}^F are critical values, representing the maximum separations in the interface in normal and tangential direction. For the stress calculation, the normalized traction-separation load curve TSLC is used:

$$t = t_{\text{max}} \times \bar{f}(\lambda)$$

This formulation is similar to *MAT_COHESIVE_TH (*MAT_185) but with an arbitrary traction-separation law and a damage formulation (that is, irreversible conditions are enforced with loading/unloading paths coming from/pointing to the origin).

*MAT_SAMP-1

Purpose: This is Material Type 187 (Semi-Analytical Model for Polymers). This material model uses an isotropic C-1 smooth yield surface for the description of non-reinforced plastics. Details of the implementation are given in [Kolling, Haufe, Feucht and Du Bois 2005].

This material law has been developed at DaimlerChrysler, Sindelfingen, in collaboration with Paul Du Bois and Dynamore, Stuttgart.

Card Summary:

Card 1. This card is required.

MID	RO	BULK	GMOD	EMOD	NUE	RBCFAC	NUMINT
-----	----	------	------	------	-----	--------	--------

Card 2. This card is required.

LCID-T	LCID-C	LCID-S	LCID-B	NUEP	LCID-P		INCDAM
--------	--------	--------	--------	------	--------	--	--------

Card 3. This card is required.

LCID-D	EPFAIL	DEPRPT	LCID_TRI	LCID_LC			
--------	--------	--------	----------	---------	--	--	--

Card 4. This card is required.

MITER	MIPS		INCFAIL	ICONV	ASAF		NHSV
-------	------	--	---------	-------	------	--	------

Card 5. This card is optional.

LCEMOD	BETA	FILT					
--------	------	------	--	--	--	--	--

Data Card Definitions:

Card 1	1	2	3	4	5	6	7	8
Variable	MID	RO	BULK	GMOD	EMOD	NUE	RBCFAC	NUMINT
Type	A	F	F	F	F	F	F	I/F

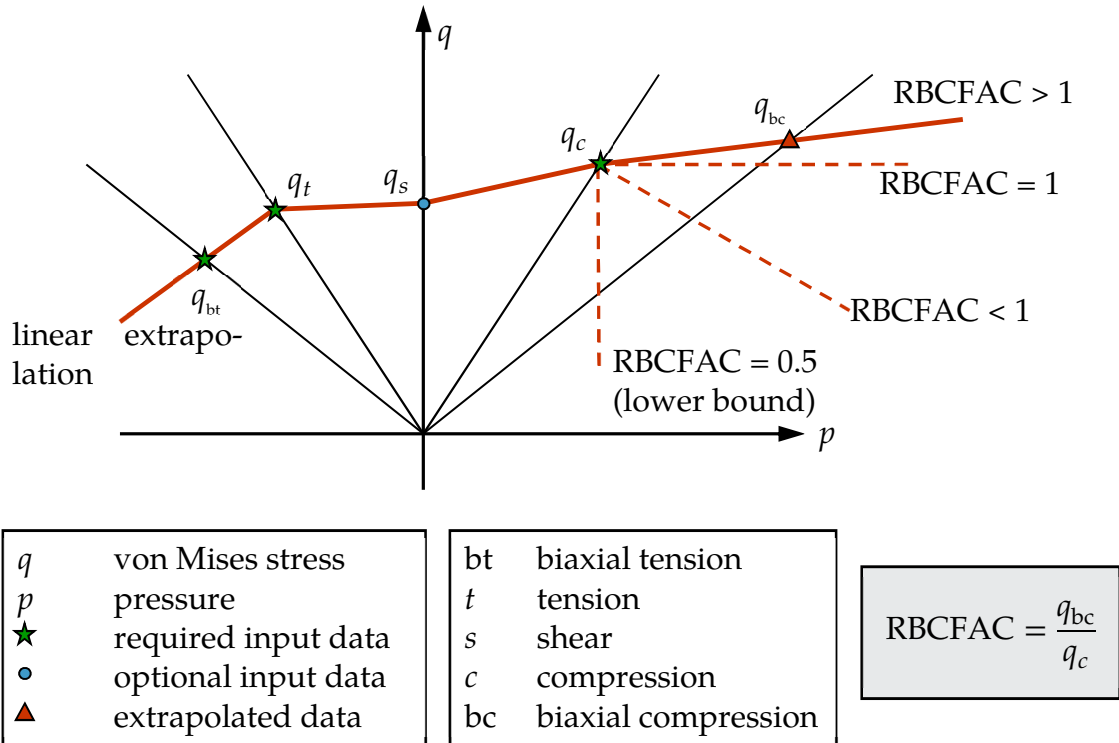

Figure M187-1. von Mises stress as a function of pressure

VARIABLE	DESCRIPTION
MID	Material identification. A unique number or label must be specified (see *PART).
RO	Mass density
BULK	Optional bulk modulus used in the time step calculation for solids only
GMOD	Optional shear modulus used in the time step calculation for solids only
EMOD	Young's modulus
NUE	Poisson ratio
RBCFAC	Ratio of yield in biaxial compression as a function of yield in uniaxial compression. If RBCFAC is nonzero and all four curves LCID-T, LCID-C, LCID-S, and LCID-B are defined, a piecewise-linear yield surface as shown in Figure M187-1 is activated. See Remark 3. Default is 0.

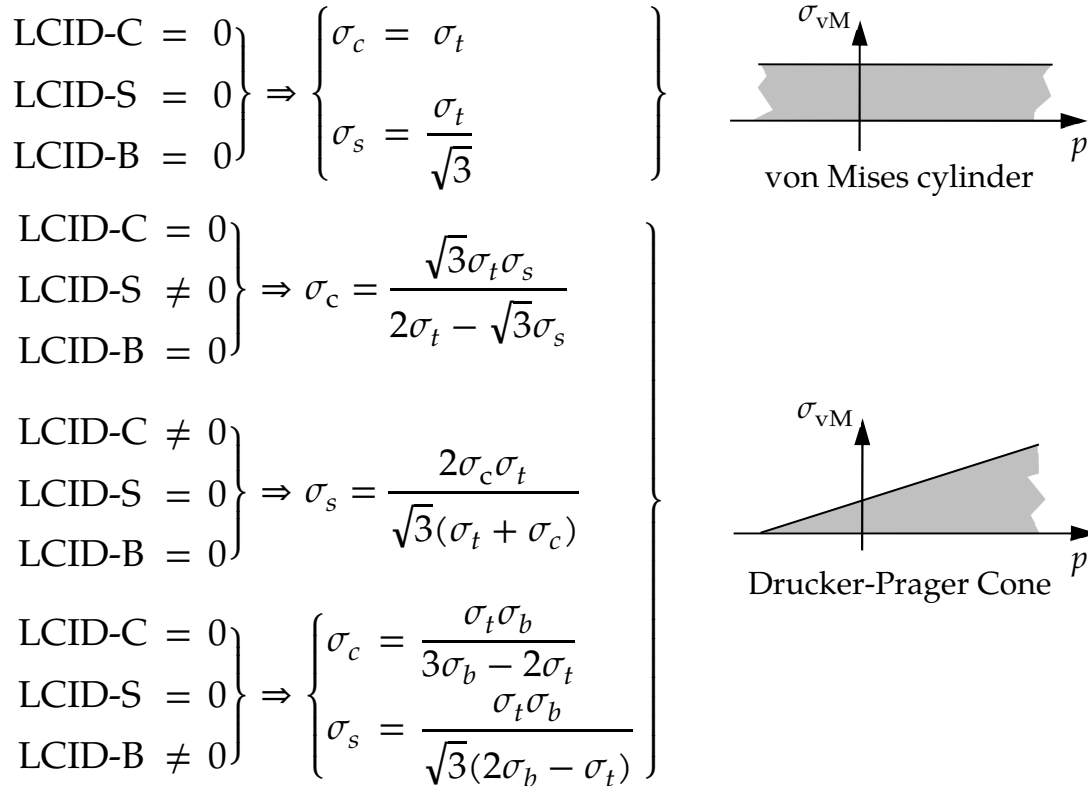

Figure M187-2. Fewer than 3 load curves

VARIABLE

DESCRIPTION

NUMINT

Number of integration points which must fail before the element is deleted. This option is available for shells and solids.

LT.0.0: |NUMINT| is the percentage of integration points/layers which must fail before the shell element fails. For fully integrated shells, a layer fails if one integration point in the layer fails, and then the element fails if the given percentage of layers fails. Only available for shells.

Card 2	1	2	3	4	5	6	7	8
Variable	LCID-T	LCID-C	LCID-S	LCID-B	NUEP	LCID-P		INCDAM
Type	I	I	I	I	F	I		I

VARIABLE	DESCRIPTION
LCID-T	Load curve or table ID giving the yield stress as a function of plastic strain. These curves should be obtained from quasi-static and (optionally) dynamic uniaxial tensile tests. This input is mandatory, and the material model will not work unless at least one tensile stress-strain curve is given. If LCID-T is a table ID, the table values are plastic strain rates, and a curve of yield stress versus plastic strain must be given for each of those strain rates. If the first value in the table is negative, LS-DYNA assumes that all the table values represent the natural logarithm of plastic strain rate. When the highest plastic strain rate is several orders of magnitude greater than the lowest strain rate, it is recommended that the natural log of plastic strain rate be input in the table. See Remark 4 .
LCID-C	Optional load curve ID giving the yield stress as a function of plastic strain. This curve should be obtained from a quasi-static uniaxial compression test.
LCID-S	Optional load curve ID giving the yield stress as a function of plastic strain. This curve should be obtained from a quasi-static shear test.
LCID-B	Optional load curve ID giving the yield stress as a function of plastic strain, this curve should be obtained from a quasi-static biaxial tensile test.
NUEP	Plastic Poisson's ratio: an estimated ratio of transversal to longitudinal plastic rate of deformation under uniaxial loading should be given.
LCID-P	Load curve ID giving the plastic Poisson's ratio as a function of plastic strain during uniaxial tensile and uniaxial compressive testing. The plastic strain on the abscissa is negative for compression and positive for tension. It is important to cover both tension and compression. If LCID-P is given, NUEP is ignored.
INCDAM	Flag to control the damage evolution as a function of triaxiality: EQ.0: Damage evolution is independent of the triaxiality. EQ.1: An incremental formulation is used to compute the damage.

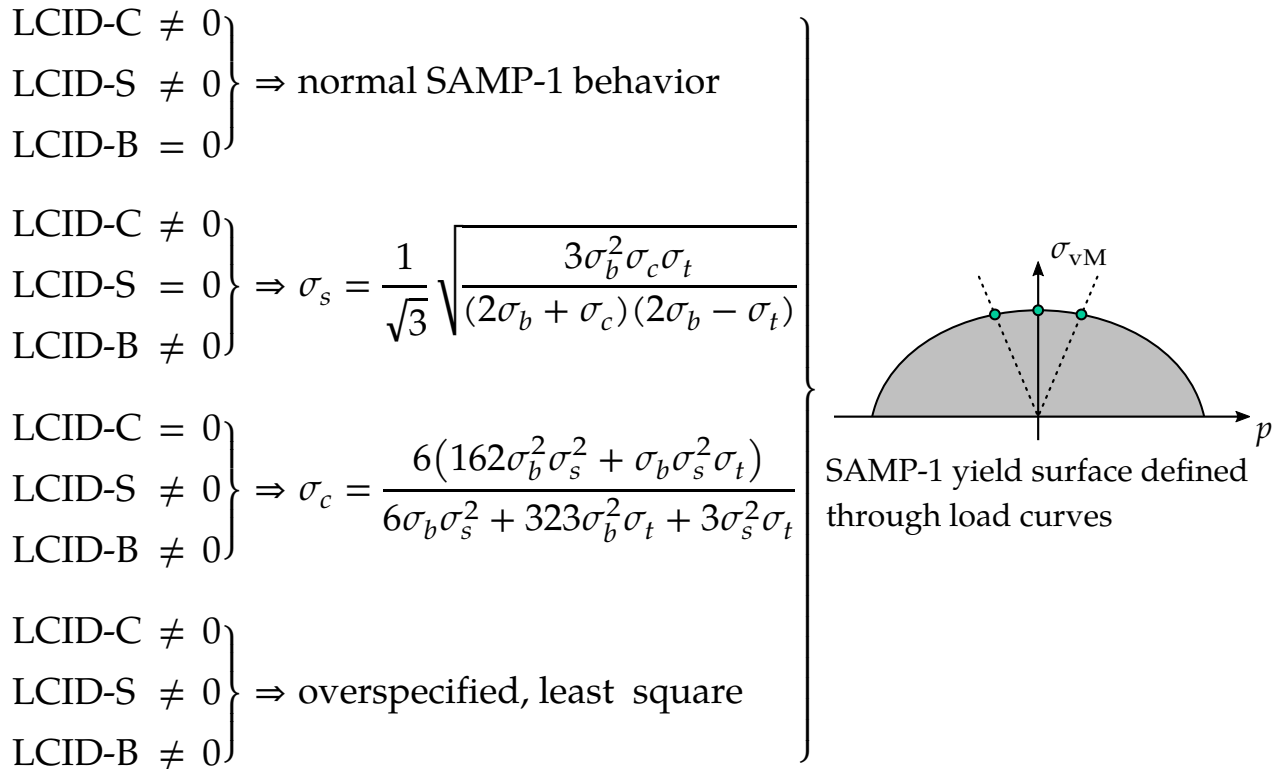

Figure M187-3. Three or more load curves

Card 3	1	2	3	4	5	6	7	8
Variable	LCID-D	EPFAIL	DEPRPT	LCID_TRI	LCID_LC			
Type	I	F	F	I	I			

VARIABLE

DESCRIPTION

LCID-D

Load curve ID giving the damage parameter as a function of equivalent plastic strain during uniaxial tensile testing (history variable #2). By default, this option assumes that effective (i.e. undamaged) yield values are used in the load curves LCID-T, LCID-C, LCID-S and LCID-B. If LCID-D is given a negative value, true (meaning damaged) yield stress values can be used. In this case an automatic stress-strain recalibration (ASSR) algorithm is activated. The damage value must be defined in the range $0 \leq d < 1$. If EPFAIL and DEPRPT are given, the curve is used only until the effective plastic strain reaches EPFAIL.

VARIABLE	DESCRIPTION
EPFAIL	This parameter is the equivalent plastic strain at failure under uniaxial tensile loading (history variable #2). If EPFAIL is given as a negative integer, a load curve is expected that defines EPFAIL as a function of the plastic strain rate. Default value is 10^5 .
DEPRPT	Increment of equivalent plastic strain under uniaxial tensile loading (history variable #2) between failure point and rupture point. Stresses will fade out to zero between EPFAIL and EPFAIL + DEPRPT. If DEPRPT is given a negative value, a curve definition is expected where DEPRPT is defined as function of the triaxiality.
LCID_TRI	Load curve that specifies a factor that works multiplicatively on the value of EPFAIL depending on the triaxiality (that is, p/σ_{VM}). For a triaxiality of $-1/3$ a value of 1.0 should be specified.
LCID_LC	Load curve that specifies a factor that works multiplicatively on the value of EPFAIL depending on a characteristic element length, defined as the average length of spatial diagonals

Card 4	1	2	3	4	5	6	7	8
Variable	MITER	MIPS		INCFAIL	ICONV	ASAF		NHSV
Type	I	I		I	I	F		I

VARIABLE	DESCRIPTION
MITER	Maximum number of iterations in the cutting plane algorithm. The default is 400.
MIPS	Maximum number of iterations in the secant iteration performed to enforce plane stress (shell elements only). The default is 10.
INCFAIL	Flag to control the failure evolution as a function of triaxiality: EQ.0: Failure evolution is independent of the triaxiality. EQ.1: Incremental formulation is used to compute the failure value. EQ.-1: The failure model is deactivated.

VARIABLE	DESCRIPTION
ICONV	Formulation flag: EQ.0: Default EQ.1: Yield surface is internally modified by increasing the shear yield until a convex yield surface is achieved.
ASAF	Safety factor used only if ICONV = 1. Values between 1 and 2 can improve convergence, however the shear yield will be artificially increased if this option is used. The default is 1.
NHSV	Number of history variables. Default is 22. Set to 28 if the “instability criterion” should be included in the output (see Remark 5). Note that NEIPS or NEIPH must also be set on *DATABASE_EXTENT_BINARY for the history variable data to be output.

Optional Card.

Card 5	1	2	3	4	5	6	7	8
Variable	LCEMOD	BETA	FILT					
Type	F	F	F					

VARIABLE	DESCRIPTION
LCEMOD	Load curve ID defining Young’s modulus as function of effective strain rate
BETA	Decay constant in viscoelastic law: $\dot{\sigma}(t) = -\beta \times \sigma(t) + E(\dot{\epsilon}(t)) \times \dot{\epsilon}(t)$ If LCEMOD > 0 is used, a non-zero value for BETA is mandatory.
FILT	Factor for strain rate filtering: $\dot{\epsilon}_{n+1}^{avg} = (1 - \text{FILT}) \times \dot{\epsilon}_{n+1}^{cur} + \text{FILT} \times \dot{\epsilon}_n^{avg}$

Load Curves:

Material SAMP-1 uses three yield curves internally to evaluate a quadratic yield surface. *MAT_SAMP-1 accepts four different kinds of yield curves, LCID-T, LCID-C, LCID-S, and LCID-B where data from tension tests (LCID-T) is always required, but the others are

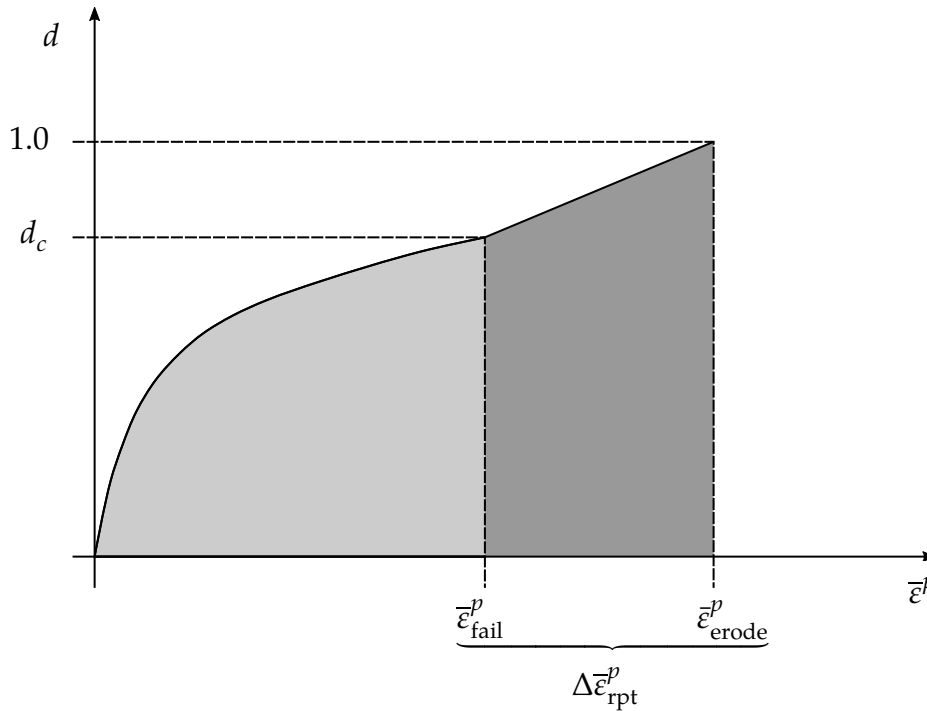

Figure M187-4. EPFAIL and DEPRPT defined the failure and fading behavior of a single element.

optional. If fewer than three curves are defined, as indicated by setting the missing load curve IDs to 0, the remaining curves are generated internally.

1. **Fewer than 3 load curves.** In the case of fewer than 3 load curves, a linear yield surface in the invariant space spanned by the pressure and the von Mises stress is generated using the available data. See [Figure M187-2](#).
2. **Three or more load curves.** See [Figure M187-3](#).

Remarks:

1. **Damage.** If the LCID-D is given, then a damage curve as a function of equivalent plastic strains acting on the stresses is defined as shown in [Figure M187-4](#).

Since the damaging curve acts on the yield values, the inelastic results are affected by the damage curve. As a means to circumvent this, the load curve LCID-D may be given a negative ID. This will lead to an internal conversion of from nominal to effective stresses (ASSR). While this conversion is possible for some combinations of yield curve definitions, plastic Poisson's ratio and damage curves, the corresponding inverse problem cannot be solved for all combinations. An error message is provided in this case.

2. **Unsolvable Yield Surface Case.** Since the generality of arbitrary curve inputs allows unsolvable yield surfaces, SAMP may modify curves internally. This will always lead to warning messages at the beginning of the simulation run. One modification that is not allowed are negative tangents of the last two data points of any of the yield curves.
3. **RBCFAC.** If RBCFAC is nonzero and curves LCID-T, LCID-C, LCID-S, and LCID-B are specified, the yield surface in I_1 - σ_{vm} -stress space is constructed such that a piecewise-linear yield surface is activated. This option can help promote convergence of the plasticity algorithm. [Figure M187-1](#) illustrates the effect of RBCFAC on behavior in biaxial compression.
4. **Dynamic Amplification Factor for Yield Stress.** If LCID-T is given as a table specifying strain-rate scaling of the yield stress, then the compressive, shear and biaxial yield stresses are computed by multiplying their respective static values by dynamic amplification factor (dynamic/static ratio) of the tensile yield stress.
5. **Instability Criterion.** Instability at an integration point is a value between 0 and 1 indicating the integration point's proximity to damage start. If instability reaches 1, then damage starts and grows from 0 to 1. The element then "ruptures". The choice of INCFAIL determines how instability is calculated. For INCFAIL = 0,

$$\text{instability} = (\text{equivalent plastic strain})/\text{EPFAIL}$$
6. **History Variables.** This material has the following history variables. NEIPH or NEIPS on *DATABASE_EXTENT_BINARY must be set for the history data to be output.

#	Interpretation
2	Plastic strain in tension/compression
3	Plastic strain in shear
4	Biaxial plastic strain
5	Damage
6	Volumetric plastic strain
16	Plastic strain rate in tension/compression
17	Plastic strain rate in shear
18	Biaxial plastic strain rate

#	Interpretation
28	Instability criterion (set NHSV = 28, see Remark 5)

*MAT_SAMP_LIGHT

Purpose: This is a slimmed-down form of Material Type 187. In contrast to the original SAMP-1 the options here are limited to rate independent or rate dependent flow in tension and compression as well as constant or variable plastic Poisson’s ratio. Shear and biaxial test data are not incorporated. Damage and failure are not available here. *MAT_ADD_EROSION or *MAT_ADD_DAMAGE can be included for damage and failure. But as in the original model, a viscoelastic extension can be activated.

This model is based on a complete re-coding of the plasticity algorithm. The efficiency was improved to the extent that the computing times should be shorter. As compared to *MAT_SAMP-1, results should differ only slightly. The main difference is the formulation for rate effects: the viscoplastic formulation (“VP = 1”) for *MAT_SAMP-1 and the yield stress scaled using total strain rate (“VP = 0”) for *MAT_SAMP_LIGHT.

Card Summary:

Card 1. This card is required.

MID	RO			EMOD	NUE	LCEMOD	BETA
-----	----	--	--	------	-----	--------	------

Card 2. This card is required.

LCID-T	LCID-C	CTFLG	RATEOP	NUEP	LCID-P	RFILTF	
--------	--------	-------	--------	------	--------	--------	--

Data Card Definitions:

Card 1	1	2	3	4	5	6	7	8
Variable	MID	RO			EMOD	NUE	LCEMOD	BETA
Type	A	F			F	F	I	F

VARIABLE

DESCRIPTION

MID	Material identification. A unique number or label must be specified (see*PART).
RO	Mass density
EMOD	Young’s modulus
NUE	Poisson ratio

VARIABLE**DESCRIPTION**

LCEMOD Load curve ID defining Young's modulus as function of effective strain rate. LCEMOD \neq 0 activates viscoelasticity (see [Remark 3](#)). The parameters BETA and RFILTF must be defined too.

BETA Decay constant in viscoelastic law (see [Remark 3](#)). BETA has the unit [1/time]. If LCEMOD > 0 is used, a nonzero value for BETA is mandatory.

Card 2	1	2	3	4	5	6	7	8
Variable	LCID-T	LCID-C	CTFLG	RATEOP	NUEP	LCID-P	RFILTF	
Type	I	I	F	I	F	I	F	
Default	none	0	0	0	none	0	0.95	

VARIABLE**DESCRIPTION**

LCID-T Load curve or table ID giving the yield stress as a function of plastic strain. These curves should be obtained from quasi-static and (optionally) dynamic uniaxial tensile tests. This input is mandatory. If LCID-T is a table ID, the table values are effective strain rates, and a curve of yield stress as a function of plastic strain must be given for each of those strain rates. If the first value in the table is negative, LS-DYNA assumes that all the table values represent the natural logarithm of effective strain rate. When the highest effective strain rate is several orders of magnitude greater than the lowest strain rate, it is recommended that the natural log of strain rate be input in the table. See [Remark 1](#).

LCID-C Optional load curve (or table) ID giving the yield stress as a function of plastic strain (and strain rate). This curve (or table) should be obtained from uniaxial compression tests. If LCID-C is defined as a curve and LCID-T given as a table, then the rate dependence from the tension table is adopted in compression as well. See [Remark 1](#).

CTFLG Curve treatment flag (for LCID-T, LCID-C, and LCID-P)

VARIABLE	DESCRIPTION
	EQ.0: Rediscretized curves are used (default). We recommend using this option together with an appropriate value of LCINT for accurate resolution of the curves (see *DEFINE_CURVE and *CONTROL_SOLUTION).
	EQ.1: Original curve values from the input are used.
RATEOP	Calculation of effective strain rate option: EQ.0: Original method for calculating the effective strain rate EQ.2: Improved method for calculating the effective strain rate. This method gives a slightly closer match to *MAT_SAMP-1 and is thus recommended.
NUEP	Plastic Poisson's ratio: an estimated ratio of transversal to longitudinal plastic rate of deformation under uniaxial loading should be given. Ignored if LCID-P is nonzero. See Remark 1 .
LCID-P	Load curve ID giving the plastic Poisson's ratio as a function of an equivalent plastic strain measure during uniaxial tensile and uniaxial compressive testing. The plastic strain measure on the abscissa is negative for compression and positive for tension. It is important to cover both tension and compression. If LCID-P is given, NU EP is ignored. See Remark 1 .
RFILTF	Smoothing factor on the effective strain rate (default is 0.95). The filtered strain rate is used for the rate dependent plastic flow (LCID-T being a table) as well as for the viscoelasticity (LCEMOD > 0). See Remark 2 .

$$\dot{\epsilon}_n^{\text{avg}} = \text{RFILTF} \times \dot{\epsilon}_{n-1}^{\text{avg}} + (1 - \text{RFILTF}) \times \dot{\epsilon}_n$$

Remarks:

- Yield surfaces.** In the case of one tensile load curve (or table) LCID-T, the yield surface is von Mises type with associated (NU EP = 0.5) or non-associated (else) plastic flow. In the case LCID-T and LCID-C are both defined, a Drucker-Prager type yield surface is used. The plastic flow direction again depends on the choice of NU EP/LCID-P.

The yield condition is given by

$$F = \sigma^{\text{eff}} - \sigma^{Y,T} \leq 0$$

with the effective stress

$$\sigma^{eff} = (1 - \zeta) \times \sigma^{vM} - 3\zeta \times p$$

based on the von Mises stress σ^{vM} , the pressure p and the Drucker-Prager slope parameter

$$\zeta = \frac{\sigma^{Y,C} - \sigma^{Y,T}}{2 \times \sigma^{Y,C}}$$

defined by the tensile and compressive yield stresses $\sigma^{Y,T}$ and $\sigma^{Y,C}$ (input with LCID-T and optionally LCID-C). The plastic potential

$$G = \sqrt{(\sigma^{vM^2} + \alpha \times p^2)}$$

with

$$\alpha = \frac{9}{2} \left(\frac{1 - 2\nu^p}{1 + \nu^p} \right)$$

and the plastic Poisson’s ratio ν^p defines the direction of plastic flow. ν^p can be input as a constant with NUPE or as a function of equivalent plastic strain with LCID-P. The elasto-plastic equations are solved with a classical predictor-corrector algorithm for the plastic strain increment $\Delta\epsilon^p$ and stress σ^{n+1} .

2. **Effective strain rate.** If tables are used for hardening, the rate dependence is defined by using an effective strain rate. To reduce the noise from the elastic portion of that strain rate, an averaged value is used. This is governed by the filtering parameter RFILTF as shown above.
3. **Nonlinear viscoelasticity.** For LCEMOD $\neq 0$, viscoelasticity is activated. With this model, EMOD becomes the Young’s modulus for equilibrium stress (E_{eq}). LCEMOD specifies the viscous Young’s modulus which is a function of averaged strain rate ($E_v(\dot{\epsilon}^{avg})$). BETA gives a constant decay parameter specifying the ratio $\frac{E_v(\dot{\epsilon}^{avg})}{\eta(\dot{\epsilon}^{avg})}$ where η is the viscosity. The viscoelastic stress-strain law is given by:

$$\dot{\sigma}_v = -BETA \times \sigma(t) + E_v(\dot{\epsilon}^{avg}) \times \dot{\epsilon}^{avg}$$

The one-dimensional viscoelastic behavior can be visualized by a generalized Maxwell cell as rheological model as shown in [Figure M187-1](#).

We will be using the notation of the viscoelastic-plastic stress update. For simplicity we will discuss the one-dimensional case. Let $\Delta\epsilon^{vp}$ be the viscoplastic strain increment and let σ_{eq} and σ_v be the equilibrium and viscous stress portions. The stress update is then:

$$\sigma^{n+1} = \sigma_{eq}^{n+1} + \sigma_v^{n+1}$$

or with stress increments:

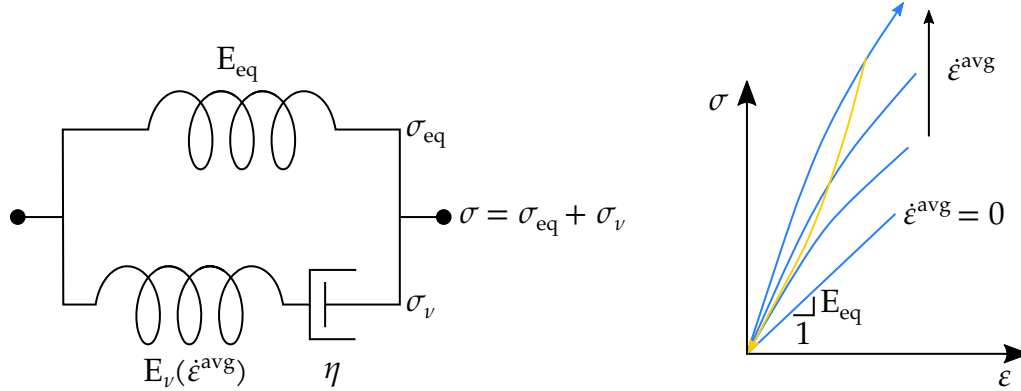

Figure M187-1. Viscoelastic model and strain rate dependent stress-strain curves.

$$\sigma^{n+1} = \sigma^n + \Delta\sigma_{eq} + \Delta\sigma_v.$$

In the elastic trial-step the equilibrium and viscous stress increments $\Delta\sigma_{eq}^{tr}$ and $\Delta\sigma_v^{tr}$ are calculated as:

$$\Delta\sigma_{eq}^{tr} = E_{eq} \times \Delta\epsilon$$

and

$$\Delta\sigma_v^{tr} = E_v(\dot{\epsilon}^{avg}) \frac{1 - e^{-\beta\Delta t}}{\beta\Delta t} (\dot{\epsilon}^{avg} \Delta t) - (1 - e^{-\beta\Delta t})\sigma_v^n$$

And the yield condition (see [Remark 1](#)) is evaluated:

$$F(\sigma^{n+1, tr}) = F(\sigma^n + \Delta\sigma_{eq}^{tr} + \Delta\sigma_v^{tr}).$$

For $F \leq 0$ the trial stress state is the current stress, that is, $\sigma^{n+1} = \sigma^n + \Delta\sigma_{eq}^{tr} + \Delta\sigma_v^{tr}$. Otherwise, the plastic strain increment $\Delta\epsilon^p$ must be evaluated and the equilibrium and viscous stress increments are updated.

For $F(\sigma_{eq}^{tr}) > 0$:

$$\begin{aligned}\sigma_{eq}^{n+1} &= \sigma_{eq}^{tr} - E_{eq}\Delta\epsilon^p \\ \sigma_v^{n+1} &= \sigma_v^{tr} - E_v(\dot{\epsilon}^{avg}) \frac{1 - e^{-\beta\Delta t}}{\beta\Delta t} \Delta\epsilon^p\end{aligned}$$

For $F(\sigma_{eq}^{tr}) \leq 0$:

$$\sigma_{eq}^{n+1} = \sigma_{eq}^{tr}$$

4. **History Variables.** This material has the following extra history variables:

History Variable #	Description
1	Filtered deviatoric strain rate for viscoelasticity (LCEMOD > 0)
2	Volumetric plastic strain
3	Number of iterations
4	Current yield stress
5	Filtered total strain rate
7	Deviatoric plastic strain

*MAT_THERMO_ELASTO_VISCOPLASTIC_CREEP

This is Material Type 188. In this model, creep is described separately from plasticity using Garafalo’s steady-state hyperbolic sine creep law or Norton’s power law. Viscous effects of plastic strain rate are considered using the Cowper-Symonds model. Young’s modulus, Poisson’s ratio, thermal expansion coefficient, yield stress, material parameters of Cowper-Symonds model as well as the isotropic and kinematic hardening parameters are all assumed to be temperature dependent. Application scope includes: simulation of solder joints in electronic packaging, modeling of tube brazing process, creep age forming, etc.

Card Summary:

Card 1. This card is required.

MID	RO	E	PR	SIGY	ALPHA	LCSS	REFTEM
-----	----	---	----	------	-------	------	--------

Card 2. This card is required.

QR1	CR1	QR2	CR2	QX1	CX1	QX2	CX2
-----	-----	-----	-----	-----	-----	-----	-----

Card 3. This card is required.

C	P	LCE	LCPR	LCSIGY	LCQR	LCQX	LCALPH
---	---	-----	------	--------	------	------	--------

Card 4. This card is required.

LCC	LCP	LCCR	LCCX	CRPA	CRPB	CRPQ	CRPM
-----	-----	------	------	------	------	------	------

Card 5. This card is optional.

CRPLAW							
--------	--	--	--	--	--	--	--

Data Card Definitions:

Card 1	1	2	3	4	5	6	7	8
Variable	MID	RO	E	PR	SIGY	ALPHA	LCSS	REFTEM
Type	A8	F	F	F	F	F	F	F

VARIABLE	DESCRIPTION
MID	Material identification. A unique number or label not exceeding 8 characters must be specified.
RO	Mass density
E	Young's modulus
PR	Poisson's ratio
SIGY	Initial yield stress
ALPHA	Thermal expansion coefficient
LCSS	Load curve ID or Table ID. The load curve defines effective stress as a function of effective plastic strain. The table defines for each temperature value a load curve ID referencing stress as a function of effective plastic strain for that temperature. The stress as a function of effective plastic strain curve for the lowest value of temperature is used if the temperature falls below the minimum value. Likewise, the stress as a function of effective plastic strain curve for the highest value of temperature is used if the temperature exceeds the maximum value. Card 2 is ignored with this option.
REFTEM	Reference temperature that defines thermal expansion coefficient

Card 2	1	2	3	4	5	6	7	8
Variable	QR1	CR1	QR2	CR2	QX1	CX1	QX2	CX2
Type	F	F	F	F	F	F	F	F

VARIABLE	DESCRIPTION
QR1	Isotropic hardening parameter Q_{r1}
CR1	Isotropic hardening parameter C_{r1}
QR2	Isotropic hardening parameter Q_{r2}
CR2	Isotropic hardening parameter C_{r2}
QX1	Kinematic hardening parameter $Q_{\chi1}$

VARIABLE	DESCRIPTION
CX1	Kinematic hardening parameter $C_{\chi 1}$
QX2	Kinematic hardening parameter $Q_{\chi 2}$
CX2	Kinematic hardening parameter $C_{\chi 2}$

Card 3	1	2	3	4	5	6	7	8
Variable	C	P	LCE	LCPR	LCSIGY	LCQR	LCQX	LCALPH
Type	F	F	F	F	F	F	F	F

VARIABLE	DESCRIPTION
C	Viscous material parameter C
P	Viscous material parameter P
LCE	Load curve for scaling Young's modulus as a function of temperature
LCPR	Load curve for scaling Poisson's ratio as a function of temperature
LCSIGY	Load curve for scaling initial yield stress as a function of temperature
LCQR	Load curve for scaling the isotropic hardening parameters QR1 and QR2 or the stress given by the load curve LCSS as a function of temperature
LCQX	Load curve for scaling the kinematic hardening parameters QX1 and QX2 as a function of temperature
LCALPH	Load curve for scaling the thermal expansion coefficient as a function of temperature

Card 4	1	2	3	4	5	6	7	8
Variable	LCC	LCP	LCCR	LCCX	CRPA	CRPB	CRPQ	CRPM
Type	F	F	F	F	F	F	F	F

VARIABLE	DESCRIPTION
LCC	Load curve for scaling the viscous material parameter C as a function of temperature
LCP	Load curve for scaling the viscous material parameter P as a function of temperature
LCCR	Load curve for scaling the isotropic hardening parameters CR1 and CR2 as a function of temperature
LCCX	Load curve for scaling the kinematic hardening parameters CX1 and CX2 as a function of temperature
CRPA	Creep law parameter A GT.0.0: constant value LT.0.0: load curve ID = (-CRPA) which defines A as a function of temperature, $A(T)$
CRPB	Creep law parameter B GT.0.0: constant value LT.0.0: load curve ID = (-CRPB) which defines B as a function of temperature, $B(T)$
CRPQ	Creep law parameter $Q = E/R$ where E is the activation energy and R is the universal gas constant. GT.0.0: constant value LT.0.0: load curve ID = (-CRPQ) which defines Q as a function of temperature, $Q(T)$
CRPM	Creep law parameter m GT.0.0: constant value LT.0.0: load curve ID = (-CRPM) which defines m as a function of temperature, $m(T)$

Optional card 5

Card 5	1	2	3	4	5	6	7	8
Variable	CRPLAW							
Type	F							

VARIABLE**DESCRIPTION**

CRPLAW

Creep law definition (see Remarks):

EQ.0.0: Garofalo's hyperbolic sine law (default)

EQ.1.0: Norton's power law

Remarks:

If LCSS is not defined, the uniaxial stress-strain curve has the form

$$\sigma(\varepsilon_{\text{eff}}^p) = \sigma_0 + Q_{r1}[1 - \exp(-C_{r1}\varepsilon_{\text{eff}}^p)] + Q_{r2}[1 - \exp(-C_{r2}\varepsilon_{\text{eff}}^p)] \\ + Q_{\chi1}[1 - \exp(-C_{\chi1}\varepsilon_{\text{eff}}^p)] + Q_{\chi2}[1 - \exp(-C_{\chi2}\varepsilon_{\text{eff}}^p)].$$

Viscous effects are accounted for using the Cowper-Symonds model, which scales the yield stress with the factor:

$$1 + \left(\frac{\dot{\varepsilon}_{\text{eff}}^p}{C}\right)^{1/p}.$$

For CRPLAW = 0, the steady-state creep strain rate of Garafalo's hyperbolic sine equation is given by

$$\dot{\varepsilon}^c = A[\sinh(B\tau^e)]^m \exp\left(-\frac{Q}{T}\right).$$

For CRPLAW = 1, the steady-state creep strain rate is given by Norton's power law equation:

$$\dot{\varepsilon}^c = A(\tau^e)^B t^m.$$

In the above, τ^e is the effective elastic stress in the von Mises sense, T is the temperature and t is the time. The following is a schematic overview of the resulting stress update. The multiaxial creep strain increment is given by

$$\Delta\varepsilon^c = \Delta\varepsilon^c \frac{3\tau^e}{2\tau^e},$$

where τ^e is the elastic deviatoric stress tensor. Similarly, the plastic and thermal strain increments are given by

$$\Delta \epsilon^p = \Delta \epsilon^p \frac{3\tau^e}{2\tau^e}$$

$$\Delta \epsilon^T = \alpha_{t+\Delta t}(T - T_{\text{ref}})\mathbf{I} - \epsilon_t^T$$

where α is the thermal expansion coefficient (note the definition compared to that of other materials). Adding it all together, the stress update is given by

$$\sigma_{t+\Delta t} = \mathbf{C}_{t+\Delta t}(\epsilon_t^e + \Delta \epsilon - \Delta \epsilon^p - \Delta \epsilon^c - \Delta \epsilon^T) .$$

The plasticity is isotropic or kinematic but with a von Mises yield criterion, the subscript in the equation above indicates the simulation time of evaluation. Internally, this stress update requires the solution of a nonlinear equation in the effective stress, the viscoelastic strain increment and potentially the plastic strain increment.

*DEFINE_MATERIAL_HISTORIES can be used to output the viscoelastic (creep strain).

<i>*DEFINE_MATERIAL_HISTORIES Properties</i>					
Label	Attributes				Description
Effective Creep Strain	-	-	-	-	Viscoelastic strain ϵ^c , see above
Plastic Strain Rate	-	-	-	-	Effective plastic strain rate $\dot{\epsilon}_{\text{eff}}^p$

***MAT_ANISOTROPIC_THERMOELASTIC**

This is Material Type 189. This model characterizes elastic materials whose elastic properties are temperature-dependent.

It is available for solid elements, thick shell formulations 3, 5, and 7, and multi-material ALE solid elements. Note that it is not validated for multi-material ALE solid elements.

Card 1	1	2	3	4	5	6	7	8
Variable	MID	RO	TA1	TA2	TA3	TA4	TA5	TA6
Type	A	F	F	F	F	F	F	F

Card 2	1	2	3	4	5	6	7	8
Variable	C11	C12	C13	C14	C15	C16	C22	C23
Type	F	F	F	F	F	F	F	F

Card 3	1	2	3	4	5	6	7	8
Variable	C24	C25	C26	C33	C34	C35	C36	C44
Type	F	F	F	F	F	F	F	F

Card 4	1	2	3	4	5	6	7	8
Variable	C45	C46	C55	C56	C66	TGE	TREF	AOPT
Type	F	F	F	F	F	F	F	F

Card 5	1	2	3	4	5	6	7	8
Variable	XP	YP	ZP	A1	A2	A3	MACF	
Type	F	F	F	F	F	F	F	

Card 6	1	2	3	4	5	6	7	8
Variable	V1	V2	V3	D1	D2	D3	BETA	REF
Type	F	F	F	F	F	F	F	F

VARIABLE**DESCRIPTION**

MID	Material identification. A unique number or label must be specified (see *PART).
RO	Mass density
TA _i	Curve IDs defining the coefficients of thermal expansion for the six components of strain tensor as function of temperature.
C _{ij}	Curve IDs defining the 6 × 6 symmetric constitutive matrix in material coordinate system as function of temperature. Note that 1 corresponds to the <i>a</i> material direction, 2 to the <i>b</i> material direction, and 3 to the <i>c</i> material direction.
TGE	Curve ID defining the structural damping coefficient as function of temperature.
TREF	Reference temperature for the calculation of thermal loads or the definition of thermal expansion coefficients.
AOPT	Material axes option (see MAT_OPTIONTROPIC_ELASTIC, particularly the Material Directions section, for details): <p style="margin-left: 40px;">EQ.0.0: Locally orthotropic with material axes determined by element nodes 1, 2, and 4, as with *DEFINE_COORDINATE_NODES.</p>

VARIABLE	DESCRIPTION
EQ.1.0:	Locally orthotropic with material axes determined by a point, P , in space and the global location of the element center; this is the \mathbf{a} -direction. This option is for solid elements only.
EQ.2.0:	Globally orthotropic with material axes determined by vectors defined below, as with *DEFINE_COORDINATE_VECTOR
EQ.3.0:	Locally orthotropic material axes determined by a vector \mathbf{v} and the normal vector to the plane of the element. The plane of a solid element is the midsurface between the inner surface and outer surface defined by the first four nodes and the last four nodes of the connectivity of the element, respectively. Thus, for solid elements, AOPT = 3 is only available for hexahedrons. \mathbf{a} is determined by taking the cross product of \mathbf{v} with the normal vector, \mathbf{b} is determined by taking the cross product of the normal vector with \mathbf{a} , and \mathbf{c} is the normal vector. Then \mathbf{a} and \mathbf{b} are rotated about \mathbf{c} by an angle BETA. BETA may be set in the keyword input for the element or in the input for this keyword. Note that for solids, the material axes may be switched depending on the choice of MACF. The switch may occur before or after applying BETA depending on the value of MACF.
EQ.4.0:	Locally orthotropic in a cylindrical coordinate system with the material axes determined by a vector \mathbf{v} , and an originating point, P , which define the centerline axis. This option is for solid elements only.
LT.0.0:	The absolute value of AOPT is a coordinate system ID number (CID on *DEFINE_COORDINATE_OPTION).
XP, YP, ZP	Coordinates of point p for AOPT = 1 and 4
A1, A2, A3	Components of vector \mathbf{a} for AOPT = 2
MACF	Material axes change flag for solid elements: EQ.-4: Switch material axes b and c before BETA rotation EQ.-3: Switch material axes a and c before BETA rotation EQ.-2: Switch material axes a and b before BETA rotation EQ.1: No change, default

VARIABLE	DESCRIPTION
	EQ.2: Switch material axes <i>a</i> and <i>b</i> after BETA rotation EQ.3: Switch material axes <i>a</i> and <i>c</i> after BETA rotation EQ.4: Switch material axes <i>b</i> and <i>c</i> after BETA rotation
	<p>Figure M2-2 indicates when LS-DYNA applies MACF during the process to obtain the final material axes. If BETA on *ELEMENT_SOLID_{OPTION} is defined, then that BETA is used for the rotation for all AOPT options. Otherwise, if AOPT = 3, the BETA input on Card 6 rotates the axes. For all other values of AOPT, the material axes will be switched as specified by MACF, but no BETA rotation will be performed.</p>
D1, D2, D3	Components of vector d for AOPT = 2
V1, V2, V3	Components of vector v for AOPT = 3 and 4.
BETA	Material angle in degrees for AOPT = 3. It may be overwritten on the element card; see *ELEMENT_SOLID_ORTHO.
REF	Use reference geometry to initialize the stress tensor. The reference geometry is defined by the keyword: *INITIAL_FOAM_REFERENCE_GEOMETRY (see there for more details). EQ.0.0: Off EQ.1.0: On

***MAT_FLD_3-PARAMETER_BARLAT**

This is Material Type 190. This model was developed by Barlat and Lian [1989] for modeling sheets with anisotropic materials under plane stress conditions. This material allows the use of the Lankford parameters for the definition of the anisotropy. This particular development is due to Barlat and Lian [1989]. It has been modified to include a failure criterion based on the Forming Limit Diagram. The curve can be input as a load curve, or calculated based on the n-value and sheet thickness.

Card 1	1	2	3	4	5	6	7	8
Variable	MID	R0	E	PR	HR	P1	P2	ITER
Type	A8	F	F	F	F	F	F	F

Card 2	1	2	3	4	5	6	7	8
Variable	M	R00	R45	R90	LCID	E0	SPI	P3
Type	F	F	F	F	I	F	F	F

Card 3	1	2	3	4	5	6	7	8
Variable	AOPT	C	P	FLDCID	RN	RT	FLDSAFE	FLDNIPF
Type	F	F	F	I	F	F	F	F

Card 4	1	2	3	4	5	6	7	8
Variable				A1	A2	A3		
Type				F	F	F		

Card 5	1	2	3	4	5	6	7	8
Variable	V1	V2	V3	D1	D2	D3	BETA	
Type	F	F	F	F	F	F	F	

VARIABLE**DESCRIPTION**

MID	Material identification. A unique number or label not exceeding 8 characters must be specified.
RO	Mass density
E	Young's modulus, E
PR	Poisson's ratio, ν
HR	Hardening rule: EQ.1.0: linear (default) EQ.2.0: exponential (Swift) EQ.3.0: load curve EQ.4.0: exponential (Voce) EQ.5.0: exponential (Gosh) EQ.6.0: exponential (Hockett-Sherby)
P1	Material parameter: HR.EQ.1.0: Tangent modulus HR.EQ.2.0: k , strength coefficient for Swift exponential hardening HR.EQ.4.0: a , coefficient for Voce exponential hardening HR.EQ.5.0: k , strength coefficient for Gosh exponential hardening HR.EQ.6.0: a , coefficient for Hockett-Sherby exponential hardening

VARIABLE	DESCRIPTION
P2	Material parameter: HR.EQ.1.0: Yield stress HR.EQ.2.0: n , exponent for Swift exponential hardening HR.EQ.4.0: c , coefficient for Voce exponential hardening HR.EQ.5.0: n , exponent for Gosh exponential hardening HR.EQ.6.0: c , coefficient for Hocket-Sherby exponential hardening
ITER	Iteration flag for speed: ITER.EQ.0.0: fully iterative ITER.EQ.1.0: fixed at three iterations Generally, ITER = 0 is recommended. However, ITER = 1 is somewhat faster and may give acceptable results in most problems.
M	m , exponent in Barlat's yield surface
R00	R_{00} , Lankford parameter determined from experiments
R45	R_{45} , Lankford parameter determined from experiments
R90	R_{90} , Lankford parameter determined from experiments
LCID	load curve ID for the load curve hardening rule
E0	Material parameter HR.EQ.2.0: ϵ_0 for determining initial yield stress for Swift exponential hardening. (Default = 0.0) HR.EQ.4.0: b , coefficient for Voce exponential hardening HR.EQ.5.0: ϵ_0 for determining initial yield stress for Gosh exponential hardening. (Default = 0.0) HR.EQ.6.0: b , coefficient for Hocket-Sherby exponential hardening

VARIABLE	DESCRIPTION
SPI	<p>If ε_0 is zero above and HR.EQ.2.0. (Default = 0.0)</p> <p>EQ.0.0: $\varepsilon_0 = (E/k)^{1/(n-1)}$</p> <p>LE.0.2: $\varepsilon_0 = \text{SPI}$</p> <p>GT.0.2: $\varepsilon_0 = (\text{SPI}/k)^{1/n}$</p>
P3	<p>Material parameter:</p> <p>HR.EQ.5.0: p, parameter for Gosh exponential hardening</p> <p>HR.EQ.6.0: n, exponent for Hocket-Sherby exponential hardening</p>
AOPT	<p>Material axes option (see MAT_OPTION TROPIC_ELASTIC for a more complete description):</p> <p>EQ.0.0: locally orthotropic with material axes determined by element nodes 1, 2, and 4, as with *DEFINE_COORDINATE_NODES, and then rotated about the shell element normal by the angle BETA.</p> <p>EQ.2.0: globally orthotropic with material axes determined by vectors defined below, as with *DEFINE_COORDINATE_VECTOR.</p> <p>EQ.3.0: locally orthotropic material axes determined by rotating the material axes about the element normal by an angle, BETA, from a line in the plane of the element defined by the cross product of the vector v with the element normal.</p> <p>LT.0.0: the absolute value of AOPT is a coordinate system ID number (CID on *DEFINE_COORDINATE_NODES, *DEFINE_COORDINATE_SYSTEM or *DEFINE_COORDINATE_VECTOR). Available in R3 version of 971 and later.</p>
C	C in Cowper-Symonds strain rate model
P	p in Cowper-Symonds strain rate model, $p = 0.0$ for no strain rate effects

VARIABLE	DESCRIPTION
FLDCID	Load curve ID defining the Forming Limit Diagram. Minor engineering strains in percent are defined as abscissa values and Major engineering strains in percent are defined as ordinate values. The forming limit diagram is shown in Figure M39-1 . In defining the curve list pairs of minor and major strains starting with the left most point and ending with the right most point, see *DEFINE_CURVE.
RN	Hardening exponent equivalent to the n-value in a power law hardening law. If the parameter FLDCID is not defined, this value in combination with the value RT can be used to calculate a forming limit curve to allow for failure.
RT	Sheet thickness used for calculating a forming limit curve. This value does not override the sheet thickness in any way. It is only used in conjunction with the parameter RN to calculate a forming limit curve if the parameter FLDCID is not defined.
FLDSAFE	A safety offset of the forming limit curve. This value should be input as a percentage (ex. 10 not 0.10). This safety margin will be applied to the forming limit curve defined by FLDCID or the curve calculated by RN and RT.
FLDNIPF	<p data-bbox="488 1136 1154 1165">Numerical integration points failure treatment.</p> <p data-bbox="521 1188 1425 1335">GT.0.0: The number of element integration points that must fail before the element is deleted. By default, if one integration point has strains above the forming limit curve, the element is flagged for deletion.</p> <p data-bbox="521 1358 1425 1472">LT.0.0: The element is deleted when all integration points within a relative distance of $-FLDNIPF$ from the mid surface have failed (value between -1.0 and 0.0).</p>
A1, A2, A3	Components of vector a for AOPT = 2.
V1, V2, V3	Components of vector v for AOPT = 3.
D1, D2, D3	Components of vector d for AOPT = 2.
BETA	Material angle in degrees for AOPT = 0 and 3, may be overridden on the element card, see *ELEMENT_SHELL_BETA.

Remarks:

See material 36 for the theoretical basis.

The forming limit curve can be input directly as a curve by specifying a load curve id with the parameter FLDCID. When defining such a curve, the major and minor strains must be input as percentages.

Alternatively, the parameters RN and RT can be used to calculate a forming limit curve. The use of RN and RT is not recommended for non-ferrous materials. RN and RT are ignored if a non-zero FLDCID is defined.

The first history variable is the maximum strain ratio defined by:

$$\frac{\varepsilon_{\text{major_workpiece}}}{\varepsilon_{\text{major}_{fd}}}$$

corresponding to $\varepsilon_{\text{minor_workpiece}}$. A value between 0 and 1 indicates that the strains lie below the forming limit curve. Values above 1 indicate that the strains are above the forming limit curve.

*MAT_SEISMIC_BEAM

This is Material Type 191. This material enables lumped plasticity to be developed at the “node 2” end of Belytschko-Schwer beams (resultant formulation). The plastic yield surface allows for interaction between the two moments and the axial force.

Card Summary:

Card 1. This card is required.

MID	RO	E	PR	ASFLAG	FTYPE	DEGRAD	IFEMA
-----	----	---	----	--------	-------	--------	-------

Card 2. This card is required.

LCPMS	SFS	LCPMT	SFT	LCAT	SFAT	LCAC	SFAC
-------	-----	-------	-----	------	------	------	------

Card 3a. This card is included if and only if FTYPE = 1.

ALPHA	BETA	GAMMA	DELTA	A	B	FOFFS	
-------	------	-------	-------	---	---	-------	--

Card 3b. This card is included if and only if FTYPE = 2.

SIGY	D	W	TF	TW			
------	---	---	----	----	--	--	--

Card 3c. This card is included if and only if FTYPE = 4.

PHI_T	PHI_C	PHI_B					
-------	-------	-------	--	--	--	--	--

Card 3d. This card is included if and only if FTYPE = 5.

ALPHA	BETA	GAMMA	DELTA	PHI_T	PHI_C	PHI_B	
-------	------	-------	-------	-------	-------	-------	--

Card 4. This card is included if and only if IFEM > 0.

PR1	PR2	PR3	PR4				
-----	-----	-----	-----	--	--	--	--

Card 5. This card is included if and only if IFEM > 0.

TS1	TS2	TS3	TS4	CS1	CS2	CS3	CS4
-----	-----	-----	-----	-----	-----	-----	-----

Data Card Definitions:

Card 1	1	2	3	4	5	6	7	8
Variable	MID	RO	E	PR	ASFLAG	FTYPE	DEGRAD	IFEMA
Type	A8	F	F	F	F	I	I	I
Default	none	none	none	none	0.0	1	0	0

VARIABLE**DESCRIPTION**

MID	Material identification. A unique number or label not exceeding 8 characters must be specified.
RO	Mass density
E	Young's modulus.
PR	Poisson's ratio
ASFLAG	Axial strain definition for force-strain curves, degradation and FEMA output: EQ.0.0: true (log) total strain EQ.1.0: change in length EQ.2.0: nominal total strain EQ.3.0: FEMA plastic strain (= nominal total strain minus elastic strain)
FTYPE	Formulation type for interaction: EQ.1: parabolic coefficients, axial load and biaxial bending (default) EQ.2: Japanese code, axial force and major axis bending. EQ.4: AISC utilization calculation but no yielding EQ.5: AS4100 utilization calculation but no yielding
DEGRAD	Flag for degrading moment behavior (see Remark 5): EQ.0: behavior as in previous versions EQ.1: fatigue-type degrading moment-rotation behavior

VARIABLE	DESCRIPTION
	EQ.2: FEMA-type degrading moment-rotation behavior
IFEMA	Flag for input of FEMA thresholds: EQ.0: no input EQ.1: input of rotation thresholds only EQ.2: input of rotation and axial strain thresholds

Card 2	1	2	3	4	5	6	7	8
Variable	LCPMS	SFS	LCPMT	SFT	LCAT	SFAT	LCAC	SFAC
Type	F	F	F	F	F	F	F	F
Default	none	1.0	LCMPS	1.0	none	1.0	LCAT	1.0

VARIABLE	DESCRIPTION
LCPMS	Load curve ID giving plastic moment as a function of plastic rotation at node 2 about the local <i>s</i> -axis. See *DEFINE_CURVE.
SFS	Scale factor on <i>s</i> -moment at node 2
LCPMT	Load curve ID giving plastic moment as a function of plastic rotation at node 2 about local the <i>t</i> -axis. See *DEFINE_CURVE.
SFT	Scale factor on <i>t</i> -moment at node 2
LCAT	Load curve ID giving axial tensile yield force as a function of total tensile (elastic + plastic) strain or of elongation. See ASFLAG above. All values are positive. See *DEFINE_CURVE.
SFAT	Scale factor on axial tensile force
LCAC	Load curve ID giving compressive yield force as a function of total compressive (elastic + plastic) strain or of elongation. See ASFLAG above. All values are positive. See *DEFINE_CURVE.
SFAC	Scale factor on axial tensile force

FTYPE 1 Card. This card 3 format is used when FTYPE = 1 (default).

Card 3a	1	2	3	4	5	6	7	8
Variable	ALPHA	BETA	GAMMA	DELTA	A	B	FOFFS	
Type	F	F	F	F	F	F	F	
Default	Rem 1	Rem 1	Rem 1	Rem 1	Rem 1	Rem 1	0.0	

VARIABLE**DESCRIPTION**

ALPHA	Parameter to define yield surface
BETA	Parameter to define yield surface
GAMMA	Parameter to define yield surface
DELTA	Parameter to define yield surface
A	Parameter to define yield surface
B	Parameter to define yield surface
FOFFS	Force offset for yield surface (see Remark 2)

FTYPE 2 Card. This card 3 format is used when FTYPE = 2.

Card 3b	1	2	3	4	5	6	7	8
Variable	SIGY	D	W	TF	TW			
Type	F	F	F	F	F			
Default	none	none	none	none	none			

VARIABLE**DESCRIPTION**

SIGY	Yield stress of material
D	Depth of section used to calculate interaction curve
W	Width of section used to calculate interaction curve

VARIABLE	DESCRIPTION
----------	-------------

TF	Flange thickness of section used to calculate interaction curve
TW	Web thickness used to calculate interaction curve

FTYPE 4 Card. This card 3 format is used when FTYPE = 4.

Card 3c	1	2	3	4	5	6	7	8
Variable	PHI_T	PHI_C	PHI_B					
Type	F	F	F					
Default	0.8	0.85	0.9					

VARIABLE	DESCRIPTION
----------	-------------

PHI_T	Factor on tensile capacity, ϕ_t
PHI_C	Factor on compression capacity, ϕ_c
PHI_B	Factor on bending capacity, ϕ_b

FTYPE 5 Card. This card 3 format is used when FTYPE = 5.

Card 3d	1	2	3	4	5	6	7	8
Variable	ALPHA	BETA	GAMMA	DELTA	PHI_T	PHI_C	PHI_B	
Type	F	F	F	F	F	F	F	
Default	none	none	1.4	none	1.0	1.0	1.0	

VARIABLE	DESCRIPTION
----------	-------------

ALPHA	Parameter to define yield surface
BETA	Parameter to define yield surface
GAMMA	Parameter to define yield surface
DELTA	Parameter to define yield surface

VARIABLE	DESCRIPTION
PHI_T	Factor on tensile capacity, ϕ_t
PHI_C	Factor on compression capacity, ϕ_c
PHI_B	Factor on bending capacity, ϕ_b

FEMA Limits Card 1. Additional card for IFEMA > 0.

Card 4	1	2	3	4	5	6	7	8
Variable	PR1	PR2	PR3	PR4				
Type	F	F	F	F				
Default	0	0	0	0				

VARIABLE	DESCRIPTION
PR1 - PR4	Plastic rotation thresholds 1 to 4

FEMA Limits Card 2. Additional card for IFEMA = 2.

Card 5	1	2	3	4	5	6	7	8
Variable	TS1	TS2	TS3	TS4	CS1	CS2	CS3	CS4
Type	F	F	F	F	F	F	F	F
Default	0	0	0	0	TS1	TS2	TS3	TS4

VARIABLE	DESCRIPTION
TS1 - TS4	Tensile axial strain thresholds 1 to 4
CS1 - CS4	Compressive axial strain thresholds 1 to 4

Remarks:

- FTYPE 1.** Yield surface for formulation type 1 is of the form:

$$\psi = \left(\frac{M_s}{M_{ys}} \right)^\alpha + \left(\frac{M_t}{M_{yt}} \right)^\beta + A \left(\frac{F}{F_y} \right)^\gamma + B \left(\frac{F}{F_y} \right)^\delta - 1 ,$$

where

- M_s, M_t = moments about the local s and t axes
- M_{ys}, M_{yt} = current yield moments
- F = axial force
- F_y = yield force; LCAC in compression or LCAT in tension
- $\alpha, \beta, \gamma, \delta$ = input parameters; must be greater than or equal to 1.1
- A, B = input parameters

If $\alpha, \beta, \gamma, \delta, A$ and B are *all* set to zero, then the following default values are used:

Field	Default Value
ALPHA	2.0
BETA	2.0
GAMMA	2.0
DELTA	4.0
A	2.0
B	-1.0

2. **FOFFS.** FOFFS offsets the yield surface parallel to the axial force axis. It is the compressive axial force at which the maximum bending moment capacity about the local s -axis (determined by LCPMS and SFS) and that about the local t -axis (determined by LCPMT and SFT) occur. For steel beams and columns, the value of FOFFS is usually zero. For reinforced concrete beams, columns and shear walls, the maximum bending moment capacity occurs corresponding to a certain compressive axial force, FOFFS. The value of FOFFS can be input as either positive or negative. Internally, LS-DYNA converts FOFFS to, and regards compressive axial force as, negative.
3. **FTYPE 4.** Interaction surface FTYPE 4 calculates a utilization parameter using the yield force and moment data given on Card 2, but the elements remain elastic even when the forces or moments exceed yield values. This is done for consistency with the design code OBE AISC LRFD (2000). The utilization calculation is as follows:

$$\text{Utilization} = \frac{K_1 F}{\phi F_y} + \frac{K_2}{\phi_b} \left(\frac{M_s}{M_{ys}} + \frac{M_t}{M_{yt}} \right) ,$$

where M_s, M_t, M_{ys}, M_{yt} , and F_y are as defined in [Remark 1](#). ϕ is PHI_T under and PHI_C under compression. K_1 and K_2 are as follow:

$$K_1 = \begin{cases} 0.5 & \frac{F}{\phi F_y} < 0.2 \\ 1.0 & \frac{F}{\phi F_y} \geq 0.2 \end{cases}$$

$$K_2 = \begin{cases} 1.0 & \frac{F}{\phi F_y} < 0.2 \\ 8/9 & \frac{F}{\phi F_y} \geq 0.2 \end{cases}$$

4. **FTYPE 5.** Interaction surface FTYPE 5 is similar to FTYPE 4 (calculates a utilization parameter using the yield data, but the elements do not yield). The equations are taken from Australian code AS4100. The user must select appropriate values of α , β , γ and δ using the various clauses of Section 8 of AS4100. It is assumed that the local s -axis is the major axis for bending.

$$\text{Utilization} = \max(U_1, U_2, U_3, U_4, U_5)$$

where

$$U_1 = \frac{F}{\beta \phi_c F_{yc}} \quad \text{used for members in compression}$$

$$U_2 = \frac{F}{\phi_t F_{yt}} \quad \text{used for members in tension}$$

$$U_3 = \left[\frac{M_s}{K_2 \phi_b M_{ys}} \right]^\gamma + \left[\frac{M_t}{K_1 \phi_b M_{yt}} \right]^\gamma \quad \text{used for members in compression}$$

$$U_4 = \left[\frac{M_s}{K_4 \phi_b M_{ys}} \right]^\gamma + \left[\frac{M_t}{K_3 \phi_b M_{yt}} \right]^\gamma \quad \text{used for members in tension}$$

$$U_5 = \frac{F}{\phi_c F_{yc}} + \frac{M_s}{\phi_b M_{ys}} + \frac{M_t}{\phi_b M_{yt}} \quad \text{used for all members}$$

In the above, M_s , M_t , F , M_{ys} , M_{yt} , F_{yt} and F_{yc} are as defined in [Remark 1](#). K_1 , K_2 , K_3 , and K_4 are subject to a minimum value of 10^{-6} and defined as

$$K_1 = 1.0 - \frac{F}{\beta \phi_c F_{yc}}$$

$$K_2 = \min \left[K_1, \alpha \left(1.0 - \frac{F}{\delta \phi_c F_{yc}} \right) \right]$$

$$K_3 = 1.0 - \frac{F}{\phi_t F_{yt}}$$

$$K_4 = \min \left[K_3, \alpha \left(1.0 + \frac{F}{\phi_t F_{yt}} \right) \right]$$

α , β , γ , δ , ϕ_t , ϕ_c , and ϕ_b are input parameters.

5. **DEGRAD.** The option for degrading moment behavior changes the meaning of the plastic moment-rotation curve as follows:
- a) If $DEGRAD = 0$ (not recommended), the x -axis points on the curve represent current plastic rotation (meaning total rotation minus the elastic component of rotation). This quantity can be positive or negative depending on the direction of rotation; during hysteresis the behavior will repeatedly follow backwards and forwards along the same curve. The curve should include negative and positive rotation and moment values. This option is retained so that results from existing models will be unchanged.
 - b) If $DEGRAD = 1$, the x -axis points represent cumulative absolute plastic rotation. This quantity is always positive and increases whenever there is plastic rotation in either direction. Thus, during hysteresis, the yield moments are taken from points in the input curve with increasingly positive rotation. If the curve shows a degrading behavior (reducing moment with rotation), then, once degraded by plastic rotation, the yield moment can never recover to its initial value. This option can be thought of as having “fatigue-type” hysteretic damage behavior, where all plastic cycles contribute to the total damage.
 - c) If $DEGRAD = 2$, the x -axis points represent the high-tide value (always positive) of the plastic rotation. This quantity increases only when the absolute value of plastic rotation exceeds the previously recorded maximum. If smaller cycles follow a larger cycle, the plastic moment during the small cycles will be constant, since the high-tide plastic rotation is not altered by the small cycles. Degrading moment-rotation behavior is possible. This option can be thought of as showing rotation-controlled damage and follows the FEMA approach for treating fracturing joints.

DEGRAD applies also to the axial behavior. The same options are available as for rotation: $DEGRAD = 0$ gives unchanged behavior from previous versions; $DEGRAD = 1$ gives a fatigue-type behavior using cumulative plastic strain; and $DEGRAD = 2$ gives FEMA-type behavior, where the axial load capacity depends on the high-tide tensile and compressive strains. The definition of strain for this purpose is according to ASFLAG on Card 1 – it is expected that $ASFLAG = 2$ will be used with $DEGRAD = 2$. The “axial strain” variable plotted by post-processors is the variable defined by ASFLAG.

The output variables plotted as “plastic rotation” have special meanings for this material model– note that hinges form only at Node 2. “Plastic rotation at End 1” is really a high-tide mark of absolute plastic rotation at Node 2, defined as follows:

- d) Current plastic rotation is the total rotation minus the elastic component of rotation.

- e) Take the absolute value of the current plastic rotation, and record the maximum achieved up to the current time. This is the high-tide mark of plastic rotation.

If DEGRAD = 0, "Plastic rotation at End 2" is the current plastic rotation at Node 2. If DEGRAD = 1 or 2, "Plastic rotation at End 2" is the current total rotation at Node 2. The total rotation is a more intuitively understood parameter, such as for plotting hysteresis loops. However, with DEGRAD = 0, the previous meaning of that output variable has been retained such that results from existing models are unchanged.

FEMA thresholds are the plastic rotations at which the element is deemed to have passed from one category to the next, e.g. "Elastic", "Immediate Occupancy", "Life Safe", etc. The high-tide plastic rotation (maximum of Y and Z) is checked against the user-defined limits FEMA1, FEMA2, etc. The output flag is then set to 0, 1, 2, 3, or 4: 0 means that the rotation is less than FEMA1; 1 means that the rotation is between FEMA1 and FEMA2, and so on. By contouring this flag, it is possible to see quickly which joints have passed critical thresholds.

- 6. **Output.** For this material model, special output parameters are written to the d3plot and d3thdt files. The number of output parameters for beam elements is automatically increased to 20 (in addition to the six standard resultants) when parts of this material type are present. Some post-processors may interpret this data as if the elements were integrated beams with 4 integration points. Depending on the post-processor used, the data may be accessed as follows:

Extra Variable # (Integration Point 4 Description)	Data Description
16 (or Axial Stress)	FEMA rotation flag
17 (or XY Shear Stress)	current utilization
18 (or ZX Shear Stress)	maximum utilization to date
20 (or Axial Strain)	FEMA axial flag

"Utilization" is the yield parameter, where 1.0 is on the yield surface.

*MAT_SOIL_BRICK

Purpose: This is Material Type 192. It is intended for modeling over-consolidated clay.

Card Summary:

Card 1. This card is required.

MID	RO	RLAMBDA	RKAPPA	RIOTA	RBETA1	RBETA2	RMU
-----	----	---------	--------	-------	--------	--------	-----

Card 2. This card is required.

RNU	RLCID	TOL	PGCL	SUB-INC	BLK	GRAV	THEORY
-----	-------	-----	------	---------	-----	------	--------

Card 3a. This card is included only if THEORY = 4 or 104.

RVHHH						STRSUB	
-------	--	--	--	--	--	--------	--

Card 3b. This card is included only if THEORY = 204 or 304.

RVHHH						STRSUB	CRFLG
-------	--	--	--	--	--	--------	-------

Card 3c. This card is included only if THEORY = 7 or 107.

EHEV	GHHGVH	PRHH	CAP				
------	--------	------	-----	--	--	--	--

Card 4. This card is included only if THEORY = 204 or 304 and CRFLG > 0.

SLRATIO	BETAC	EPSDOT1	EPSDOT2				
---------	-------	---------	---------	--	--	--	--

Data Card Definitions:

Card 1	1	2	3	4	5	6	7	8
Variable	MID	RO	RLAMBDA	RKAPPA	RIOTA	RBETA1	RBETA2	RMU
Type	A	F	F	F	F	F	F	F
Default	none	none	none	none	none	none	none	1.0

VARIABLE	DESCRIPTION
MID	Material identification. A unique number or label must be specified (see *PART).
RO	Mass density
RLAMBDA	Material coefficient, see Remark 1 .
RKAPPA	Material coefficient, see Remark 1 .
RIOTA	Material coefficient, see Remark 1 .
RBETA1	Material coefficient, see Remark 1 .
RBETA2	Material coefficient, see Remark 1 .
RMU	Shape factor coefficient. This parameter will modify the shape of the yield surface used. A value of 1.0 implies a von Mises type surface, while 1.1 to 1.25 is more indicative of soils. The default value is 1.0. See Remarks 1 and 9 .

Card 2	1	2	3	4	5	6	7	8
Variable	RNU	RLCID	TOL	PGCL	SUB-INC	BLK	GRAV	THEORY
Type	F	F	F	F	F	F	F	I
Default	none	none	0.0005	none	none	none	9.807	0

VARIABLE	DESCRIPTION
RNU	Poisson's ratio. See Remarks 1 and 2 .
RLCID	Load curve ID (see *DEFINE_CURVE) consisting of up to 10 points defining nonlinear response in terms of stiffness degradation. The x -axis is strain ("string length"), and the y -axis is the ratio of secant stiffness to small-strain stiffness. See Remarks 3 and 12 .
TOL	User defined tolerance for convergence checking. Default value is set to 0.0005 (recommended). See Remark 11 .

VARIABLE	DESCRIPTION
PGCL	Pre-consolidation ground level. This parameter defines the maximum surface level (relative to $z = 0.0$ in the model) of the soil throughout geological history which is used calculate the maximum overburden pressure on the soil elements. See Remark 6 .
SUB-INC	User defined strain increment size. A typical value is 0.005. This is the maximum strain increment permitted in the iteration scheme within the material model. If the value is exceeded, a warning is echoed to the d3hsp file. See Remark 11 .
BLK	The elastic bulk stiffness of the soil which is used for contact stiffness only.
GRAV	The gravitational acceleration which is used to calculate the element stresses due to the overlying soil. Default is set to 9.807 m/s ² .
THEORY	Version of material subroutines used (see Remarks 7 and 8): EQ.0: 1995 version (default) EQ.4: 2003 version, load/unload initialization EQ.7: 2003 version, load/unload initialization, anisotropy from Ellison et al (2012) EQ.104: 2003 version, load/unload/reload initialization EQ.107: 2003 version, load/unload/reload initialization, anisotropy from Ellison et al (2012) EQ.204: 2015 version, load/unload initialization EQ.304: 2015 version, load/unload/reload initialization

Define Card 3a only if THEORY = 4 or 104. Omit otherwise.

Card 3a	1	2	3	4	5	6	7	8
Variable	RVHHH						STRSUB	
Type	F						F	
Default	0.0						0.001	

VARIABLE	DESCRIPTION
RVHHH	Anisotropy parameter: shear modulus in vertical planes divided by shear modulus in horizontal plane. If this field is blank or zero, isotropic behavior is assumed. See Remark 10 .
STRSUB	Strain limit, used to determine whether subcycling within the material model is required (recommended value: 0.001)

Define Card 3b only if THEORY = 204 or 304. Omit otherwise.

Card 3b	1	2	3	4	5	6	7	8
Variable	RVHHH						STRSUB	CRFLG
Type	F						F	F
Default	0.0						0.001	0.0

VARIABLE	DESCRIPTION
RVHHH	Anisotropy parameter: shear modulus in vertical planes divided by shear modulus in horizontal plane. If this field is blank or zero, isotropic behavior is assumed. See Remark 10 .
STRSUB	Strain limit, used to determine whether subcycling within the material model is required (recommended value: 0.001)
CRFLG	Creep flag: EQ.0: No creep EQ.24: Creep activated; see Card 4.

Define Card 3c only if THEORY = 7 or 107. Omit otherwise.

Card 3c	1	2	3	4	5	6	7	8
Variable	EHEV	GHHGVH	PRHH	CAP				
Type	F	F	F	F				
Default	0.0	0.0	0.0	0.0				

VARIABLE	DESCRIPTION
EHEV	Anisotropy parameter: Young's modulus in horizontal directions divided by Young's modulus in vertical direction. See Remarks 1 and 10 .
GHHGVH	Anisotropy parameter: shear modulus in horizontal plane divided by shear modulus in vertical planes. See Remarks 1 and 10 .
PRHH	Anisotropy parameter: Poisson's ratio in horizontal plane. See Remarks 1 and 10 .
CAP	Anisotropy parameter. See Remarks 1 and 10 .

Define Card 4 only if THEORY = 204 or 304 and CRFLG > 0. Omit otherwise.

Card 4	1	2	3	4	5	6	7	8
Variable	SLRATIO	BETAC	EPSDOT1	EPSDOT2				
Type	F	F	F	F				
Default	0.0	0.0	0.0	0.0				

VARIABLE	DESCRIPTION
SLRATIO	Creep parameter, see Remark 12
BETAC	Creep parameter, see Remark 12
EPSDOT1	Creep parameter: reference strain rate for volumetric strains. See Remark 12 .
EPSDOT2	Creep parameter: reference strain rate for shear strains. See Remark 12 .

Remarks:

1. **Material Behavior and References.** The material model consists of up to 10 nested elasto-plastic yield surfaces defined in a transformed stress-strain space, termed "BRICK" space. The sizes of the yield surfaces are given in terms of BRICK strains and are called "string-lengths". Explanation of the input parameters and underlying concepts may be found in Simpson (1992), Lehane &

Simpson (2000), and Ellison et al (2012). The input parameters correspond to those described in Ellison et al as follows:

LS-DYNA	Ellison et al
RLAMBDA	λ
RKAPPA	κ
RIOTA	ι
RBETA1	β^G
RBETA2	β^ϕ
RMU	μ
RNU	ν
EHEV	E_h/E_v
GHHGVH	G_{hh}/G_{vh}
PRHH	ν_{hh}
CAP	ζ

See Table 3 in Ellison et al for example input parameter values.

2. **Elastic Stiffness.** The elastic bulk modulus is given by p'/ι , where p' is the current mean effective stress (compression positive), and the small-strain elastic shear modulus is calculated from the bulk modulus and Poisson's ratio RNU.
3. **Nonlinear Stress-Strain Response.** The curve RLCID defines the nonlinear behavior in terms of secant stiffness degradation. The same curve is assumed to apply to all six BRICK stress-strain components. For example, shear in the xz -plane will follow the curve, such that the x -axis points correspond to shear angle γ_{xz} , while the y -axis contains G/G_{max} , where G is the secant stiffness (equal to τ_{xz}/γ_{xz}) and G_{max} is the small-strain elastic shear modulus.
4. **Model Requirements.** This material type requires that the model be oriented such that the z -axis is defined in the upward direction. Compressive initial stress must be defined, using, for example, *INITIAL_STRESS_SOLID or *INITIAL_STRESS_DEPTH. Stresses must remain compressive throughout the analysis.
5. **Units.** The recommended unit system is kiloNewtons, meters, seconds, tonnes. There are some built-in defaults that assume stress units of kN/m².

6. **Over-Consolidated Clays.** Over-consolidated clays have suffered previous loading to higher stress levels than are present at the start of the analysis due to phenomena such as ice sheets during previous ice ages, or the presence of soil or rock that has subsequently been eroded. The maximum vertical stress during that time is assumed to be:

$$\sigma_{V,MAX} = RO \times GRAV \times (PGCL - Z_{el}) ,$$

where

RO, GRAV, and PGCL = input parameters

Z_{el} = z coordinate of center of element

Since that time, the material has been unloaded until the vertical stress equals the user-defined initial vertical stress. The previous load/unload history has a significant effect on the subsequent behavior. For example, the horizontal stress in an over-consolidated clay may be greater than the vertical stress.

7. **Initialization.** This material model initializes each element with a load/unload cycle under uniaxial vertical strain conditions. The element is loaded up to a vertical stress of $\sigma_{V,MAX}$ (defined in [Remark 6](#) above) and then unloaded to the user-defined initial vertical stress $\sigma_{V,USER}$ (see *INITIAL_STRESS_SOLID or *INITIAL_STRESS_DEPTH). During this initialization cycle, the stresses and history variables are updated using the same constitutive behavior as during the main analysis. Therefore, the horizontal stress at the start of the analysis $\sigma_{H,ACTUAL}$ (as seen in the results files at time zero) is an output of the initialization process and will be different from the user-defined initial horizontal stress $\sigma_{H,USER}$; the latter is ignored. Optionally, initialization may be switched to a load/unload/reload cycle (see input settings of THEORY). In this case, the element is loaded up to a vertical stress of $\sigma_{V,MAX}$, unloaded to a stress $\sigma_{V,MIN}$ which is less than $\sigma_{V,USER}$, and then reloaded to $\sigma_{V,USER}$. The value of $\sigma_{V,MIN}$ is calculated automatically to try to minimize the difference between $\sigma_{H,ACTUAL}$ and $\sigma_{H,USER}$.
8. **Material Subroutine Version.** This material model is developed for a Geotechnical FE program (Oasys Ltd.'s SAFE) written by Arup. The default THEORY = 0 gives a vectorized version ported from SAFE in the 1990's. Since then the material model has been developed further in SAFE, with versions ported to LSDYNA in 2003 (THEORY = 4 and 104) and 2015 (THEORY = 204 and 304); these are not vectorized and will run more slowly on most computer platforms. Nevertheless, the 2015 version is recommended. THEORY = 0, 4, and 104 are retained only for backward compatibility.
9. **Shape Factor.** The shape factor for a typical soil would be 1.25. Do not use values higher than 1.35.

10. **Anisotropy.** Anisotropy is treated by applying stretch factors to the strain axis of the stress-strain curves for certain BRICK shear components. It may be defined by *either* using THEORY = 204 or 304 together with RVHHH on Card 3b *or* using THEORY = 7 or 107 with the parameters on Card 3c. Using THEORY = 4 or 104 with non-zero anisotropy parameters on Card 3a is permitted but not recommended. See Ellison et al (2012) for description of the anisotropy effects modelled by THEORY = 7/107 and the meaning of the parameters on Card 3c. If anisotropy is not required, use THEORY = 204 or 304 and leave Card 3b blank. “Vertical” and “horizontal” are defined in the global coordinate system with “vertical” being the global z-axis.
11. **TOL and SUBINC.** These parameters usually have little influence on the result. Smaller values may sometimes improve accuracy, at cost of greater run times.
12. **Creep.** Creep is implemented by scaling the strain “string lengths” (see RLCID) as a function of strain rate:

$$S = \text{SLRATIO} \times S_{\text{RLCID}} \left[1 + \text{BETAC} \times \ln \left(\frac{|\dot{\epsilon}|}{\dot{\epsilon}_{\text{ref}}} + 1 \right) \right]$$

Where S is string length; S_{RLCID} are the string lengths in the curve RLCID; SLRATIO and BETAC are input parameters on Card 4; $|\dot{\epsilon}|$ is strain rate; and $\dot{\epsilon}_{\text{ref}}$ is input parameter EPSDOT1 or EPSDOT2 for volumetric and shear strains, respectively. Note that $\text{SLRATIO} \times S_{\text{RLCID}}$ gives the string lengths for zero strain rate.

References:

- [1] Simpson, B., “Retaining structures: displacement and design”, *Géotechnique*, Vol. 42, No. 4, 539-576, (1992).
- [2] Lehane, B. & Simpson, B., “Modelling glacial till conditions using a Brick soil model”, *Can. Geotech. J.* Vol. 37, No. 5, 1078–1088 (2000).
- [3] Ellison, K., Soga, K., & Simpson, B., “A strain space soil with evolving stiffness memory”, *Géotechnique*, Vol. 62, No. 7, 627-641 (2012).

***MAT_DRUCKER_PRAGER**

This is Material Type 193. This material enables soil to be modeled effectively. The parameters used to define the yield surface are familiar geotechnical parameters (such as angle of friction). The modified Drucker-Prager yield surface is used in this material model, enabling the shape of the surface to be distorted into a more realistic definition for soils.

Card 1	1	2	3	4	5	6	7	8
Variable	MID	RO	GMOD	RNU	RKF	PHI	CVAL	PSI
Type	A	F	F	F	F	F	F	F
Default	none	none	none	none	1.0	none	none	0.0

Card 2	1	2	3	4	5	6	7	8
Variable	STR_LIM							
Type	F							
Default	0.005							

Card 3	1	2	3	4	5	6	7	8
Variable	GMODDP	PHIDP	CVALDP	PSIDP	GMODGR	PHIGR	CVALGR	PSIGR
Type	F	F	F	F	F	F	F	F
Default	0.0	0.0	0.0	0.0	0.0	0.0	0.0	0.0

VARIABLE**DESCRIPTION**

MID	Material identification. A unique number or label must be specified (see *PART).
RO	Mass density

VARIABLE	DESCRIPTION
GMOD	Elastic shear modulus
RNU	Poisson's ratio
RKF	Failure surface shape parameter
PHI	Angle of friction (radians)
CVAL	Cohesion value
PSI	Dilation angle (radians)
STR_LIM	Minimum shear strength of material is given by STR_LIM × CVAL
GMODDP	Depth at which shear modulus (GMOD) is correct
PHIDP	Depth at which angle of friction (PHI) is correct
CVALDP	Depth at which cohesion value (CVAL) is correct
PSIDP	Depth at which dilation angle (PSI) is correct
GMODGR	Gradient at which shear modulus (GMOD) increases with depth
PHIGR	Gradient at which friction angle (PHI) increases with depth
CVALGR	Gradient at which cohesion value (CVAL) increases with depth
PSIGR	Gradient at which dilation angle (PSI) increases with depth

Remarks:

1. **Orientation.** This material type requires the model to be oriented such that the Z-axis is defined in the upward direction. The key parameters are defined such that they may vary with depth (i.e. the Z-axis).
2. **Shape Factor.** The shape factor for a typical soil would be 0.8 but should not be pushed further than 0.75.
3. **STR_LIM.** If STR_LIM is set to less than 0.005, the value is reset to 0.005.
4. **Yield Function.** The yield function is defined as:

$$t - p \times \tan \beta - d = 0$$

where:

Variable	Description
p	Hydrostatic pressure, $p = J_1/3$
t	$t = q/2 (a - b(r/q)^3)$
q	von Mises stress, $q = \sqrt{3J_2}$
a	$a = 1 + 1/K$
b	$b = 1 - 1/K$
K	Input field RKF
r	$r = (27J_3/2)^{1/3}$
J_2	Second deviatoric stress invariant
J_3	Third deviatoric stress invariant
$\tan \beta$	$\tan \beta = 6 \sin \varphi / (3 - \sin \varphi)$
d	$d = 6C \cos \varphi / (3 - \sin \varphi)$
φ	Input field PHI
C	Input field CVAL

5. **Executable Precision.** We recommend using this material with a double precision executable.
6. **Output.** This remark applies to versions R14 and onwards. "Plastic Strain" is the deviatoric plastic strain, defined in the same way as for material types 3, 24, etc. Extra history variables may be requested for solid elements (NEIPH on *DATABASE_EXTENT_BINARY). They are described in the following table.

History Variable #	Description
1	Volumetric strain
2	Mobilized fraction (= 1 when on yield surface)
3	At-rest coefficient (ratio of horizontal stress to vertical stress)
4	Friction angle in radians (differs from input parameter PHI only if PHIDP and PHIGR are used)

History Variable #	Description
5	Cohesion (differs from input parameter CVAL only if CVALDP and CVALGR are used)
6	Dilation angle in radians (differs from input parameter PSI only if PSIDP and PSIGR are used)
7	Shear modulus (differs from input parameter GMOD only if GMODDP and GMODGR are used)

*MAT_RC_SHEAR_WALL

Purpose: This is Material Type 194. It is for shell elements only. It uses empirically-derived algorithms to model the effect of cyclic shear loading on reinforced concrete walls. It is primarily intended for modeling squat shear walls, but can also be used for slabs. Because the combined effect of concrete and reinforcement is included in the empirical data, crude meshes can be used. The model has been designed such that the minimum amount of input is needed: generally, only the variables on the first card need to be defined.

NOTE: This material does not support specification of a material angle, β_i , for each through-thickness integration point of a shell.

Card 1	1	2	3	4	5	6	7	8
Variable	MID	RO	E	PR	TMAX			I
Type	A8	F	F	F	F			
Default	none	none	none	0.0	0.0			

Include the following data if “Uniform Building Code” formula for maximum shear strength or tensile cracking are required – otherwise leave blank.

Card 2	1	2	3	4	5	6	7	8
Variable	FC	PREF	FYIELD	SIG0	UNCONV	ALPHA	FT	ERIENF
Type	F	F	F	F	F	F	F	F
Default	0.0	0.0	0.0	0.0	0.0	0.0	0.0	0.0

Card 3	1	2	3	4	5	6	7	8
Variable	A	B	C	D	E	F		
Type	F	F	F	F	F	F		
Default	0.05	0.55	0.125	0.66	0.25	1.0		

Card 4	1	2	3	4	5	6	7	8
Variable	Y1	Y2	Y3	Y4	Y5			
Type	F	F	F	F	F			
Default	0.0	0.0	0.0	0.0	0.0			

Card 5	1	2	3	4	5	6	7	8
Variable	T1	T2	T3	T4	T5			
Type	F	F	F	F	F			
Default	0.0	0.0	0.0	0.0	0.0			

Card 6	1	2	3	4	5	6	7	8
Variable	AOPT							
Type	F							
Default	0.0							

Card 7	1	2	3	4	5	6	7	8
Variable	XP	YP	ZP	A1	A2	A3		
Type	F	F	F	F	F	F		
Default	0.0	0.0	0.0	0.0	0.0	0.0		

Card 8	1	2	3	4	5	6	7	8
Variable	V1	V2	V3	D1	D2	D3	BETA	
Type	F	F	F	F	F	F	F	
Default	0.0	0.0	0.0	0.0	0.0	0.0	0.0	

VARIABLE**DESCRIPTION**

MID	Material identification. A unique number or label not exceeding 8 characters must be specified.
RO	Mass density
E	Young's Modulus
PR	Poisson's Ratio
TMAX	Ultimate in-plane shear stress. If set to zero, LS-DYNA will calculate TMAX based on the formulae in the Uniform Building Code, using the data on card 2. See Remarks.
FC	Unconfined Compressive Strength of concrete (used in the calculation of ultimate shear stress; crushing behavior is not modeled)
PREF	Percent reinforcement, e.g. if 1.2% reinforcement, enter 1.2
FYIELD	Yield stress of reinforcement
SIG0	Overburden stress (in-plane compressive stress) - used in the calculation of ultimate shear stress. Usually sig0 is left as zero.

VARIABLE	DESCRIPTION
UCONV	<p>Unit conversion factor. UCONV is expected to be set such that,</p> $UCONV = \sqrt{1.0 \text{ PSI in the model's stress units.}}$ <p>This used to convert the ultimate tensile stress of concrete which is expressed as \sqrt{FC} where FC is given in PSI. Therefore a unit conversion factor of $\sqrt{\text{PSI}/\text{Stress Unit}}$ is required. Examples:</p> $UCONV = 83.3 = \sqrt{6894} \text{ if stress unit is N/m}^2$ $UCONV = 0.083 \text{ if stress unit is MN/m}^2 \text{ or N/mm}^2$
ALPHA	Shear span factor - see below.
FT	Cracking stress in direct tension - see notes below. Default is 8% of the cylinder strength.
ERIENF	Young's Modulus of reinforcement. Used in calculation of post-cracked stiffness - see notes below.
A	Hysteresis constants determining the shape of the hysteresis loops.
B	Hysteresis constants determining the shape of the hysteresis loops.
C	Hysteresis constants determining the shape of the hysteresis loops.
D	Hysteresis constants determining the shape of the hysteresis loops.
E	Hysteresis constants determining the shape of the hysteresis loops.
F	Strength degradation factor. After the ultimate shear stress has been achieved, F multiplies the maximum shear stress from the curve for subsequent reloading. F = 1.0 implies no strength degradation (default). F = 0.5 implies that the strength is halved for subsequent reloading.
Y1, Y2, ..., Y5	Engineering shear strain points on stress-strain curve. By default these are calculated from the values on card 1. See below for more guidance.
T1, T2, ..., T5	Shear stress points on stress-strain curve. By default these are calculated from the values on card 1. See below for more guidance.
AOPT	Material axes option:

VARIABLE	DESCRIPTION
	EQ.0.0: locally orthotropic with material axes determined by element nodes as shown in Figure M2-1 , and then rotated about the shell element normal by the angle BETA. Nodes 1, 2, and 4 of an element are identical to the nodes used for the definition of a coordinate system as by *DEFINE_COORDINATE_NODES.
	EQ.2.0: globally orthotropic with material axes determined by vectors defined below, as with *DEFINE_COORDINATE_VECTOR.
	EQ.3.0: applicable to shell elements only. This option determines locally orthotropic material axes by offsetting the material axes by an angle to be specified from a line in the plane of the shell determined by taking the cross product of the vector \mathbf{v} defined below with the shell normal vector.
	LT.0.0: the absolute value of AOPT is a coordinate system ID number (CID on *DEFINE_COORDINATE_NODES, *DEFINE_COORDINATE_SYSTEM or *DEFINE_COORDINATE_VECTOR). Available in R3 version of 971 and later.
XP, YP, ZP	Coordinates of point \mathbf{p} for AOPT = 1.
A1, A2, A3	Components of vector \mathbf{a} for AOPT = 2.
V1, V2, V3	Components of vector \mathbf{v} for AOPT = 3.
D1, D2, D3	Components of vector \mathbf{d} for AOPT = 2.
BETA	Material angle in degrees for AOPT = 0 and 3, may be overridden on the element card, see *ELEMENT_SHELL_BETA.

Remarks:

The element is linear elastic except for in-plane shear and tensile cracking effects. Crushing due to direct compressive stresses are modeled only insofar as there is an in-plane shear stress component. It is not recommended that this model be used where nonlinear response to direct compressive or loads is important.

Note that the in-plane shear stress t_{xy} is defined as the shear stress in the element's local x - y plane. This is not necessarily equal to the maximum shear stress in the plane: for example, if the principal stresses are at 45 degrees to the local axes, t_{xy} is zero. Therefore

it is important to ensure that the local axes are appropriate - for a shear wall the local axes should be vertical or horizontal. By default, local x points from node 1 to node 2 of the element. It is possible to change the local axes by using $AOPT > 0$.

If TMAX is set to zero, the ultimate shear stress is calculated using a formula in the Uniform Building Code 1997, section 1921.6.5:

$$TMAX_{UBC} = UCONV \times ALPHA \times \sqrt{FC} + RO \times FY$$

where,

UCONV = unit conversion factor, see variable list

ALPHA = aspect ratio

= 2.0 for $h/l \in (2.0, \infty)$ increases linearly to 3.0 for $h/l \in (2.0, 1.5)$

FC = unconfined compressive strength of concrete

RO = fraction of reinforcement

= (percent reinforcement)/100

FY = yield stress of reinforcement

To this we add shear stress due to the overburden to obtain the ultimate shear stress:

$$TMAX_{UBC} = TMAX_{UBC} + SIG0$$

where

SIG0 = in plane compressive stress under static equilibrium conditions

The UBC formula for ultimate shear stress is generally conservative (predicts that the wall is weaker than shown in test), sometimes by 50% or more. A less conservative formula is that of Fukuzawa:

$$TMAX = \max \left[\left(0.4 + \frac{A_c}{A_w} \right), 1 \right] \times 2.7 \times \left(1.9 + \frac{M}{L_v} \right) \times UCONV + \sqrt{FC} + 0.5 \\ \times RO \times FY + SIG0$$

where

A_C = Cross-sectional area of stiffening features such as columns or flanges

A_w = Cross-sectional area of wall

M/L_v = Aspect ratio of wall height/length

Other terms are as above. This formula is not included in the material model: TMAX should be calculated by hand and entered on Card 1 if the Fukuzawa formula is required.

It should be noted that none of the available formulae, including Fukuzawa, predict the ultimate shear stress accurately for all situations. Variance from the experimental results can be as great as 50%.

The shear stress vs shear strain curve is then constructed automatically as follows, using the algorithm of Fukuzawa extended by Arup:

1. Assume ultimate engineering shear strain, $\gamma_u = 0.0048$
2. First point on curve, corresponding to concrete cracking, is at

$$\left(0.3 \times \frac{TMAX}{G}, 0.3 \times TMAX\right),$$

where G is the elastic shear modulus given by

$$G = \frac{E}{2(1 + \nu)}.$$

3. Second point, corresponding to the reinforcement yield, is at
4. Third point, corresponding to the ultimate strength, is at
5. Fourth point, corresponding to the onset of strength reduction, is at
6. Fifth point, corresponding to failure is at

$$(0.5 \times \gamma_u, 0.8 \times TMAX).$$

$$(\gamma_u, TMAX).$$

$$(2\gamma_u, TMAX).$$

$$(3\gamma_u, 0.6 \times TMAX).$$

After failure, the shear stress drops to zero. The curve points can be entered by the user if desired, in which case they over-ride the automatically calculated curve. However, it is anticipated that in most cases the default curve will be preferred due to ease of input.

Hysteresis follows the algorithm of Shiga as for the squat shear wall spring (see *MAT_SPRING_SQUAT_SHEARWALL). The hysteresis constants which are defined in fields A, B, C, D, and E can be entered by the user if desired, but it is generally recommended that the default values be used.

Cracking in tension is checked for the local x and y directions only – this is calculated separately from the in-plane shear. A trilinear response is assumed, with turning points at concrete cracking and reinforcement yielding. The three regimes are:

1. Pre-cracking, linear elastic response is assumed using the overall Young's Modulus on Card 1.
2. **Cracking occurs in the local x or y directions when the tensile stress in that direction exceeds the concrete tensile strength FT** (if not input on Card 2, this defaults to 8% of the compressive strength FC). Post-cracking, a linear stress-strain response is assumed up to reinforcement yield at a strain defined by reinforcement yield stress divided by reinforcement Young's Modulus.

3. Post-yield, a constant stress is assumed (no work hardening).

Unloading returns to the origin of the stress-strain curve.

For compressive strains the response is always linear elastic using the overall Young's Modulus on Card 1.

If insufficient data is entered, no cracking occurs in the model. As a minimum, FC and FY are needed.

Extra variables are available for post-processing as follows:

Extra variable 1: Current engineering shear strain

Extra variable 2: Shear status: 0, 1, 2, 3, 4, or 5– see below

Extra variable 3: Maximum direct strain so far in local x direction (for tensile cracking)

Extra variable 4: Maximum direct strain so far in local y direction (for tensile cracking)

Extra variable 5: Tensile status: 0, 1 or 2 = elastic, cracked, or yielded respectively.

The shear status shows how far along the shear stress-strain curve each element has progressed, e.g. status 2 means that the element has passed the second point on the curve. These status levels correspond to performance criteria in building design codes such as FEMA.

***MAT_CONCRETE_BEAM**

This is Material Type 195 for beam elements. An elasto-plastic material with an arbitrary stress as a function of strain curve and arbitrary strain rate dependency can be defined. Failure based on a plastic strain or a minimum time step size can be defined. See Remarks below.

Card 1	1	2	3	4	5	6	7	8
Variable	MID	RO	E	PR	SIGY	ETAN	FAIL	TDEL
Type	A8	F	F	F	F	F	F	F
Default	none	none	none	none	none	0.0	10 ²⁰	10 ²⁰

Card 2	1	2	3	4	5	6	7	8
Variable	C	P	LCSS	LCSR				
Type	F	F	F	F				
Default	0	0	0	0				

Card 3	1	2	3	4	5	6	7	8
Variable	NOTEN	TENCUT	SDR					
Type	I	F	F					
Default	0	10 ¹⁵	0.0					

VARIABLE**DESCRIPTION**

MID Material identification. A unique number or label not exceeding 8 characters must be specified.

RO Mass density

VARIABLE	DESCRIPTION
E	Young's modulus
PR	Poisson's ratio
SIGY	Yield stress
ETAN	Tangent modulus; ignored if LCSS > 0
FAIL	Failure flag: LT.0.0: user defined failure subroutine is called to determine failure. EQ.0.0: failure is not considered. This option is recommended if failure is not of interest since many calculations will be saved. GT.0.0: plastic strain to failure. When the plastic strain reaches this value, the element is deleted from the calculation.
TDEL	Minimum time step size for automatic element deletion.
C	Strain rate parameter, C ; see Remarks below.
P	Strain rate parameter, p ; see Remarks below.
LCSS	Load curve ID or Table ID. Load curve ID defining effective stress as a function of effective plastic strain. The table ID defines for each strain rate value a load curve ID giving the stress as a function of effective plastic strain for that rate; see Figure M16-1 Stress as a function of effective plastic strain curve for the lowest value of strain rate is used if the strain rate falls below the minimum value. Likewise, the stress as a function of effective plastic strain curve for the highest value of strain rate is used if the strain rate exceeds the maximum value. The strain rate parameters (C and p) and the curve ID, LCSR, are ignored if a Table ID is defined.
LCSR	Load curve ID defining strain rate scaling effect on yield stress
NOTEN	No-tension flag: EQ.0: beam takes tension. EQ.1: beam takes no tension. EQ.2: beam takes tension up to value given by TENCUT.
TENCUT	Tension cutoff value

VARIABLE	DESCRIPTION
SDR	Stiffness degradation factor

Remarks:

The stress strain behavior may be treated using a bilinear stress strain curve through defining the tangent modulus, ETAN. An effective stress as a function of effective plastic strain curve (LCSS) may be input instead of defining ETAN. The cost is roughly the same for either approach. The most general approach is to use the table definition (LCSS) discussed below.

Three options to account for strain rate effects are possible.

1. Strain rate may be accounted for using the Cowper and Symonds model which scales the yield stress with the factor

$$1 + \left(\frac{\dot{\epsilon}}{C}\right)^{1/p}$$

where $\dot{\epsilon}$ is the strain rate. $\dot{\epsilon} = \sqrt{\dot{\epsilon}_{ij}\dot{\epsilon}_{ij}}$.

2. For complete generality a load curve (LCSR) to scale the yield stress may be input instead. In this curve the scale factor as a function of strain rate is defined.
3. If different stress as a function of strain curves can be provided for various strain rates, the option using the reference to a table (LCSS) can be used.

***MAT_GENERAL_SPRING_DISCRETE_BEAM**

This is Material Type 196. This model permits elastic and elastoplastic springs with damping to be represented with a discrete beam element of type 6 by using six springs each acting about one of the six local degrees-of-freedom. For elastic behavior, a load curve defines force or moment as a function of displacement or rotation. For inelastic behavior, a load curve defines yield force or moment as a function of plastic deflection or rotation, which can vary in tension and compression.

The two nodes defining a beam may be coincident to give a zero length beam or offset to give a finite length beam. For finite length discrete beams, the absolute value of the field SCOOR in the *SECTION_BEAM input should be set to a value of 2.0, which causes the local *r*-axis to be aligned along the two nodes of the beam to give physically correct behavior. The distance between the nodes of a beam should not affect the behavior of this material model. A triad is used to orient the beam for the directional springs.

Card Summary:

Card 1. This card is required.

MID	RO						DOSPOT
-----	----	--	--	--	--	--	--------

Card 2. For each active degree of freedom include a pair of Cards 2 and 3. This data is terminated by the next keyword ("*") card or when all six degrees of freedom have been specified.

DOF	TYPE	K	D	CDF	TDF		
-----	------	---	---	-----	-----	--	--

Card 3. For each active degree of freedom include a pair of Cards 2 and 3. This data is terminated by the next keyword ("*") card or when all six degrees of freedom have been specified.

FLCID	HLCID	C1	C2	DLE	GLCID		
-------	-------	----	----	-----	-------	--	--

Data Card Definitions:

Card 1	1	2	3	4	5	6	7	8
Variable	MID	RO						DOSPOT
Type	A	F						I

VARIABLE	DESCRIPTION
MID	Material identification. A unique number or label must be specified (see *PART).
RO	Mass density; see also volume in *SECTION_BEAM definition.
DOSPOT	<p>Activate thinning of tied shell elements when SPOTHIN > 0 on *CONTROL_CONTACT.</p> <p>EQ.0: Spot weld thinning is inactive for shells tied to discrete beams that use this material (default).</p> <p>EQ.1: Spot weld thinning is active for shells tied to discrete beams that use this material.</p>

Card 2	1	2	3	4	5	6	7	8
Variable	DOF	TYPE	K	D	CDF	TDF		
Type	I	I	F	F	F	F		

VARIABLE	DESCRIPTION
DOF	Active degree-of-freedom, a number between 1 and 6 inclusive. Each value of DOF can only be used once. The active degree-of-freedom is measured in the local coordinate system for the discrete beam element.
TYPE	<p>Material behavior:</p> <p>EQ.0: elastic (default)</p> <p>EQ.1: inelastic</p>
K	Elastic loading/unloading stiffness. This is required input for inelastic behavior.
D	Optional viscous damping coefficient
CDF	<p>Compressive displacement at failure. Input as a positive number. After failure, no forces are carried. This option does not apply to zero length springs.</p> <p>EQ.0.0: inactive</p>

VARIABLE	DESCRIPTION
TDF	Tensile displacement at failure. After failure, no forces are carried. EQ.0.0: inactive

Card 3	1	2	3	4	5	6	7	8
Variable	FLCID	HLCID	C1	C2	DLE	GLCID		
Type	F	F	F	F	F	I		

VARIABLE	DESCRIPTION
FLCID	<p>Load curve ID (see *DEFINE_CURVE).</p> <p>TYPE.EQ.0: this curve defines force or moment as a function of deflection for nonlinear elastic behavior.</p> <p>TYPE.EQ.1: this curve defines the yield force as a function of plastic deflection. If the abscissa of the first point of the curve is 0. the force magnitude is identical in tension and compression, that is, only the sign changes. If not, the yield stress in the compression is used when the spring force is negative. The plastic displacement increases monotonically in this implementation. The load curve is required input.</p>
HLCID	Optional load curve ID (see *DEFINE_CURVE) defining force as a function of relative velocity. If the origin of the curve is at (0,0), the force magnitude is identical for a given magnitude of the relative velocity, meaning only the sign changes.
C1	Damping coefficient
C2	Damping coefficient
DLE	Factor to scale time units
GLCID	Optional load curve ID (see *DEFINE_CURVE) defining a scale factor as a function of deflection for load curve ID, HLCID. If zero, a scale factor of unity is assumed.

Remarks:

1. **Elastic Behavior.** If TYPE = 0, elastic behavior is obtained. In this case, if the linear spring stiffness is used, the force, F , is given by:

$$F = K \times \Delta L + D \times \Delta \dot{L} .$$

But if the load curve ID is specified, the force is then given by:

$$F = K f(\Delta L) \left[1 + C1 \times \Delta \dot{L} + C2 \times \text{sgn}(\Delta \dot{L}) \ln \left(\max \left\{ 1, \frac{|\Delta \dot{L}|}{DLE} \right\} \right) \right] + D \times \Delta \dot{L} + g(\Delta L) h(\Delta \dot{L}) .$$

In these equations, ΔL is the change in length

$$\Delta L = \text{current length} - \text{initial length}$$

For the first three degrees of freedom the fields on Cards 2 and 3 have dimensions as shown below. Being angular in nature, the next three degrees of freedom involve moment instead of force and angle instead of length but are otherwise identical.

$$[K] = \begin{cases} \frac{[\text{force}]}{[\text{length}]} & \text{FLCID} = 0 \\ \text{unitless} & \text{FLCID} > 0 \end{cases}$$

$$[D] = \frac{[\text{force}]}{[\text{velocity}]} = \frac{[\text{force}][\text{time}]}{[\text{length}]}$$

$$[\text{FLCID}] = [\text{GLCID}] = ([\text{length}], [\text{force}])$$

$$[\text{HLCID}] = ([\text{velocity}], [\text{force}])$$

$$[C1] = \frac{[\text{time}]}{[\text{length}]}$$

$$[C2] = \text{unitless}$$

$$[DLE] = \frac{[\text{length}]}{[\text{time}]}$$

2. **Inelastic Behavior.** If TYPE = 1, inelastic behavior is obtained. A trial force is computed as:

$$F^T = F^n + K \times \Delta \dot{L}(\Delta t)$$

and the yield force is taken from the load curve:

$$F^Y = F_y(\Delta L^{\text{plastic}}) ,$$

where L^{plastic} is the plastic deflection, given by

$$\Delta L^{\text{plastic}} = \frac{F^T - F^Y}{S + K^{\text{max}}} .$$

The maximum elastic stiffness is $K^{\max} = \max(K, 2 \times S^{\max})$, where S is the slope of FLCID. The trial force is checked against the yield force to determine F :

$$F = \begin{cases} F^Y & \text{if } F^T > F^Y \\ F^T & \text{if } F^T \leq F^Y \end{cases}$$

The final force, which includes rate effects and damping, is given by:

$$F^{n+1} = F \times \left[1 + C1 \times \Delta\dot{L} + C2 \times \text{sgn}(\Delta\dot{L}) \ln \left(\max \left\{ 1, \frac{|\Delta\dot{L}|}{DLE} \right\} \right) \right] + D \times \Delta\dot{L} + g(\Delta L)h(\Delta\dot{L}) .$$

Unless the origin of the curve starts at (0,0), the negative part of the curve is used when the spring force is negative where the negative of the plastic displacement is used to interpolate, F_y . The positive part of the curve is used whenever the force is positive.

3. **Cross-Sectional Area.** The cross-sectional area is defined on the section card for the discrete beam elements, See *SECTION_BEAM. The square root of this area is used as the contact thickness offset if these elements are included in the contact treatment.
4. **Rotational Displacement.** Rotational displacement is measured in radians.

*MAT_SEISMIC_ISOLATOR

This is Material Type 197 for discrete beam elements. Sliding (pendulum) and elastomeric seismic isolation bearings can be modeled, applying bi-directional coupled plasticity theory. The hysteretic behavior was proposed by Wen [1976] and Park, Wen, and Ang [1986]. The sliding bearing behavior is recommended by Zayas, Low and Mahin [1990]. The algorithm used for implementation was presented by Nagarajaiah, Reinhorn, and Constantinou [1991]. Further options for tension-carrying friction bearings are as recommended by Roussis and Constantinou [2006]. Element formulation type 6 must be used. Local axes are defined on *SECTION_BEAM; the default is the global axis system. The local z-axis is expected to be vertical. On *SECTION_BEAM SCOOOR must be set to zero when using this material model, even if the element has non-zero initial length.

Card Summary:

Card 1. This card is required/

MID	RO	A	BETA	GAMMA	DISPY	STIFFV	ITYPE
-----	----	---	------	-------	-------	--------	-------

Card 2. This card is required.

PRELOAD	DAMP	MX1	MX2	MY1	MY2	CDE	IEXTRA
---------	------	-----	-----	-----	-----	-----	--------

Card 3. This card is used for ITYPE = 0, 2, or 5. Leave this card blank for all other settings of ITYPE.

FMAX	DELFL	AFRIC	RADX	RADY	RADB	STIFFL	STIFFTS
------	-------	-------	------	------	------	--------	---------

Card 4a. This card is included for ITYPE = 1 or 4.

FORCEY	ALPHA	STIFFT	DFAIL				
--------	-------	--------	-------	--	--	--	--

Card 4b. This card is included for ITYPE = 2.

				FMAXYC	FMAXXT	FMAXYT	YLOCK
--	--	--	--	--------	--------	--------	-------

Card 4c. This card is included for ITYPE = 3.

FORCEY	ALPHA						
--------	-------	--	--	--	--	--	--

Card 4d. This blank card is included for all other settings of ITYPE (0 or 5).

--	--	--	--	--	--	--	--

Card 5. This card is included for ITYPE = 3 only. Omit for other settings of ITYPE.

HTCORE	RCORE	TSHIM	ROLCL	ROSCS	THCST	YLE2	
--------	-------	-------	-------	-------	-------	------	--

Card 6. This card is included for ITYPE = 3 only. Omit for other settings of ITYPE.

PCRINI	DIAMB	FCAVO	CAVK	CAVTR	CAVA	PHIM	
--------	-------	-------	------	-------	------	------	--

Card 7. This card is included for ITYPE = 4 only. Omit for other settings of ITYPE.

BETA							
------	--	--	--	--	--	--	--

Card 8. This card is included for ITYPE = 5 only. Omit for other settings of ITYPE.

FYRIM	DFRIM						
-------	-------	--	--	--	--	--	--

Card 9. This card is included if and only if IEXTRA = 1.

KTHX	KTHY	KTHZ					
------	------	------	--	--	--	--	--

Data Card Definitions:

Card 1	1	2	3	4	5	6	7	8
Variable	MID	RO	A	BETA	GAMMA	DISPY	STIFFV	ITYPE
Type	A	F	F	F	F	F	F	I
Default	none	none	1.0	0.5	0.5	none	none	0.0

VARIABLE

DESCRIPTION

MID	Material identification. A unique number or label must be specified (see *PART).
RO	Mass density
A	Nondimensional variable - see below
GAMMA	Nondimensional variable - see below
BETA	Nondimensional variable - see below
DISPY	Yield displacement (length units - must be > 0.0)

VARIABLE	DESCRIPTION
----------	-------------

STIFFV Vertical stiffness (force/length units)

ITYPE Type:
 EQ.0: sliding (spherical or cylindrical)
 EQ.1: elastomeric
 EQ.2: sliding (two perpendicular curved beams)
 EQ.3: lead rubber bearing
 EQ.4: high damping rubber bearing
 EQ.5: sliding with rim failure

Card 2	1	2	3	4	5	6	7	8
Variable	PRELOAD	DAMP	MX1	MX2	MY1	MY2	CDE	IEXTRA
Type	F	F	F	F	F	F	F	I
Default	0.0	1.0	0.0	0.0	0.0	0.0	0.0	0

VARIABLE	DESCRIPTION
----------	-------------

PRELOAD Vertical preload not explicitly modeled (force units)

DAMP Damping ratio (nondimensional)

MX1, MX2 Moment factor at ends 1 and 2 in local *x*-direction

MY1, MY2 Moment factor at ends 1 and 2 in local *y*-direction

CDE Viscous damping coefficient (ITYPE = 1, 3 or 4)

IEXTRA If IEXTRA = 1, optional [Card 9](#) will be read

Sliding Isolator Card. This card is used for ITYPE = 0, 2, or 5. Leave this card *blank* for all other settings of ITYPE.

Card 3	1	2	3	4	5	6	7	8
Variable	FMAX	DELF	AFRIC	RADX	RADY	RADB	STIFFL	STIFFTS
Type	F	F	F	F	F	F	F	F
Default	0.0	0.0	0.0	10 ²⁰	10 ²⁰	10 ²⁰	STIFFV	0.0

VARIABLE**DESCRIPTION**

FMAX	Maximum friction coefficient (dynamic)
DELF	Difference between maximum friction and static friction coefficient
AFRIC	Velocity multiplier in sliding friction equation (time/length units)
RADX	Radius for sliding in local <i>x</i> direction
RADY	Radius for sliding in local <i>y</i> direction
RADB	Radius of retaining ring
STIFFL	Stiffness for lateral contact against the retaining ring
STIFFTS	Stiffness for tensile vertical response (default = 0)

This card is included only for ITYPE = 1 or 4.

Card 4a	1	2	3	4	5	6	7	8
Variable	FORCEY	ALPHA	STIFFT	DFAIL	FMAXYC	FMAXXT	FMAXYT	YLOCK
Type	F	F	F	F	F	F	F	F
Default	none	0.0	0.5 × STIFFV	10 ²⁰	FMAX	FMAX	FMAX	0.0

VARIABLE**DESCRIPTION**

FORCEY	Yield force
--------	-------------

VARIABLE	DESCRIPTION
ALPHA	Ratio of post-yielding stiffness to pre-yielding stiffness
STIFFT	Stiffness for tensile vertical response (elastomeric isolator)
DFAIL	Lateral displacement at which the isolator fails

This card is included only for ITYPE = 2.

Card 4b	1	2	3	4	5	6	7	8
Variable					FMAXYC	FMAXXT	FMAXYT	YLOCK
Type					F	F	F	F
Default					FMAX	FMAX	FMAX	0.0

VARIABLE	DESCRIPTION
FMAXYC	Max friction coefficient (dynamic) for local y -axis (compression)
FMAXXT	Max friction coefficient (dynamic) for local x -axis (tension)
FMAXYT	Max friction coefficient (dynamic) for local y -axis (tension)
YLOCK	Stiffness locking the local y -displacement (optional -single-axis sliding)

This card is included only for ITYPE = 3.

Card 4c	1	2	3	4	5	6	7	8
Variable	FORCEY	ALPHA						
Type	F	F						
Default	none	0.0						

VARIABLE	DESCRIPTION
FORCEY	Yield force

VARIABLE**DESCRIPTION**

ALPHA

Ratio of post-yielding stiffness to pre-yielding stiffness

Include this *blank* card for ITYPE = 0 or 5.

Card 4d	1	2	3	4	5	6	7	8
Variable								
Type								
Default								

Lead Rubber Bearing Card. This card is included for ITYPE = 3 only. Omit for other settings of ITYPE.

Card 5	1	2	3	4	5	6	7	8
Variable	HTCORE	RCORE	TSHIM	ROLCL	ROSCS	THCST	YLE2	
Type	F	F	F	F	F	F	F	
Default	none	none	none	none	none	none	none	

VARIABLE**DESCRIPTION**

HTCORE

Height of lead core (length units)

RCORE

Radius of lead core (length units)

TSHIM

Total thickness of shim plates (length units)

ROLCL

Mass density times specific heat capacity of lead (units: F.L⁻²T⁻¹)

ROLCS

Mass density times specific heat capacity of steel (units: F.L⁻²T⁻¹)

THCST

Thermal conductivity of steel (units: F.t⁻¹T⁻¹)

YLE2

 E_2 in temperature-dependent yield stress of lead (units: 1/Temperature)

Lead Rubber Bearing Card. This card is included for ITYPE = 3 only. Omit for other settings of ITYPE.

Card 6	1	2	3	4	5	6	7	8
Variable	PCRINI	DIAMB	FCAV0	CAVK	CAVTR	CAVA	PHIM	
Type	F	F	F	F	F	F	F	
Default	none	none	none	none	none	none	none	

VARIABLE**DESCRIPTION**

PCRINI	Buckling capacity (force units)
DIAMB	External diameter of bearing (length units)
FCAV0	Tensile capacity limited by cavitation (force units)
CAVK	Cavitation parameter (units 1/length)
TR	Total thickness of rubber (length units)
CAVA	Strength degradation parameter (dimensionless)
PHIM	Maximum cavitation damage index (dimensionless)

High Damping Rubber Bearing Yield Card. This card is included for ITYPE = 4 only. Omit for other settings of ITYPE.

Card 7	1	2	3	4	5	6	7	8
Variable	BETA							
Type	F							
Default	0.0							

VARIABLE**DESCRIPTION**

BETA	Quadratic factor for yield force
------	----------------------------------

Rim Failure Card. This card is included for ITYPE = 5 only. Omit for other settings of ITYPE.

Card 8	1	2	3	4	5	6	7	8
Variable	FYRIM	DFRIM						
Type	F	F						
Default	10 ²⁰	10 ²⁰						

VARIABLE**DESCRIPTION**

FYRIM

Radial force at failure of rim

DFRIM

Radial displacement of rim to failure after FYRIM is reached

Rotational Stiffness Card. Card 9 for IEXTRA = 1 only. Omit if IEXTRA=0.

Card 9	1	2	3	4	5	6	7	8
Variable	KTHX	KTHY	KTHZ					
Type	F	F	F					
Default	0	0	0					

VARIABLE**DESCRIPTION**

KTHX

Rotational stiffness in local x direction (moment per radian)

KTHY

Rotational stiffness in local y direction (moment per radian)

KTHZ

Rotational stiffness in local z direction (moment per radian)**Remarks:**

- Horizontal Behavior of the Isolator.** The horizontal behavior for all isolator types is governed by plastic history variables Z_x and Z_y that evolve according to equations given in the reference; A , $GAMMA$, $BETA$ and $DISPY_t$ are the input parameters for this. The intention is to provide smooth build-up, rotation and reversal of forces in response to bidirectional displacement histories in the

horizontal plane. The theoretical model has been correlated to experiments on seismic isolators.

2. **Sliding Surface for Sliding Isolator.** The RADX and RADY inputs for the sliding isolator are optional. If left blank, the sliding surface is assumed to be flat. A cylindrical surface is obtained by defining either RADX or RADY; a spherical surface can be defined by setting RADX = RADY. The effect of the curved surface is to add a restoring force proportional to the horizontal displacement from the center. As seen in elevation, the top of the isolator will follow a curved trajectory, lifting as it displaces away from the center.
3. **Vertical Behavior of the Isolator.** The vertical behavior for all types is linear elastic, but with different stiffnesses for tension and compression. By default, the tensile stiffness is zero for the sliding types. For the elastomeric type in the case of uplift, the tensile stiffness will be different from the compressive stiffness. For the sliding type, compression is treated as linear elastic, but no tension can be carried.
4. **Vertical Preload.** Vertical preload can be modeled either explicitly (for example, by defining gravity), or by using the PRELOAD input. PRELOAD does not lead to any application of vertical force to the model. It is added to the compression in the element before calculating the friction force and tensile/compressive vertical behavior.
5. **Overview of ITYPE.** Various settings of ITYPE are described as follows.
 - a) ITYPE = 0 is used to model a single (spherical) pendulum bearing. Triple pendulum bearings can be modelled using three of these elements in series, following the method described by Fenz and Constantinou 2008.
 - b) ITYPE = 2 is intended to model uplift-prevention sliding isolators that consist of two perpendicular curved beams joined by a connector that can slide in slots on both beams. The beams are aligned in the local x and y axes, respectively. The vertical displacement is the sum of the displacements induced by the respective curvatures and slider displacements along the two beams. Single-axis sliding is obtained by using YLOCK to lock the local y displacement. To resist uplift, STIFFTS must be defined (recommended value: same as STIFFV). This isolator type allows for different friction coefficients on each beam as well as different values in tension and compression. The total friction, taking into account sliding velocity and the friction history functions, is first calculated using FMAX which applies to the local x -axis when in compression, and then scaled as necessary, such as by FMAXXT/FMAX (for the local x -axis when in tension) and by FMAXYC/FMAX or FMAXYT/FMAX for the y -axis as appropriate. For this reason, FMAX should not be zero.

- c) ITYPE = 3 is used to model Lead Rubber Bearings (LRB), made of rubber with a lead core. Phenomenological models following Kumar et al. (2014) are incorporated to simulate the following salient behavior:
- i) The properties of the lead core may degrade in the short-term because of substantial internal heat generation from cyclic deformation.
 - ii) Under larger lateral deformation, the rubber may experience net tension which will affect the compression and tension stiffness, and lead to potential vertical instability.
 - iii) Cavitation may happen when the bearing is under excessive tension, resulting in permanent damage in the tensile capacity.
- d) ITYPE = 4 is used to model higher damping rubber bearings. It differs from elastomeric bearing (ITYPE = 1) in that the time-varying yield force is a function of resultant horizontal displacement, governed by:

$$\text{Yield force} = \text{FORCEY} \left(1 + \text{BETA} \left(\frac{dx^2 + dy^2}{\text{DISPY}^2} \right) \right).$$

Here dx and dy are the displacements in the local x and y directions.

- e) ITYPE = 5 is the same as ITYPE = 0 (spherical sliding bearing), except for the additional capability of yielding and failure of the rim, also called the retaining ring. The rim is intended to prevent the radial displacement of the slider exceeding RADB, but if sufficient radial force is applied, the rim can yield and then fail, leading to the slider falling off the supporting surface. When the rim fails, the isolator element is deleted.
6. **Damping.** DAMP is the fraction of critical damping for free vertical vibration of the isolator, based on the mass of the isolator (including any attached lumped masses) and its vertical stiffness. The viscosity is reduced automatically if it would otherwise infringe numerical stability. Damping is generally recommended:
- a) Oscillations in the vertical force have a direct effect on friction forces in sliding isolators.
 - b) For isolators with curved surfaces, vertical oscillations can be excited as the isolator slides up and down the curved surface.

It may occasionally be necessary to increase DAMP if these oscillations become significant.

7. **Rotational Stiffness.** By default, this element has no rotational stiffness - a pin joint is assumed. However, if required, “offset moments” can be generated according to the vertical load multiplied by the lateral displacement of the isolator. This is invoked using MX1, MX2, MY1, MY2. The moment *about* the local *x*-axis (meaning the moment that is dependent on lateral displacement in the local *y*-direction) is reacted on nodes 1 and 2 of the element in the proportions MX1 and MX2, respectively. Similarly, moments about the local *y*-axis are reacted in the proportions MY1 and MY2. These inputs effectively determine the location of the pin joint.

For example, consider an isolator installed between the top of the foundation of a building (Node 1 of the isolator element) and the base of a column of the superstructure (Node 2 of the isolator element). To model a pin at the base of the column and react the offset moment on the foundation, set MX1 = MY1 = 1.0 and MX2 = MY2 = 0.0. For the same model, MX1 = MY1 = 0.0 and MX2 = MY2 = 1.0 would imply a pin at the top of the foundation - all the moment is transferred to the column. Some isolator designs have the pin at the bottom for moments about one horizontal axis, and at the top for the other axis - these can be modeled by setting MX1 = MY2 = 1.0 and MX2 = MY1 = 0.0. MX1, MX2, MY1 and MY2 are all expected to be greater than or equal to 0 and less than or equal to 1. Also, if MX1 and MX2 are not both zero, then MX1 + MX2 is expected to equal 1.0, and similarly for MY1 and MY2. However, no error checks are performed to ensure this.

Optionally, rotational stiffnesses that resist rotation of Node 2 relative to Node 1 may be defined on [Card 9](#). These moments are applied equal and opposite on Nodes 1 and 2, irrespective of the settings of MX1, MX2, MY1 and MY2.

8. **Density.** Density should be set to a reasonable value, say 2000 to 8000 kg/m³. The element mass will be calculated as density × volume (volume is entered on *SECTION_BEAM).
9. **SECTION_BEAM Input.** Note on values for *SECTION_BEAM:
 - a) Set ELFORM to 6 (discrete beam).
 - b) VOL (the element volume) might typically be set to 0.1 m³.
 - c) INER always needs to be non-zero. It will influence the solution only when the element has rotational stiffness, that is, when any of MX1, MX2, MY1, MY2, KTHX, KTHY or KTHZ are non-zero. A reasonable value might be 10-20 kg-m².
 - d) CID can be left blank if the isolator is aligned in the global coordinate system, otherwise a coordinate system should be referenced.

- e) By default, the isolator will be assumed to rotate with the average rotation of its two nodes. If the base of the column rotates slightly the isolator will no longer be perfectly horizontal: this can cause unexpected vertical displacements coupled with the horizontal motion. To avoid this, rotation of the local axes of the isolator can be eliminated by setting RRCON, SRCON, and TRCON to 1.0. This does not introduce any rotational restraint to the model, it only prevents the orientation of the isolator from changing as the model deforms.
 - f) SCOOR must be set to zero.
 - g) All other parameters on *SECTION_BEAM can be left blank.
10. **Post-Processing Note.** As with other discrete beam material models, the force described in some post-processors as “Axial” is really the force in the local x -direction; “Y-Shear” is really the force in the local y -direction; and “Z-Shear” is really the force in the local z -direction.

*MAT_JOINTED_ROCK

This is Material Type 198. Joints (planes of weakness) are assumed to exist throughout the material at a spacing small enough to be considered ubiquitous. The planes are assumed to lie at constant orientations defined on this material card. Up to three planes can be defined for each material. The base material is like *MAT_DRUCKER_PRAGER (*MAT_193). Input parameters for the base material are defined on Cards 1 through 3, while the joint planes are defined using Card 4. See *MAT_MOHR_COULOMB (*MAT_173) for a preferred alternative to this material model.

Card Summary:

Card 1. This card is required.

MID	RO	GMOD	RNU	RKF	PHI	CVAL	PSI
-----	----	------	-----	-----	-----	------	-----

Card 2. This card is required.

STR_LIM	NPLANES	ELASTIC	LCCPDR	LCCPT	LCCJDR	LCCJT	LCSFAC
---------	---------	---------	--------	-------	--------	-------	--------

Card 3. This card is required.

GMODDP	PHIDP	CVALDP	PSIDP	GMODGR	PHIGR	CVALGR	PSIGR
--------	-------	--------	-------	--------	-------	--------	-------

Card 4. Include an instance of this card for each plane. Up to three planes may be defined.

DIP	STRIKE	CPLANE	FRPLANE	TPLANE	SHRMAX	LOCAL	
-----	--------	--------	---------	--------	--------	-------	--

Data Card Definitions:

Card 1	1	2	3	4	5	6	7	8
Variable	MID	RO	GMOD	RNU	RKF	PHI	CVAL	PSI
Type	A	F	F	F	F	F	F	F
Default	none	none	none	none	1.0	none	none	0.0

VARIABLE	DESCRIPTION
MID	Material identification. A unique number or label must be specified (see *PART).
RO	Mass density
GMOD	Elastic shear modulus
RNU	Poisson's ratio
RKF	Failure surface shape parameter, see Remark 5 .
PHI	Angle of friction (radians)
CVAL	Cohesion value (shear strength at zero normal stress)
PSI	Dilation angle (radians)

Card 2	1	2	3	4	5	6	7	8
Variable	STR_LIM	NPLANES	ELASTIC	LCCPDR	LCCPT	LCCJDR	LCCJT	LCSFAC
Type	F	I	I	I	I	I	I	I
Default	0.005	0	0	0	0	0	0	0

VARIABLE	DESCRIPTION
STR_LIM	Minimum shear strength of material is given by STR_LIM × CVAL (see Remark 6)
NPLANES	Number of joint planes (maximum of 3)
ELASTIC	Behavior of base material (see Remark 3): EQ.0: Nonlinear using all parameters on Cards 1 through 3 EQ.1: Linear elastic; only the joint planes are nonlinear
LCCPDR	Load curve for extra cohesion for base material (dynamic relaxation) as a function of time. See Remark 8 .
LCCPT	Load curve for extra cohesion for base material (transient) as a function of time. See Remark 8 .

VARIABLE	DESCRIPTION
LCCJDR	Load curve for extra cohesion for joints (dynamic relaxation) as a function of time. See Remark 8 .
LCCJT	Load curve for extra cohesion for joints (transient) as a function of time. See Remark 8 .
LCSFAC	Load curve giving a factor on strength as a function of time (see Remark 9).

Card 3	1	2	3	4	5	6	7	8
Variable	GMODDP	PHIDP	CVALDP	PSIDP	GMODGR	PHIGR	CVALGR	PSIGR
Type	F	F	F	F	F	F	F	F
Default	0.0	0.0	0.0	0.0	0.0	0.0	0.0	0.0
Remark	4	4	4	4	4	4	4	4

VARIABLE	DESCRIPTION
GMODDP	Z-coordinate at which GMOD is correct
PHIDP	Z-coordinate at which PHI is correct
CVALDP	Z-coordinate at which CVAL is correct
PSIDP	Z-coordinate at which PSI is correct
GMODGR	Gradient of GMOD as a function of Z-coordinate (usually negative)
PHIGR	Gradient of PHI as a function of Z-coordinate
CVALGR	Gradient of CVAL as a function of Z-coordinate (usually negative)
PSIGR	Gradient of PSI as a function of Z-coordinate

Repeat Card 4 for each plane (maximum of 3 planes):

Card 4	1	2	3	4	5	6	7	8
Variable	DIP	STRIKE	CPLANE	FRPLANE	TPLANE	SHRMAX	LOCAL	
Type	F	F	F	F	F	F	F	
Default	0.0	0.0	0.0	0.0	0.0	1.e20	0.0	

VARIABLE**DESCRIPTION**

DIP	Angle of the plane in degrees below the horizontal
STRIKE	Plan view angle (degrees) of downhill vector drawn on the plane
CPLANE	Cohesion for shear behavior on plane
FRPLANE	Friction angle for shear behavior on plane (degrees)
TPLANE	Tensile strength across plane (generally zero or very small)
SHRMAX	Max shear stress on plane (upper limit, independent of compression)
LOCAL	Axes (see Remark 10) EQ.0: DIP and STRIKE are with respect to the global axes. EQ.1: DIP and STRIKE are with respect to the local element axes.

Remarks:

- Joint Plane Orientations.** The joint plane orientations are defined by the angle of a “downhill vector” drawn on the plane, that is, the vector is oriented within the plane to obtain the maximum possible downhill angle. DIP is the angle of this line below the horizontal. STRIKE is the plan-view angle of the line (pointing downhill) measured clockwise from the global Y-axis about the global Z-axis. Note that DIP and STRIKE can also be with respect to the local element axes. See [Remark 10](#) for details.
- Rigid Body Motion.** The joint planes rotate with the rigid body motion of the elements, irrespective of whether their initial definitions are in the global or local axis system.

3. **Elastic Only Behavior.** The full facilities of the modified Drucker Prager model for the base material can be used – see description of material type 193. Alternatively, to speed up the calculation, the ELASTIC flag can be set to 1, in which case the yield surface will not be considered and only RO, GMOD, RNU, GMODDP, GMODGR and the joint planes will be used.
4. **Model Orientation.** This material type requires that the model is oriented such that the Z-axis is defined in the upward direction. The key parameters are defined such that they may vary with depth (i.e. the Z-axis), see Card 3. If Card 3 is left blank, the material properties do not vary with depth.
5. **Shape Factor RKF.** The shape factor for a typical soil would be around 0.8. Values less than 0.75 should not be used.
6. **STR_LIM.** If STR_LIM is set to less than 0.005, the value is reset to 0.005.
7. **Correction to Drucker Prager Model.** A correction has been introduced into the Drucker Prager model, such that the yield surface never infringes the Mohr-Coulomb criterion. Thus, the model does not give the same results as a “pure” Drucker Prager model.
8. **Load Curves giving Extra Cohesion.** The load curves LCCPDR, LCCPT, LC-CJDR, and LCCJT allow additional cohesion to be specified as a function of time. This cohesion is in addition to that specified in the material parameters. This feature is intended for use during the initial stages of an analysis to allow application of gravity or other loads without cracking or yielding, and for the cracking or yielding then to be introduced in a controlled manner. This is done by specifying extra cohesion that exceeds the expected stresses initially, then declining to zero. If no curves are specified, no extra cohesion is applied.
9. **LCSFAC.** The load curve giving a factor on strength applies simultaneously to the cohesion and tan PHI of the base material and all joints. This feature is intended for reducing the strength of the material gradually to explore factors of safety. If no curve is present, a constant factor of 1 is assumed. Values much greater than 1.0 may cause problems with stability.
10. **Masonry and Joint Planes.** Joint planes are generally defined in the global axis system if they are taken from survey data, and the material represents rock. For this case, set LOCAL = 0. In other cases, it may be more convenient to define the joint plane angles, DIP and STRIKE, relative to the element local axis system (to do this, set LOCAL = 1). For example, this material model can be used to represent masonry with the weak planes representing the mortar joint. In this situation, these joints may be parallel to the local element axes throughout the mesh.

The choice of defining the joint angles relative to global versus local coordinates is available only for solid elements. For thick shell elements (*ELEMENT_-

TSHELL), DIP and STRIKE are always relative to the element local axis and the setting of LOCAL is ignored.

11. **Extra History Variables.** Extra history variables may be plotted (see NEIPH on *DATABASE_EXTENT_BINARY). They are described in the following table:

History Variable #	Description
1	Mobilized strength fraction for base material
2	At-rest coefficient (defined as horizontal stress divided by vertical stress, where "horizontal stress" is the average of the stresses in the global X and Y directions, and "vertical stress" is in the global Z direction).
4 – 6	Crack opening strains for planes 1 through 3
7 – 9	Crack accumulated engineering shear strain for planes 1 through 3
10 – 12	Current shear utilization for planes 1 through 3
13 – 15	Maximum shear utilization to date for planes 1 through 3

*MAT_BARLAT_YLD2004

This is Material Type 199. This model was developed by Aretz and Barlat [2004] and Barlat et al. [2005]. It incorporates a yield criterion called Barlat 2004-18p, where up to 18 material parameters are used to define anisotropy for a full 3D stress state. This model is currently available for solid elements and thick shell formulations 3, 5 and 7.

Card 1	1	2	3	4	5	6	7	8
Variable	MID	R0	E	PR				
Type	A	F	F	F				

Card 2	1	2	3	4	5	6	7	8
Variable	CP12	CP13	CP21	CP23	CP31	CP32		
Type	F	F	F	F	F	F		

Card 3	1	2	3	4	5	6	7	8
Variable	CPP12	CPP13	CPP21	CPP23	CPP31	CPP32		
Type	F	F	F	F	F	F		

Card 4	1	2	3	4	5	6	7	8
Variable	CP44	CP55	CP66	CPP44	CPP55	CPP66		
Type	F	F	F	F	F	F		

Card 5	1	2	3	4	5	6	7	8
Variable	AOPT	A	LCSS					
Type	F	F	I					

Card 6	1	2	3	4	5	6	7	8
Variable	XP	YP	ZP	A1	A2	A3	MACF	
Type	F	F	F	F	F	F	I	

Card 7	1	2	3	4	5	6	7	8
Variable	V1	V2	V3	D1	D2	D3	BETA	
Type	F	F	F	F	F	F	F	

VARIABLE

DESCRIPTION

MID	Material identification. A unique number or label must be specified (see *PART).
RO	Mass density
E	Young's modulus LT.0.0: -E is either a load curve ID for Young's modulus as a function of plastic strain or a table ID for Young's modulus as a function of plastic strain and temperature.
PR	Poisson's ratio
CP _{ij}	9 coefficients c'_{ij} of the first linear transformation matrix C'
CPP _{ij}	9 coefficients c''_{ij} of the second linear transformation matrix C''
AOPT	Material axes option (see MAT_OPTIONTROPIC_ELASTIC, particularly the Material Directions section, for details): EQ.0.0: Locally orthotropic with material axes determined by element nodes 1, 2, and 4, as with *DEFINE_COORDINATE_NODES. EQ.2.0: Globally orthotropic with material axes determined by vectors defined below, as with *DEFINE_COORDINATE_VECTOR

VARIABLE	DESCRIPTION
	<p>EQ.3.0: Locally orthotropic material axes determined by a vector \mathbf{v} and the normal vector to the plane of the element. The plane of a solid element is the midsurface between the inner surface and outer surface defined by the first four nodes and the last four nodes of the connectivity of the element, respectively. Thus, for solid elements, AOPT = 3 is only available for hexahedrons. \mathbf{a} is determined by taking the cross product of \mathbf{v} with the normal vector, \mathbf{b} is determined by taking the cross product of the normal vector with \mathbf{a}, and \mathbf{c} is the normal vector. Then \mathbf{a} and \mathbf{b} are rotated about \mathbf{c} by an angle BETA. BETA may be set in the keyword input for the element or in the input for this keyword. Note that for solids, the material axes may be switched depending on the choice of MACF. The switch may occur before or after applying BETA depending on the value of MACF.</p> <p>EQ.4.0: Locally orthotropic in a cylindrical coordinate system with the material axes determined by a vector \mathbf{v}, and an originating point, P, which define the centerline axis. This option is for solid elements only.</p> <p>LT.0.0: The absolute value of AOPT is a coordinate system ID number (CID on *DEFINE_COORDINATE_OPTION).</p>
A	Flow potential exponent a
LCSS	<p>Load curve ID or table ID for (isotropic) hardening:</p> <p>GT.0: If LCSS is a load curve, then yield stress $\bar{\sigma}$ is a function of plastic strain. If LCSS is a table, then yield stress $\bar{\sigma}$ is a function of plastic strain and plastic strain rate.</p> <p>LT.0: If -LCSS is a load curve, then yield stress $\bar{\sigma}$ is a function of plastic strain. If -LCSS is a table, then yield stress $\bar{\sigma}$ is a function of plastic strain and temperature.</p>
XP YP ZP	Define coordinates of point P for AOPT = 1 and 4
A1, A2, A3	Components of vector \mathbf{a} for AOPT = 2
MACF	<p>Material axes change flag for solid elements:</p> <p>EQ.-4: Switch material axes b and c before BETA rotation</p> <p>EQ.-3: Switch material axes a and c before BETA rotation</p>

VARIABLE	DESCRIPTION
	EQ.-2: Switch material axes <i>a</i> and <i>b</i> before BETA rotation
	EQ.1: No change, default
	EQ.2: Switch material axes <i>a</i> and <i>b</i> after BETA rotation
	EQ.3: Switch material axes <i>a</i> and <i>c</i> after BETA rotation
	EQ.4: Switch material axes <i>b</i> and <i>c</i> after BETA rotation
	<p>Figure M2-2 indicates when LS-DYNA applies MACF during the process to obtain the final material axes. If BETA on *ELEMENT_SOLID_{OPTION} is defined, then that BETA is used for the rotation for all AOPT options. Otherwise, if AOPT = 3, the BETA input on Card 7 rotates the axes. For all other values of AOPT, the material axes will be switched as specified by MACF, but no BETA rotation will be performed.</p>
V1, V2, V3	Components of vector v for AOPT = 3
D1, D2, D3	Components of vector d for AOPT = 2
BETA	Material angle in degrees for AOPT = 3. It may be overridden on the element card; see *ELEMENT_SOLID_ORTHO and *ELEMENT_TSHELL_BETA.

Remarks:

The 3D yield condition for this material can be written as (see Barlat et al. [2005])

$$\begin{aligned}
 \phi &= \phi(\tilde{\mathbf{S}}', \tilde{\mathbf{S}}'') \\
 &= |\tilde{S}'_1 - \tilde{S}''_1|^a + |\tilde{S}'_1 - \tilde{S}''_2|^a + |\tilde{S}'_1 - \tilde{S}''_3|^a + |\tilde{S}'_2 - \tilde{S}''_1|^a + |\tilde{S}'_2 - \tilde{S}''_2|^a \\
 &\quad + |\tilde{S}'_2 - \tilde{S}''_3|^a + |\tilde{S}'_3 - \tilde{S}''_1|^a + |\tilde{S}'_3 - \tilde{S}''_2|^a + |\tilde{S}'_3 - \tilde{S}''_3|^a \\
 &= 4\bar{\sigma}^a
 \end{aligned}$$

Here \tilde{S}'_i and \tilde{S}''_i ($i = 1,2,3$) are the 6 principal values, a is the flow potential exponent, and $\bar{\sigma}$ is the effective uniaxial yield stress (defined with LCSS). The diagonal tensors $\tilde{\mathbf{S}}' = \text{diag}(\tilde{S}'_1, \tilde{S}'_2, \tilde{S}'_3)$ and $\tilde{\mathbf{S}}'' = \text{diag}(\tilde{S}''_1, \tilde{S}''_2, \tilde{S}''_3)$ contain the principal values of $\tilde{\mathbf{s}}'$ and $\tilde{\mathbf{s}}''$. $\tilde{\mathbf{s}}'$ and $\tilde{\mathbf{s}}''$ result from two linear transformations of the deviatoric portion of the Cauchy stress, **s**:

$$\begin{aligned}
 \tilde{\mathbf{s}}' &= \mathbf{C}'\mathbf{s} \\
 \tilde{\mathbf{s}}'' &= \mathbf{C}''\mathbf{s}
 \end{aligned}$$

C' and C'' have the following form:

$$C' = \begin{bmatrix} 0 & -c'_{12} & -c'_{13} & 0 & 0 & 0 \\ -c'_{21} & 0 & -c'_{23} & 0 & 0 & 0 \\ -c'_{31} & -c'_{32} & 0 & 0 & 0 & 0 \\ 0 & 0 & 0 & c'_{44} & 0 & 0 \\ 0 & 0 & 0 & 0 & c'_{55} & 0 \\ 0 & 0 & 0 & 0 & 0 & c'_{66} \end{bmatrix}$$

$$C'' = \begin{bmatrix} 0 & -c''_{12} & -c''_{13} & 0 & 0 & 0 \\ -c''_{21} & 0 & -c''_{23} & 0 & 0 & 0 \\ -c''_{31} & -c''_{32} & 0 & 0 & 0 & 0 \\ 0 & 0 & 0 & c''_{44} & 0 & 0 \\ 0 & 0 & 0 & 0 & c''_{55} & 0 \\ 0 & 0 & 0 & 0 & 0 & c''_{66} \end{bmatrix}$$

Each transformation matrix requires 9 coefficients that must be defined on Cards 2, 3, and 4 of this material model input. For identification of all 18 coefficients, uniaxial tests in several directions, biaxial tests, and crystal plasticity models (for out-of-plane properties) are needed. See Barlat et al. [2005] for more details and examples for parameters sets.

Note that the sequence of stress tensor components in LS-DYNA is as follows

$$s = \begin{bmatrix} s_{xx} \\ s_{yy} \\ s_{zz} \\ s_{xy} \\ s_{yz} \\ s_{zx} \end{bmatrix}$$

meaning matrix entry "44" is linked to stress component "xy", "55" belongs to "yz", and "66" refers to "zx". If compared to the paper from Barlat et al. [2005] that means the following relations hold (each equation: LS-DYNA parameters on the left, Barlat coefficients on the right):

$$CP44 = c'_{66} \quad CP55 = c'_{44} \quad CP66 = c'_{55}$$

$$CPP44 = c''_{66} \quad CPP55 = c''_{44} \quad CPP66 = c''_{55}$$

For example, the following input would correspond to the parameters in Table 2 of that paper for 6111-T4 aluminum alloy:

```
*MAT_BARLAT_YLD2004
...
$   CP12      CP13      CP21      CP23      CP31      CP32
  1.241024  1.078271  1.216463  1.223867  1.093105  0.889161
$   CPP12     CPP13     CPP21     CPP23     CPP31     CPP32
  0.775366  0.922743  0.765487  0.793356  0.918689  1.027625
$   CP44      CP55      CP66      CPP44     CPP55     CPP66
  1.349094  0.501909  0.557173  0.589787  1.115833  1.112273
...
```

***MAT_STEEL_EC3**

This is Material Type 202. Tables and formulae from Eurocode 3 are used to derive the mechanical properties and their variation with temperature, although these can be overridden by user-defined curves. It is currently available only for Hughes-Liu beam elements. This material model is intended for modelling structural steel in fires.

Card 1	1	2	3	4	5	6	7	8
Variable	MID	RO	E	PR	SIGY			
Type	A	F	F	F	F			
Default	none	none	none	none	none			

Card 2	1	2	3	4	5	6	7	8
Variable	LC_E	LC_PR	LC_AL	TBL_SS	LC_FS			
Type	F	F	F	F	F			
Default	0.0	0.0	0.0	0.0	0.0			

Card 3 *must* be included but left blank.

Card 3	1	2	3	4	5	6	7	8
Variable								
Type								
Default								

VARIABLE**DESCRIPTION**

MID	Material identification. A unique number or label must be specified (see *PART).
RO	Mass density

VARIABLE	DESCRIPTION
E	Young's modulus – a reasonable value must be provided even if LC_E is also input. See Remark 2 .
PR	Poisson's ratio
SIGY	Initial yield stress, σ_{y0}
LC_E	Optional load curve ID giving Young's modulus as a function of temperature (overrides E and factors from EC3)
LC_PR	Optional load curve ID giving Poisson's ratio as a function of temperature (overrides PR)
LC_AL	Optional load curve ID giving alpha as a function of temperature (over-rides thermal expansion data from EC3)
TBL_SS	Optional table ID containing stress-strain curves at different temperatures (overrides curves from EC3)
LC_FS	Optional load curve ID giving failure strain as a function of temperature

Remarks:

1. **Eurocode 3 and Required Input.** By default, only E, PR and SIGY must be defined. The Young's Modulus, E , will be scaled by a factor which is a function of temperature as specified in EC3. The factor is 1.0 at low temperature. Eurocode 3 (EC3) Section 3.2 specifies the stress-strain behaviour of carbon steels at temperatures between 20°C and 1200°C. The stress-strain curves given in EC3 are scaled within the material model such that the maximum stress at low temperatures is SIGY (see Figure below). By default, the thermal expansion coefficient as a function of temperature will be as specified in EC3 Section 3.4.1.1.
2. **Optional Input.** LC_E, LC_PR and LC_AL are optional; they should have temperature on the x -axis and the material property on the y -axis, with the points in order of increasing temperature. If defined (that is, nonzero), they over-ride E, PR, and the relationships from EC3. However, a reasonable value for E should always be included, since these values will be used for purposes such as contact stiffness calculation.

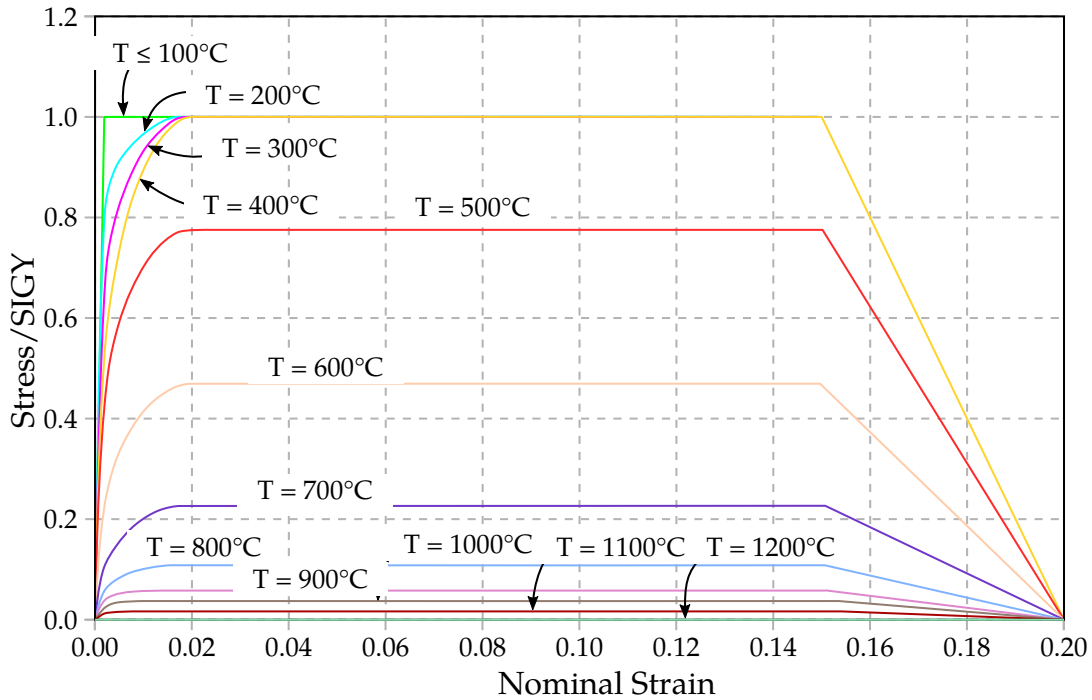

Figure M202-1. Stress-Strain Curves at various temperatures

TBL_SS is also optional. It overrides SIGY and the stress-strain relationships from EC3. If present, TBL_SS must be the ID of a *DEFINE_TABLE. The field VALUE on the *DEFINE_TABLE should contain the temperature at which each stress-strain curve is applicable; the temperatures should be in ascending order. The curves that follow the temperature values have plastic strain on the x-axis and yield stress on the y-axis as per other LS-DYNA elasto-plastic material models. As with all instances of *DEFINE TABLE, the curves containing the stress-strain data must immediately follow the *DEFINE_TABLE input data and must be in the correct order (that is, the same order as the temperatures).

3. **Temperature.** Temperature can be defined by any of the *LOAD_THERMAL methods. The temperature does not have to start at zero: the initial temperature will be taken as a reference temperature for each element, so non-zero initial temperatures will not cause thermal shock effects.
4. **Extra History Variables.** Temperature is output by this material model as Extra History Variable 1. This can be useful for checking the input in cases where temperature varies across the different integration points, as is the case with *LOAD_THERMAL_VARIABLE_BEAM

***MAT_HYSTERETIC_REINFORCEMENT**

This is Material Type 203 in LS-DYNA. It is intended as an alternative reinforcement model for layered reinforced concrete shell or beam elements, for use in seismic analysis where the nonlinear hysteretic behaviour of the reinforcement is important. *PART_COMPOSITE or *INTEGRATION_BEAM should be used to define some integration points as a part made of *MAT_HYSTERETIC_REINFORCEMENT, while other integration points have concrete properties using *MAT_CONCRETE_EC2. When using beam elements, ELFORM = 1 is required.

Card 1	1	2	3	4	5	6	7	8
Variable	MID	R0	YM	PR	SIGY	LAMDA	SBUCK	POWER
Type	I	F	F	F	F	F	F	F
Default	none	0.0	0.0	0.0	0.0	0.0	SIGY	0.5

Card 2	1	2	3	4	5	6	7	
Variable	FRACX	FRACY	LCTEN	LCCOMP	AOPT	EBU	DOWNSL	
Type	F	F	F	F	F	F	F	
Default	0.0	0.0	0.0	0.0	0.0	0.0	0.1	

Card 3	1	2	3	4	5	6	7	
Variable	DBAR	FCDOW	LCHARD	UNITC	UNITL			
Type	F	F	F	F	F			
Default	0.0	0.0	0.0	1.0	1.0			

Card 4	1	2	3	4	5	6	7	8
Variable	EPDAM1	EPDAM2	DRESID					
Type	F	F	F					
Default	0.0	0.0	0.0					

Additional Card for AOPT \neq 0.

Card 5	1	2	3	4	5	6	7	8
Variable	XP	YP	ZP	A1	A2	A3		
Type	F	F	F	F	F	F		
Default	0.0	0.0	0.0	0.0	0.0	0.0		

Additional Card for AOPT \neq 0.

Card 6	1	2	3	4	5	6	7	8
Variable	V1	V2	V3	D1	D2	D3	BETA	
Type	F	F	F	F	F	F	F	
Default	0.0	0.0	0.0	0.0	0.0	0.0	0.0	

VARIABLE**DESCRIPTION**

MID	Material identification. A unique number has to be chosen.
RO	Mass density.
YM	Young's Modulus
PR	Poisson's Ratio
SIGY	Yield stress

VARIABLE	DESCRIPTION
LAMDA	Slenderness ratio
SBUCK	Initial buckling stress (should be positive)
POWER	Power law for Bauschinger effect (non-dimensional)
FRACX	Fraction of reinforcement at this integration point in local x direction
FRACY	Fraction of reinforcement at this integration point in local y direction
LCTEN	Optional curve providing the factor on SIGY versus plastic strain (tension)
LCCOMP	Optional curve providing the factor on SBUCK versus plastic strain (compression)
AOPT	Option for local axis alignment – see material type 2
EBU	Optional buckling strain (if defined, overrides LAMBDA)
DOWNSL	Initial down-slope of buckling curve as a fraction of YM (dimensionless)
DBAR	Reinforcement bar diameter used for dowel action. See remarks.
FCDOW	Concrete compressive strength used for dowel action. See notes. This field has units of stress
LCHARD	Characteristic length for dowel action (length units)
UNITC	Factor to convert model stress units to MPa, e.g. if model units are Newtons and meters, $UNITC = 10^{-6}$, $[UNITC] = 1/[STRESS]$.
UNITL	Factor to convert model length units to millimeters, e.g. if model units are meters, $UNITL = 1000$, $[UNITL] = 1/[LENGTH]$.
EPDAM1	Accumulated plastic strain at which hysteretic damage begins
EPDAM2	Accumulated plastic strain at which hysteretic damage is complete
DRESID	Residual factor remaining after hysteretic damage
XP, YP, ZP	Coordinates of point \mathbf{p} for AOPT = 1 and 4 (see MAT 2)

VARIABLE	DESCRIPTION
A1, A2, A3	Components of vector a for AOPT = 2 (see MAT 2)
V1, V2, V3	Components of vector v for AOPT = 3 and 4 (see MAT 2)
D1, D2, D3	Components of vector d for AOPT = 2 (see MAT 2)
BETA	Angle for AOPT = 3 (see MAT 2)

Remarks:

Reinforcement is treated as bars, acting independently in the local material x and y directions. By default, the local material x -axis is the element x -axis (parallel to the line from Node 1 to Node 2), but this may be overridden using AOPT or Element Beta angles.

For shell elements, the reinforced concrete section should be defined using *PART_COMPOSITE with some integration points being reinforcement (referencing a Material ID using this material model) and others being concrete (using for example *MAT_CONCRETE_EC2). By default, shear strains in the local xy and yz and zx directions are unresisted by this material model so it should not be used alone (without concrete). The area fractions of reinforcement in the local x and y directions at each integration point are given by the thickness fraction of the integration point in the *PART_COMPOSITE definition times the fractions FRACX and FRACY on Card 2 above.

For beam elements, *INTEGRATION_BEAM is used to define the material of which each integration point is made (e.g. reinforcement or concrete). Due to a limitation of *INTEGRATION_BEAM, this material model can be paired only with *MAT_CONCRETE_EC2 within the same *INTEGRATION_BEAM.

The tensile response is elastic perfectly plastic, using yield stress SIGY. Optionally, load curves may be used to describe the stress-strain response in tension (LCTEN) and compression (LCCOMP). Either, neither or both curves may be defined. If present, LCTEN overrides the perfectly-plastic tensile response, and LCCOMP overrides the buckling curve. The tensile and compressive plastic strains are considered independent of each other.

Bar buckling may be defined either using the slenderness ratio LAMDA, or by setting the initial buckling strain EBU and down-slope DOWNSL. If neither are defined, the bars simply yield in compression. If both are defined, the buckling behaviour defined by EBU and DOWNSL overrides LAMDA.

The slenderness ratio LAMDA determines buckling behaviour and is defined as,

$$\frac{kL}{r'}$$

Where, k depends on end conditions, and

L = unsupported length of reinforcement bars

r = radius of gyration which for round bars is equal to (bar radius)/2.

It is expected that users will determine LAMDA accounting for the expected crack spacing.

The alternative buckling behaviour defined by EBU and DOWNSL is shown below.

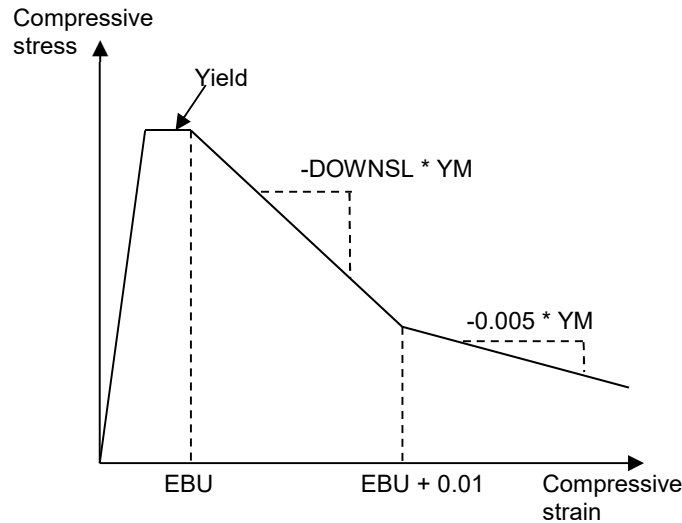

Reloading after change of load direction follows a Bauschinger-type curve, leading to the hysteresis response shown below:

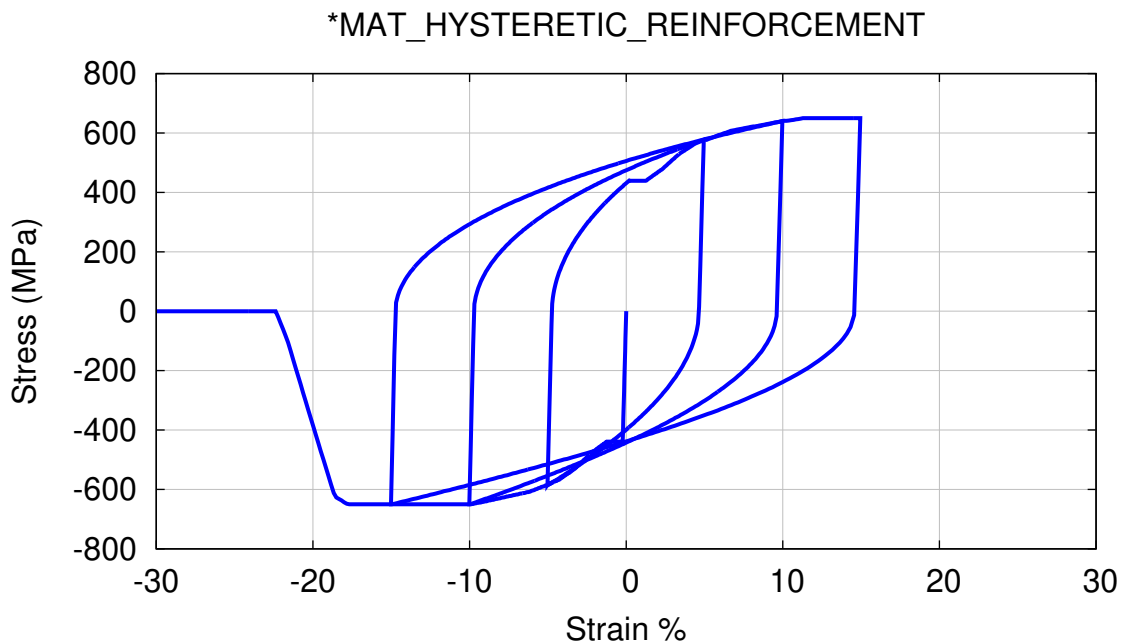

Damage modelling:

Two types of damage accumulation may be modelled. Damage based on ductility (strain) can be modelled using the curves LCTEN and LCCOMP – at high strain, these curves would show reducing stress with increasing strain.

Damage based on hysteretic energy accumulation can be modelled using the parameters EPDAM1, EPDAM2 and DRESID. The damage is a function of accumulated plastic strain: for this purpose, plastic strain increments are always treated as positive in both tension and compression, and buckling strain also counts towards the accumulated plastic strain. The material has its full stiffness and strength until the accumulated plastic strain reaches EPDAM1. Between plastic strains EPDAM1 and EPDAM2 the stiffness and strength fall linearly with accumulated plastic strain, reaching a factor DRESID at plastic strain EPDAM2.

Dowel Action:

The data on Card 3 defines the shear stiffness and strength, and is optional. Shear resistance is assumed to occur by dowel action. The bars bend locally to the crack and crush the concrete. An elastic-perfectly-plastic relation is assumed for all shear components (in-plane and through-thickness). The assumed (smeared) shear modulus and yield stress applicable to the reinforcement bar cross-sectional area are as follows, based on formulae derived from experimental data by El-Ariss, Soroushian, and Dulacska:

$$G[\text{MPa}] = 8.02E^{0.25}F_c^{0.375}L_{\text{char}}D_b^{0.75}$$
$$\tau_y = 1.62\sqrt{F_c S_y}$$

where,

$$E = \text{steel Youngs Modulus in MPa}$$
$$F_c = \text{compressive strength of concrete in MPa}$$
$$L_{\text{char}} = \text{characteristic length of shear deformation in mm}$$
$$D_b = \text{bar diameter in mm}$$
$$S_y = \text{steel yield stress in MPa.}$$

The input parameters should be given in model units, e.g. DBAR and LCHAR are in model length units, FCROW is in model stress units. These will be converted internally using UNITL and UNITC.

Element erosion:

By default, no erosion occurs. Elements will be deleted only if EPDAM1 and EPDAM2 are non-zero, and DRESID is zero, and the accumulated plastic strain reaches EPDAM2. If FRACX and FRACY are both non-zero, i.e. if there is reinforcement in both local directions, then elements are eroded only when the condition above has been reached in both local directions.

Output:

The output stresses, as for all other LS-DYNA material models, are by default in the global coordinate system. They are scaled by the reinforcement fractions FRACX, FRACY. The plastic strain output is the accumulated plastic strain (increments always treated as positive), and is the greater such value of the two local directions. Extra history variables are available as follows:

- Extra variable 1: Reinforcement stress in local x direction (not scaled by FRACX)
- Extra variable 2: Reinforcement stress in local y direction (not scaled by FRACY)
- Extra variable 3: Total strain in local x direction
- Extra variable 4: Total strain in local y direction
- Extra variable 5: Accumulated plastic strain in local x direction
- Extra variable 6: Accumulated plastic strain in local y direction
- Extra variable 7: Shear stress (dowel action) in local xy
- Extra variable 8: Shear stress (dowel action) in local xz
- Extra variable 9: Shear stress (dowel action) in local yz
- Extra variable 10: Maximum (high-tide) total strain in local x direction
- Extra variable 11: Maximum (high-tide) total strain in local y direction

***MAT_DISCRETE_BEAM_POINT_CONTACT**

This is Material Type 205. It is used for discrete beam elements only (ELFORM = 6). It simulates contact forces between a point (Node 2) and an imaginary flat surface (fixed relative to Node 1). The beam elements may have nonzero initial length. On *SECTION_BEAM, SCOOR must be set to -13, the triad rotation option. The triad rotation option ensures that the axis system remains fixed in the imaginary surface.

Card Summary:

Card 1. This card is required.

MID	RO	STIFF	FRIC	DAMP	DMXPZ	LIMPZ	
-----	----	-------	------	------	-------	-------	--

Card 2. This card is required.

DMXPX	DMXNX	DMXPY	DMXNY	LIMPX	LIMNX	LIMPY	LIMNY
-------	-------	-------	-------	-------	-------	-------	-------

Card 3. This card is required.

KROTX	KROTY	KROTZ	TKROT	FBONDH	FBONDT	DBONDH	DBONDT
-------	-------	-------	-------	--------	--------	--------	--------

Card 4. This card is optional.

LCZ	DAMPZ	STIFFH	FRMAX	DAMPH	GAP0	AFAC	
-----	-------	--------	-------	-------	------	------	--

Data Card Definitions:

Card 1	1	2	3	4	5	6	7	8
Variable	MID	RO	STIFF	FRIC	DAMP	DMXPZ	LIMPZ	
Type	A	F	F	F	F	F	F	
Default	none	none	none	0.0	0.0	10 ²⁰	0.0	

VARIABLE**DESCRIPTION**

MID	Material identification. A unique number or label must be specified (see *PART).
RO	Mass density
STIFF	Stiffness (Force/length units)
FRIC	Friction coefficient (dimensionless)

VARIABLE	DESCRIPTION
DAMP	Damping factor (dimensionless), in the range 0 to 1. We suggest a value of 0.5.
DMXPZ	Displacement limit in positive local z-direction (uplift)
LIMPZ	Action when Node 2 passes DMXPZ: EQ.0: Element is deleted. EQ.1: Further displacement is resisted by stiffness STIFF.

Card 2	1	2	3	4	5	6	7	8
Variable	DMXPX	DMXNX	DMXPY	DMXNY	LIMPX	LIMNX	LIMPY	LIMNY
Type	F	F	F	F	F	F	F	F
Default	10 ²⁰	DMXPX	DMXPX	DMXPY	0.0	0.0	0.0	0.0

VARIABLE	DESCRIPTION
DMXPX	Displacement limit in positive local <i>x</i> -direction
DMXNX	Displacement limit in negative local <i>x</i> -direction
DMXPY	Displacement limit in positive local <i>y</i> -direction
DMXNY	Displacement limit in negative local <i>y</i> -direction
LIMPX	Action when Node 2 passes DMXPX: EQ.0: Element is deleted. EQ.1: Further displacement is resisted by stiffness STIFF.
LIMNX	Action when Node 2 passes DMXNX: EQ.0: Element is deleted. EQ.1: Further displacement is resisted by stiffness STIFF.
LIMPY	Action when Node 2 passes DMXPY: EQ.0: Element is deleted. EQ.1: Further displacement is resisted by stiffness STIFF.

VARIABLE**DESCRIPTION**

LIMNY

Action when Node 2 passes DMXNY:

EQ.0: Element is deleted.

EQ.1: Further displacement is resisted by stiffness STIFF.

Card 3	1	2	3	4	5	6	7	8
Variable	KROTX	KROTY	KROTZ	TKROT	FBONDH	FBONDT	DBONDH	DBONDT
Type	F	F	F	F	F	F	F	F
Default	0.0	0.0	0.0	0.0	0.0	0.0	10 ²⁰	10 ²⁰

VARIABLE**DESCRIPTION**

KROTX

Rotational stiffness about local x

KROTY

Rotational stiffness about local y

KROTZ

Rotational stiffness about local z

TKROT

Time at which rotational stiffness becomes active

FBONDH

Force to break initial bond in plane of contact surface

FBONDT

Force to break initial bond in tension, normal to contact surface

DBONDH

Displacement over which bond force in the plane of the contact surface reduces from FBONDH to zero

DBONDT

Displacement over which bond force normal to the contact surface reduces from FBONDT to zero

This card is optional

Card 4	1	2	3	4	5	6	7	8
Variable	LCZ	DAMPZ	STIFFH	FRMAX	DAMPH	GAP0	AFAC	
Type	I	F	F	F	F	F	F	
Default	0	0.0	STIFF	∞	0.0	0.0	1.0	

VARIABLE	DESCRIPTION
LCZ	Optional load curve ID giving force-displacement for compression in local z-direction (abscissa: displacement; ordinate: force). The load curve must be defined in the positive quadrant, meaning that the compressive force values should be defined as positive values.
DAMPZ	Viscous damping coefficient in local z-direction (applied in addition to DAMP) (force/velocity units)
STIFFH	Elastic stiffness in local x- and y-directions
FRMAX	Upper limit on friction force
DAMPH	Viscous damping coefficient in local x- and y-directions (applied in addition to DAMP) (force/velocity units).
GAP0	Initial gap in local z-direction (length units)
AFAC	Scale factor applied to all stiffnesses and forces

Remarks:

1. **Model Description.** This material model simulates contact between a point (Node 2 of the beam element) and an imaginary flat surface which is fixed relative to Node 1. In these remarks we call the imaginary surface the “contact surface” – this does *not* refer to *CONTACT. The local axes are determined by CID on *SECTION_BEAM. The imaginary surface is in the local xy -plane passing through the initial coordinates of Node 2. The local z-axis points outwards from the surface. The surface translates and rotates with Node 1. SCOOR must be set to -13. The elements may have nonzero length.

When Node 2 moves in the negative local z-direction relative to Node 1 (penetration into the contact surface), the motion is resisted by stiffness STIFF and the force generated is described here as the contact force. By default, uplift (Node 2 moving in the positive local z-direction relative to Node 1) is not resisted. If uplift greater than DMXPZ occurs, either the element is deleted (if LIMPZ = 0) or further uplift is resisted by STIFF (if LIMPZ = 1).

Sliding on the surface (motion of Node 2 in the local x- and y-directions) is resisted by friction. The maximum friction force is given by FRIC times the contact force, with an upper limit of FRMAX if that parameter is nonzero. When one of the displacement limits, DMXPX, DMXNX, DMXPY, or DMXNY, is reached, the default behavior is for Node 2 to fall off the edge of the contact surface, and the element is deleted (see [Figure M205-1](#)). Optionally, the input fields LIMPX, LIMNX, LIMPY, and LIMNY can be used to change the behavior to “hard limits” using stiffness STIFF – these represent contact with a hard surface perpendicular to the surface on which Node 2 slides. In that case, the limit distances, DMXPX, DMXNX, DMXPY, and

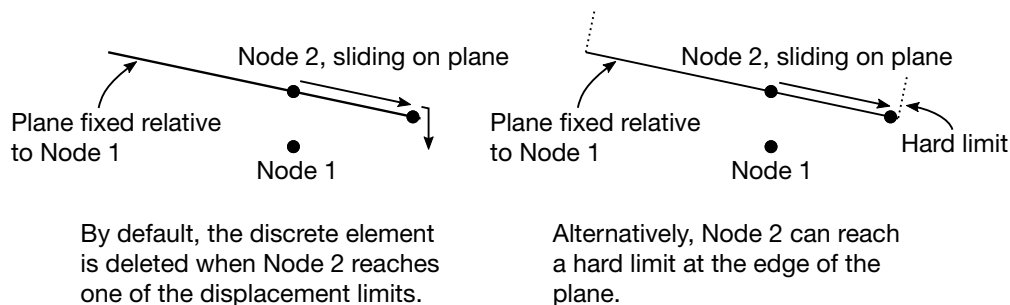

Figure M205-1. Illustration of the two different actions that can be applied to the element when Node 2 reaches the edge of the plane. The left schematic depicts the default behavior in which the element is deleted when Node 2 reaches the edge. The right image illustrates Node 2 reaching a hard limit. When it reaches this limit, a contact force is applied.

DMXNY, represent the initial gap between the point (Node 2) and the hard surface.

Optionally, an initial bond strength can be defined. The bond forces are in addition to any contact and friction forces. After breakage of the bond, contact and sliding can continue to occur.

If LCZ is defined, compressive loading in the contact direction follows LCZ while unload/reload is linear with stiffness STIFF. The value of STIFF must not be less than the maximum slope of any segment of the curve LCZ.

You can also define moment stiffnesses through KROTX, KROTY and KROTZ. Optionally, these stiffnesses can be set to become active at a certain time (TKROT). If TKROT is nonzero, the moment stiffness will be zero before that time and during any dynamic relaxation. If TKROT is left zero, the moment stiffness will be active from the start of the analysis including during dynamic relaxation.

Damping is applied to the force normal to the surface, to the bond forces, and to any forces generated by "hard limits" (LIMPX etc.), but not to sliding. Two damping methods are available: DAMP and DAMPZ/DAMPH. DAMP is recommended for general use where the exact amount of damping is unimportant, and the requirement is simply to remove unwanted oscillations. DAMPZ and DAMPH are available for cases where particular values of viscous damping coefficient are required. When LCZ is also defined and the response is following the load curve (meaning not during unloading/reloading), the damping coefficient DAMPZ is scaled to the ratio of the slope of LCZ to STIFF. The slope of LCZ is the gradient at the current point on the load curve.

2. ***SECTION_BEAM Input.** Note on values for *SECTION_BEAM:
 - a) Set ELFORM to 6 (discrete beam)

- b) CID can be left blank if the contact surface is aligned in the global XY-plane, otherwise a coordinate system should be referenced.
 - c) SCOOR must be set to -13.
3. **Output.** Beam “axial” or “X” force is the force in the local x -direction. “Shear-Y” or “Y” force is the force in the local y -direction. “Shear-Z” or “Z” force is the force in the local z -direction, normal to the contact surface.

Other output is written to the d3plot and d3thdt files in the places where post-processors expect to find the stress and strain at the first integration point for integrated beams:

Integration Point	Post-Processing Data Component	Actual Meaning
1	Axial stress	Displacement in the local x -direction
1	XY shear stress	Displacement in the local y -direction
1	ZX shear stress	Displacement in the local z -direction
1	Plastic strain	Minimum overlap, meaning the minimum value so far during the analysis of the remaining displacement before Node 2 falls of the surface in the x - or y -directions
1	Axial strain	Bond damage

***MAT_SOIL_SANISAND**

This is Material Type 207. It is supported for solid elements only. It is intended for modelling sands and sandy soils under monotonic and cyclic loading conditions. Cyclic shear loading leads to dilative and contractive volumetric behavior based on critical state soil mechanics. When used together with LS-DYNA's pore fluid analysis capabilities, liquefaction and related phenomena can be modelled. See Remarks below.

Card Summary:

Card 1. This card is required.

MID	RO	GO	KONU	PREF	RHOC	THETA	X
-----	----	----	------	------	------	-------	---

Card 2. This card is required.

EIN	ALPHAC	E0	LAMBDA	XI	NB	H0	CH
-----	--------	----	--------	----	----	----	----

Card 3. This card is required.

PO	CC	ND	A0				
----	----	----	----	--	--	--	--

Card 4. This card is required.

ANISO	KH	ZMAX	CZ				
-------	----	------	----	--	--	--	--

Card 5. This card is required.

PATM	M	N	V				
------	---	---	---	--	--	--	--

Data Card Definitions:

Card 1	1	2	3	4	5	6	7	8
Variable	MID	RO	GO	KONU	PREF	RHOC	THETA	X
Type	A	F	F	F	F	F	F	F
Default	none	none	none	none	none	0.37	none	none

VARIABLE	DESCRIPTION
MID	Material identification. A unique number or label must be specified (see *PART).
RO	Mass density
G0	Shear modulus term G_0 . See Remark 6 .
K0NU	Elastic constant (see Remark 6): GT.0.0: Bulk modulus term K_0 LT.0.0: Absolute value is Poisson's ratio, ν .
PREF	Reference pressure in Limiting Compression Curve, associated with unity void ratio. See Remark 10 .
RHOC	Exponent in Limiting Compression Curve, ρ_c . See Remark 10 .
THETA	Exponent in transitional compression behavior, θ . See Remark 10 .
X	Material constant X. See Remark 10 .

Card 2	1	2	3	4	5	6	7	8
Variable	EIN	ALPHAC	E0	LAMBDA	XI	NB	H0	CH
Type	F	F	F	F	F	F	F	F
Default	none	none	none	none	0.7	none	none	none

VARIABLE	DESCRIPTION
EIN	Initial void ratio
ALPHAC	Critical surface angle in $q-p$ space, α_c^c . See Remark 8 .
E0	Material constant in Critical State Line, e_0 . See Remark 8 .
LAMBDA	Material constant in Critical State Line, λ . See Remark 8 .
XI	Material constant in Critical State Line, ξ . See Remark 8 .
NB	Bounding surface parameter, n^b . See Remark 8 .

VARIABLE	DESCRIPTION
-----------------	--------------------

H0 Kinematic hardening parameter, h_0 . See [Remark 7](#).

CH Kinematic hardening parameter, c_h . See [Remark 7](#).

Card 3	1	2	3	4	5	6	7	8
Variable	P0	CC	ND	A0				
Type	F	F	F	F				
Default	none	0.778	none	none				

VARIABLE	DESCRIPTION
-----------------	--------------------

P0 Initial value of yield surface parameter, p_0 . See [Remark 7](#).

CC Ratio of critical surface angle in extension to critical surface angle in compression, c . See [Remark 8](#).

ND Dilatancy surface parameter, n_d . See [Remark 8](#).

A0 Dilatancy parameter, A_0

Card 4	1	2	3	4	5	6	7	8
Variable	ANISO	KH	ZMAX	CZ				
Type	F	F	F	F				
Default	0.333	1.0	none	none				

VARIABLE	DESCRIPTION
-----------------	--------------------

ANISO Inherent fabric anisotropy measure. See [Remark 12](#).

KH Material constant, k_h , in dependence of hardening parameters on inherent fabric anisotropy. See [Remark 12](#).

ZMAX Material constant for fabric change effect, z_{\max} . See [Remark 11](#).

VARIABLE	DESCRIPTION
CZ	Material constant for fabric change effect, c_z . See Remark 11 .

Card 5	1	2	3	4	5	6	7	8
Variable	PATM	M	N	V				
Type	F	F	F	F				
Default	none	0.05	20.0	1000.0				

VARIABLE	DESCRIPTION
PATM	Atmospheric pressure, p_{atm}
M	Yield surface constant, m . See Remark 7 .
N	Yield surface constant, n . See Remark 7 .
V	Flow rule constant, V

Remarks:

- References.** SANISAND (an acronym for Simple ANIsootropic SAND) is a family of constitutive models within the frameworks of critical state soil mechanics and bounding surface plasticity. Although the overall principles remain the same, different research teams have developed versions of SANISAND with different details. The material model implemented in LS-DYNA as *MAT_SANISAND is based on Dafalias and Manzari [2004] with high-pressure yield surface cap from Taiebat and Dafalias [2008] and options for inherent fabric anisotropy taken from Dafalias, Papadimitriou, and Li [2004]. The references give the constitutive model equations both in “triaxial formulation” (in which there are only two stress variables q and p), and in “multi-axial formulation” (in which the deviatoric stress-related terms are tensors). The LS-DYNA implementation follows the multi-axial formulation, but, in these Remarks, equations are given in triaxial formulation for ease of understanding the principles.
- Pore pressure build-up and liquefaction.** Pore water pressure build-up occurs when the “soil skeleton” contracts (for example, under cyclic shearing), leaving a greater proportion of the external load to be supported by the pore water and a lesser proportion acting on the soil skeleton, that is, the effective stress is reduced. Since sandy soils are frictional materials, reduced effective stress leads

to reduced shear stiffness and reduced shear strength. It ultimately leads to liquefaction of the soil. Therefore, accurate modelling of pore pressure build-up and liquefaction effects depend critically on accurate dilation/contraction behavior of the material model, which is a key aspect of the SANISAND material model.

3. **Modeling pore pressure.** Pore pressure is not included in the material model itself. As with other LS-DYNA soil models, the material model represents the effective stress (soil skeleton) behavior. Pore pressure can be modelled with *CONTROL_PORE_FLUID and *BOUNDARY_PORE_FLUID. The analysis type should be set to Undrained or Time Dependent Consolidation (ATYPE = 1 or 3, respectively) in order for pore pressure changes to occur in response to the dilation or contraction of the soil.
4. **Void ratio.** Soils consist of solid particles with voids between them. Many of the equations governing the behavior of this material model are given in terms of the void ratio, e . The volume of voids divided by the volume of solids gives the void ratio. It is a measure of how loosely or tightly packed the particles are (the lower the void ratio, the more tightly packed). The void ratio at the start of the analysis is given by input parameter EIN. The void ratio varies during the analysis: volumetric strains are assumed to relate to changes of void volume, while the volume of solids remains unchanged.
5. **Stress ratio.** Most elasto-plastic constitutive models are described in terms of their stress-strain behavior. For frictional materials, such as sandy soils, shear strength is considered proportional to pressure. Thus, it is more appropriate to define the equations in terms of stress ratio rather than stress. Stress ratio in triaxial formulation is a scalar quantity η equal to q/p (where q is Von Mises stress and p is pressure). In the multi-axial formulation, the stress ratio is a tensor quantity equal to the deviatoric stress tensor divided by pressure. Stress ratios described in the references include the “dilatancy stress ratio” (also called the “phase transformation line”) which marks the boundary between contractive and dilative response to shear strains, the “critical state stress ratio” (see [Remark 8](#)), and the “bounding stress ratio” at which shear failure occurs.
6. **Elastic properties.** The elastic shear modulus, G , is given by:

$$G = G_0 p_{\text{atm}} \frac{(2.97 - e)^2}{1 + e} \left(\frac{p}{p_{\text{atm}}} \right)^{1/2}$$

where G_0 and p_{atm} are the input parameters G0 and PATM, p is the current pressure, and e is the current void ratio.

If input parameter KONU is positive, then the bulk modulus, K , is given by:

$$K = K_0 p_a \frac{1 + e}{e} \left(\frac{p}{p_{\text{atm}}} \right)^{2/3}$$

where K_0 is the input parameter K0NU. If input parameter K0NU is negative, then the bulk modulus, K , is given by:

$$K = \frac{2(1 + \nu)}{3(1 - 2\nu)}G$$

where $\nu = -K0NU$.

7. **Yield surface and hardening.** The yield surface is defined as a narrow cone of semi-angle m centered on a back stress ratio α which, together with the hardening rule, enables realistic nonlinear unload/reload behavior under cyclic loading. The yield surface is closed at the high pressure end by a cap-like feature that models grain crushing using parameter p_0 , as described in Taiebat and Dafalias [2008]:

$$f = (q - p\alpha)^2 - m^2 p^2 \left[1 - \left(\frac{p}{p_0} \right)^n \right] = 0$$

where m and n are input parameters M and N (see Card 5), and p_0 has an initial value given by input parameter P0. Description of the flow rule and evolution of α and p_0 are given in the references. The yield surface as described in Dafalias and Manzari [2004] is the same as above except that it lacks the term in square brackets, which corresponds to a yield surface cap at high pressure. When P0 is set to a high value compared to the expected pressure, the yield surface in this material model becomes the same as that of Dafalias and Manzari [2004].

Hardening is described by a “stress ratio hardening modulus”, H , which is the rate of change of stress ratio η with deviatoric plastic strain:

$$H = \frac{d\eta}{d\varepsilon_p} = \frac{G_0 |h_0| (1 - c_h e) (\alpha_b - \eta)}{R} \left(\frac{p}{p_{atm}} \right)^{-1/2}.$$

Here h_0 is the input parameter H0, c_h is the input parameter CH, $\alpha_b - \eta$ is the “distance” (in stress ratio terms) between the current stress ratio and its image on the bounding surface for loading in the current loading direction. R is defined as given in Equations 5, 6, and 24 of Dafalias and Manzari [2004] and can be considered as the “distance” (in stress ratio terms) between the current stress ratio and the stress ratio where the current plastic loading cycle began (such as at the most recent loading direction reversal). This term is zero on initial loading and immediately following a stress reversal, giving an instantaneously infinite hardening slope and a smooth transition between elastic and plastic behavior.

If the anisotropy parameter ANISO has a non-default value, anisotropy effects are included as per Equation 15 in Dafalias, Papadimitriou and Li [2004].

8. **Critical state.** The critical state is a combination of values of stress ratio, pressure, and void ratio at which the application of shear strain causes no change to any of those three parameters. It is assumed that soil starting from any initial state, if subjected to sufficient shear strain, will tend towards and eventually

reach a critical state. In MAT_SANISAND, the critical state void ratio, e_c , is defined as follows:

$$e_c = e_0 - \lambda(p/p_a)^{\zeta} .$$

In the above, e_0 , λ , ζ , and p_a are input parameters E0, LAMBDA, XI and PATM, respectively. If the anisotropy parameter ANISO has a non-default value, e_0 in the above equation is replaced by $e_0 \exp(-A)$ where A is the lode angle-dependent state parameter described in Dafalias, Papadimitriou and Li [2004].

The state parameter ψ is given by $e - e_c$, which may be thought of as the distance from the critical state in terms of void ratio.

The critical state stress ratio, α_c^c , is a constant given by the input parameter ALPHAC. If the material is on the critical state line in $e-p$ space according to the above equation, that is, when $\psi = 0$, then both the dilatancy stress ratio, α^d , and the bounding stress ratio, α^b , coincide with the critical state stress ratio. These stress ratios vary with ψ in the following manner:

$$\begin{aligned} \alpha^d &= c\alpha_c^c \exp(n^d \psi) \\ \alpha^b &= c\alpha_c^c \exp(-n^b \psi) \end{aligned}$$

where n^d and n^b are the input parameters ND and NB, respectively, and $c = 1$ for compressive loading. For extension loading, c is equal to the input parameter CC.

9. **Dilation and contraction.** The volumetric plastic strain increment is linked to the deviatoric plastic strain increment through a dilation angle, D . D is defined such that the volumetric plastic strain is contractive at stress ratios below α^d and dilative at stress ratios above α^d :

$$D = \frac{\dot{\epsilon}_v^p}{\dot{\epsilon}_q^p} = sA_d(\alpha^d - \alpha) .$$

In the above equation, $\dot{\epsilon}_v^p$ and $\dot{\epsilon}_q^p$ are the volumetric and deviatoric plastic strain increments, s takes the value 1 or -1 according to loading direction, and A_d is the input parameter A0. If the fabric change parameters ZMAX and CZ are defined (see Remark 11), A_d is scaled according to Equation 12 of Dafalias and Manzari [2004].

10. **Limiting Compression Curve (LCC).** The maximum pressure that the material can sustain is governed by the LCC, which is analogous to a yield curve in pressure-void ratio space. The LCC consists of points (p_{LCC}, e_{LCC}) such that:

$$\log e_{LCC} = -\rho_c \log \left(\frac{p_{LCC}}{p_{REF}} \right) .$$

Here ρ_c and p_{REF} are the input parameters RHOC and PREF. The transition from elastic volumetric response to plastic volumetric deformation along the LCC is a smooth function governed by input parameters THETA, and X. See Taiebat and Dafalias [2008] for further details.

11. **Fabric change.** Input parameters ZMAX and CZ control the fabric change effect described by Dafalias and Manzari [2004]. During cyclic shearing, in the dilatant phase the contact surfaces between the sand particles are re-oriented in a manner that greatly increases the contractive tendency upon subsequent reversal of the shearing direction. If this effect is not modelled, simulations of cyclic shearing may tend to stabilize at a nonzero effective pressure in cases where experiments would show the effective pressure diminishing to zero.
12. **Fabric anisotropy.** Input parameters ANISO and KH control the fabric anisotropy effect described by Dafalias, Papadimitriou and Li [2004]. The default, given by ANISO = 1/3 and KH=1, is isotropic behavior. Non-default values cause the plastic hardening behavior and the critical state line to depend on a lode-angle, leading to a better match of experimental results under a wide variety of stress states. ANISO = 0 corresponds to a fabric formation where particles lie entirely on the global XY-plane. ANISO = 1 implies a fabric formation where particles are oriented entirely parallel to the vertical global Z-direction. It is expected that the most common cases will be in the range of $0 < ANISO < 1/3$, i.e., with a preference toward horizontal orientations.
13. **Output.** The current void ratio, e , is output in place of plastic strain.

References:

- [1] Taiebat M. and Dafalias, Y. F. "SANISAND: simple anisotropic sand plasticity model." *International Journal for Numerical and Analytical Methods in Geomechanics*, 32(8), 915–948 (2008).
- [2] Dafalias, Y. F. and Manzari, M.T. "Simple plasticity sand model accounting for fabric change effects." *Journal of Engineering Mechanics*, 130(6), 622–634 (2004).
- [3] Dafalias, Y. F., Papadimitriou, A. G., and Li, X. S. "Sand plasticity model accounting for inherent fabric anisotropy." *Journal of Engineering Mechanics*, 130(11), 1319–1333 (2004).

***MAT_BOLT_BEAM**

This is Material Type 208 for use with beam elements using ELFORM = 6 (discrete beam). The beam elements must have nonzero initial length so that the directions in which tension and compression act can be distinguished. See [Remarks 1](#) and [2](#).

Card 1	1	2	3	4	5	6	7	8
Variable	MID	RO	KAX	KSHR	blank	blank	FPRE	TRAMP
Type	A	F	F	F			F	F
Default	none	none	0.0	0.0			0.0	0.0

Card 2	1	2	3	4	5	6	7	8
Variable	LCAX	LCSHR	FRIC	CLEAR	DAFAIL	DRFAIL	DAMAG	TOPRE
Type	I	I	F	F	F	F	F	F
Default	0	0	0.0	0.0	10 ²⁰	10 ²⁰	0.1	0.0

Card 3	1	2	3	4	5	6	7	8
Variable	DACFAIL	AXSHFL	HOLSHR	IAXIS				
Type	F	I	I	I				
Default	10 ²⁰	0	0	1				

VARIABLE**DESCRIPTION**

MID	Material identification. A unique number or label must be specified (see *PART).
RO	Mass density
KAX	Axial elastic stiffness (Force/Length units)

VARIABLE	DESCRIPTION
KSHR	Shear elastic stiffness (Force/Length units)
FPRE	Preload force
TRAMP	Time duration during which preload is ramped up
LCAX	Load curve giving axial load as a function of plastic displacement (x -axis = displacement (length units), y -axis = force). See Remark 4 .
LCSHR	Load curve ID or table ID giving lateral load as a function of plastic displacement (x -axis - displacement (length units), y -axis - force). In the table case, each curve in the table represents lateral load as a function of displacement at a given (current) axial load, meaning the values in the table are axial forces. See Remark 4 .
FRIC	Friction coefficient resisting sliding of bolt head/nut (non-dimensional)
CLEAR	Radial clearance (gap between bolt shank and the inner diameter of the hole) (length units). See Remark 5 .
DAFAIL	Axial tensile displacement at which failure is initiated (length units)
DRFAIL	Radial displacement at which failure is initiated (excludes clearance)
DAMAG	Failure is completed at $(DAFAIL \text{ or } DRFAIL \text{ or } DACFAIL) \times (1 + DAMAG)$
TOPRE	Time at which preload application begins
DACFAIL	Axial compressive displacement at which failure is initiated (positive value, length units)
AXSHFL	Flag to determine effect on axial response of increase of length of element due to shear displacement. In this context, shear displacement excludes sliding within the clearance gap. See Remark 6 . EQ.0: Shear-induced length increase treated as axial load. EQ.1: Shear-induced length increase is ignored.

VARIABLE	DESCRIPTION
HOLSHR	<p>Flag for hole enlargement due to shear (see Remark 7):</p> <p>EQ.0: Hole does not enlarge due to shear deformation.</p> <p>NE.0: Shear deformation after bolt contacts the inner diameter of the hole enlarges the hole.</p>
IAXIS	<p>Flag to determine how the bolt axis relates to the beam element local axes. See Remark 2.</p> <p>EQ.1: Each element creates own axes, bolt axis (N1-N2 direction) is local x (default)</p> <p>EQ.2: Each element creates own axes, bolt axis (N1-N2 direction) is local y</p> <p>EQ.3: Each element creates own axes, bolt axis (N1-N2 direction) is local z</p> <p>EQ.4: Axis system defined by CID on *SECTION_BEAM, bolt axis is local x</p> <p>EQ.5: Axis system defined by CID on Section card, bolt axis is local y</p> <p>EQ.6: Axis system defined by CID on Section card, bolt axis is local z</p>

Remarks:

1. **Bolted Joint Geometry.** The element represents a bolted joint. The nodes of the beam should be thought of as representing the points at the centers of the holes in the plates that are joined by the bolt.
2. **Local Axes.** There are three options for defining the bolt axis direction and local axis system for elements of this material type. Here, "bolt axis" means the direction in which tension is applied, while shear forces are perpendicular to the bolt axis. "Local axes" means the axis system in which the element's deformations are calculated and its forces are output. By default, the bolt axis coincides with the local x -axis, although that can be changed using the input parameter IAXIS.
 - a) **Local axes defined by a *DEFINE_COORDINATE_NODES that has FLAG set to 1.** The coordinate system is referenced either as CID on *SECTION_BEAM or through PARAM3 on *ELEMENT_BEAM_THICKNESS. The behavior is then as follows:

- i) The local axis system is defined by the three nodes of the *DEFINE_COORDINATE_NODES throughout the analysis, as described in the Remarks under *DEFINE_COORDINATE_NODES. The initial direction given by Nodes 1 and 2 of the beam element and the rotation of the local system based on SCOOR from *SECTION_BEAM are both irrelevant in this case.
 - ii) By default, the axial direction of the bolt coincides with the local x -axis of the *DEFINE_COORDINATE_NODES. Tension (positive force) is generated when Node 2 displaces in the positive local x direction relative to Node 1. Care is needed to ensure that the beam element topology is defined with Node 1 and Node 2 the correct way around to generate tension in the expected direction – for example, having Node 2 initially offset in the positive local x direction from Node 1 will mean that tension is generated when the beam element elongates in the local x -direction.
 - iii) The axial direction of the bolt can be oriented along the local y - or z -axis instead of the local x -axis by setting IAXIS to 2 or 3, respectively.
 - iv) For bolts that are differently oriented, you will need to *either* separate them into different *PARTs (so that the different *DEFINE_COORDINATE_NODES can be referenced by different *SECTION_BEAM cards) *or* have PARAM3 on *ELEMENT_BEAM_THICKNESS reference the needed *DEFINE_COORDINATE_NODES coordinate system.
- b) **Bolt axis defined by the initial orientation of the beam element.** To obtain this behavior, set CID = 0 on *SECTION_BEAM (and set PARAM3 = 0 if using *ELEMENT_BEAM_THICKNESS), and position Nodes 1 and 2 of each beam element with a nonzero distance between them, aligned with the axis of the bolt. Note that the behavior described below will also occur if IAXIS < 4 and CID is nonzero, but the referenced coordinate system is a *DEFINE_COORDINATE_SYSTEM or a *DEFINE_COORDINATE_NODES with FLAG = 0 (i.e. it does not fulfill all the conditions for a) above).
- i) Each beam element automatically creates its own axis system where the bolt axis is initially in the direction defined by Node 1 to Node 2. Note that this behavior is different than that for other Discrete Beam material types.
 - ii) During the analysis, the local axis system rotates as defined by SCOOR on *SECTION_BEAM. For example, if SCOOR = -13, the axes rotate with Node 1. We recommend using SCOOR = -13 or +13.

- iii) The bolt axis is always initially coincident with the Node 1 to Node 2 direction, but IAXIS = 1, 2 or 3 controls whether the bolt axis is labelled as the local x -, y - or z -axis. This setting has no effect on the analysis, only on the output of results for post-processing. This can be useful when post-processing discrete beams of different material types so that, for example, the beam z -force has a similar meaning across the different material types.
- c) **Local axes initially defined by a *DEFINE_COORDINATE_OPTION with rotation of the axes controlled by SCOOR.** To obtain this behavior, the coordinate system should be specified by either *DEFINE_COORDINATE_SYSTEM or *DEFINE_COORDINATE_NODES with FLAG = 0. Reference the coordinate system as CID on *SECTION_BEAM (or as PARAM3 on *ELEMENT_BEAM_THICKNESS) and set IAXIS to 4, 5 or 6. The behavior is as follows:
- i) The local axis system defined with CID on *SECTION_BEAM (or PARAM3 on *ELEMENT_BEAM_THICKNESS) is used. The initial direction Node 1 to Node 2 has no influence on the local axes or the bolt axis direction.
 - ii) During the analysis, the local axis system rotates as defined by SCOOR on *SECTION_BEAM. For example, if SCOOR = -13, the axes rotate with Node 1. We recommend using SCOOR = -13 or +13.
 - iii) The bolt axis is oriented along the local x -, y - or z -axis according to whether IAXIS = 4, 5 or 6, respectively.
 - iv) Care is needed to ensure that the beam element topology is defined with Node 1 and Node 2 the correct way around to generate tension in the expected direction – for example, if IAXIS = 4, having Node 2 initially offset in the positive local x direction from Node 1 will mean that tension is generated when the beam element elongates in the local x direction.
 - v) For bolts that are differently oriented, you will need to *either* separate them into different *PARTs (so that the different *DEFINE_COORDINATE_NODES can be referenced by different *SECTION_BEAM cards) *or* have PARAM3 on *ELEMENT_BEAM_THICKNESS reference the needed *DEFINE_COORDINATE_NODES coordinate system.
3. **Axial Response.** The axial response is tensile only. If the element shortens in the bolt axis direction, instead of generating a compressive axial load, a gap is assumed to develop between the bolt head (or nut) and the surface of the plate.

Contact between the bolted surfaces must be modelled separately, such as using *CONTACT or another discrete beam element.

4. **Yield Force Curves.** Curves LCAX and LCSHR give yield force as a function of plastic displacement for the axial and shear directions, respectively. The force increments are calculated from the elastic stiffnesses, subject to the yield force limits given by the curves.
5. **Sliding Shear Displacement.** CLEAR allows the bolt to slide in shear, resisted by friction between bolt head/nut and the surfaces of the plates, from the initial position at the center of the hole. CLEAR is the total sliding shear displacement before contact occurs between the bolt shank and the inside surface of the hole. Sliding shear displacement is not included in the displacement used for LCSHR. LCSHR is intended to represent the behavior after the bolt shank contacts the edge of the hole.
6. **Shear Deformation and Axial Tension.** If KSHR and LCSHR represent deformation and rotation of the bolt itself, AXSHFL = 0, the default setting, is recommended. On the other hand, if KSHR and LCSHR represent deformation of the bearing surfaces, AXSHFL = 1 is recommended, and HOLSHR = 1 is likely to be appropriate too (see [Remark 7](#)).

The explanation is as follows. Consider the case where a shear displacement is applied to the bolted joint, while the plates are constrained to remain the same distance apart. Mechanisms by which a bolted joint can displace in the shear direction include:

- a) the bolt sliding within a clearance gap;
- b) rotation, bending and shearing of the bolt itself; and
- c) deformation of the bearing surfaces while the bolt itself remains almost rigid and perpendicular to the plates.

The tension in the bolt might be expected to increase when mechanism (b) occurs because the length of the bolt itself must increase (in this example, the plates are held the same distance apart). Tension in the bolt would not increase with mechanisms (a) or (c). In the LS-DYNA model, applying shear while holding the plates the same distance apart will cause the element to lengthen. When calculating the axial force in the bolt, *MAT_BOLT_BEAM always ignores any lengthening due to mechanism (a) but is unable to distinguish between (b) and (c) – KSHR and LCSHR could represent either or both types of mechanism. AXSHFL tells *MAT_BOLT_BEAM whether to treat these shear deformations as contributing to changes of length to the bolt itself, and hence whether axial tension will be generated.

- 7. **Hole Enlargement.** If HOLSHR is nonzero, shear deformation beyond that necessary to close the clearance gap enlarges the hole in the plates and does not deform the bolt itself. The force-deformation relation of this mechanism is still governed by LCSHR, and the deformation (that is, enlargement of the hole) is tracked separately in each of the local $-y$, $+y$, $-z$, and $+z$ directions. Thus, for example, enlargement of the hole in the positive Y direction has no effect on the position of the edge of the hole in the negative Y direction. When HOLSHR is used, AXSHFL should be set to 1.

- 8. **Output.** Beam “axial” or “X” force is the axial force in the beam. “shear-Y” and “shear-Z” are the shear forces. Other output is written to the d3plot and d3thdt files in the places where post-processors expect to find the stress and strain at the first two integration points for integrated beams.

Integration Point	Post-Processing Data Component	Actual Meaning
1	Axial Stress	Change of length
1	XY Shear stress	Sliding shear displacement in local y
1	ZX Shear stress	Sliding shear displacement in local Z
1	Plastic strain	Resultant shear sliding displacement
1	Axial strain	Axial plastic displacement
2	Axial Stress	Shear plastic displacement excluding sliding
2	XY Shear stress	Not used
2	ZX Shear stress	Not used
2	Plastic strain	Not used
2	Axial strain	Not used

***MAT_HYSTERETIC_BEAM**

This is Material Type 209. It can be used only with resultant beam elements (ELFORM = 2). It is intended for modelling buildings in seismic analysis and is similar to *MAT_191 but with increased capabilities. Plastic hinges can form at both ends of the element, and plasticity options are available for axial and shear behavior as well as bending. The yield surface incorporates moment-axial interaction. Advanced features implemented for this material include hinge locations and pinching effect (Card 3), asymmetry and shear failure (Card 4), Bauschinger effect (Card 5), stiffness degradation (Cards 6 and 7), and FEMA flags (Cards 8, 9, and 10).

Card Summary:

Card 1. This card is required.

MID	RO	E	PR	IAX	ISURF	IHARD	IFEMA
-----	----	---	----	-----	-------	-------	-------

Card 2. This card is required.

LCPMS	SFS	LCPMT	SFT	LCAT	SFAT	LCAC	SFAC
-------	-----	-------	-----	------	------	------	------

Card 3. This card is required.

ALPHA	BETA	GAMMA	F0	PINM	PINS	HLOC1	HLOC2
-------	------	-------	----	------	------	-------	-------

Card 4. This card is required.

DELTAS	KAPPAS	DELTAT	KAPPAT	LCSHS	SFSHS	LCSHT	SFSHT
--------	--------	--------	--------	-------	-------	-------	-------

Card 5. This card is required.

HARDMS	GAMMS	HARDMT	GAMMT	HARDAT	GAMAT	HARDAC	GAMAC
--------	-------	--------	-------	--------	-------	--------	-------

Card 6. This card is required.

OMGMS1	OMGMS2	OMGMT1	OMGMT2	OMGAT1	OMGAT2	OMGAC1	OMGAC2
--------	--------	--------	--------	--------	--------	--------	--------

Card 7. This card is required.

RUMS	RUMT	DUAT	DUAC	LAM1	LAM2	SOFT1	SOFT2
------	------	------	------	------	------	-------	-------

Card 8. Include this card if IFEMA > 0.

PRS1	PRS2	PRS3	PRS4	PRT1	PRT2	PRT3	PRT4
------	------	------	------	------	------	------	------

Card 9. Include this card if IFEMA > 1.

TS1	TS2	TS3	TS4	CS1	CS2	CS3	CS4
-----	-----	-----	-----	-----	-----	-----	-----

Card 10. Include this card if IFEMA > 2.

SS1	SS2	SS3	SS4	ST1	ST2	ST3	ST4
-----	-----	-----	-----	-----	-----	-----	-----

Data Card Definitions:

Card 1	1	2	3	4	5	6	7	8
Variable	MID	RO	E	PR	IAX	ISURF	IHARD	IFEMA
Type	A	F	F	F	I	I	I	I
Default	none	none	none	none	1	1	2	0

VARIABLE

DESCRIPTION

MID	Material identification. A unique number or label must be specified (see *PART).
RO	Mass density
E	Young's modulus
PR	Poisson's ratio
IAX	Abscissa definition for axial yield force as a function of inelastic deformation/strain curves (LCAT and LCAC on Card 2): EQ.1: plastic deformation (change in length) EQ.2: nominal plastic strain, that is, $\frac{\text{plastic deformation}}{\text{initial length}}$
ISURF	Yield surface type for interaction (see Remark 2): EQ.1: simple power law (default) EQ.2: power law based on resultant moment EQ.3: skewed yield surface version of ISURF = 2 (see Remark 5)

VARIABLE	DESCRIPTION
IHARD	Hardening type during cyclic response (see Remark 6): EQ.1: cumulative absolute deformation EQ.2: peak deformation EQ.3: peak deformation, yield-oriented EQ.4: peak deformation, peak-oriented
IFEMA	Flag for input of FEMA thresholds (Cards 8, 9 and 10; see Remarks 9 and 11): EQ.0: no input EQ.1: input of rotation thresholds only EQ.2: input of rotation and axial strain thresholds EQ.3: input of rotation, axial strain and shear strain thresholds

Card 2	1	2	3	4	5	6	7	8
Variable	LCPMS	SFS	LCPMT	SFT	LCAT	SFAT	LCAC	SFAC
Type	I	F	I	F	I	F	I	F
Default	none	1.0	LCPMS	SFS	none	1.0	LCAT	SFAT

VARIABLE	DESCRIPTION
LCPMS	Load curve ID (See *DEFINE_CURVE) giving normalized yield moment as a function of plastic rotation at hinges about the local <i>s</i> -axis. All values are positive.
SFS	Representative yield moment for plastic hinges about local the <i>s</i> -axis (scales the normalized moment from LCPMS)
LCPMT	Load curve ID (See *DEFINE_CURVE) giving normalized yield moment as a function of plastic rotation at hinges about the local <i>t</i> -axis. All values are positive.
SFT	Representative yield moment for plastic hinges about local the <i>t</i> -axis (scales the normalized moment from LCPMT)

VARIABLE	DESCRIPTION
LCAT	Load curve ID (See *DEFINE_CURVE) giving normalized axial tensile yield force as a function of inelastic deformation/strain. See IAX above for definition of deformation/strain. All values are positive. See *DEFINE_CURVE.
SFAT	Representative tensile strength (scales the normalized force from LCAT)
LCAC	Load curve ID (See *DEFINE_CURVE) giving normalized axial compressive yield force as a function of inelastic deformation/strain. See IAX above for definition of deformation/strain. All values are positive. See *DEFINE_CURVE.
SFAC	Representative compressive strength (scales the normalized force from LCAC)

Card 3	1	2	3	4	5	6	7	8
Variable	ALPHA	BETA	GAMMA	F0	PINM	PINS	HLOC1	HLOC2
Type	F	F	F	F	F	F	F	F
Default	2.0	2.0	2.0	0.0	1.0	1.0	0.0	0.0

VARIABLE	DESCRIPTION
ALPHA	<p>Parameter to define moment-axial yield surface:</p> <p>GT.0.0: yield surface parameter ALPHA (must not be < 1.1); see Remark 2.</p> <p>LT.0.0: user-defined yield surface for the local s-axis. ALPHA is the load curve ID giving the yield locus. The abscissa is the moment about the local s-axis; the ordinate is the axial force (tensile positive). See Remark 4.</p>
BETA	<p>Parameter to define moment-axial yield surface:</p> <p>GT.0.0: yield surface parameter BETA (must not be < 1.1); see Remark 2.</p>

VARIABLE	DESCRIPTION
	LT.0.0: user-defined yield surface for the local t -axis. BETA is the load curve ID giving the yield locus. Abscissa is moment about the local t -axis; the ordinate is the axial force (tensile positive). See Remark 4 .
GAMMA	Parameter to define yield surface which must not be < 1.1 (see Remark 2)
F0	Force at which maximum yield moment is achieved (tensile positive; for reinforced concrete, a negative (compressive) value would be entered).
PINM	Pinching factor for flexural hysteresis (for IHARD = 3 or 4 only). See Remark 7 .
PINS	Pinching factor for shear hysteresis (for IHARD = 3 or 4 only). See Remark 7 .
HLOC1	Location of plastic Hinge 1 from Node 1 (see Remark 1): <ul style="list-style-type: none"> GE.0.0: HLOC1 is the distance of Hinge 1 to Node 1 divided by element length. LT.0.0.AND.GT.-1.0: -HLOC1 is the distance of Hinge 1 to Node 1 divided by element length; deactivate shear yielding. EQ.-1.0: deactivate Hinge 1. EQ.-10.0: deactivate shear yielding; Hinge 1 is located at Node 1. EQ.-11.0: deactivate Hinge 1 and shear yielding.
HLOC2	Location of plastic Hinge 2 from Node 2 (see Remark 1): <ul style="list-style-type: none"> GE.0.0: HLOC2 is the distance of Hinge 2 to Node 2 divided by element length. LT.0.0.AND.GT.-1.0: HLOC2 is the distance of Hinge 2 to Node 2 divided by element length; deactivate shear yielding. EQ.-1.0: deactivate Hinge 2. EQ.-10.0: deactivate shear yielding; Hinge 2 is located at Node 2. EQ.-11.0: deactivate Hinge 2 and shear yielding.

Card 4	1	2	3	4	5	6	7	8
Variable	DELTAS	KAPPAS	DELTAT	KAPPAT	LCSHS	SFSHS	LCSHT	SFSHT
Type	F	F	F	F	F	F	F	F
Default	0.0	0.0	0.0	0.0	none	1.0	LCSHS	SFSHS

VARIABLE**DESCRIPTION**

DELTAS	Parameter to define the skew for yield surface (ISURF = 3); see Remark 2 .
KAPPAS	Parameter to define the skew for yield surface (ISURF = 3); see Remark 2 .
DELTAT	Parameter to define the skew for yield surface (ISURF = 3); see Remark 2 .
KAPPAT	Parameter to define the skew for yield surface (ISURF = 3); see Remark 2 .
LCSHS	Load curve ID (see *DEFINE_CURVE) giving yield shear force as a function of inelastic shear strain (shear angle) in the local <i>s</i> -direction (see Remark 10).
SFSHS	Scale factor on yield shear force in the local <i>s</i> -direction (scales the force from LCSHS): GT.0.0: constant scale factor LT.0.0: user-defined interaction with axial force. SFSHS is the load curve ID giving scale factor as a function of normalized axial force (tensile is positive). The normalization uses SFAT for tensile force and SFAC for compressive force. For example, point (-1.0,0.5) on the curve defines a scale factor of 0.5 for compressive force of -SFAC.
LCSHT	Load curve ID (see *DEFINE_CURVE) giving yield shear force as a function of inelastic shear strain (shear angle) in the local <i>t</i> -direction (see Remark 10).
SFSHT	Scale factor on yield shear force in the local <i>t</i> -direction (scales the force from LCSHS).

VARIABLE**DESCRIPTION**

GT.0.0: constant scale factor

LT.0.0: user-defined interaction with axial force. |SFSHT| is the load curve ID giving scale factor as a function of normalized axial force (tensile is positive). The normalization uses SFAT for tensile force and SFAC for compressive force. For example, point (-1.0,0.5) on the curve defines a scale factor of 0.5 for compressive force of -SFAC.

Card 5	1	2	3	4	5	6	7	8
Variable	HARDMS	GAMMS	HARDMT	GAMMT	HARDAT	GAMAT	HARDAC	GAMAC
Type	F	F	F	F	F	F	F	F
Default	0.0	0.0	HARDMS	GAMMS	0.0	0.0	HARDAT	GAMAT

VARIABLE**DESCRIPTION**

HARDMS	Kinematic hardening modulus for moment about the local s -axis (see Remark 8)
GAMMS	Kinematic hardening limit for moment about the local s -axis (see Remark 8)
HARDMT	Kinematic hardening modulus for moment about the local t -axis
GAMMT	Kinematic hardening limit for moment about the local t -axis
HARDAT	Kinematic hardening modulus for tensile axial force
GAMAT	Kinematic hardening limit for tensile axial force
HARDAC	Kinematic hardening modulus for compressive axial force
GAMAC	Kinematic hardening limit for compressive axial force

Card 6	1	2	3	4	5	6	7	8
Variable	OMGMS1	OMGMS2	OMGMT1	OMGMT2	OMGAT1	OMGAT2	OMGAC1	OMGAC2
Type	F	F	F	F	F	F	F	F
Default	0.0	0.0	OMGMS1	OMGMS2	0.0	0.0	OMGAT1	OMGAT2

VARIABLE**DESCRIPTION**

OMGMS1	Damage evolution parameter ω_{s1} for moment about the local s -axis (see Remark 9)
OMGMS2	Damage evolution parameter ω_{s2} for moment about the local s -axis
OMGMT1	Damage evolution parameter ω_{t1} for moment about the local t -axis
OMGMT2	Damage evolution parameter ω_{t2} for moment about the local t -axis
OMGAT1	Damage evolution parameter ω_{at1} for tensile force
OMGAT2	Damage evolution parameter ω_{at2} for tensile force
OMGAC1	Damage evolution parameter ω_{ac1} for compressive force
OMGAC2	Damage evolution parameter ω_{ac2} for compressive force

Card 7	1	2	3	4	5	6	7	8
Variable	RUMS	RUMT	DUAT	DUAC	LAM1	LAM2	SOFT1	SOFT2
Type	F	F	F	F	F	F	F	F
Default	10 ²⁰	RUMS	10 ²⁰	DUAT	0.0	LAM1	3.0	4.0

VARIABLE**DESCRIPTION**

RUMS	Ultimate plastic rotation about s -axis for damage calculation (see Remark 9)
RUMT	Ultimate plastic rotation about t -axis for damage calculation

VARIABLE	DESCRIPTION
DUAT	Ultimate tensile plastic deformation/strain for damage calculation. See IAX above in Card 1 and Remark 9 .
DUAC	Ultimate compressive plastic deformation/strain for damage calculation. See IAX above in Card 1.
LAM1	Damage evolution parameter
LAM2	Damage evolution parameter
SOFT1	Threshold index at which softening starts (see Remark 9) LE.4.0: Threshold index for start of softening, see Cards 8 thru 10 EQ.5.0: Softening and element deletion are disabled.
SOFT2	Threshold index at which the element is fully softened and to be removed (ignored if SOFT1 = 5)

Plastic Rotation Thresholds Card. Define Card 8 only if IFEMA > 0 (see [Remarks 9](#) and [11](#)).

Card 8	1	2	3	4	5	6	7	8
Variable	PRS1	PRS2	PRS3	PRS4	PRT1	PRT2	PRT3	PRT4
Type	F	F	F	F	F	F	F	F
Default	10 ²⁰	2 × 10 ²⁰	3 × 10 ²⁰	4 × 10 ²⁰	PRS1	PRS2	PRS3	PRS4

VARIABLE	DESCRIPTION
PRS1 – PRS4	Plastic rotation thresholds 1 to 4 about s-axis
PRT1 – PRT4	Plastic rotation thresholds 1 to 4 about t-axis

Plastic Axial Strains Threshold Card. Define Card 9 only if IFEMA > 1 (see [Remarks 9](#) and [11](#)).

Card 9	1	2	3	4	5	6	7	8
Variable	TS1	TS2	TS3	TS4	CS1	CS2	CS3	CS4
Type	F	F	F	F	F	F	F	F
Default	10 ²⁰	2 × 10 ²⁰	3 × 10 ²⁰	4 × 10 ²⁰	TS1	TS2	TS3	TS4

VARIABLE**DESCRIPTION**

TS1 – TS4

Tensile plastic axial deformation/strain thresholds 1 to 4

CS1 – CS4

Compressive plastic axial deformation/strain thresholds 1 to 4

Plastic Shear Strains Threshold Card. Define Card 10 only if IFEMA > 2 (see [Remarks 9](#) and [11](#)).

Card 10	1	2	3	4	5	6	7	8
Variable	SS1	SS2	SS3	SS4	ST1	ST2	ST3	ST4
Type	F	F	F	F	F	F	F	F
Default	10 ²⁰	2 × 10 ²⁰	3 × 10 ²⁰	4 × 10 ²⁰	SS1	SS2	SS3	SS4

VARIABLE**DESCRIPTION**

SS1 – SS4

Plastic shear strain thresholds 1 to 4 in the *s*-direction

ST1 – ST4

Plastic shear strain thresholds 1 to 4 in the *t*-direction**Remarks:**

- Plastic Hinge Locations.** Two plastic hinges can be developed at user-specified locations. The default plastic hinge locations are at the ends of the beam element. See [Figure M209-1](#).
- Yield Surface.** Axial/moment interaction is defined according to the setting of ISURF on [Card 1](#) (see also [Remark 4](#)).

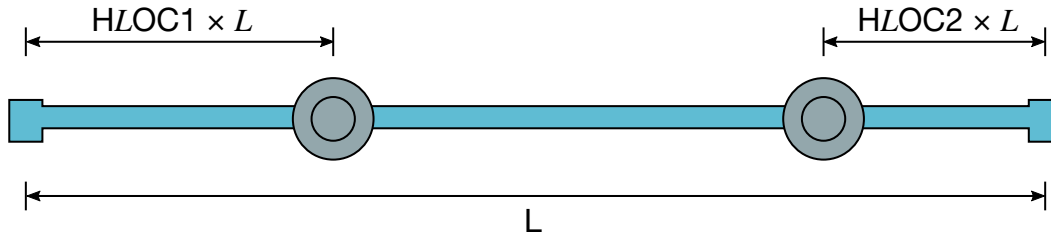

Figure M209-1. Plastic hinge locations for $HLOC1 > 0.0$ and $HLOC2 > 0.0$

a) ISURF = 1 (default, simple power law):

$$\psi = \left| \frac{M_s - m_s}{M_{ys}} \right|^\alpha + \left| \frac{M_t - m_t}{M_{yt}} \right|^\beta + \left| \frac{F - f - F_0}{F_y - F_0} \right|^\gamma - 1$$

b) ISURF = 2 (power law based on resultant moment):

$$\psi = \left[\left(\frac{M_s - m_s}{M_{ys}} \right)^2 + \left(\frac{M_t - m_t}{M_{yt}} \right)^2 \right]^{\frac{\alpha}{2}} + \left| \frac{F - f - F_0}{F_y - F_0} \right|^\gamma - 1$$

c) ISURF = 3 (skew yield surface version of ISURF = 2; see Remark 5):

$$\psi = \left\{ \left[\frac{(M_s - m_s) + \delta_s(F - f - F_0)}{(1 - \delta_s \kappa_s) M_{ys}} \right]^2 + \left[\frac{(M_t - m_t) + \delta_t(F - f - F_0)}{(1 - \delta_t \kappa_t) M_{yt}} \right]^2 \right\}^{\frac{\alpha}{2}} + \left| \frac{(F - f - F_0) + \kappa_s(M_s - m_s) + \kappa_t(M_t - m_t)}{(1 - \delta_s \kappa_s - \delta_t \kappa_t)(F_y - F_0)} \right|^\gamma - 1$$

In the above equations,

Variable	Definition
M_s and M_t	Moments about the s - and t -axes, respectively
F	Axial force
M_{ys} and M_{yt}	Current yield moments
F_y	Current axial yield force, where
	$F_y = \begin{cases} F_{yt} & \text{for } (F - f) \geq F_0 \\ -F_{yc} & \text{for } (F - f) < F_0 \end{cases}$
F_{yt} and F_{yc}	Current tensile and compressive strengths, respectively
m_s, m_t and f	Current moments and forces that determine the center of the yield surface. They are closely related to the Bauschinger effect or kinematic hardening discussed below.

Variable	Definition
$\alpha, \beta,$ and γ	Input parameters ALPHA, BETA, and GAMMA on Card 3 which are real numbers ≥ 1.1 unless ALPHA and BETA are < 0 (see Remark 4)
δ_s and δ_t	Input parameters DELTAS and DELTAT (length units) on Card 4 for skew of yield surface in the local s - and t -directions, respectively
κ_s and κ_t	Input parameters KAPPAS and KAPPAT (1/length units) on Card 4 for skew of yield surface in the local s - and t -directions, respectively
F_0	Input parameter F0 on Card 3 (see Remark 3)

- Force Offset.** The input parameter F0 offsets the yield surface parallel to the axial force axis. It is the axial force at which the maximum bending moment capacity occurs and is treated as tensile if F0 is positive, or compressive if F0 is negative. The same axial force offset F0 is used for both the local axes (s and t). For steel components, the value of F0 is usually zero. For reinforced concrete components, F0 should be input as negative, corresponding to the compressive axial force at which the moment capacities are maximum.

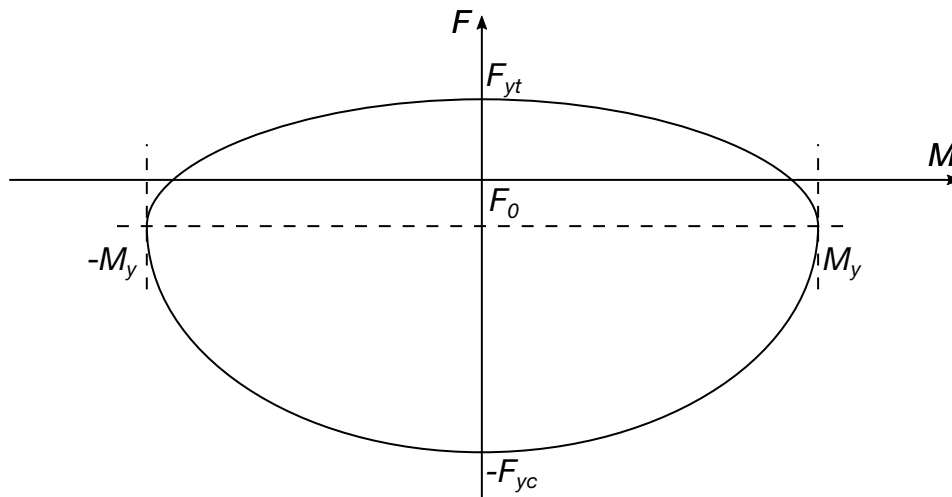

Figure M209-2. Effect of force offset on the yield surface

- User Defined Yield Surface Shape.** Optionally, you may provide curves defining the shape of the axial-moment yield surface. When ALPHA and BETA are less than 0.0 and GAMMA is equal to 0.0, the absolute values of ALPHA and BETA are the IDs of the load curves (see *DEFINE_CURVE) that define the yield loci in M_s - F and M_t - F planes. The program will automatically find the set of parameters ALPHA, BETA, GAMMA, SFS, SFT, SFAT, SFAC, F0, DELTAS,

KAPPAS, DELTAT and KAPPAT that best fits the yield loci and the yield surface type ISURF.

- Skew Yield Surface.** Reinforced concrete sections with asymmetric reinforcement have a skew yield surface, meaning that the bending moment capacities at zero axial force are different in positive and negative bending, and the maximum axial capacity occurs at a nonzero bending moment. Furthermore, the axial load at which maximum biaxial bending moment occurs depends on the angle of the bending axis. This can be modelled with ISURF = 3, where DELTAS and DELTAT control the slope of the line connecting peak tensile and compressive strength vertices, and KAPPAS and KAPPAT control the slope of the line connecting peak moment vertices (which lies in the balance plane).

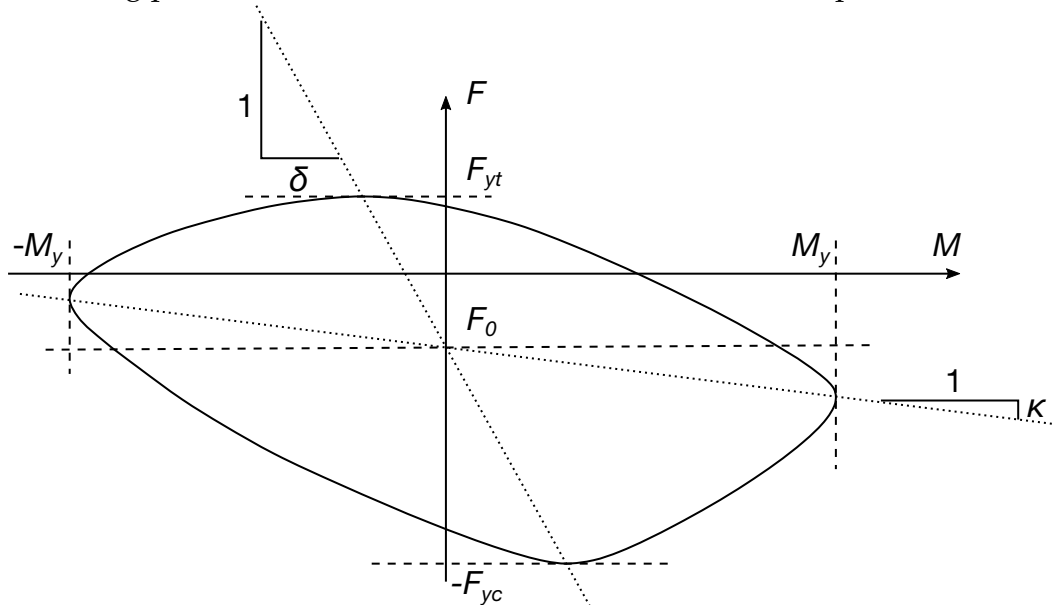

Figure M209-3. Example of a skew yield surface

- Hardening Behavior during Cyclic Deformation (Hysteresis).** The input parameter IHARD determines how the force as a function of deformation and moment as a function of rotation curves on [Card 2](#) are applied during cyclic deformation. In this case, “deformation” includes both axial deformation and rotation at plastic hinges. If IHARD = 1, the abscissa represents cumulative absolute plastic deformation. This quantity is always positive. It increases whenever there is deformation in either direction. Thus, during hysteresis, the yield moments are taken from points in the input curve with increasingly positive deformation. If the curve shows a degrading behavior (reducing strength with deformation), then, once degraded by plastic deformation, the yield force or moment can never recover to its initial value. This option can be described as “fatigue-type” hysteretic behavior, where all plastic cycles contribute to the degradation. In the axial direction, plastic deformation is accumulated separately for tensile and compressive deformations.

If IHARD = 2, 3 or 4, the abscissa represents the peak absolute value of the plastic deformation. This quantity increases only when the absolute value of plastic deformation exceeds the previously recorded maximum. This option can be described as “high-tide” hardening behavior and follows the FEMA approach. In particular, IHARD of 3 and 4 reproduce the yield-oriented and peak-oriented hysteresis, respectively, as shown below.

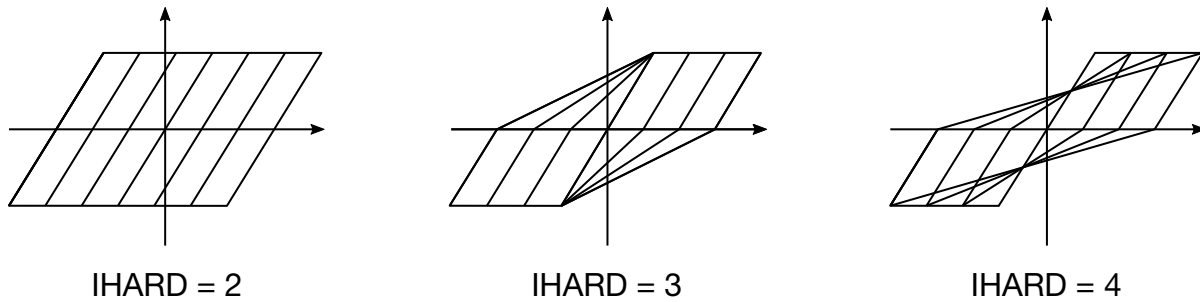

Figure M209-4. Example hardening curves

- 7. **Pinching.** Pinched-shape hysteresis loops are seen in experiments on reinforced concrete members. They are caused by stiffness changes due to cracks opening and closing. This effect on the flexure response may be simulated using input parameter PINM. The default, PINM = 1.0, gives no pinching. The pinch points are given by moments and rotations illustrated in the schematic below. Input parameter PINS has the same effect on shear hysteresis as PINM does on flexure hysteresis. See Figure M209-5.
- 8. **Kinematic Hardening.** Kinematic hardening (Bauschinger effect, whereby an increase in tensile yield strength occurs at the expense of compressive yield strength)

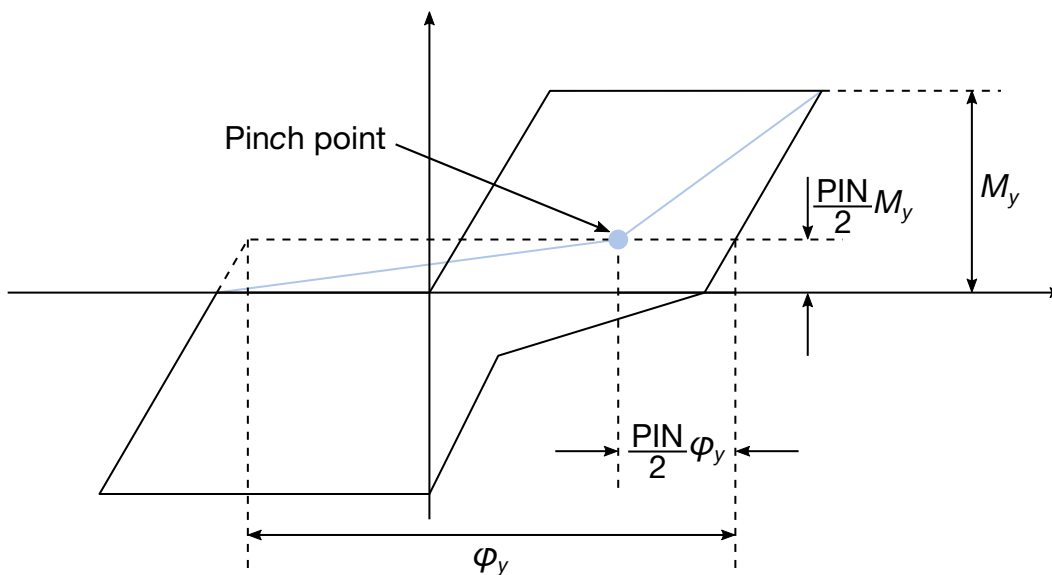

Figure M209-5. Example hysteresis curve with pinch point

strength) is modelled by shift of the yield surface and is controlled by input parameters HARD_{xx} and GAM_{xx}, where xx is MS, MT, AT, and AC for moment about s-axis, moment about t-axis, axial tension and axial compression, respectively. HARD_{xx} is the rate at which the yield surface shifts, in units of force/displacement or force/strain for axial response (depending on the setting of IAX) and in units of moment/rotation for flexure response. GAM_{xx} is defined such that HARD_{xx}/GAM_{xx} is the maximum force or moment by which the yield surface can shift.

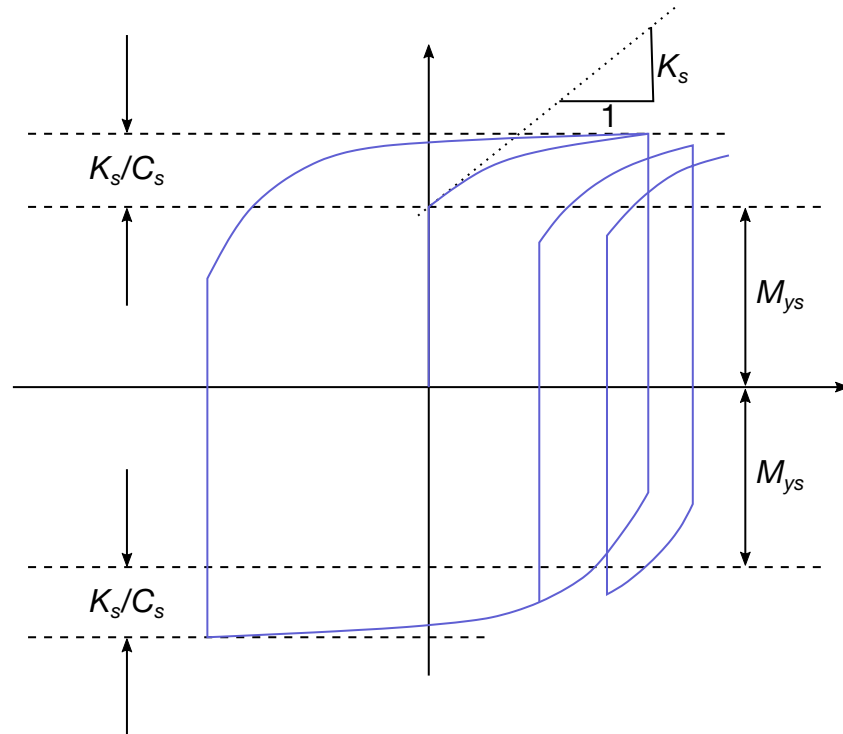

Figure M209-6. Example hysteresis curve with kinematic hardening for the moment about the s-axis. Here K_s is HARD_{MS} and C_s is GAM_{MS}.

9. **Degradation, Damage and Element Erosion.** Stiffness and strength degradation are modelled using a damage approach. The damaged fraction of the material does not contribute to the forces, the moments or the stiffness. Damage is calculated in two stages:
 - a) a single damage parameter based on passing FEMA thresholds, and
 - b) component-specific damage (where “component” means axial tension, axial compression, bending about s-axis and bending about t-axis).

The force or moment for component xx , $F_{xx,actual}$, is calculated as:

$$F_{xx,actual} = (1 - D_{xx})(1 - D_{FEMA})F_{xx, nominal} \cdot$$

xx can be AT for axial tension, AC for axial compression, MS for bending about the s -axis, MT for bending about the t -axis. Here, $F_{xx,nominal}$ is the force or moment calculated in the absence of damage for component xx . D_{xx} is the component-specific damage fraction for component xx , and D_{FEMA} is the damage calculated from passing FEMA thresholds (see [Remark 11](#)).

The component-specific damage may be defined to be dependent on cumulative plastic deformation, on peak deformation, or a combination of both:

$$D_{xx}(t) = 1 - \left[1 - \omega_{1xx} \frac{\Delta_{xx,peak}}{\Delta_{xx,ult}} \right]^{\lambda_1} \left[1 - \omega_{2xx} \frac{\Delta_{xx,accum}}{\Delta_{xx,ult}} \right]^{\lambda_2} .$$

Here ω_{1xx} and ω_{2xx} are the input parameters OMG_{xx1} and OMG_{xx2} . $\Delta_{xx,peak}$ is the peak deformation (i.e., axial displacement, axial strain or rotation depending on xx and IAX) that has occurred to date; $\Delta_{xx,accum}$ is the accumulated plastic deformation; and $\Delta_{xx,ult}$ is the input parameter $DUAT$, $DUAC$, $RUMS$ or $RUMT$. λ_1 and λ_2 are the input parameters $LAM1$ and $LAM2$. Setting these to zero disables dependence on peak deformation and cumulative plastic deformation, respectively.

The damage D_{FEMA} is calculated using input parameters $SOFT1$ and $SOFT2$, taking the most damaged component including shear as well as axial and moment components. For example, if $SOFT1 = 3$ and $SOFT2 = 4$, and the most damaged component has reached a FEMA index of 3.25 (meaning one quarter of the way from threshold 3 to threshold 4), then $D_{FEMA} = 0.25$. When the most damaged component reaches a FEMA index of 4.0, D_{FEMA} reaches zero and the element will be deleted.

By default, $SOFT1 = 3$ and $SOFT2 = 4$. Thus, softening and element removal can occur even if the input parameters $SOFT1$ and $SOFT2$ have not been set by the user. This damage mechanism can be switched off by setting $SOFT1 = 5$. In that case, D_{FEMA} is always zero irrespective of which thresholds are passed, and elements will not be deleted.

10. **Shear Behavior.** Nonlinear shear behavior is controlled using input parameters $LCSHS$, $LCSHT$, $SFSHS$ and $SFSHT$. By default, the shear yield surface is independent of the yield surface for axial and flexure and takes the following form:

$$\psi_s = \left(\frac{V_s}{V_{ys}} \right)^2 + \left(\frac{V_t}{V_{yt}} \right)^2 - 1 .$$

Here, V_s and V_t are the current shear forces in the local s - and t -directions. V_{ys} and V_{yt} are the current yield shear forces in the local s - and t -directions

The shear yield forces are functions of plastic shear strain (that is, shear angle). The plastic shear strain can be either peak or cumulative, depending on $IHARD$.

Optionally, the shear strengths can be user-defined functions of the axial force; this is obtained by setting SFSHS and SFSHT to negative values.

11. **FEMA Thresholds.** FEMA thresholds are used in performance-based earthquake engineering to classify the response according to the level of deformation. The thresholds are the divisions between regimes such as “Elastic”, “Immediate Occupancy”, “Life Safe”, etc. Output parameters indicate the status of each element with respect to these regimes. The thresholds are defined by input parameters $PRSn$, $PRTn$, TSn , CSn , SSn , STn where $n = 1, 2, 3$, and 4 for the different regimes. PRS and PRT are plastic rotation about the s and t axes, TS and CS are tensile and compressive strain or deformation according to the setting of IAX, and SS and ST are shear strains in the s and t directions. The corresponding output parameters, described as “FEMA flags” (see [Remark 12](#)) are “high-tide” values indicating which thresholds have been passed during the analysis, for example 3.25 means that the maximum deformation that has occurred to date exceeds threshold 3 and is one quarter of the way from threshold 3 to threshold 4. See also the influence of SOFT1 and SOFT2 described in [Remark 9](#).
12. **Output.** In addition to the six resultants written for all beam elements, this material model writes a further 50 extra history variables to the d3plot and d3thdt files, given in the table below. The data is written in the same position in these files as where integrated beams write the stresses and strains at integration points requested by BEAMIP on *DATABASE_EXTENT_BINARY. Therefore, some post-processors may interpret this data as if the elements were integrated beams with 10 integration points, and in that case the data may be accessed by selecting the appropriate integration point and data component:

Integration point	1	2	3	4	5	6	7	8	9	10	
Extra (history) variable	1	6	11	16	21	26	31	36	41	46	XX(RR) axial stress
	2	7	12	17	22	27	32	37	42	47	XY(RS) shear stress
	3	8	13	18	23	28	33	38	43	48	ZX(TR) shear stress
	4	9	14	19	24	29	34	39	44	49	EPS
	5	10	15	20	25	30	35	40	45	50	XX(RR) axial strain

For example, extra history variable 16 is located at the position that would normally be XX(RR) axial stress for integration point 4.

Extra Variable	Description
1	Total axial deformation/strain
2	Hysteretic bending energy at plastic Hinge 1
3	Hysteretic bending energy at plastic Hinge 2

Extra Variable	Description
4	Plastic rotation about s -axis at Hinge 1
5	Plastic rotation about s -axis at Hinge 2
6	Plastic rotation about t -axis at Hinge 1
7	Plastic rotation about t -axis at Hinge 2
8	Bending moment about s -axis at node 1
9	Bending moment about s -axis at node 2
10	Bending moment about t -axis at node 1
11	Bending moment about t -axis at node 2
12	Hysteretic axial deformation energy
13	Internal energy
14	N/A
15	Axial plastic deformation
16	FEMA rotation flag
17	Current utilization
18	Peak utilization
19	FEMA shear flag
20	FEMA axial flag
21	Peak plastic tensile axial deformation/strain
22	Peak plastic compressive axial deformation/strain
23	Peak plastic rotation about s -axis at Hinge 1
24	Peak plastic rotation about s -axis at Hinge 2
25	Peak plastic rotation about t -axis at Hinge 1
26	Peak plastic rotation about t -axis at Hinge 2

Extra Variable	Description
27	Cumulative plastic tensile axial deformation/strain
28	Cumulative plastic compressive axial deformation/strain
29	Cumulative plastic rotation about <i>s</i> -axis at Hinge 1
30	Cumulative plastic rotation about <i>s</i> -axis at Hinge 2
31	Cumulative plastic rotation about <i>t</i> -axis at Hinge 1
32	Cumulative plastic rotation about <i>t</i> -axis at Hinge 2
33	Axial tensile damage
34	Axial compressive damage
35	Flexural damage about <i>s</i> -axis at Hinge 1
36	Flexural damage about <i>s</i> -axis at Hinge 2
37	Flexural damage about <i>t</i> -axis at Hinge 1
38	Flexural damage about <i>t</i> -axis at Hinge 2
39	Plastic shear strain in <i>s</i> -direction
40	Plastic shear strain in <i>t</i> -direction
41	Peak plastic shear strain in <i>s</i> -direction
42	Peak plastic shear strain in <i>t</i> -direction
43	Cumulative plastic shear strain in <i>s</i> -direction
44	Cumulative plastic shear strain in <i>t</i> -direction
45	Current axial-flexural utilization at Hinge 1
46	Peak axial-flexural utilization at Hinge 1
47	Current axial-flexural utilization at Hinge 2
48	Peak axial-flexural utilization at Hinge 2
49	Current shear utilization

Extra Variable

Description

50

Peak shear utilization

*MAT_SPR_JLR

This is Material Type 211. This material model was written for Self-Piercing Rivets (SPR) connecting aluminum sheets. Each SPR should be modelled by a single hexahedral (8-node solid) element, fixed to the sheet either by direct meshing or by tied contact. Pre- and post-processing methods are the same as for solid-element spotwelds using *MAT_SPOTWELD. On *SECTION_SOLID, set ELFORM = 1.

Card 1	1	2	3	4	5	6	7	8
Variable	MID	RO	E	PR	HELAS	TELAS		
Type	A8	F	F	F	F	F		
Default	none	none	none	none	0.0	0.0		

Cards 2 and 3 define "Head" end of SPR inputs

Card 2	1	2	3	4	5	6	7	8
Variable	LCAXH	LCSHH	LCBMH	SFAXH	SFSHH	SFBMH		
Type	I	I	I	F	F	F		
Default	none	none	none	1.0	1.0	1.0		

Card 3	1	2	3	4	5	6	7	8
Variable	DFAKH	DFSHH	RFBMH	DMFAXH	DMFSHH	DMFBMH		
Type	F	F	F	F	F	F		
Default	Rem 13	Rem 13	Rem 13	0.1	0.1	0.1		

Cards 4 and 5 define "Tail" end of SPR inputs

Card 4	1	2	3	4	5	6	7	8
Variable	LCAXT	LCSHT	LCBMT	SFAXT	SFSHT	SBFMT		
Type	F	F	F	F	F	F		
Default	none	none	none	1	1	1		

Card 5	1	2	3	4	5	6	7	8
Variable	DFAXT	DFSHT	RFBMT	DFMAXT	DMFSHT	DMFBMT		
Type	F	F	F	F	F	F		
Default	Rem 13	Rem 13	Rem 13	0.1	0.1	0.1		

VARIABLE**DESCRIPTION**

MID	Material identification. A unique number or label not exceeding 8 characters must be specified.
RO	Mass density
E	Young's modulus, used only for contact stiffness calculation.
PR	Poisson's ratio, used only for contact stiffness calculation.
HELAS	SPR head end behavior flag: EQ.0.0: nonlinear EQ.1.0: elastic (use first two points of the load curves).
TELAS	SPR tail end behavior flag: EQ.0.0: nonlinear EQ.1.0: elastic (use first two points of the load curves).
LCAXH	Load curve ID (see *DEFINE_CURVE) giving axial force as a function of deformation (head)

VARIABLE	DESCRIPTION
LCSHH	Load curve ID (see *DEFINE_CURVE) giving shear force as a function of deformation (head)
LCBMH	Load curve ID, see *DEFINE_CURVE, giving moment as a function of rotation (head)
SFAXH	Scale factor on axial force from curve LCAXH
SFSHH	Scale factor on shear force from curve LCSHH
SFBMH	Scale factor on bending moment from curve LCBMH
DFAXH	Optional displacement to start of softening in axial load (head)
DFSHH	Optional displacement to start of softening in shear load (head)
RFBMH	Optional rotation (radians) to start of bending moment softening (head)
DMFAXH	Scale factor on DFAXH
DMFSHH	Scale factor on DFSHH
DMFBMH	Scale factor on RFBMH
LCAXT	Load curve ID (see *DEFINE_CURVE) giving axial force as a function of deformation (tail)
LCSHT	Load curve ID (see *DEFINE_CURVE) giving shear force as a function of deformation (tail)
LCBMT	Load curve ID (see *DEFINE_CURVE) giving moment as a function of rotation (tail)
SFAXT	Scale factor on axial force from curve LCAXT
SFSHT	Scale factor on shear force from curve LCSHT
SFBMT	Scale factor on bending moment from curve LCBMT
DFAXT	Optional displacement to start of softening in axial load (tail)
DFSHT	Optional displacement to start of softening in shear load (tail)
RFBMT	Optional rotation (radians) to start of bending moment softening (tail)

VARIABLE	DESCRIPTION
DMFAXT	Scale factor on DFAXT
DMFSHT	Scale factor on FFSHT
DMFBMT	Scale factor on RFBMT

Remarks:

1. **SPR Geometry.** “Head” is the end of the SPR that fully perforates a sheet. “Tail” is the end that is embedded within the thickness of a sheet.

The sheet planes are defined at the head by the quadrilateral defined by nodes N1-N2-N3-N4 of the solid element; and at the tail by the quadrilateral defined by nodes N5-N6-N7-N8. It is essential that the nodes N1 to N4 are fixed to the head sheet (e.g. by direct meshing or tied contact): the element has no stiffness to resist relative motion of nodes N1 to N4 in the plane of the head sheet. Similarly, nodes N5 to N8 must be fixed to the tail sheet

The tail of the SPR is defined as a point in the tail sheet plane, initially at the center of the element face. The head of the SPR is initially at the center of the head sheet plane. The SPR axis is defined as the line joining the tail to the head. Thus, the axis of the SPR would typically be coincident with the solid element local z-axis if the solid is a cuboid. It is the user’s responsibility to ensure that each solid element is oriented correctly.

During the analysis, the head and tail will always remain in the plane of the sheet but may move away from the centers of the sheet planes if the shear forces in these planes are sufficient.

2. **Young’s Modulus and Poisson’s Ratio.** E and PR are used only to calculate contact stiffness. They are not used by the material model.
3. **Axes.** Deformation is in length units and is on the *x*-axis. Force is on the *y*-axis. Rotation is in radians on the *x*-axis. Moment is on the *y*-axis.
4. **Load Curve Assumptions.** All the load curves are expected to start at (0,0). “Deformation” means the total deformation including both elastic and plastic components, similarly for rotation.
5. **“High Tide” Algorithm.** A “high tide” algorithm is used to determine the deformation or rotation to be used as the *x*-axis of the load curves when looking up the current yield force or moment. The “high tide” is the greatest displacement or rotation that has occurred so far during the analysis.

6. **Elastic Stiffness.** The first two points of the load curve define the elastic stiffness, which is used for unloading.
7. **HELAS and TELAS.** If HELAS > 0, the remainder of the head load curves after the first two points is ignored and no softening or failure occurs. The same applies for TELAS and the tail load curves.
8. **Deformation and Rotation of the SPR.** Axial deformation is defined as change of length of the line between the tail and head of the SPR. This line also defines the direction in which the axial force is applied.

Shear deformation is defined as motion of the tail and head points, in the sheet planes. This deformation is not necessarily perpendicular to axial deformation. Shear forces in these planes are controlled by the load curves LCSHT and LCSHH.

Rotation at the tail is defined as rotation of the tail-to-head line relative to the normal of the tail sheet plane; and for the head, relative to the normal of the head sheet plane.

9. **Element Formulation.** Although ELFORM = 1 is used in the input data, *MAT_SPR_JLR is really a separate unique element formulation. The usual stress/force and hourglass calculations are bypassed, and deformations and nodal forces are calculated by a method unique to *MAT_SPR_JLR; for example, a single *MAT_SPR_JLR element can carry bending loads.
10. **Hourglass.** *HOURGLASS inputs are irrelevant to *MAT_SPR_JLR.
11. **SWFORC file.** Output to the swforc file works in the same way as for spotwelds. Although inside the material model the load curves LCSHT and LCSHH control “shear” forces in the sheet planes, in the swforc file the quoted shear force is the force normal to the axis of the SPR.
12. **Softening.** Before an element fails, it enters a “softening” regime in which the forces, moments and stiffnesses are ramped down as displacement increases (this avoids sudden shocks when the element is deleted). For example, for axial loading at the head, softening begins when the maximum axial displacement exceeds DFAXH. As the displacement increases beyond that point, the load curve will be ignored for that deformation component. The forces, moments and stiffnesses are ramped down linearly with increasing displacement and reach zero at displacement = DFAXH × (1 + DMFAXH) when the element is deleted. The softening factor scales all the force and moment components at both head and tail. Thus, all the force and moment components are reduced when any one displacement component enters the softening regime. For example, if DFAXT = 3.0mm, and DMFAXT = 0.1, then softening begins when axial displacement of the tail reaches 3.0 mm and final failure occurs at 3.3 mm.

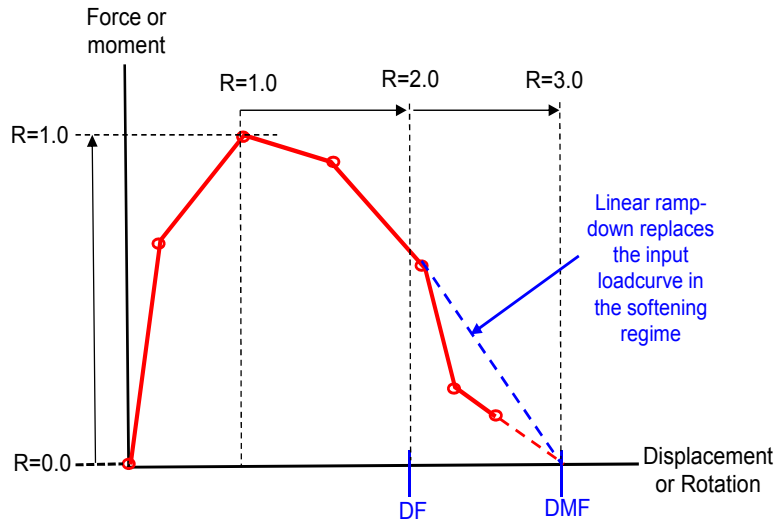

Figure [M211-1]. Output variable “displacement ratio” (or rotation ratio for bending)

- 13. **Initial Softening Displacements/Rotations.** If the inputs DFAXH, DFSHH, RFBMH, DFAXT, DFSHT, and RFBMT are non-zero, these values must be within the abscissa values of the relevant curve, such that the curve force/moment value is greater than zero at the defined start of softening.

If the inputs are left blank or zero, they will be calculated internally as follows:

- a) Final failure will occur at the displacement or rotation (DFAIL) at which the load curve reaches zero (determined, if necessary, by extrapolation from the last two points).
 - b) Displacement or rotation at which softening begins is then back-calculated. For example, $DFAXT = DF_{FAIL} / (1 + DMGAXT)$.
 - c) If DMGAXT is left blank or zero, it defaults to 0.1.
 - d) If the load curve does not drop to zero, and the final two points have a zero or positive gradient, no failure or softening will be caused by that displacement component.
- 14. **Output Stress.** Output stresses (in the d3plot and time-history output files) are set to zero.
 - 15. **Displacement Ratio.** The output variable “displacement ratio” (or rotation ratio for bending), R , is defined as follows. See also the [Figure M211-1](#).
 - a) $R = 0.0$ to 1.0 . The maximum force or moment on the input curve has not yet been reached. R is proportional to the maximum force or moment

reached so far, with 1.0 being the point of maximum force or moment on the input curve.

- b) $R = 1.0$ to 2.0 . The element has passed the point of maximum force but has not yet entered the softening regime. R rises linearly with displacement (or rotation) from 1.0 when maximum force occurs to 2.0 when softening begins.
- c) $R = 2.0$ to 3.0 . Softening is occurring. R rises linearly with displacement from 2.0 at the onset of softening to 3.0 when the element is deleted.

The displacement (or rotation) ratio is calculated separately for axial, shear and bending at the tail and head (see [Remark 16](#) below). The output listed by post-processors as “plastic strain” is actually the maximum displacement or rotation ratio of any displacement or rotation component at head or tail. This same variable is also output as “Failure” in the spotweld data in the `swforc` file (or the `swforc` section of the `binout` file).

16. **Additional History Variables.** The additional history variables are listed in the table below.

History Variable #	Description
1	Failure time (used for <code>swforc</code> file)
2	Softening factor used internally to prevent abrupt failure.
3	Displacement ratio – axial, head
4	Displacement ratio – axial, tail
5	Displacement ratio – shear, head
6	Displacement ratio – shear, tail
7	Rotation ratio – bending, head
8	Rotation ratio – bending, tail
9	Used for <code>swforc</code> output
10	Shear force in “beam” x -axis
11	Shear force in “beam” y -axis

History Variable #	Description
12	Axial force in "beam" z-axis (along "beam")
13	Moment about "beam" x-axis at head
14	Moment about "beam" y-axis at head
15	Moment about "beam" z-axis at head (torsion – should be zero)
16	"Beam" length
17	Moment about "beam" x-axis at tail
18	Moment about "beam" y-axis at tail
19	Moment about "beam" z-axis at tail (torsion – should be zero)
20	Isoparametric coordinate of head of "beam" (s)
21	Isoparametric coordinate of head of "beam" (t)
22	Isoparametric coordinate of tail of "beam" (s)
23	Isoparametric coordinate of tail of "beam" (t)
24	Timestep
25	Plastic displacement – axial, head
26	Plastic displacement – axial, tail
27	Plastic rotation – head
28	Plastic rotation – tail
29	Plastic displacement – shear in sheet axes, head
30	Plastic displacement – shear in sheet axes, tail
31	Global x -component of the "beam" x -axis
32	Global y -component of the "beam" x -axis
33	Global z -component of the "beam" x -axis

History Variable #	Description
34	Shear displacement – local x -axis, head
35	Shear displacement – local y -axis, head
36	Shear displacement – local x -axis, tail
37	Shear displacement – local y -axis, tail
38	Total displacement – axial
39	Current rotation (radians) – head, local x -axis
40	Current rotation (radians) – head, local y -axis
41	Current rotation (radians) – tail, local x -axis
42	Current rotation (radians) – tail, local y -axis

***MAT_COMPOSITE_TABULATED_PLASTICITY_DAMAGE**

This is Material Type 213, an orthotropic elasto-plastic material, with temperature and strain rate dependence. It is based on [1, 2, 3, 4, 5, 7, 8, 9] and is available for solid and thin shell elements. The material is under development.

Card Summary:

Card 1. This card is required.

MID	RO	EA	EB	EC	PRBA	PRCA	PRCB
-----	----	----	----	----	------	------	------

Card 2. This card is required.

GAB	GBC	GCA	PTOL	AOPT	MACF	FILT	VEVP
-----	-----	-----	------	------	------	------	------

Card 3. This card is required.

XP	YP	ZP	A1	A2	A3		
----	----	----	----	----	----	--	--

Card 4. This card is required.

V1	V2	V3	D1	D2	D3	BETA	TCSYM
----	----	----	----	----	----	------	-------

Card 5. This card is required.

H11	H22	H33	H12	H23	H13	H44	H55
-----	-----	-----	-----	-----	-----	-----	-----

Card 6. This card is required.

H66	LT1	LT2	LT3	LT4	LT5	LT6	LT7
-----	-----	-----	-----	-----	-----	-----	-----

Card 7. This card is required.

LT8	LT9	LT10	LT11	LT12	YSC	DFLAG	DC
-----	-----	------	------	------	-----	-------	----

Card 8a.1. This card is included if FTYPE = 0.

FTYPE							
-------	--	--	--	--	--	--	--

Card 8a.2. This card must be included as a blank line if FTYPE = 0.

--	--	--	--	--	--	--	--

Card 8b.1. This card is included if FTYPE = 1 (Puck Failure Criterion).

FTYPE	FV0	FV1	FV2	FV3	FV4	FV5	FV6
-------	-----	-----	-----	-----	-----	-----	-----

Card 8b.2. This card is included if FTYPE = 1 (Puck Failure Criterion).

FV7	FV8	FV9	FV10	FV11	FV12	FV13	FV14
-----	-----	-----	------	------	------	------	------

Card 8c.1. This card is included if FTYPE = 2 (Tsai-Wu Failure Criterion).

FTYPE		FV1	FV2	FV3	FV4	FV5	FV6
-------	--	-----	-----	-----	-----	-----	-----

Card 8c.2. This card is included if FTYPE = 2. (Tsai-Wu Failure Criterion).

FV7	FV8	FV9	FV10	FV11	FV12		
-----	-----	-----	------	------	------	--	--

Card 8d.1. This card is included if FTYPE = 3 (Generalized Tabulated Failure Criterion).

FTYPE		FV1	FV2	FV3			
-------	--	-----	-----	-----	--	--	--

Card 8d.2. This card is included as a blank line if FTYPE = 3 (Generalized Tabulated Failure Criterion).

--	--	--	--	--	--	--	--

Card 9. BETA values only need to be specified when V EVP = 1 or 2.

BETA11	BETA22	BETA33	BETA44	BETA55	BETA66	BETA12	BETA23
--------	--------	--------	--------	--------	--------	--------	--------

Card 10. BETA values only need to be specified when V EVP = 1 or 2.

BETA13	CP	TQC	TEMP	PMACC			
--------	----	-----	------	-------	--	--	--

Data Card Definitions:

Card 1	1	2	3	4	5	6	7	8
Variable	MID	RO	EA	EB	EC	PRBA	PRCA	PRCB
Type	A	F	F	F	F	F	F	F
Default	none	none	none	none	none	none	none	none

VARIABLE

DESCRIPTION

MID

Material identification. A unique number or label must be specified (see *PART).

VARIABLE	DESCRIPTION
RO	Mass density
EA	E_a , Young's modulus in the a -direction
EB	E_b , Young's modulus in the b -direction
EC	E_c , Young's modulus in the c -direction
PRBA	ν_{ba} , (elastic) Poisson's ratio, ba (see Remark 9)
PRCA	ν_{ca} , (elastic) Poisson's ratio, ca (see Remark 9)
PRCB	ν_{cb} , (elastic) Poisson's ratio, cb (see Remark 9)

Card 2	1	2	3	4	5	6	7	8
Variable	GAB	GBC	GCA	PTOL	AOPT	MACF	FILT	VEVP
Type	F	F	F	F	F	I	F	I
Default	none	none	none	10^{-6}	0.0	0	0.0	0

VARIABLE	DESCRIPTION
GAB	G_{ab} , shear modulus ab -plane
GBC	G_{bc} , shear modulus bc -plane
GCA	G_{ca} , shear modulus ca -plane
PTOL	Yield function tolerance used during plastic multiplier calculations
AOPT	Material axes option (see <code>MAT_OPTIONTROPIC_ELASTIC</code> for a more complete description): <p>EQ.0.0: Locally orthotropic with material axes determined by element nodes. For shells only, the material axes are then rotated about the normal vector to the surface of the shell by the angle BETA.</p> <p>EQ.1.0: Locally orthotropic with material axes determined by a point, P, in space and the global location of the element center. This option is for solid elements only.</p>

VARIABLE	DESCRIPTION
	<p>EQ.2.0: Globally orthotropic with material axes determined by vectors defined below</p> <p>EQ.3.0: Locally orthotropic material axes determined by a vector \mathbf{v} and the normal vector to the plane of the element. The plane of a solid element is the midsurface between the inner surface and outer surface defined by the first four nodes and the last four nodes of the connectivity of the element, respectively. Thus, for solid elements, AOPT = 3 is only available for hexahedrons. \mathbf{a} is determined by taking the cross product of \mathbf{v} with the normal vector, \mathbf{b} is determined by taking the cross product of the normal vector with \mathbf{a}, and \mathbf{c} is the normal vector. Then \mathbf{a} and \mathbf{b} are rotated about \mathbf{c} by an angle BETA. BETA may be set in the keyword input for the element or in the input for this keyword. Note that for solids, the material axes may be switched depending on the choice of MACF. The switch may occur before or after applying BETA depending on the value of MACF.</p> <p>EQ.4.0: Locally orthotropic in cylindrical coordinate system with the material axes determined by a vector, \mathbf{v}, and an originating point, P, defining the centerline axis. This option is for solid elements only.</p> <p>LT.0.0: The absolute value of AOPT is a coordinate system ID number (CID on *DEFINE_COORDINATE_NODES, *DEFINE_COORDINATE_SYSTEM or *DEFINE_COORDINATE_VECTOR).</p>
MACF	<p>Material axes change flag for solid elements:</p> <p>EQ.-4: Switch material axes b and c before BETA rotation</p> <p>EQ.-3: Switch material axes a and c before BETA rotation</p> <p>EQ.-2: Switch material axes a and b before BETA rotation</p> <p>EQ.1: No change, default</p> <p>EQ.2: Switch material axes a and b after BETA rotation</p> <p>EQ.3: Switch material axes a and c after BETA rotation</p> <p>EQ.4: Switch material axes b and c after BETA rotation</p>

Figure M2-2 indicates when LS-DYNA applies MACF during the process to obtain the final material axes. If BETA on *ELEMENT_SOLID_{OPTION} is defined, then that BETA is used for the rotation for all AOPT options. Otherwise, if AOPT = 3, the BETA input

VARIABLE	DESCRIPTION
-----------------	--------------------

on Card 4 rotates the axes. For all other values of AOPT, the material axes will be switched as specified by MACF, but no BETA rotation will be performed.

FILT Factor for strain rate filtering (optional):

$$\dot{\epsilon}_{i+1}^{avg} = (1 - \text{FILT}) \times \dot{\epsilon}_{i+1}^{cur} + \text{FILT} \times \dot{\epsilon}_i^{avg}$$

where i is the previous time step. The value of FILT is between 0 and 1

VEVP Flag to control viscoelastic, viscoplastic behavior:

EQ.0: Viscoplastic only with no rate effects in elastic region (default)

EQ.1: Viscoelastic, viscoplastic (see Cards 9 and 10)

EQ.2: Viscoelastic only (see Cards 9 and 10)

Card 3	1	2	3	4	5	6	7	8
Variable	XP	YP	ZP	A1	A2	A3		
Type	F	F	F	F	F	F		
Default	0.0	0.0	0.0	0.0	0.0	0.0		

VARIABLE	DESCRIPTION
-----------------	--------------------

XP, YP, ZP Coordinates of point P for AOPT = 1 and 4

A1, A2, A3 Components of vector \mathbf{a} for AOPT = 2

Card 4	1	2	3	4	5	6	7	8
Variable	V1	V2	V3	D1	D2	D3	BETA	TCSYM
Type	F	F	F	F	F	F	F	I
Default	0.0	0.0	0.0	0.0	0.0	0.0	0.0	0

VARIABLE	DESCRIPTION
V1, V2, V3	Components of vector v for AOPT = 3 and 4
D1, D2, D3	Components of vector d for AOPT = 2
BETA	Angle in degrees of a material rotation about the c-axis, available for AOPT = 0 (shells only) and AOPT = 3 (all element types). This angle may be overridden on the element card; see *ELEMENT_SHELL_BETA and *ELEMENT_SOLID_ORTHO.
TCSYM	<p>Flag for handling tension-compression asymmetry in all three material directions:</p> <p>EQ.0: Do not adjust user-defined data.</p> <p>EQ.1: Compute and use average of tension and compression elastic moduli in adjusting the stress-strain curve. See Remark 7.</p> <p>EQ.2: Use compression modulus as user-defined tension modulus in adjusting the stress-strain curve. See Remark 7.</p> <p>EQ.3: Use tension modulus as user-defined compression modulus in adjusting the stress-strain curve. See Remark 7.</p> <p>EQ.4: Use user-defined tensile curve as the compressive curve overriding the user-defined compressive curve. This implies that the normal stress-strain curves are symmetric including yield values.</p> <p>EQ.5: Use user-defined compressive curve as the tensile curve overriding the user-defined tensile curve. This implies that the normal stress-strain curves are symmetric including yield values.</p>

Card 5	1	2	3	4	5	6	7	8
Variable	H11	H22	H33	H12	H23	H13	H44	H55
Type	F	F	F	F	F	F	F	F
Default	none	none	none	none	none	none	3.0	3.0

VARIABLE	DESCRIPTION
----------	-------------

<i>Hij</i>	Plastic flow rule coefficients. See Remark 1 .
------------	--

Card 6	1	2	3	4	5	6	7	8
Variable	H66	LT1	LT2	LT3	LT4	LT5	LT6	LT7
Type	F	I	I	I	I	I	I	I
Default	3.0	none	none	none	none	none	none	none

VARIABLE	DESCRIPTION
----------	-------------

<i>Hij</i>	Plastic flow rule coefficients. See Remark 1 .
------------	--

LT1	Table ID for a three-dimensional table (see *DEFINE_TABLE_3D) containing temperature and stress-strain input curves for the <i>a</i> -direction tension test. See Remarks 2, 8 and 9 .
-----	--

LT2	Table ID for a three-dimensional table (see *DEFINE_TABLE_3D) containing temperature and stress-strain input curves for the <i>b</i> -direction tension test. See Remarks 2, 8 and 9 .
-----	--

LT3	Table ID for a three-dimensional table (see *DEFINE_TABLE_3D) containing temperature and stress-strain input curves for the <i>c</i> -direction tension test. See Remarks 2, 8 and 9 . Not required if used with shell elements.
-----	--

LT4	Table ID for a three-dimensional table (see *DEFINE_TABLE_3D) containing temperature and stress-strain input curves for the <i>a</i> -direction compression test. See Remarks 2, 8 and 9 .
-----	--

LT5	Table ID for a three-dimensional table (see *DEFINE_TABLE_3D) containing temperature and stress-strain input curves for the <i>b</i> -direction compression test. See Remarks 2, 8 and 9 .
-----	--

LT6	Table ID for a three-dimensional table (see *DEFINE_TABLE_3D) containing temperature and stress-strain input curves for the <i>c</i> -direction compression test. See Remarks 2, 8 and 9 . Not required if used with shell elements.
-----	--

LT7	Table ID for a three-dimensional table (see *DEFINE_TABLE_3D) containing temperature and stress-strain input curves for the <i>ab</i> -
-----	---

VARIABLE**DESCRIPTION**

plane shear test. See [Remarks 2, 8 and 9](#).

Card 7	1	2	3	4	5	6	7	8
Variable	LT8	LT9	LT10	LT11	LT12	YSC	DFLAG	DC
Type	I	I	I	I	I	I	F	I
Default	none	none	none	none	none	none	0.0	none

VARIABLE**DESCRIPTION**

LT8	Table ID for a three-dimensional table (see *DEFINE_TABLE_3D) containing temperature and stress-strain input curves for the <i>bc</i> -plane shear test. See Remarks 2, 8 and 9 . Not required if used with shell elements.
LT9	Table ID for a three-dimensional table (see *DEFINE_TABLE_3D) containing temperature and stress-strain input curves for the <i>ac</i> -plane shear test. See Remarks 2, 8 and 9 . Not required if used with shell elements.
LT10	Table ID for a three-dimensional table (see *DEFINE_TABLE_3D) containing temperature and stress-strain input curves for the 45° off axis <i>ab</i> -plane tension or compression test. See Remarks 2, 8 and 9 . Optional if used with shell elements.
LT11	Table ID for a three-dimensional table (see *DEFINE_TABLE_3D) containing temperature and stress-strain input curves for the 45° off axis <i>bc</i> -plane tension or compression test. See Remarks 2, 8 and 9 . Not required if used with shell elements.
LT12	Table ID for a three-dimensional table (see *DEFINE_TABLE_3D) containing temperature and stress-strain input curves for the 45° off axis <i>ac</i> -plane tension or compression test. See Remarks 2, 8 and 9 . Not required if used with shell elements.
YSC	Load curve ID containing the stress-strain curve IDs and associated initial yield strain values. See Remark 3 .

VARIABLE	DESCRIPTION
DFLAG	Damage formulation flag (see Remark 12): EQ.0: Based on total stress in effective space (default) EQ.1: Based on corrected plastic strain
DC	Curve ID that specifies which components of the damage model are active. It contains the damage parameter ID and the corresponding damage as a function of total strain curve ID. Set this value to zero if damage should not be included in the analysis. See Remark 4 .

No Failure Card. The following two cards are included if FTYPE = 0. Card 8a.2 must be included as a blank line

Card 8a.1	1	2	3	4	5	6	7	8
Variable	FTYPE							
Type	I							

Card 8a.2	1	2	3	4	5	6	7	8
Variable								
Type								

VARIABLE	DESCRIPTION
FTYPE	Failure criterion type (see Remarks 5 and 6): EQ.0: No failure considered (default) EQ.1: Puck Failure Criterion (PFC) (solid elements only) EQ.2: Tsai-Wu Failure Criterion (TWFC) (solid elements only) EQ.3: Generalized Tabulated Failure Criterion (GTFC)

PFC Card. The following two cards are included if FTYPE = 1.

Card 8b.1	1	2	3	4	5	6	7	8
Variable	FTYPE	FV0	FV1	FV2	FV3	FV4	FV5	FV6
Type	I	F	F	F	F	F	F	F

Card 8b.2	1	2	3	4	5	6	7	8
Variable	FV7	FV8	FV9	FV10	FV11	FV12	FV13	FV14
Type	F	F	F	F	F	F	F	F

VARIABLE**DESCRIPTION**

FTYPE	Failure criterion type (see Remarks 5 and 6): EQ.0: No failure considered (default) EQ.1: Puck Failure Criterion (PFC) (solid elements only) EQ.2: Tsai-Wu Failure Criterion (TWFC) (solid elements only) EQ.3: Generalized Tabulated Failure Criterion (GTFC)
FV0	Γ_f , fiber mode fracture energy (<i>a</i> -direction)
FV1	Post-peak residual damage in the <i>a</i> -direction for tension. Value must be a real number between 0 and 1.
FV2	Post-peak residual damage in the <i>a</i> -direction for compression. Value must be a real number between 0 and 1.
FV3	Post-peak residual damage in the <i>b</i> and <i>c</i> -directions for tension. Value must be a real number between 0 and 1.
FV4	Post-peak residual damage in the <i>b</i> and <i>c</i> -directions for compression. Value must be a real number between 0 and 1.
FV5	Post-peak residual damage in shear. Value must be a real number between 0 and 1.
FV6	magnification factor, m_f

VARIABLE	DESCRIPTION
FV7	Slope parameter, p_{ba}^t
FV8	Slope parameter, p_{ba}^c
FV9	Slope parameter, p_{bb}^t
FV10	Slope parameter, p_{bb}^c
FV11	Fiber Poisson's ratio, ν_{ab}^f
FV12	Fiber Young's modulus, E_a^f
FV13	Inter-fiber mode I fracture energy, Γ_1
FV14	Inter-fiber mode II fracture energy, Γ_2

TWFC Card. The following two cards are included if FTYPE = 2.

Card 8c.1	1	2	3	4	5	6	7	8
Variable	FTYPE		FV1	FV2	FV3	FV4	FV5	FV6
Type	I		F	F	F	F	F	F

Card 8c.2	1	2	3	4	5	6	7	8
Variable	FV7	FV8	FV9	FV10	FV11	FV12		
Type	F	F	F	F	F	F		

VARIABLE	DESCRIPTION
FTYPE	Failure criterion type (see Remarks 5 and 6): EQ.0: No failure considered (default) EQ.1: Puck Failure Criterion (PFC) (solid elements only) EQ.2: Tsai-Wu Failure Criterion (TWFC) (solid elements only) EQ.3: Generalized Tabulated Failure Criterion (GTFC)
FV1	$\hat{\sigma}_{aa}^T$ tensile failure stress in the a -direction

VARIABLE	DESCRIPTION
FV2	$\hat{\sigma}_{aa}^C$, compressive failure stress in the a -direction (input as a positive value)
FV3	$\hat{\sigma}_{bb}^T$, tensile failure stress in the b -direction
FV4	$\hat{\sigma}_{bb}^C$, compressive failure stress in the b -direction (input as a positive value)
FV5	$\hat{\sigma}_{cc}^T$, tensile failure stress in the c -direction
FV6	$\hat{\sigma}_{cc}^C$, compressive failure stress in the c -direction (input as a positive value)
FV7	$\hat{\sigma}_{ab}$, shear failure stress in the ab -plane
FV8	$\hat{\sigma}_{bc}$, shear failure stress in the bc -plane
FV9	$\hat{\sigma}_{ac}$, shear failure stress in the ac -plane
FV10	$\hat{\sigma}_{ab}^{45}$, failure stress in the 45° off axis ab -plane
FV11	$\hat{\sigma}_{bc}^{45}$, failure stress in the 45° off axis bc -plane
FV12	$\hat{\sigma}_{ac}^{45}$, failure stress in the 45° off axis ac -plane

GTFC Card. The following two cards are included if FTYPE = 3. Card 8d.2 must be included as a blank line.

Card 8d.1	1	2	3	4	5	6	7	8
Variable	FTYPE		FV1	FV2	FV3			
Type	I		F	F	F			

Card 8d.2	1	2	3	4	5	6	7	8
Variable								
Type								

VARIABLE	DESCRIPTION
----------	-------------

FTYPE Failure criterion type (see [Remarks 5](#) and [6](#)):

EQ.0: No failure considered (default)

EQ.1: Puck Failure Criterion (PFC) (solid elements only)

EQ.2: Tsai-Wu Failure Criterion (TWFC) (solid elements only)

EQ.3: Generalized Tabulated Failure Criterion (GTFC)

FV1 In-plane and out-of-plane interaction term, n , used to compute d :

$$d = \begin{cases} \max(d_1, d_2) & \text{if } n = 0.0 \\ (d_1^n + d_2^n)^{1/n} & \text{otherwise} \end{cases}$$

where, $d_i = \varepsilon^{eq} / \varepsilon_{fail}$, $i = 1, 2$. $i = 1$ corresponds to the in-plane mode, while $i = 2$ corresponds to the out-of-plane mode. Here,

$$\varepsilon^{eq} = \begin{cases} \sqrt{\varepsilon_{11}^2 + \varepsilon_{22}^2 + 2\varepsilon_{12}^2} & \text{for in-plane} \\ \sqrt{\varepsilon_{33}^2 + 2\varepsilon_{13}^2 + 2\varepsilon_{23}^2} & \text{for out-of-plane} \end{cases}$$

An element is eroded if d reaches a value of 1.0 for solid elements. For shell elements, an element is eroded if d_1 reaches a value of 1.0 since only the in-plane mode of failure is considered [9]. n is not required for shell elements.

FV2 Table ID for the table containing in-plane $(\theta, \varepsilon_{fail})$ values with respect to the specified a -direction stress.

FV3 Table ID for the table containing out-of-plane $(\theta, \varepsilon_{fail})$ values with respect to the specified normal c -direction stress

Viscoelasticity Card. BETA values only need to be specified when V EVP = 1 or 2.

Card 9	1	2	3	4	5	6	7	8
Variable	BETA11	BETA22	BETA33	BETA44	BETA55	BETA66	BETA12	BETA23
Type	F	F	F	F	F	F	F	F
Default	0.001	0.001	0.001	0.001	0.001	0.001	↓	↓

VARIABLE	DESCRIPTION
----------	-------------

BETA11 Decay constant for the relaxation matrix of the viscoelastic law in 1-direction (default = 0.001). It must be greater than or equal to

VARIABLE	DESCRIPTION
	zero.
BETA22	Decay constant for the relaxation matrix of the viscoelastic law in 2-direction (default = 0.001). It must be greater than or equal to zero.
BETA33	Decay constant for the relaxation matrix of the viscoelastic law in 3-direction (default = 0.001). This field is <i>not</i> required for shell elements. It must be greater than or equal to zero.
BETA44	Decay constant for the relaxation matrix of the viscoelastic law in 12-shear (default = 0.001). It must be greater than or equal to zero.
BETA55	Decay constant for the relaxation matrix of the viscoelastic law in 23-shear (default = 0.001). This field is <i>not</i> required for shell elements. It must be greater than or equal to zero.
BETA66	Decay constant for the relaxation matrix of the viscoelastic law in 13-shear (default = 0.001). This field is <i>not</i> required for shell elements. It must be greater than or equal to zero.
BETA12	Decay constant for the relaxation matrix of the viscoelastic law 12-coupling (default = $(\text{BETA11} + \text{BETA22})/2$). It must be greater than or equal to zero.
BETA23	Decay constant for the relaxation matrix of the viscoelastic law 23-coupling (default = $(\text{BETA22} + \text{BETA33})/2$). This field is <i>not</i> required for shell elements. It must be greater than or equal to zero.

Viscoelasticity Card. BETA values only need to be specified when V EVP = 1 or 2.

Card 10	1	2	3	4	5	6	7	8
Variable	BETA13	CP	TQC	TEMP	PMACC			
Type	F	F	F	F	F			

VARIABLE	DESCRIPTION
BETA13	Decay constant for the relaxation matrix of the viscoelastic law 13-coupling (default = $(\text{BETA11} + \text{BETA33})/2$). This field is <i>not</i> required for shell elements. It must be greater than or equal to zero.
CP	Specific heat capacity (per unit mass)

VARIABLE	DESCRIPTION
TQC	Taylor-Quinney Coefficient
TEMP	This is the reference (or initial) temperature used to obtain the corresponding stress-strain curves.
PMACC	Plastic multiplier computational accuracy (see Remark 10): EQ.0: Use up to a maximum of 1000 increments (default) EQ.N: Specify a positive value, N, greater than 1 as the maximum number of increments. An error message is issued if a converged solution cannot be found.

Remarks:

1. **Flow Rule Coefficients.** Flow rule coefficients (FRC) are determined using the plastic Poisson's ratios [1, 2, 3]. Details on how to compute FRCs can be found in [8].
2. **Temperature-Strain Rate Test Result Tables.** A minimum of two sets of (strain rate-temperature) curves are needed. If the material is not temperature and rate sensitive, make the two sets of table data identical. If the material is rate and temperature sensitive, the curve corresponding to the smallest total strain rate for the given reference temperature (TEMP in Card 10) is assumed to be the quasi-static, room temperature (QS-RT) curve and influences the viscoelastic-plastic computations.

An example TABLE_3D (LT*i*) structure for 3 total strain rates and 3 temperatures for tension in the *a*-direction test is shown below. The total strain rates are converted within LS-DYNA into effective plastic strain rate (EPSR) for each of the input stress-strain curves. The EPSR value assigned for each stress-strain curve is used for yield stress interpolation.

Tension <i>a</i> -direction	DEFINE_TABLE_3D (Temperature)		DEFINE_TABLE (Total Strain Rate)	
	Table 1	Table 2: 10°C	Table 2	Curve 1 (10 ⁻³ /s)
				Curve 2 (1/s)
				Curve 3 (10/s)
	Table 1	Table 3: 20°C	Table 3	Curve 4 (10 ⁻³ /s)
				Curve 5 (1/s)
				Curve 6 (10/s)
	Table 1	Table 4: 50°C	Table 4	Curve 7 (10 ⁻³ /s)
				Curve 8 (1/s)
				Curve 9 (10/s)

Restrictions/assumptions about the input data are as follows:

- a) For normal (tension and compression) and shear curve data: Use positive stress and positive strain values in the curve data.
 - b) For off-axis curve data: Use positive stress and positive strain values in the curve data if the off-axis test is a tension test. Use negative stress and positive strain values in the curve data if the off-axis test is a compressive test. The same combination of tension-compression tests is assumed for all *MAT_213 cards used in a specific model. For instance, if the LT10-LT11-LT12 combination is tension-compression-compression for one set *MAT_213 data, then it is assumed that all other *MAT_213 data in the model use tension-compression-compression data.
 - c) All shear strain values are tensorial, not engineering (total strain rate input must be tensorial for shear component).
 - d) For an elastic component, meaning *a*-direction in a unidirectional composite, set the initial yield strain value (in YSC) greater than the failure strain (last strain value in the curve).
3. **YSC.** Curve of initial yield strain values (YSC) must list curves in ascending order as abscissa values with the corresponding yield strains given as the

ordinate values. An example YSC data is shown below for a case with two sets of (temperature, strain rate) data.

Load Curve	Yield Strain	Curves
LC1	ϵ_{y0}^{LC1}	Curve 1 (10°C, 10 ⁻³ /s)
LC2	ϵ_{y0}^{LC2}	Curve 2 (10°C, 10 ⁻³ /s)
LC3	ϵ_{y0}^{LC3}	Curve 3 (10°C, 10 ⁻³ /s)
LC4	ϵ_{y0}^{LC4}	Curve 4 (10°C, 10 ⁻³ /s)
LC5	ϵ_{y0}^{LC5}	Curve 5 (10°C, 10 ⁻³ /s)
LC6	ϵ_{y0}^{LC6}	Curve 6 (10°C, 10 ⁻³ /s)
LC7	ϵ_{y0}^{LC7}	Curve 7 (10°C, 10 ⁻³ /s)
LC8	ϵ_{y0}^{LC8}	Curve 8 (10°C, 10 ⁻³ /s)
LC9	ϵ_{y0}^{LC9}	Curve 9 (10°C, 10 ⁻³ /s)
LC10	ϵ_{y0}^{LC10}	Curve 10 (10°C, 10 ⁻³ /s)
LC11	ϵ_{y0}^{LC11}	Curve 11 (10°C, 10 ⁻³ /s)
LC12	ϵ_{y0}^{LC12}	Curve 12 (10°C, 10 ⁻³ /s)
LC13	ϵ_{y0}^{LC13}	Curve 1 (20°C, 10 ⁻³ /s)
LC14	ϵ_{y0}^{LC14}	Curve 2 (20°C, 10 ⁻³ /s)
LC15	ϵ_{y0}^{LC15}	Curve 3 (20°C, 10 ⁻³ /s)
LC16	ϵ_{y0}^{LC16}	Curve 4 (20°C, 10 ⁻³ /s)
LC17	ϵ_{y0}^{LC17}	Curve 5 (20°C, 10 ⁻³ /s)
LC18	ϵ_{y0}^{LC18}	Curve 6 (20°C, 10 ⁻³ /s)

Load Curve	Yield Strain	Curves
LC19	ϵ_{y0}^{LC19}	Curve 7 (20°C, 10 ⁻³ /s)
LC20	ϵ_{y0}^{LC20}	Curve 8 (20°C, 10 ⁻³ /s)
LC21	ϵ_{y0}^{LC21}	Curve 9 (20°C, 10 ⁻³ /s)
LC22	ϵ_{y0}^{LC22}	Curve 10 (20°C, 10 ⁻³ /s)
LC23	ϵ_{y0}^{LC23}	Curve 11 (20°C, 10 ⁻³ /s)
LC24	ϵ_{y0}^{LC24}	Curve 12 (20°C, 10 ⁻³ /s)

4. **Damage Curve.** Include in this curve only the active damage parameter ID and the corresponding curve ID. It should be noted that damage data are not rate and temperature dependent and are used with all relevant input stress-strain curves. The damage parameter ID definitions are shown in the following table. For shell elements, only in-plane damage is considered and only parameters 1, 2, 4, 5, 7, 13, 15, 16, 18, 21, 23, 24, 26, 37, 38, 40, 42, 45, 46, 48, 50, 61, 62, 64, 65 are active.

Damage Parameter ID	Damage Parameter	Damage Parameter ID	Damage Parameter	Damage Parameter ID	Damage Parameter
1	$d_{aaT}^{aaT}(\epsilon_{aaT})$	29	$d_{bbT}^{aaT}(\epsilon_{ccT})$	57	$d_{ccC}^{bbC}(\epsilon_{ccC})$
2	$d_{bbT}^{bbT}(\epsilon_{bbT})$	30	$d_{ccT}^{bbT}(\epsilon_{ccT})$	58	$d_{ccC}^{ab}(\epsilon_{ccC})$
3	$d_{ccT}^{ccT}(\epsilon_{ccT})$	31	$d_{ccT}^{aaC}(\epsilon_{ccT})$	59	$d_{ccC}^{bc}(\epsilon_{ccC})$
4	$d_{aaC}^{aaC}(\epsilon_{aaC})$	32	$d_{ccT}^{bbC}(\epsilon_{ccT})$	60	$d_{ccC}^{ac}(\epsilon_{ccC})$
5	$d_{bbC}^{bbC}(\epsilon_{bbC})$	33	$d_{ccT}^{ccC}(\epsilon_{ccT})$	61	$d_{ab}^{aaT}(\epsilon_{ab})$
6	$d_{ccC}^{ccC}(\epsilon_{ccC})$	34	$d_{ccT}^{ab}(\epsilon_{ccT})$	62	$d_{ab}^{bbT}(\epsilon_{ab})$
7	$d_{ab}^{ab}(\epsilon_{ab})$	35	$d_{ccT}^{bc}(\epsilon_{ccT})$	63	$d_{ab}^{ccT}(\epsilon_{ab})$
8	$d_{bc}^{bc}(\epsilon_{bc})$	36	$d_{ccT}^{ac}(\epsilon_{ccT})$	64	$d_{ab}^{aaC}(\epsilon_{ab})$

Damage Parameter ID	Damage Parameter	Damage Parameter ID	Damage Parameter	Damage Parameter ID	Damage Parameter
9	$d_{ac}^{ac}(\epsilon_{ac})$	37	$d_{aaT}^{aaT}(\epsilon_{aaT})$	65	$d_{ab}^{bbC}(\epsilon_{ab})$
10	$d_{oab}^{oab}(\epsilon_{oab})$	38	$d_{aaC}^{bbT}(\epsilon_{aaC})$	66	$d_{ab}^{ccc}(\epsilon_{ab})$
11	$d_{obc}^{obc}(\epsilon_{obc})$	39	$d_{aaC}^{ccT}(\epsilon_{aaC})$	67	$d_{ab}^{bc}(\epsilon_{ab})$
12	$d_{oac}^{oac}(\epsilon_{oac})$	40	$d_{aaC}^{bbC}(\epsilon_{aaC})$	68	$d_{ab}^{ac}(\epsilon_{ab})$
13	$d_{aaT}^{bbT}(\epsilon_{aaT})$	41	$d_{aaC}^{ccC}(\epsilon_{aaC})$	69	$d_{bc}^{aaT}(\epsilon_{bc})$
14	$d_{aaT}^{ccT}(\epsilon_{aaT})$	42	$d_{aaC}^{ab}(\epsilon_{aaC})$	70	$d_{bc}^{bbT}(\epsilon_{bc})$
15	$d_{aaT}^{aaC}(\epsilon_{aaT})$	43	$d_{aaC}^{bc}(\epsilon_{aaC})$	71	$d_{bc}^{ccT}(\epsilon_{bc})$
16	$d_{aaT}^{bbC}(\epsilon_{aaT})$	44	$d_{aaC}^{ac}(\epsilon_{aaC})$	72	$d_{bc}^{aac}(\epsilon_{bc})$
17	$d_{aaT}^{ccC}(\epsilon_{aaT})$	45	$d_{bbC}^{aaT}(\epsilon_{bbC})$	73	$d_{bc}^{bbc}(\epsilon_{bc})$
18	$d_{aaT}^{ab}(\epsilon_{aaT})$	46	$d_{bbC}^{bbT}(\epsilon_{bbC})$	74	$d_{bc}^{ccc}(\epsilon_{bc})$
19	$d_{aaT}^{bc}(\epsilon_{aaT})$	47	$d_{bbC}^{ccT}(\epsilon_{bbC})$	75	$d_{bc}^{ab}(\epsilon_{bc})$
20	$d_{aaT}^{ac}(\epsilon_{aaT})$	48	$d_{bbC}^{aaC}(\epsilon_{bbC})$	76	$d_{bc}^{ac}(\epsilon_{bc})$
21	$d_{bbT}^{aaT}(\epsilon_{bbT})$	49	$d_{bbC}^{ccC}(\epsilon_{bbC})$	77	$d_{ac}^{aaT}(\epsilon_{ac})$
22	$d_{bbT}^{ccT}(\epsilon_{bbT})$	50	$d_{bbC}^{ab}(\epsilon_{bbC})$	78	$d_{ac}^{bbT}(\epsilon_{ac})$
23	$d_{bbT}^{aaC}(\epsilon_{bbT})$	51	$d_{bbC}^{bc}(\epsilon_{bbC})$	79	$d_{ac}^{ccT}(\epsilon_{ac})$
24	$d_{bbT}^{bbC}(\epsilon_{bbT})$	52	$d_{bbC}^{ac}(\epsilon_{bbC})$	80	$d_{ac}^{aac}(\epsilon_{ac})$
25	$d_{bbT}^{ccC}(\epsilon_{bbT})$	53	$d_{ccC}^{aaT}(\epsilon_{ccC})$	81	$d_{ac}^{bbC}(\epsilon_{ac})$
26	$d_{bbT}^{ab}(\epsilon_{bbT})$	54	$d_{ccC}^{bbT}(\epsilon_{ccC})$	82	$d_{ac}^{ccc}(\epsilon_{ac})$
27	$d_{bbT}^{bc}(\epsilon_{bbT})$	55	$d_{ccC}^{ccT}(\epsilon_{ccC})$	83	$d_{ac}^{ab}(\epsilon_{ac})$

Damage Parameter ID	Damage Parameter	Damage Parameter ID	Damage Parameter	Damage Parameter ID	Damage Parameter
28	$d_{bb_T}^{ac}(\epsilon_{bb_T})$	56	$d_{cc_C}^{aa}(\epsilon_{cc_C})$	84	$d_{ac}^{bc}(\epsilon_{ac})$

For example, to include damage information only for $d_{bb_C}^{bc}(\epsilon_{bb_C})$ (uncoupled *b*-direction compression) and $d_{ab}^{ab}(\epsilon_{ab})$ (uncoupled shear *a-b*), the following input can be used.

```
*DEFINE_CURVE
$$ Curve of Damage Index and Corresponding Damage Curves
$$ a-Damage Index      o-Damage Curve (damage vs. total strain)
$#   lcid      sidr      sfa      sfo      offa      offo      dattyp
     101        0      0.000    0.000    0.000    0.000        0
$#           a           o
           5           25
           7           26
```

A typical damage curve has the total strain in the loading direction as abscissa values with the corresponding damage value given as the ordinate values as shown below. The final strain value in the curve must correspond to the final strain in the corresponding QS-RT input stress-strain curve.

Total Strain	Damage
0.0	0.0
0.01	0.0
0.02	0.0
0.03	0.05
0.04	0.08
0.05	0.12
0.06	0.17
0.07	0.23
0.08	0.3

- Failure Criterion.** Use Cards 8*n*.1 and 8*n*.2 for the failure criterion to be included in the failure model. The failure criterion and associated values are given as (see [5] for details)

- a) *Puck Failure Criterion (PFC)*. For this criterion, $FTYPE = 1$ and $FV0, \dots, FV14$ are the magnitudes of fracture energy, damage, magnification factor, slope parameters, and material parameters for the fiber.
- b) *Tsai-Wu Failure Criterion (TWFC)*. For this criterion, $FTYPE = 2$ and $FV1, \dots, FV12$ are the magnitudes of the failure stresses $\hat{\sigma}_{aa}^T, \hat{\sigma}_{aa}^C, \hat{\sigma}_{bb}^T, \hat{\sigma}_{bb}^C, \hat{\sigma}_{cc}^T, \hat{\sigma}_{cc}^C, \hat{\sigma}_{ab}, \hat{\sigma}_{bc}, \hat{\sigma}_{ac}, \hat{\sigma}_{ab}^{45}, \hat{\sigma}_{bc}^{45}$, and $\hat{\sigma}_{ac}^{45}$.
- c) *Generalized Tabulated Failure Criterion (GTFC)*. For solid elements with $FTYPE = 3$, $FV1$ is n , the in-plane and out-of-plane interaction term. $FV2$ and $FV3$ are the Table IDs of the two tables for the in-plane and the out-of-plane $(\theta, \varepsilon_{fail})$ values that define the in-plane and out-of-plane failure surfaces, respectively. For the in-plane failure surface, the table contains the a -direction stress (S11) value-curve ID pairs. For the out-of-plane failure surface, the table contains the normal c -direction stress (S33) value-curve ID pairs. For shell elements, only $FV2$ is used with the preceding definition and the element fails when the damage is 1. There is no data in card 8d.2.

A partial example is shown below for solid elements.

```

$# Card 8d.1
$#   FTYPE           FV0           FV1           FV2           FV3
           3                2.0           9013           9014
$# Card 8d.2
$#
. . .

$$ theta - equivalent failure strain (efs)
*DEFINE_TABLE
$#   tbid           sfa           offa
           9013                0           0.000
$#           value           curveid
           0.0                90131
           366000.0           90132
*DEFINE_CURVE
$$ theta - equivalent failure strain for S11 = 0.0
$#   lcid           sidr           sfa           sfo           offa
offo   dattyp
           90131                0           0.000           0.000           0.000
0.000           0
$#           a1                o1
           -180.000           0.02
           180.000           0.02
*DEFINE_CURVE
$$ theta - equivalent failure strain for S11 = 366000.0

```

\$#	lcid	sidr	sfa	sfo	offa
offo	dattyp				
	90132	0	0.000	0.000	0.000
0.000		0			
\$#		a1		o1	
		-180.000		0.02	
		180.000		0.02	

Repeat the *DEFINE_TABLE for Table ID 9014 with a set of normal c -direction stress (S33) values-curve ID pairs, followed by *DEFINE_CURVE for all the theta-equivalent failure strain curves for different normal c -direction stress (S33) data..

6. **Element Erosion.** Element is eroded if failure occurs at any one Gauss point. Note that *DEFINE_ELEMENT_EROSION_SHELL is required for shell element erosion; the number of integration points needed to fail to erode the element is defined there.
7. **Adjusting Stress-Strain Curves.** The user-defined stress-strain curves are adjusted when using TCSYM = 1, 2, and 3 as follows. If $E_a^{T_0}$ and $E_a^{C_0}$ represent the original a -direction (1-direction) elastic tensile and compressive moduli respectively, then the modified elastic moduli are computed as

$$\text{a) } TCSYM = 1. E_a^T = E_a^C = 0.5(E_a^{T_0} + E_a^{C_0})$$

$$\text{b) } TCSYM = 2. E_a^T = E_a^{T_0} \text{ and } E_a^C = E_a^{C_0}$$

$$\text{c) } TCSYM = 3. E_a^T = E_a^{C_0} \text{ and } E_a^C = E_a^{T_0}$$

Let $R_a^T = E_a^T / E_a^{T_0}$ and $R_a^C = E_a^C / E_a^{C_0}$. The adjusted tensile strain is then computed as the original tensile strain divided by R_a^T , the adjusted compressive strain is computed as the original compressive strain divided by R_a^C , the adjusted tensile yield strain is computed as the original tensile yield strain divided by R_a^T , and the adjusted compressive yield strain is computed as the original compressive yield strain divided by R_a^C . The same process is then applied to the other two normal directions.

8. **Curve Discretization.** For this material, only LCINT on *CONTROL_SOLUTION (not with *DEFINE_CURVE) can be used to specify the number of discretized points for the input curves. The default value is 100.
9. **Poisson's Ratios.** If necessary, the input Poisson's ratios are adjusted internally in LS-DYNA to satisfy the criteria described in [6].
10. **Plastic Multiplier.** The plastic multiplier computations involve finding the root of the yield function. The root is computed numerically, not analytically. The

first step is to find the interval bounding the root. The value of N set in field PMACC on Card 10 controls the discretization of the interval to find the bound. The larger the value of N, the more accurate the bound. However, the computational time is likely to increase with larger values of N.

11. **Stochastic Variation.** A stochastic variation can be added using keyword *DEFINE_STOCHASTIC_VARIATION_PROPERTIES. There are six quantities (see table below) which can be varied, so Card 2 in *DEFINE_STOCHASTIC_VARIATION_PROPERTIES must be defined six times and assumes that the quantities being varied are in the order specified.

Material Properties to be Varied in Predefined Order
E_a
G_{ab}
G_{bc}
G_{ca}
In-plane failure radius
Out-of-plane failure radius

12. **Damage Formulation.** By default, the damage calculations are carried out using total stress in effective space as the internal state variable for tracking growth of damage parameters d_{cd}^{ab} . An alternate formulation is available where the damage parameters are taken as functions of directional plastic strains to track damage growth. Details of both the formulations are available in [10].

External Files Generated by MAT_213:

Two sets of external files are generated which contain information connected with the input stress-strain curves. The first set of files have a naming convention of "MAT_213__input_curve__stress-strain__curve_id_i.plt" Here, i is the i^{th} load curve input into *MAT_213. Each of these files contain LCINT (see Remark 8) stress-strain curve data points. An example of the set of files generated is shown below.

File Name	Load Curve
MAT_213__input_curve__stress-strain__curve_id_1.plt	LC1

File Name	Load Curve
MAT_213__input_curve__stress-strain__curve_id_2.plt	LC2
MAT_213__input_curve__stress-strain__curve_id_3.plt	LC3
MAT_213__input_curve__stress-strain__curve_id_4.plt	LC4
MAT_213__input_curve__stress-strain__curve_id_5.plt	LC5
MAT_213__input_curve__stress-strain__curve_id_6.plt	LC6
MAT_213__input_curve__stress-strain__curve_id_7.plt	LC7
MAT_213__input_curve__stress-strain__curve_id_8.plt	LC8
MAT_213__input_curve__stress-strain__curve_id_9.plt	LC9
MAT_213__input_curve__stress-strain__curve_id_10.plt	LC10
MAT_213__input_curve__stress-strain__curve_id_11.plt	LC11
MAT_213__input_curve__stress-strain__curve_id_12.plt	LC12
MAT_213__input_curve__stress-strain__curve_id_13.plt	LC13
MAT_213__input_curve__stress-strain__curve_id_14.plt	LC14
MAT_213__input_curve__stress-strain__curve_id_15.plt	LC15
MAT_213__input_curve__stress-strain__curve_id_16.plt	LC16
MAT_213__input_curve__stress-strain__curve_id_17.plt	LC17
MAT_213__input_curve__stress-strain__curve_id_18.plt	LC18
MAT_213__input_curve__stress-strain__curve_id_19.plt	LC19
MAT_213__input_curve__stress-strain__curve_id_20.plt	LC20
MAT_213__input_curve__stress-strain__curve_id_21.plt	LC21
MAT_213__input_curve__stress-strain__curve_id_22.plt	LC22
MAT_213__input_curve__stress-strain__curve_id_23.plt	LC23
MAT_213__input_curve__stress-strain__curve_id_24.plt	LC24

MAT_213**MAT_COMPOSITE_TABULATED_PLASTICITY_DAMAGE**

The second set of files have a naming convention of “MAT_213__modified_curve__stress-pl_strain__curve_id_*i*.plt”. As above, *i* is the *i*th load curve input into *MAT_213. Each of these files contains LCINT stress-effective plastic strain curve data points. We urge you to use these plot files to check if the stress-effective plastic strain curves for each of the 12 components intersect or not when rate and temperature sensitive data are input. Intersecting curves or intersecting extrapolated curves for a component are likely to lead to inconsistent results. An example of the set of files generated is shown below.

File name	Load Curve
MAT_213__modified_curve__stress-pl_strain__curve_id_1.plt	LC1
MAT_213__modified_curve__stress-pl_strain__curve_id_2.plt	LC2
MAT_213__modified_curve__stress-pl_strain__curve_id_3.plt	LC3
MAT_213__modified_curve__stress-pl_strain__curve_id_4.plt	LC4
MAT_213__modified_curve__stress-pl_strain__curve_id_5.plt	LC5
MAT_213__modified_curve__stress-pl_strain__curve_id_6.plt	LC6
MAT_213__modified_curve__stress-pl_strain__curve_id_7.plt	LC7
MAT_213__modified_curve__stress-pl_strain__curve_id_8.plt	LC8
MAT_213__modified_curve__stress-pl_strain__curve_id_9.plt	LC9
MAT_213__modified_curve__stress-pl_strain__curve_id_10.plt	LC10
MAT_213__modified_curve__stress-pl_strain__curve_id_11.plt	LC11
MAT_213__modified_curve__stress-pl_strain__curve_id_12.plt	LC12
MAT_213__modified_curve__stress-pl_strain__curve_id_13.plt	LC13
MAT_213__modified_curve__stress-pl_strain__curve_id_14.plt	LC14
MAT_213__modified_curve__stress-pl_strain__curve_id_15.plt	LC15
MAT_213__modified_curve__stress-pl_strain__curve_id_16.plt	LC16
MAT_213__modified_curve__stress-pl_strain__curve_id_17.plt	LC17
MAT_213__modified_curve__stress-pl_strain__curve_id_18.plt	LC18
MAT_213__modified_curve__stress-pl_strain__curve_id_19.plt	LC19

File name	Load Curve
MAT_213__modified_curve__stress-pl_strain__curve_id_20.plt	LC20
MAT_213__modified_curve__stress-pl_strain__curve_id_21.plt	LC21
MAT_213__modified_curve__stress-pl_strain__curve_id_22.plt	LC22
MAT_213__modified_curve__stress-pl_strain__curve_id_23.plt	LC23
MAT_213__modified_curve__stress-pl_strain__curve_id_24.plt	LC24

Each of the aforementioned “MAT_213__modified_curve__stress-pl_strain__curve_id_*i*.plt” files have similar headings

```
Curveplot
MAT213 mod crv i (EPSR =      xxxx.xxx)
effective plastic strain
stress
stress curve
stress #pts=      "LCINT"
```

List of History Variables for Solid Elements (LS-PrePost):

History Variable #	Symbols	Description
15	c_1^d	Damage in <i>a</i> -direction, tension
16	c_2^d	Damage in <i>b</i> -direction, tension
17	c_3^d	Damage in <i>c</i> -direction, tension
18	c_4^d	Damage in <i>a</i> -direction, compression
19	c_5^d	Damage in <i>b</i> -direction, compression
20	c_6^d	Damage in <i>c</i> -direction, compression
21	c_7^d	Damage in <i>a-b</i> plane, shear
22	c_8^d	Damage in <i>b-c</i> plane, shear
23	c_9^d	Damage in <i>a-c</i> plane, shear

History Variable #	Symbols	Description
24	d	Failure term (FTYPE = 3)
25	d_1	Equivalent strain/ Equivalent failure strain for in-plane mode (FTYPE = 3)
26	d_2	Equivalent strain/ Equivalent failure strain for out-of-plane mode (FTYPE = 3)
27	r_{IP}^f	Equivalent failure strain for in-plane mode (FTYPE = 3)
28	r_{IP}	Equivalent strain for in-plane mode (FTYPE = 3)
29	θ_{IP}	Failure angle for in-plane mode (FTYPE = 3)
30	r_{OOP}^f	Equivalent failure strain for out-of-plane mode (FTYPE = 3)
31	r_{OOP}	Equivalent strain for out-of-plane mode (FTYPE = 3)
32	θ_{OOP}	Failure angle for out-of-plane mode (FTYPE = 3)
24	ε_{aa}^0	Strain at failure onset in a -direction (FTYPE = 1)
25	ε_{aa}^f	Strain for erosion in a -direction (FTYPE = 1)
26	ε_{bb}^0	Strain at failure onset in b -direction (FTYPE = 1)
27	ε_{bb}^f	Strain for erosion in b -direction (FTYPE = 1)
28	ε_{cc}^0	Strain at failure onset in c -direction (FTYPE = 1)
29	ε_{cc}^f	Strain for erosion in c -direction (FTYPE = 1)
30	ε_{ab}^0	Tensorial shear strain at failure onset in a - b plane (FTYPE = 1)
31	ε_{ab}^f	Tensorial shear strain for erosion in a - b plane (FTYPE = 1)
32	ε_{bc}^0	Tensorial shear strain at failure onset in b - c plane (FTYPE = 1)
33	ε_{bc}^f	Tensorial shear strain for erosion in b - c plane (FTYPE = 1)

History Variable #	Symbols	Description
34	ε_{ac}^0	Tensorial shear strain at failure onset in a - c plane (FTYPE = 1)
35	ε_{ac}^f	Tensorial shear strain for erosion in a - c plane (FTYPE = 1)
36	FF	Flag for fiber-fracture
37	IFF	Flag for inter-fiber-fracture
38	T	Temperature
39	$\dot{\varepsilon}_{aaT}$	Tensile strain rate in a -direction
40	$\dot{\varepsilon}_{bbT}$	Tensile strain rate in b -direction
41	$\dot{\varepsilon}_{ccT}$	Tensile strain rate in c -direction
42	$\dot{\varepsilon}_{aaC}$	Compressive strain rate in a -direction
43	$\dot{\varepsilon}_{bbC}$	Compressive strain rate in b -direction
44	$\dot{\varepsilon}_{ccC}$	Compressive strain rate in c -direction
45	$\dot{\varepsilon}_{ab}$	Tensorial shear strain rate in a - b plane
46	$\dot{\varepsilon}_{bc}$	Tensorial shear strain rate in b - c plane
47	$\dot{\varepsilon}_{ac}$	Tensorial shear strain rate in a - c plane
48	$\sigma_{aaT}^{\text{eff}}$ or $\varepsilon_{aaT}^{\text{cp}}$	DFLAG.EQ.0: Effective tensile stress in the a -direction DFLAG.EQ.1: Corrected tensile plastic strain the a -direction
49	$\sigma_{bbT}^{\text{eff}}$ or $\varepsilon_{bbT}^{\text{cp}}$	DFLAG.EQ.0: Effective tensile stress in the b -direction DFLAG.EQ.1: Corrected tensile plastic strain the b -direction
50	$\sigma_{ccT}^{\text{eff}}$ or $\varepsilon_{ccT}^{\text{cp}}$	DFLAG.EQ.0: Effective tensile stress in the c -direction DFLAG.EQ.1: Corrected tensile plastic strain the c -direction

History Variable #	Symbols	Description
51	$\sigma_{aa_C}^{eff}$ or $\varepsilon_{aa_C}^{cp}$	DFLAG.EQ.0: Effective compressive stress in the <i>a</i> -direction DFLAG.EQ.1: Corrected compressive plastic strain the <i>a</i> -direction
52	$\sigma_{bb_C}^{eff}$ or $\varepsilon_{bb_C}^{cp}$	DFLAG.EQ.0: Effective compressive stress in the <i>b</i> -direction DFLAG.EQ.1: Corrected compressive plastic strain the <i>b</i> -direction
53	$\sigma_{cc_C}^{eff}$ or $\varepsilon_{cc_C}^{cp}$	DFLAG.EQ.0: Effective compressive stress in the <i>c</i> -direction DFLAG.EQ.1: Corrected compressive plastic strain the <i>c</i> -direction
54	σ_{ab}^{eff} or ε_{ab}^{cp}	DFLAG.EQ.0: Effective shear stress in the <i>a-b</i> plane DFLAG.EQ.1: Corrected plastic tensorial strain the <i>a-b</i> plane
55	σ_{bc}^{eff} or ε_{bc}^{cp}	DFLAG.EQ.0: Effective shear stress in the <i>b-c</i> plane DFLAG.EQ.1: Corrected plastic tensorial strain the <i>b-c</i> plane
56	σ_{ac}^{eff} or ε_{ac}^{cp}	DFLAG.EQ.0: Effective shear stress in the <i>a-c</i> plane DFLAG.EQ.1: Corrected plastic tensorial strain the <i>a-c</i> plane
57	λ	Effective plastic strain
58	ε_{aa}	Strain in <i>a</i> -direction
59	ε_{bb}	Strain in <i>b</i> -direction
60	ε_{cc}	Strain in <i>c</i> -direction
61	ε_{ab}	Tensorial shear strain in <i>a-b</i> plane
62	ε_{bc}	Tensorial shear strain in <i>b-c</i> plane
63	ε_{ac}	Tensorial shear strain in <i>a-c</i> plane

History Variable #	Symbols	Description
64	σ_{aaT}^y	Yield stress in tension a -direction
65	σ_{bbT}^y	Yield stress in tension b -direction
66	σ_{ccT}^y	Yield stress in tension c -direction
67	σ_{aaC}^y	Yield stress in compression a -direction
68	σ_{bbC}^y	Yield stress in compression b -direction
69	σ_{ccC}^y	Yield stress in compression c -direction
70	σ_{ab}^y	Yield stress in shear a - b plane
71	σ_{bc}^y	Yield stress in shear b - c plane
72	σ_{ac}^y	Yield stress in shear a - c plane
73	T	Current cycle
74	σ_{aa}^e	Equilibrium stress in a -direction
75	σ_{bb}^e	Equilibrium stress in b -direction
76	σ_{cc}^e	Equilibrium stress in c -direction
77	σ_{ab}^e	Equilibrium shear stress in a - b plane
78	σ_{bc}^e	Equilibrium shear stress in b - c plane
79	σ_{ac}^e	Equilibrium shear stress in a - c plane
80	σ_{aa}^v	Viscous stress in a -direction
81	σ_{bb}^v	Viscous stress in b -direction
82	σ_{cc}^v	Viscous stress in c -direction
83	σ_{ab}^v	Viscous shear stress in a - b plane
90	σ_{bc}^v	Viscous shear stress in b - c plane

History Variable #	Symbols	Description
91	σ_{ac}^v	Viscous shear stress in a-c plane

List of History Variables for Shell Elements (LS-PrePost):

History Variable Shells #	Symbols	Description
13	d_{\max}	Maximum damage parameter
14	c_1^d	Damage in a -direction, tension
15	c_2^d	Damage in b -direction, tension
16	c_4^d	Damage in a -direction, compression
17	c_5^d	Damage in b -direction, compression
18	c_7^d	Damage in a - b plane, shear
19	d	Failure term (FTYPE = 3)
20	r_{IP}	Equivalent strain for in-plane mode
21	θ_{IP}	Failure angle for in-plane mode
22	F	Flag for failure of integration point. "1" if $d \geq 1$
23	T	Temperature
24	$\dot{\lambda}$	Effective plastic strain
25	$\dot{\epsilon}_{aa_T}$	Tensile strain rate in the a -direction
26	$\dot{\epsilon}_{bb_T}$	Tensile strain rate in the b -direction
27	$\dot{\epsilon}_{aa_C}$	Compressive strain rate in the a -direction
28	$\dot{\epsilon}_{bb_C}$	Compressive strain rate in the b -direction
29	$\dot{\epsilon}_{ab}$	Tensorial shear strain rate in the a - b plane

History Variable Shells #	Symbols	Description
30	ε_{aaT}^p	Tensile plastic strain in the a -direction
31	ε_{bbT}^p	Tensile plastic strain in the b -direction
32	ε_{ccT}^p	Tensile plastic strain in the c -direction
33	ε_{aaC}^p	Compressive plastic strain in the a -direction
34	ε_{bbC}^p	Compressive plastic strain in the b -direction
35	ε_{ccC}^p	Compressive plastic strain in the c -direction
36	ε_{ab}^p	Plastic tensorial shear strain in the a - b plane
37	λ	Effective plastic strain
38	ε_{aa}	Strain in a -direction
39	ε_{bb}	Strain in b -direction
40	ε_{cc}	Strain in c -direction
41	ε_{ab}	Tensorial shear strain in a - b plane
42	ε_{bc}	Tensorial shear strain in b - c plane
43	ε_{ac}	Tensorial shear strain in a - c plane
44	σ_{aa}	Stress in a -direction
45	σ_{bb}	Stress in b -direction
46	σ_{ab}	Shear stress in a - b plane
47	σ_{bc}	Shear stress in b - c plane
48	σ_{ac}	Shear stress in a - c plane
49	σ_{aa}^e	Equilibrium stress in a -direction
50	σ_{bb}^e	Equilibrium stress in b -direction
51	σ_{ab}^e	Equilibrium shear stress in a - b plane

History Variable Shells #	Symbols	Description
52	σ_{aa}^v	Viscous stress in a -direction
53	σ_{bb}^v	Viscous stress in b -direction
54	σ_{ab}^v	Viscous shear stress in a - b plane
55	ε_{aaT}^{cp}	Corrected plastic strain in a -direction, tension
56	ε_{bbT}^{cp}	Corrected plastic strain in b -direction, tension
57	ε_{aaC}^{cp}	Corrected plastic strain in a -direction, compression
58	ε_{bbC}^{cp}	Corrected plastic strain in b -direction, compression
59	σ_{aaT}^y	Yield stress in tension a -direction
60	σ_{bbT}^y	Yield stress in tension b -direction
61	σ_{aaC}^y	Yield stress in compression a -direction
62	σ_{bbC}^y	Yield stress in compression b -direction
63	σ_{ab}^y	Yield stress in shear a - b plane
64	$\sigma_{ab}^{y,45}$	Yield stress in 45° off-axis a - b plane
65	E_p	Dissipated plastic energy

References:

- [1] R. Goldberg, K. Carney, P. DuBois, C. Hoffarth, J. Harrington, S.D. Rajan and G. Blankenhorn, "Development of an Orthotropic Elasto-Plastic Generalized Composite Material Model Suitable for Impact Problems," ASCE J of Aerospace Engineering, [https://doi.org/10.1061/\(ASCE\)AS.1943-5525.0000580](https://doi.org/10.1061/(ASCE)AS.1943-5525.0000580), Dec 2015.
- [2] C. Hoffarth, S.D. Rajan, R. Goldberg, K. Carney, P. DuBois, and G. Blankenhorn, "Implementation and Validation of a Three-Dimensional Plasticity-Based Deformation Model for Orthotropic Composites," Composites A, <https://doi.org/10.1016/j.compositesa.2016.10.024>, December 2016.
- [3] C. Hoffarth, B. Khaled, L. Shyamsunder, S.D. Rajan, R. Goldberg, K. Carney, P. DuBois, and G. Blankenhorn, "Verification and Validation of a Three-Dimensional Orthotropic Plasticity Constitutive Model Using a Unidirectional Composite," Fibers, 5(1), 12; <https://doi.org/10.3390/fib5010012>, March 2017.

- [4] B. Khaled, L. Shyamsunder, C. Hoffarth, S.D. Rajan, R.K. Goldberg, K.S. Carney, P. DuBois, and G. Blankenhorn, "Experimental Characterization of Composites to Support an Orthotropic Plasticity Material Model," J of Composite Materials, <https://doi.org/10.1177/0021998317733319>, August 2017.
- [5] L. Shyamsunder, B. Khaled, C. Hoffarth and S.D. Rajan, "MAT213 Failure Implementation," Technical Report, School of Sustainable Engineering & the Built Environment, Arizona State University, Tempe, AZ, August 2017.
- [6] L. Shyamsunder, B. Khaled, S.D. Rajan, K.S. Carney, P. DuBois, and G. Blankenhorn, "Enhancement of deformation sub-model in an Orthotropic Material Model", 16th international LS-DYNA Users Conference, Detroit, June, 2020.
- [7] L. Shyamsunder, B. Khaled, S.D. Rajan, R.K. Goldberg, K.S. Carney, P. DuBois, and G. Blankenhorn, "Implementing deformation, damage, and failure in an orthotropic plastic material model", J of Composite Materials, DOI: 10.1177/0021998319865006, 2019.
- [8] S.D. Rajan, C. Hoffarth, B. Khaled, and L. Shyamsunder, "MAT_213 User Guide", April, 2020.
- [9] T. Achstetter, "Development of a composite material shell-element model for impact applications", PhD Dissertation, George Mason University, 2019.
- [10] B. Khaled, "Experimental Characterization and Finite Element Modeling of Composites to Support a Generalized Orthotropic Elasto-Plastic Damage Material Model for Impact Analysis", PhD Dissertation, Arizona State University, 2019.

***MAT_DRY_FABRIC**

This is Material Type 214. This material model can be used to model high strength woven fabrics, such as Kevlar® 49, with transverse orthotropic behavior for use in structural systems where high energy absorption is required (Bansal et al., Naik et al., Stahlecker et al.). The major applications of the model are for the materials used in propulsion engine containment system, body armor and personal protections.

Woven dry fabrics are described in terms of two principal material directions, longitudinal warp and transverse fill yarns. The primary failure mode in these materials is the breaking of either transverse or longitudinal yarn. An equivalent continuum formulation is used and an element is designated as having failed when it reaches some critical value for strain in either directions. A linearized approximation to a typical stress-strain curve is shown in [Figure M214-1](#) and to a typical engineering shear stress-strain curve is shown in the figure corresponding to the GAB_i field in the variable list. Note that the principal directions are labeled a for the warp and b for the fill, and the direction c is orthogonal to a and b .

The material model is available for membrane elements and it is recommended to use a double precision version of LS-DYNA.

Card Summary:

Card 1. This card is required.

MID	RO	EA	EB	GAB1	GAB2	GAB3	
-----	----	----	----	------	------	------	--

Card 2. This card is required.

GBC	GCA	GAMAB1	GAMAB2				
-----	-----	--------	--------	--	--	--	--

Card 3. This card is required.

AOPT					A1	A2	A3
------	--	--	--	--	----	----	----

Card 4. This card is required.

V1	V2	V3	D1	D2	D3	BETA	
----	----	----	----	----	----	------	--

Card 5. This card is required.

EACRF	EBCRF	EACRP	EBCRP				
-------	-------	-------	-------	--	--	--	--

Card 6. This card is required.

EASF	EBSF	EUNLF	ECOMF	EAMAX	EBMAX	SIGPOST	
------	------	-------	-------	-------	-------	---------	--

Card 7. This card is required.

CCE	PCE	CSE	PSE	DFAC	EMAX	EAFail	EBFail
-----	-----	-----	-----	------	------	--------	--------

Data Card Definitions:

Card 1	1	2	3	4	5	6	7	8
Variable	MID	RO	EA	EB	GAB1	GAB2	GAB3	
Type	A	F	F	F	F	F	F	

Card 2	1	2	3	4	5	6	7	8
Variable	GBC	GCA	GAMAB1	GAMAB2				
Type	F	F	F	F				

VARIABLE

DESCRIPTION

- MID Material identification. A unique number or label must be specified (see *PART).
- RO Continuum equivalent mass density
- EA Modulus of elasticity in the longitudinal (warp) direction, which corresponds to the slope of segment AB in [Figure M214-1](#)
- EB Modulus of elasticity in the transverse (fill) direction, which corresponds to the slope of segment of AB in [Figure M214-1](#)

GAB_i /
GAMAB_i

Shear stress-strain behavior is modeled as piecewise linear in three segments. See the figure to the right. The shear moduli GAB_i correspond to the slope of the *i*th segment. The start and end points for the segments are specified in the GAMAB[1-2] fields.

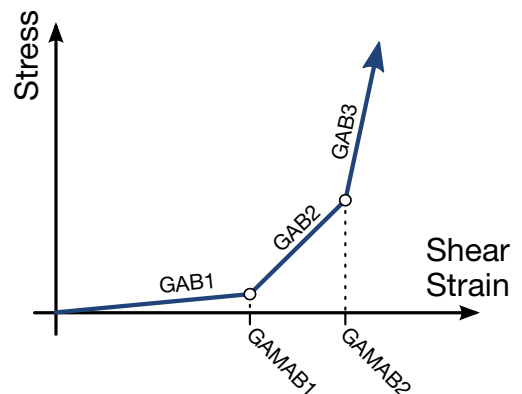

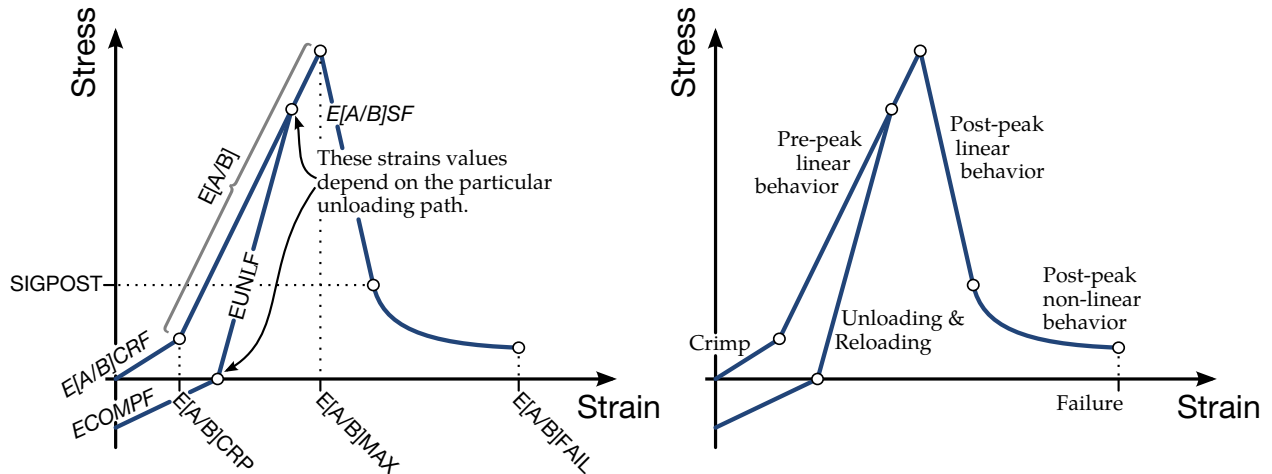

Figure M214-1. Stress – Strain curve for *MAT_DRY_FABRIC. This curve models the force-response in the longitudinal and transverse directions.

VARIABLE	DESCRIPTION
----------	-------------

GBC	G_{bc} , shear modulus in bc direction
GCA	G_{ca} , shear modulus in ca direction

Card 3	1	2	3	4	5	6	7	8
Variable	AOPT		XP	YP	ZP	A1	A2	A3
Type	F		F	F	F	F	F	F

VARIABLE	DESCRIPTION
----------	-------------

AOPT	Material axes option. See *MAT_OPTIONTROPIC_ELASTIC for a more complete description: EQ.0.0: locally orthotropic with material axes determined by element nodes 1, 2, and 4, as with *DEFINE_COORDINATE_NODES, and then rotated about the element normal by an angle BETA EQ.2.0: globally orthotropic with material axes determined by vectors defined below, as with *DEFINE_COORDINATE_VECTOR
------	--

VARIABLE

DESCRIPTION

EQ.3.0: locally orthotropic material axes determined by rotating the material axes about the element normal by an angle, BETA, from a line in the plane of the element defined by the cross product of the vector **v** with the element normal

LT.0.0: the absolute value of AOPT is a coordinate system ID number (CID on *DEFINE_COORDINATE_NODES, *DEFINE_COORDINATE_SYSTEM or *DEFINE_COORDINATE_VECTOR). Available in R3 version of 971 and later.

A1, A2, A3 Components of vector **a** for AOPT = 2

Card 4	1	2	3	4	5	6	7	8
Variable	V1	V2	V3	D1	D2	D3	BETA	
Type	F	F	F	F	F	F	F	

VARIABLE

DESCRIPTION

V1, V2, V3 Components of vector **v** for AOPT = 3

D1, D2, D3 Components of vector **d** for AOPT = 2

BETA Material angle in degrees for AOPT = 0 and 3. BETA may be overridden on the element card; see *ELEMENT_SHELL_BETA.

Card 5	1	2	3	4	5	6	7	8
Variable	EACRF	EBCRF	EACRP	EBCRP				
Type	F	F	F	F				
Remarks	2	2						

VARIABLE	DESCRIPTION
-----------------	--------------------

EACRF Factor for crimp region modulus of elasticity in longitudinal direction (see [Figure M214-1](#)):

$$E_{a,crimp} = E_{a,crimpfac}E, \quad E_{a,crimpfac} = EACRF$$

EBCRF Factor for crimp region modulus of elasticity in transverse direction (see [Figure M214-1](#)):

$$E_{b,crimp} = E_{b,crimpfac}E, \quad E_{b,crimpfac} = EBCRF$$

EACRP Crimp strain in longitudinal direction (see [Figure M214-1](#)):

$$\epsilon_{a,crimp}$$

EBCRP Crimp strain in transverse direction (see [Figure M214-1](#)):

$$\epsilon_{b,crimp}$$

Card 6	1	2	3	4	5	6	7	8
Variable	EASF	EBSF	EUNLF	ECOMF	EAMAX	EBMAX	SIGPOST	
Type	F	F	F	F	F	F	F	
Remarks	2	2	2	2				

VARIABLE	DESCRIPTION
-----------------	--------------------

EASF Factor for post-peak region modulus of elasticity in longitudinal direction (see [Figure M214-1](#)):

$$E_{a,soft} = E_{a,softfac}E, \quad E_{a,softfac} = EASF$$

EBSF Factor for post-peak region modulus of elasticity in transverse direction (see [Figure M214-1](#)):

$$E_{b,soft} = E_{b,softfac}E, \quad E_{b,softfac} = EBSF$$

EUNLF Factor for unloading modulus of elasticity (see [Figure M214-1](#)):

$$E_{unload} = E_{unloadfac}E, \quad E_{unloadfac} = EUNLF$$

VARIABLE	DESCRIPTION
ECOMPF	Factor for compression zone modulus of elasticity (see Figure M214-1): $E_{\text{comp}} = E_{\text{compfac}}E, \quad E_{\text{compfac}} = \text{ECOMPF}$
EAMAX	Strain at peak stress in longitudinal direction (see Figure M214-1): $\epsilon_{a,\text{max}}$
EBMAX	Strain at peak stress in transverse direction (see Figure M214-1): $\epsilon_{b,\text{max}}$
SIGPOST	Stress value in post-peak region at which nonlinear behavior begins (see Figure M214-1): σ_{post}

Card 7	1	2	3	4	5	6	7	8
Variable	CCE	PCE	CSE	PSE	DFAC	EMAX	EAFAIL	EBFAIL
Type	F	F	F	F	F	F	F	F
Remarks	1	1	1	1	2	3	2, 3	2, 3

VARIABLE	DESCRIPTION
CCE	Strain rate parameter <i>C</i> , Cowper-Symonds factor for modulus. If zero, rate effects are not considered.
PCE	Strain rate parameter <i>P</i> , Cowper-Symonds factor for modulus. If zero, rate effects are not considered.
CSE	Strain rate parameter <i>C</i> , Cowper-Symonds factor for stress to peak / failure. If zero, rate effects are not considered.
PSE	Strain rate parameter <i>P</i> , Cowper-Symonds factor for stress to peak / failure. If zero, rate effects are not considered.
DFAC	Damage factor: d_{fac}

VARIABLE	DESCRIPTION
EMAX	Erosion strain of element: ϵ_{\max}
EAFAIL	Erosion strain in longitudinal direction (see Figure M214-1): $\epsilon_{a,\text{fail}}$
EBFAIL	Erosion strain in transverse direction (see Figure M214-1): $\epsilon_{b,\text{fail}}$

Remarks:

1. **Strain Rate Effects.** Strain rate effects are accounted for using a Cowper-Symonds model which scales the stress according to the strain rate:

$$\sigma^{\text{adj}} = \sigma \left(1 + \frac{\dot{\epsilon}}{C} \right)^{\frac{1}{P}} .$$

In the above equation σ is the quasi-static stress, σ^{adj} is the adjusted stress accounting for strain rate $\dot{\epsilon}$, and C (CCE) and P (PCE) are the Cowper-Symonds factors which must be determined experimentally for each material.

The model captures the non-linear strain rate effects in many materials. With its less than unity exponent, $1/p$, this model captures the rapid increase in material properties at low strain rate, while increasing less rapidly at very high strain rates. Because stress is a function of strain rate the elastic stiffness also is:

$$\mathbf{E}^{\text{adj}} = \mathbf{E} \left(1 + \frac{\dot{\epsilon}}{C} \right)^{\frac{1}{P}}$$

where \mathbf{E}^{adj} is the adjusted elastic stiffness. Additionally, the strains to peak and strains to failure are assumed to follow a Cowper-Symonds model with, *possibly different*, constants

$$\epsilon^{\text{adj}} = \epsilon \left(1 + \frac{\dot{\epsilon}}{C_s} \right)^{\frac{1}{P_s}} ,$$

where, ϵ^{adj} is the adjusted effective strain to peak stress or strain to failure, and C_s and P_s are CSE and PSE respectively.

2. **Stress-Strain beyond Peak Stress.** When strained beyond the peak stress, the stress decreases linearly until it attains a value equal to SIGPOST, at which point the stress-strain relation becomes nonlinear. In the non-linear region the stress is given by

$$\sigma = \sigma_{\text{post}} \left[1 - \left(\frac{\varepsilon - \varepsilon_{[a/b],\text{post}}}{\varepsilon_{[a/b],\text{fail}} - \varepsilon_{[a/b],\text{post}}} \right)^{d_{\text{fac}}} \right],$$

where σ_{post} and $\varepsilon_{\text{post}}$ are, respectively, the stress and strain demarcating the onset of nonlinear behavior. The value of SIGPOST is the same in both the transverse and longitudinal directions, whereas $\varepsilon_{a,\text{post}}$ and $\varepsilon_{b,\text{post}}$ depend on direction and are derived internally from EASF, EBSF, and SIGPOST. The failure strain, $\varepsilon_{[a/b],\text{fail}}$, specifies the onset of failure and differs in the longitudinal and transverse directions. Lastly the exponent, d_{fac} , determines the shape of nonlinear stress-strain curve between $\varepsilon_{\text{post}}$ and $\varepsilon_{[a/b],\text{fail}}$.

3. **Element Erosion.** The element is eroded if either (a) or (b) is satisfied:

- a) $\varepsilon_a > \varepsilon_{a,\text{fail}}$ and $\varepsilon_b > \varepsilon_{b,\text{fail}}$
- b) $\varepsilon_a > \varepsilon_{\text{max}}$ and $\varepsilon_b > \varepsilon_{\text{max}}$.

***MAT_4A_MICROMECH**

This is Material Type 215. A micromechanical material that distinguishes between a fiber/inclusion and a matrix material, developed by 4a engineering GmbH. It is available for the explicit code for shell, thick shell, and solid elements. Useful hints and an input example can be found in [1]. More theory and application notes are provided in [2].

This material is intended for anisotropic composite materials, especially for short (SFRT) and long fiber thermoplastics (LFRT). The matrix behavior is modeled with an isotropic elasto-viscoplastic von Mises model. The fiber/inclusion behavior is transverse isotropic elastic. This material model can be used for classical endless fiber composites.

The inelastic homogenization for describing the composite deformation behavior is based on:

- Mori Tanaka Meanfield Theory [3,4]
- ellipsoidal inclusions using Eshelby's solution [5,6]
- orientation averaging [7]
- a linear fitted closure approximation to determine the 4th order fiber orientation tensor out of the user provided 2nd order fiber orientation tensor.

The software product 4a micromec can calculate and export the thermo-elastic composite properties [8].

Failure/damage of the composite can be considered with:

- a ductile damage initiation and evolution model for the matrix (DIEM)
- fiber failure with a maximum stress criterion

References [9] and [10] provide more details on the material characterization.

The (fiber) orientation can be defined either for the whole material using Cards 2 and 3 or elementwise using *ELEMENT_(T)SHELL_BETA or *ELEMENT_SOLID_ORTHO. The manufacturing process highly influences the mechanical properties of SFRT and LFRT in injection molded parts. By mapping the fiber orientation from the process simulation to the structural analysis the local anisotropy can be considered [11,12]. The fiber orientation, length and volume fraction can therefore as well be defined for each integration point by using *INITIAL_STRESS_(T)SHELL(SOLID) [2]. Details on the history variables that can be initialized (extra history variables 9-18) can be found in the output section.

Card Summary:

Cards 2 through 4 specify fiber orientation. They may be overwritten with may be overwritten by *INITIAL_STRESS_(T)SHELL/SOLID. Cards 5 and 6 are for specifying parameters for the fiber/inclusion material. Cards 7 through 9 give properties associated with the matrix material.

Card 1. This card is required.

MID	MMOPT	BUPD			FAILM	FAILF	NUMINT
-----	-------	------	--	--	-------	-------	--------

Card 2. This card is required.

AOPT	MACF	XP	YP	ZP	A1	A2	A3
------	------	----	----	----	----	----	----

Card 3. This card is required.

V1	V2	V3	D1	D2	D3	BETA	
----	----	----	----	----	----	------	--

Card 4. This card is required.

FVF		FL	FD		A11	A22	
-----	--	----	----	--	-----	-----	--

Card 5. This card is required.

ROF	EL	ET	GLT	PRTL	PRTT		
-----	----	----	-----	------	------	--	--

Card 6. This card is required.

XT						SLIMXT	NCYRED
----	--	--	--	--	--	--------	--------

Card 7. This card is required.

ROM	E	PR					
-----	---	----	--	--	--	--	--

Card 8. This card is required.

SIGYT	ETANT			EPS0	C		
-------	-------	--	--	------	---	--	--

Card 9. This card is required.

LCIDT				LCDI	UPF		NCYRED2
-------	--	--	--	------	-----	--	---------

Data Card Definitions:

Card 1	1	2	3	4	5	6	7	8
Variable	MID	MMOPT	BUPD			FAILM	FAILF	NUMINT
Type	A	F	F			F	F	F
Default	none	0.0	0.01			0.0	0.0	1.0

VARIABLE**DESCRIPTION**

MID	Material identification. A unique number or label must be specified (see *PART).
MMOPT	Option to define micromechanical material behavior: EQ.0.0: Elastic EQ.1.0: Elastic-plastic
BUPD	Tolerance for update of Strain-Concentration Tensor
FAILM	Option for matrix failure using a ductile DIEM model. See sections Damage Initiation and Damage Evolution in the manual page for *MAT_ADD_DAMAGE_DIEM for a description of ductile damage initialization (DITYP = 0) based on stress triaxiality and a linear damage evolution (DETYP = 0) type. Also see fields LCDI and UPF on Card 9. LT.0.0: FAILM is effective plastic matrix strain at failure. When the matrix plastic strain reaches this value, the element is deleted from the calculation. EQ.0.0: Only visualization (triaxiality of matrix stresses) EQ.1.0: Active DIEM (triaxiality of matrix stresses) EQ.10.0: Only visualization (triaxiality of composite stresses) EQ.11.0: Active DIEM (triaxiality of composite stresses)
FAILF	Option for fiber failure: EQ.0.0: Only visualization (equivalent fiber stresses) EQ.1.0: Active (equivalent fiber stresses)

VARIABLE**DESCRIPTION**

NUMINT

Number or percentage of failed integration points prior to element deletion (default value is 1):

GT.0.0: Number of integration points which must fail before element is deleted.

LT.0.0: Applies only to shells. |NUMINT| is the percentage of layers which must fail before an element fails. For shell formulations with 4 integration points per layer, the layer is considered failed if any of the integration points in the layer fails.

Card 2	1	2	3	4	5	6	7	8
Variable	AOPT	MACF	XP	YP	ZP	A1	A2	A3
Type	F	F	F	F	F	F	F	F
Default	0.0	0	0.0	0.0	0.0	0.0	0.0	0.0

VARIABLE**DESCRIPTION**

AOPT

Material axes option (see MAT_OPTIONTROPIC_ELASTIC for a more complete description):

EQ.0.0: Locally orthotropic with material axes determined by element nodes. For shells only, the material axes are then rotated about the normal vector to the surface of the shell by the angle BETA.

EQ.1.0: Locally orthotropic with material axes determined by a point, P , in space and the global location of the element center. This option is for solid elements only.

EQ.2.0: Globally orthotropic with material axes determined by vectors defined below

VARIABLE**DESCRIPTION**

EQ.3.0: Locally orthotropic material axes determined by a vector \mathbf{v} and the normal vector to the plane of the element. The plane of a solid element is the midsurface between the inner surface and outer surface defined by the first four nodes and the last four nodes of the connectivity of the element, respectively. Thus, for solid elements, AOPT = 3 is only available for hexahedrons. \mathbf{a} is determined by taking the cross product of \mathbf{v} with the normal vector, \mathbf{b} is determined by taking the cross product of the normal vector with \mathbf{a} , and \mathbf{c} is the normal vector. Then \mathbf{a} and \mathbf{b} are rotated about \mathbf{c} by an angle BETA. BETA may be set in the keyword input for the element or in the input for this keyword. Note that for solids, the material axes may be switched depending on the choice of MACF. The switch may occur before or after applying BETA depending on the value of MACF.

EQ.4.0: Locally orthotropic in cylindrical coordinate system with the material axes determined by a vector, \mathbf{v} , and an originating point, P , defining the centerline axis. This option is for solid elements only.

LT.0.0: The absolute value of AOPT is a coordinate system ID number (CID on *DEFINE_COORDINATE_NODES, *DEFINE_COORDINATE_SYSTEM or *DEFINE_COORDINATE_VECTOR).

The fiber orientation information may be overwritten using *INITIAL_STRESS_(T)SHELL/SOLID

VARIABLE	DESCRIPTION
----------	-------------

MACF Material axes change flag for solid elements:

EQ.-4: Switch material axes *b* and *c* before BETA rotation
 EQ.-3: Switch material axes *a* and *c* before BETA rotation
 EQ.-2: Switch material axes *a* and *b* before BETA rotation
 EQ.1: No change, default
 EQ.2: Switch material axes *a* and *b* after BETA rotation
 EQ.3: Switch material axes *a* and *c* after BETA rotation
 EQ.4: Switch material axes *b* and *c* after BETA rotation

Figure M2-2 indicates when LS-DYNA applies MACF during the process to obtain the final material axes. If BETA on *ELEMENT_-SOLID_{OPTION} is defined, then that BETA is used for the rotation for all AOPT options. Otherwise, if AOPT = 3, the BETA input on Card 3 rotates the axes. For all other values of AOPT, the material axes will be switched as specified by MACF, but no BETA rotation will be performed.

XP, YP, ZP Coordinates of point *p* for AOPT = 1 and 4
 A1, A2, A3 Components of vector **a** for AOPT = 2

Card 3	1	2	3	4	5	6	7	8
Variable	V1	V2	V3	D1	D2	D3	BETA	
Type	F	F	F	F	F	F	F	
Default	0.0	0.0	0.0	0.0	0.0	0.0	0.0	

VARIABLE	DESCRIPTION
----------	-------------

V1, V2, V3 Define components of vector **v** for AOPT = 3 and 4.
 D1, D2, D3 Define components of vector **d** for AOPT = 2.

VARIABLE**DESCRIPTION**

BETA

Angle in degrees of a material rotation about the *c*-axis, available for AOPT = 0 (shells and tshells only) and AOPT = 3 (all element types). This angle may be overridden on the element card; see *ELEMENT_SHELL_BETA, *ELEMENT_TSHELL_BETA, and *ELEMENT_SOLID_ORTHO.

Card 4	1	2	3	4	5	6	7	8
Variable	FVF		FL	FD		A11	A22	
Type	F		F	F		F	F	
Default	0.0		0.0	1.0		1.0	0.0	

VARIABLE**DESCRIPTION**

FVF

Fiber volume or mass fraction:

GT.0.0: Fiber volume fraction

LT.0.0: |FVF| is the fiber mass fraction.

FL

Fiber length unless FD = 1. If FD = 1, then it is the aspect ratio (may be overwritten by *INITIAL_STRESS_(T)SHELL/SOLID)

FD

Fiber diameter

A11

Value of first principal fiber orientation (may be overwritten by *INITIAL_STRESS_(T)SHELL/SOLID)

A22

Value of second principal fiber orientation (may be overwritten by *INITIAL_STRESS_(T)SHELL/SOLID)

Card 5	1	2	3	4	5	6	7	8
Variable	ROF	EL	ET	GLT	PRTL	PRTT		
Type	F	F	F	F	F	F		
Default	0.0	0.0	0.0	0.0	0.0	0.0		

VARIABLE	DESCRIPTION
ROF	Mass density of fiber
EL	E_L , Young's modulus of fiber in the longitudinal direction
ET	E_T , Young's modulus of fiber in the transverse direction
GLT	G_{LT} , shear modulus LT
PRTL	ν_{TL} , Poisson's ratio TL
PRTT	ν_{TT} , Poisson's ratio TT

Card 6	1	2	3	4	5	6	7	8
Variable	XT						SLIMXT	NCYRED
Type	F						F	F
Default	0.0						0.0	10

VARIABLE	DESCRIPTION
XT	Fiber tensile strength in the longitudinal direction
SLIMXT	Factor to determine the minimum stress limit in the fiber after stress maximum (fiber tension)
NCYRED	Number of cycles for stress reduction from maximum to minimum (fiber tension)

Card 7	1	2	3	4	5	6	7	8
Variable	ROM	E	PR					
Type	F	F	F					
Default	0.0	0.0	0.0					

VARIABLE	DESCRIPTION							
-----------------	--------------------	--	--	--	--	--	--	--

ROM	Mass density of matrix							
E	Young's modulus of matrix							
PR	Poisson's ratio of matrix							

Card 8	1	2	3	4	5	6	7	8
Variable	SIGYT	ETANT			EPS0	C		
Type	F	F			F	F		
Default	0.0	0.0			0.0	0.0		

VARIABLE	DESCRIPTION							
-----------------	--------------------	--	--	--	--	--	--	--

SIGYT	Yield stress of matrix in tension							
ETANT	Tangent modulus of matrix in tension, ignore if LCIDT > 0 is defined.							
EPS0	Quasi-static threshold strain rate (Johnson-Cook model) for bilinear hardening							
C	Johnson-Cook constant for bilinear hardening							

Card 9	1	2	3	4	5	6	7	8
Variable	LCIDT				LCDI	UPF		NCYRED2
Type	F				F	F		F
Default	0				0	0.0		1

VARIABLE	DESCRIPTION							
-----------------	--------------------	--	--	--	--	--	--	--

LCIDT	Load curve ID or table ID for defining effective stress as a function of effective plastic strain in tension of matrix material (Table to include strain-rate effects, viscoplastic formulation.)							
-------	---	--	--	--	--	--	--	--

VARIABLE	DESCRIPTION
LCDI	<p>Curve/table for ductile damage initiation parameter. The definitions depend on if the element is a shell or solid.</p> <p>Shell elements. LCDI can be a load curve or table ID. A load curve represents plastic strain at onset of damage as function of stress triaxiality. A table represents plastic strain at onset of damage as function of stress triaxiality and plastic strain rate.</p> <p>Solid elements. LCDI can be a load curve, table, or 3D table ID. A load curve represents plastic strain at onset of damage as function of stress triaxiality. A table represents plastic strain at onset of damage as function of stress triaxiality and lode angle. A 3D table represents plastic strain at onset of damage as function of stress triaxiality, lode angle and plastic strain rate.</p>
UPF	<p>Damage evolution parameter</p> <p>GT.0.0: Plastic displacement at failure, u_f^p</p> <p>LT.0.0: UPF is a table ID for u_f^p as a function of triaxiality and damage</p>
NCYRED2	<p>In case of matrix failure (IFAILM = 1 or 11), number of cycles for stress reduction of fiber stresses until the integration point will be marked as failed.</p>

Output:

For this material, "Plastic Strain" is the equivalent plastic strain in the matrix. Extra history variables may be requested for (t)shell (NEIPS) and solid (NEIPH) elements with *DATABASE_EXTENT_BINARY. Extra history variables 1 through 8 are intended for post-processing while 9 through 18 are intended for initialization with *INITIAL_STRESS_(T)SHELL/SOLID. They have the following meaning:

History Variable #	Description
1	Equivalent plastic strain rate of matrix
2	Triaxiality of matrix, $\eta = -p/q$
3	Lode parameter of matrix, $\xi = -\frac{27J_3}{2q}$
4	Damage initiation, d , of matrix (Ductile Criteria)

History Variable #	Description
5	Damage evolution, D , of matrix
6	Fiber reserve factor
7	Fiber damage variable
8	Fiber stress reduction variable (NCYRED2)
9	Value of first principal fiber orientation, A11
10	Value of second principal fiber orientation, A22
11	For shells, $\cos \alpha$ where α is the in-plane angle between the material coordinate system and the element coordinate system. For solids, q_{11} where q_{11} is the x -direction component of the first orientation direction in the element coordinate system.
12	For shells, $-\sin \alpha$ where α is the in-plane angle between the material coordinate system and the element coordinate system. For solids, q_{12} where q_{12} is the y -direction component of the first orientation direction in the element coordinate system.
13	For shells, unused. For solids, q_{13} where q_{13} is the z -direction component of the first orientation direction in the element coordinate system.
14	For shells, unused. For solids, q_{31} where q_{31} is the x -direction component of the third orientation direction in the element coordinate system.
15	For shells, unused. For solids, q_{32} where q_{32} is the y -direction component of the third orientation direction in the element coordinate system.
16	For shells, unused. For solids, q_{33} where q_{33} is the z -direction component of the third orientation direction in the element coordinate system.
17	Fiber volume fraction, FVF
18	Fiber length, FL

Material Orientation:

Figure 4 of Reference 13 shows the 2nd order orientation tensor for which there are eigenvectors and corresponding eigenvalues. The coordinate system based on the eigenvectors is the material coordinate system. The values q_{11}, \dots, q_{33} for solids (history variables 11 through 16) and the values $\cos(\alpha)$ and $-\sin \alpha$ for shells (history variables 11 and 12) specify this material coordinate system with respect to the element coordinate system. The values a_1 and a_2 (A_{11} and A_{22} of history variables 9 and 10) shown in the figure represent the eigenvalues, or in other words, the lengths of the ellipsoid. Thus, history variables 9 and 10 give the shape of the ellipsoid while history variables 11 through 16 give the orientation.

References:

- [1] Reithofer, P., et. al, *MAT_4A_MICROMECH – micro mechanic based material model, 14th German LS-DYNA Conference (2016), Bamberg.
- [2] Reithofer, P., et. al, *MAT_4A_MICROMECH – Theory and application notes, 11th European LS-DYNA Conference (2017), Salzburg.
- [3] Mori, T., Tanaka, K., Average Stress in Matrix and Average elastic Energy of Materials with misfitting Inclusions, Acta Metallurgica, Vol.21, pp.571-574, (1973).
- [4] Tucker Ch. L. III, Liang Erwin: Stiffness Predictions for Unidirectional Short-Fibre Composites: Review and Evaluation, Composites Science and Technology, 59, (1999).
- [5] Maewal A., Dandekar D.P., Effective Thermoelastic Properties of Short-Fibre Composites, Acta Mechanica, 66, (1987).
- [6] Eshelby, J. D., The determination of the elastic field of an ellipsoidal inclusion, and related problems, Proceedings of the Royal Society, London, Vol.A, No241, pp.376-396, (1957).
- [7] Mlekusch, B., Kurzfaserverstärkte Thermoplaste, Dissertation, Montanuniversität Leoben (1997).
- [8] <http://micromec.4a.co.at>
- [9] Reithofer et al., *Material characterization of composites using micro mechanic models as key enabler*, NAFEMS DACH, Bamberg 2016.
- [10] <http://impetus.4a.co.at>
- [11] Reithofer et al., *Short and long fiber reinforced thermoplastics material models in LS-DYNA*, 10th European LS-DYNA Conference, Würzburg 2015.
- [12] <http://fibermap.4a.co.at>
- [13] Liebold et al., *The Significance of the Production Process of FRP Parts for the Performance in Crashworthiness*, 14th International LS-DYNA Users Conference, 2016, <http://www.dyna-look.com/14th-international-ls-dyna-conference/simulation/the-significance-of-the-production-process-of-frp-parts-for-the-performance-in-crashworthiness>

***MAT_ELASTIC_PHASE_CHANGE**

This is Material Type 216, a generalization of Material Type 1, for which material properties change on an element-by-element basis upon crossing a plane in space. This is an isotropic hypoelastic material and is available *only* for shell element types.

Phase 1 Properties.

Card 1	1	2	3	4	5	6	7	8
Variable	MID	R01	E1	PR1				
Type	A8	F	F	F				
Default	none	none	none	0.0				

Phase 2 Properties.

Card 2	1	2	3	4	5	6	7	8
Variable		R02	E2	PR2				
Type		F	F	F				
Default		none	none	0.0				

Transformation Plane Card.

Card 3	1	2	3	4	5	6	7	8
Variable	X1	Y1	Z1	X2	Y2	Z2	THKFAC	
Type	F	F	F	F	F	F	F	
Default	none	none	none	none	none	none	1.0	

VARIABLE	DESCRIPTION
MID	Material identification. A unique number or label not exceeding 8 characters must be specified.
RO_i	Mass density for phase i
E_i	Young's modulus for phase i
PR_i	Poisson's ratio for phase i
X1, Y1, Z1	Coordinates of a point on the phase transition plane
X2, Y2, Z2	Coordinates of a point that defines the exterior normal with the first point
THKFAC	Scale factor applied to the shell thickness after the phase transformation

Phases:

The material properties for each element are initialized using the data for the first phase. After the center of the element passes through the transition plane defined by the two points, the material properties are irreversibly changed to the second phase.

The plane is defined by two points. The first point, coordinates X1, Y1, and Z1, lies on the plane. The second point, coordinates X2, Y2, and Z2, defines the exterior normal as a unit vector in the direction from the first point to the second point.

Remarks:

This hypoelastic material model may not be stable for finite (large) strains. If large strains are expected, a hyperelastic material model, such as *MAT_002 or *MAT_217, would be more appropriate.

***MAT_ORTHOTROPIC_ELASTIC_PHASE_CHANGE**

This is Material Type 217. It is a generalization of the orthotropic version of Material Type 2 for which material properties change on an element-by-element basis upon crossing a plane in space.

This material is valid *only* for shells. The stress update is incremental. The elastic constants are formulated in terms of Cauchy stress and true strain.

Phase 1 Material Parameters Card 1.

Card 1	1	2	3	4	5	6	7	8
Variable	MID	R01	EA1	EB1	EC1	PRBA1	PRCA1	PRCB1
Type	A	F	F	F	F	F	F	F

Phase 1 Material Parameters Card 2.

Card 2	1	2	3	4	5	6	7	8
Variable	GAB1	GBC1	GCA1	AOPT1				
Type	F	F	F	F				

Local Coordinate System Card 1 (phase 1).

Card 3	1	2	3	4	5	6	7	8
Variable				A11	A21	A31		
Type				F	F	F		

Local Coordinate System Card 2 (phase 1).

Card 4	1	2	3	4	5	6	7	8
Variable	V11	V21	V31	D11	D21	D31	BETA1	
Type	F	F	F	F	F	F	F	

Phase 2 Material Parameters Card 1.

Card 5	1	2	3	4	5	6	7	8
Variable		R02	EA2	EB2	EC2	PRBA2	PRCA2	PRCB2
Type		F	F	F	F	F	F	F

Phase 2 Material Parameters Card 2.

Card 6	1	2	3	4	5	6	7	8
Variable	GAB2	GBC2	GCA2					
Type	F	F	F					

Local Coordinate System Card 1 (phase 2).

Card 7	1	2	3	4	5	6	7	8
Variable				A12	A22	A32		
Type				F	F	F		

Local Coordinate System Card 2 (phase 2).

Card 8	1	2	3	4	5	6	7	8
Variable	V12	V22	V32	D12	D22	D32	BETA2	
Type	F	F	F	F	F	F	F	

Transformation Plane Card.

Card 9	1	2	3	4	5	6	7	8
Variable	X1	Y1	Z1	X2	Y2	Z2	THKFAC	
Type	F	F	F	F	F	F	F	
Default	none	none	none	none	none	none	1.0	

VARIABLE**DESCRIPTION**

MID	Material identification. A unique number or label must be specified (see *PART).
RO _{<i>i</i>}	Mass density for phase <i>i</i>
E _{A_{<i>i</i>}}	E_a , Young's modulus in <i>a</i> -direction for phase <i>i</i>
E _{B_{<i>i</i>}}	E_b , Young's modulus in <i>b</i> -direction for phase <i>i</i>
E _{C_{<i>i</i>}}	E_c , Young's modulus in <i>c</i> -direction phase <i>i</i> (nonzero value required but not used for shells)
PRBA _{<i>i</i>}	ν_{ba} , Poisson's ratio in the <i>ba</i> direction for phase <i>i</i>
PRCA _{<i>i</i>}	ν_{ca} , Poisson's ratio in the <i>ca</i> direction for phase <i>i</i>
PRCB _{<i>i</i>}	ν_{cb} , Poisson's ratio in the <i>cb</i> direction for phase <i>i</i>
GAB _{<i>i</i>}	G_{ab} , shear modulus in the <i>ab</i> direction for phase <i>i</i>
GBC _{<i>i</i>}	G_{bc} , shear modulus in the <i>bc</i> direction for phase <i>i</i>
GCA _{<i>i</i>}	G_{ca} , shear modulus in the <i>ca</i> direction for phase <i>i</i>
AOPT _{<i>i</i>}	Material axes option for phase <i>i</i> (see *MAT_OPTIONTROPIC for more details):

EQ.0.0: Locally orthotropic with material axes determined by element nodes as shown in part (a) of [Figure M2-1](#). The **a**-direction is from node 1 to node 2 of the element. The **b**-direction is orthogonal to the **a**-direction and is in the plane formed by nodes 1, 2, and 4. The material axes are then rotated about the normal vector to the surface of the shell by the angle BETA.

EQ.2.0: Globally orthotropic with material axes determined by vectors defined below, as with *DEFINE_COORDINATE_VECTOR.

EQ.3.0: Locally orthotropic material axes determined by a vector **v** and the normal vector to the plane of the element. **a** is determined by taking the cross product of **v** with the normal vector, **b** is determined by taking the cross product of the normal vector with **a**, and **c** is the normal vector. Then, **a** and **b** are rotated about **c** by an angle BETA.

LT.0.0: |AOPT| is a coordinate system ID (CID on *DEFINE_COORDINATE_NODES, *DEFINE_COORDINATE_SYSTEM or *DEFINE_COORDINATE_VECTOR).

A1i, A2i, A3i	Define components of the <i>i</i> th phase's vector a for AOPT = 2
V1i, V2i, V3i	Define components of the <i>i</i> th phase's vector v for AOPT = 3
D1i, D2i, D3i	Define components of the <i>i</i> th phase's vector d for AOPT = 2
BETAi	Material angle of <i>i</i> th phase in degrees for AOPT = 3. It may be overridden on the element card; see *ELEMENT_SHELL_BETA.
X1, Y1, Z1	Coordinates of a point on the phase transition page
X2, Y2, Z2	Coordinates of a point that defines the exterior normal with the first point
THKFAC	Scale factor applied to the shell thickness after the phase transformation.

Phases:

The material properties for each element are initialized using the data for the first phase. After the center of the element passes through the transition plane defined by the two points, the material properties are irreversibly changed to the second phase.

The plane is defined by two points. The first point, defined by the coordinates X1, Y1, and Z1, lies on the plane. The second point, defined by the coordinates X2, Y2, and Z2, define the exterior normal as a unit vector in the direction from the first point to the second point.

Material Formulation:

The material law that relates stresses to strains is defined as:

$$\mathbf{C} = \mathbf{T}^T \mathbf{C}_L \mathbf{T}$$

where \mathbf{T} is a transformation matrix, and \mathbf{C}_L is the constitutive matrix defined in terms of the material constants of the orthogonal material axes, $\{\mathbf{a}, \mathbf{b}, \mathbf{c}\}$. The inverse of \mathbf{C}_L is defined as:

$$\mathbf{C}_L^{-1} = \begin{bmatrix} \frac{1}{E_a} & -\frac{\nu_{ba}}{E_b} & -\frac{\nu_{ca}}{E_c} & 0 & 0 & 0 \\ -\frac{\nu_{ab}}{E_a} & \frac{1}{E_b} & -\frac{\nu_{cb}}{E_c} & 0 & 0 & 0 \\ -\frac{\nu_{ac}}{E_a} & -\frac{\nu_{bc}}{E_b} & \frac{1}{E_c} & 0 & 0 & 0 \\ 0 & 0 & 0 & \frac{1}{G_{ab}} & 0 & 0 \\ 0 & 0 & 0 & 0 & \frac{1}{G_{bc}} & 0 \\ 0 & 0 & 0 & 0 & 0 & \frac{1}{G_{ca}} \end{bmatrix}$$

where,

$$\frac{\nu_{ab}}{E_a} = \frac{\nu_{ba}}{E_b}, \frac{\nu_{ca}}{E_c} = \frac{\nu_{ac}}{E_a}, \frac{\nu_{cb}}{E_c} = \frac{\nu_{bc}}{E_b}.$$

*MAT_MOONEY-RIVLIN_PHASE_CHANGE

This is Material Type 218, a generalization of Material Type 27, for which material properties change on an element-by-element basis upon crossing a plane in space.

Phase 1 Card 1.

Card 1	1	2	3	4	5	6	7	8
Variable	MID	R01	PR1	A1	B1	REF		
Type	A8	F	F	F	F	F		

Phase 1 Card 2.

Card 2	1	2	3	4	5	6	7	8
Variable	SGL1	SW1	ST1	LCID1				
Type	F	F	F	F				

Phase 2 Card 1.

Card 3	1	2	3	4	5	6	7	8
Variable		R02	PR2	A2	B2			
Type		F	F	F	F			

Phase 2 Card 2.

Card 4	1	2	3	4	5	6	7	8
Variable	SGL2	SW2	ST2	LCID2				
Type	F	F	F	F				

Transformation Plane Card.

Card 5	1	2	3	4	5	6	7	8
Variable	X1	Y1	Z1	X2	Y2	Z2	THKFAC	
Type	F	F	F	F	F	F	F	
Default	none	none	none	none	none	none	1.0	

VARIABLE**DESCRIPTION**

MID	Material identification. A unique number or label not exceeding 8 characters must be specified.
RO _{<i>i</i>}	Mass density for phase <i>i</i> .
PR _{<i>i</i>}	Poisson's ratio (value between 0.49 and 0.5 is recommended, smaller values may not work) where <i>i</i> indicates the phase.
A _{<i>i</i>}	Constant for the <i>i</i> th phase, see literature and equations defined below.
B _{<i>i</i>}	Constant for the <i>i</i> th phase, see literature and equations defined below.
REF	Use reference geometry to initialize the stress tensor. The reference geometry is defined by the keyword:*INITIAL_FOAM_REFERENCE_GEOMETRY (see there for more details). EQ.0.0: off, EQ.1.0: on.

If $A = B = 0.0$, then a least square fit is computed from tabulated uniaxial data via a load curve. The following information should be defined:

VARIABLE	DESCRIPTION
----------	-------------

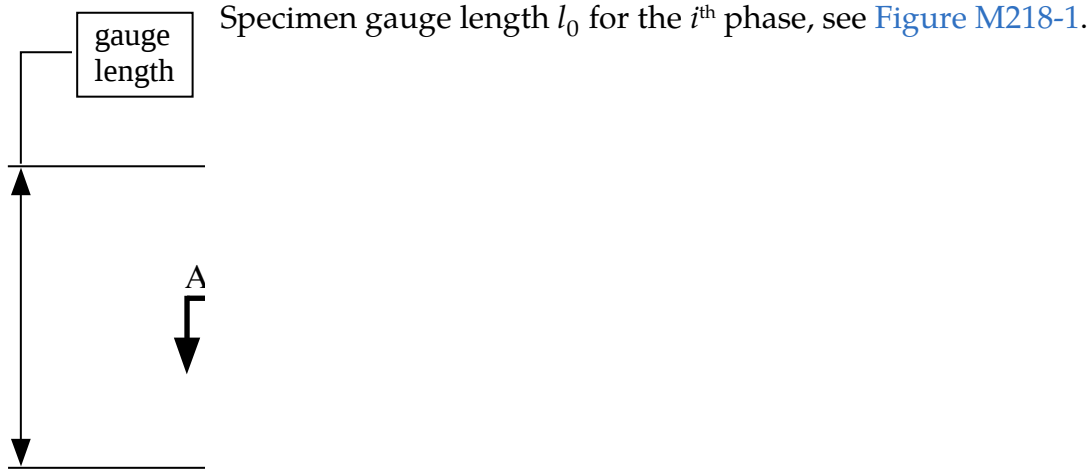

Figure M

SGL_i	
SW_i	Specimen width for the i^{th} phase, see Figure M218-1 .
ST_i	Specimen thickness for the i^{th} phase, see Figure M218-1 .
$LCID_i$	Curve ID for the i^{th} phase, see *DEFINE_CURVE, giving the force versus actual change ΔL in the gauge length. See also Figure M218-2 for an alternative definition.
$X1, Y1, Z1$	Coordinates of a point on the phase transition plane.
$X2, Y2, Z2$	Coordinates of a point that defines the exterior normal with the first point.
THKFAC	Scale factor applied to the shell thickness after the phase transformation.

Phases:

The material properties for each element are initialized using the data for the first phase. After the center of the element passes through the transition plane defined by the two points, the material properties are irreversibly changed to the second phase.

The plane is defined by two points. The first point, defined by the coordinates $X1$, $Y1$, and $Z1$, lies on the plane. The second point, defined by the coordinates $X2$, $Y2$, and $Z2$, define the exterior normal as a unit vector in the direction from the first point to the second point.

Material Formulation:

The strain energy density function is defined as:

$$W = A(I - 3) + B(II - 3) + C(III^{-2} - 1) + D(III - 1)^2$$

where

$$\begin{aligned} C &= 0.5 A + B \\ D &= \frac{A(5\nu - 2) + B(11\nu - 5)}{2(1 - 2\nu)} \\ \nu &= \text{Poisson's ratio} \\ 2(A + B) &= \text{shear modulus of linear elasticity} \\ I, II, III &= \text{invariants of right Cauchy-Green Tensor } C. \end{aligned}$$

The load curve definition that provides the uniaxial data should give the change in gauge length, ΔL , versus the corresponding force. In compression both the force and the change in gauge length must be specified as negative values. In tension the force and change in gauge length should be input as positive values. The principal stretch ratio in the uniaxial direction, λ_1 , is then given by

$$\lambda_1 = \frac{L_0 + \Delta L}{L_0}$$

with L_0 being the initial length and L being the actual length.

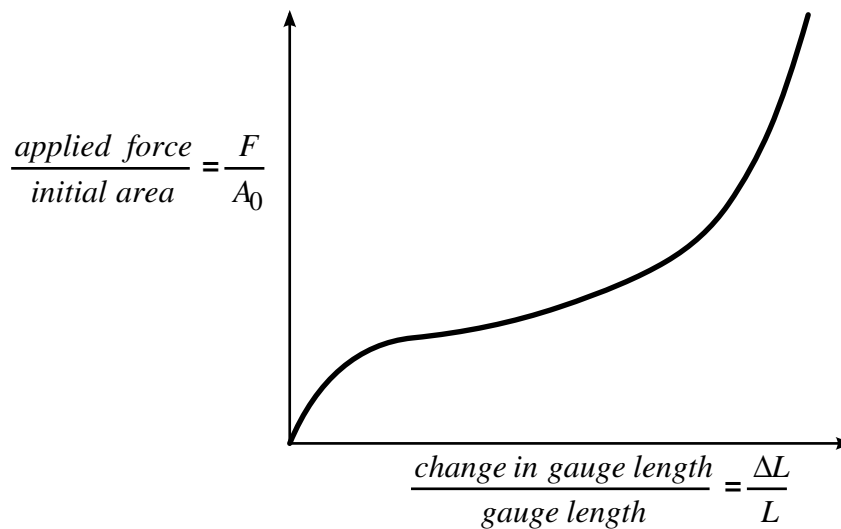

Figure M218-2 The stress versus strain curve can be used instead of the force versus the change in the gauge length by setting the gauge length, thickness, and width to unity (1.0) and defining the engineering strain in place of the change in gauge length and the nominal (engineering) stress in place of the force. *MAT_077_O is a better alternative for fitting data resembling the curve above. *MAT_027 will provide a poor fit to a curve that exhibits a strong upturn in slope as strains become large.

Alternatively, the stress versus strain curve can also be input by setting the gauge length, thickness, and width to unity (1.0) and defining the engineering strain in place of the change in gauge length and the nominal (engineering) stress in place of the force, see [Figure M218-1](#).

The least square fit to the experimental data is performed during the initialization phase and a comparison between the fit and the actual input is provided in the d3hsp file. It is a good idea to visually check to make sure it is acceptable. The coefficients A and B are also printed in the output file. It is also advised to use the material driver (see Appendix K) for checking out the material model.

***MAT_CODAM2**

This is Material Type 219. This material model is the second generation of the UBC Composite Damage Model (CODAM2) for solid, shell, and thick shell elements developed at The University of British Columbia. The model is a sub-laminate-based continuum damage mechanics model for fiber reinforced composite laminates made up of transversely isotropic layers. The material model includes an optional non-local averaging and element erosion.

Card Summary:

Card 1. This card is required.

MID	RO	EA	EB		PRBA		PRCB
-----	----	----	----	--	------	--	------

Card 2. This card is required.

GAB			NLAYER	R1	R2	NFREQ	
-----	--	--	--------	----	----	-------	--

Card 3. This card is required.

XP	YP	ZP	A1	A2	A3	AOPT	
----	----	----	----	----	----	------	--

Card 4. This card is required.

V1	V2	V3	D1	D2	D3	BETA	MACF
----	----	----	----	----	----	------	------

Card 5. For each of the NLAYER layers specify on angle. Include as many cards as needed to set NLAYER values.

ANGLE1	ANGLE2	ANGLE3	ANGLE4	ANGLE5	ANGLE6	ANGLE7	ANGLE8
--------	--------	--------	--------	--------	--------	--------	--------

Card 6. This card is required.

IMATT	IFIBT	ILOCT	IDELT	SMATT	SFIBT	SLOCT	SDELT
-------	-------	-------	-------	-------	-------	-------	-------

Card 7. This card is required.

IMATC	IFIBC	ILOCC	IDELC	SMATC	SFIBC	SLOCC	SDELC
-------	-------	-------	-------	-------	-------	-------	-------

Card 8. This card is required.

ERODE	ERPAR1	ERPAR2	RESIDS				
-------	--------	--------	--------	--	--	--	--

Data Card Definitions:

Card 1	1	2	3	4	5	6	7	8
Variable	MID	RO	EA	EB		PRBA		PRCB
Type	A	F	F	F		F		F
Default	none	none	none	none		none		none

VARIABLE**DESCRIPTION**

MID	Material identification. A unique number or label must be specified (see *PART).
RO	Mass density
EA	E_a , Young's modulus in a -direction. This is the modulus along the direction of fibers.
EB	E_b , Young's modulus in b -direction. This is the modulus transverse to fibers.
PRBA	ν_{ba} , Poisson's ratio, ba (minor in-plane Poisson's ratio).
PRCB	ν_{cb} , Poisson's ratio, cb (Poisson's ratio in the plane of isotropy).

Card 2	1	2	3	4	5	6	7	8
Variable	GAB			NLAYER	R1	R2	NFREQ	
Type	F			I	F	F	I	
Default	none			0	0.0	0.0	0	

VARIABLE**DESCRIPTION**

GAB	G_{ba} , Shear modulus, ab (in-plane shear modulus).
NLAYER	Number of layers in the sub-laminate excluding symmetry. As an example, in a $[0/45/-45/90]_{3s}$, NLAYER = 4.

VARIABLE	DESCRIPTION
R1	Non-local averaging radius
R2	Currently not used
NFREQ	Number of time steps between update of neighbor list for nonlocal smoothing. EQ.0: do only one search at the start of the calculation.

Card 3	1	2	3	4	5	6	7	8
Variable	XP	YP	ZP	A1	A2	A3	AOPT	
Type	F	F	F	F	F	F	I	
Default	0.0	0.0	0.0	0.0	0.0	0.0	0	

VARIABLE	DESCRIPTION
XP, YP, ZP	Coordinates of point p for AOPT = 1 and 4.
A1, A2, A3	Components of vector \mathbf{a} for AOPT = 2.
AOPT	Material axes option (see MAT_OPTION-TROPIC_ELASTIC, particularly the Material Directions section, for details): <p>EQ.0.0: Locally orthotropic with material axes determined by element nodes 1, 2, and 4, as with *DEFINE_COORDINATE_NODES. For shells only, the material axes are then rotated about the normal vector to the surface of the shell by the angle BETA.</p> <p>EQ.1.0: Locally orthotropic with material axes determined by a point, P, in space and the global location of the element center; this is the \mathbf{a}-direction. This option is for solid elements only.</p> <p>EQ.2.0: Globally orthotropic with material axes determined by vectors defined below, as with *DEFINE_COORDINATE_VECTOR</p>

VARIABLE	DESCRIPTION							
	<p>EQ.3.0: Locally orthotropic material axes determined by a vector \mathbf{v} and the normal vector to the plane of the element. The plane of a solid element is the midsurface between the inner surface and outer surface defined by the first four nodes and the last four nodes of the connectivity of the element, respectively. Thus, for solid elements, AOPT = 3 is only available for hexahedrons. \mathbf{a} is determined by taking the cross product of \mathbf{v} with the normal vector, \mathbf{b} is determined by taking the cross product of the normal vector with \mathbf{a}, and \mathbf{c} is the normal vector. Then \mathbf{a} and \mathbf{b} are rotated about \mathbf{c} by an angle BETA. BETA may be set in the keyword input for the element or in the input for this keyword. Note that for solids, the material axes may be switched depending on the choice of MACF. The switch may occur before or after applying BETA depending on the value of MACF.</p> <p>EQ.4.0: Locally orthotropic in a cylindrical coordinate system with the material axes determined by a vector \mathbf{v}, and an originating point, P, which define the centerline axis. This option is for solid elements only.</p> <p>LT.0.0: The absolute value of AOPT is a coordinate system ID number (CID on *DEFINE_COORDINATE_OPTION).</p>							

Card 4	1	2	3	4	5	6	7	8
Variable	V1	V2	V3	D1	D2	D3	BETA	MACF
Type	F	F	F	F	F	F	F	I
Default	0.0	0.0	0.0	0.0	0.0	0.0	0.0	0

VARIABLE	DESCRIPTION
V1, V2, V3	Components of vector \mathbf{v} for AOPT = 3 and 4

VARIABLE	DESCRIPTION
D1, D2, D3	Components of vector d for AOPT = 2
BETA	Material angle in degrees for AOPT = 0 (shells only) and AOPT = 3. BETA be overridden on the element card; see *ELEMENT_SHELL_BETA or *ELEMENT_SOLID_ORTHO.
MACF	Material axes change flag for solid elements: EQ.-4: Switch material axes <i>b</i> and <i>c</i> before BETA rotation EQ.-3: Switch material axes <i>a</i> and <i>c</i> before BETA rotation EQ.-2: Switch material axes <i>a</i> and <i>b</i> before BETA rotation EQ.1: No change, default EQ.2: Switch material axes <i>a</i> and <i>b</i> after BETA rotation EQ.3: Switch material axes <i>a</i> and <i>c</i> after BETA rotation EQ.4: Switch material axes <i>b</i> and <i>c</i> after BETA rotation

Figure M2-2 indicates when LS-DYNA applies MACF during the process to obtain the final material axes. If BETA on *ELEMENT_SOLID_{OPTION} is defined, then that BETA is used for the rotation for all AOPT options. Otherwise, if AOPT = 3, the BETA input on Card 4 rotates the axes. For all other values of AOPT, the material axes will be switched as specified by MACF, but no BETA rotation will be performed.

Angle Cards. For each of the NLAYER layers specify on angle. Include as many cards as needed to set NLAYER values.

Card 5	1	2	3	4	5	6	7	8
Variable	ANGLE1	ANGLE2	ANGLE3	ANGLE4	ANGLE5	ANGLE6	ANGLE7	ANGLE8
Type	F	F	F	F	F	F	F	F

VARIABLE**DESCRIPTION**ANGLE_{*i*}

Rotation angle in degrees of layers with respect to the material axes. Input one for each layer.

Card 6	1	2	3	4	5	6	7	8
Variable	IMATT	IFIBT	ILOCT	IDELT	SMATT	SFIBT	SLOCT	SDELT
Type	F	F	F	F	F	F	F	F

VARIABLE**DESCRIPTION**

IMATT

Initiation strain for damage in matrix (transverse) under tensile condition

IFIBT

Initiation strain for damage in the fiber (longitudinal) under tensile condition

ILOCT

Initiation strain for the anti-locking mechanism. This parameter should be equal to the saturation strain for the fiber damage mechanism under tensile condition.

IDELT

Not working in the current version. Can be used for visualization purpose only.

SMATT

Saturation strain for damage in matrix (transverse) under tensile condition

SFIBT

Saturation strain for damage in the fiber (longitudinal) under tensile condition

SLOCT

Saturation strain for the anti-locking mechanism under tensile condition. The recommended value for this parameter is ILOCT + 0.02.

SDELT

Not working in the current version. Can be used for visualization purpose only.

Card 7	1	2	3	4	5	6	7	8
Variable	IMATC	IFIBC	ILOCC	IDELC	SMATC	SFIBC	SLOCC	SDELCL
Type	F	F	F	F	F	F	F	F

VARIABLE**DESCRIPTION**

IMATC	Initiation strain for damage in matrix (transverse) under compressive condition
IFIBC	Initiation strain for damage in the fiber (longitudinal) under compressive condition
ILOCC	Initiation strain for the anti-locking mechanism. This parameter should be equal to the saturation strain for the fiber damage mechanism under compressive condition.
IDELC	Initiation strain for delamination. Not working in the current version. Can be used for visualization purpose only.
SMATC	Saturation strain for damage in matrix (transverse) under compressive condition
SFIBC	Saturation strain for damage in the fiber (longitudinal) under compressive condition
SLOCC	Saturation strain for the anti-locking mechanism under compressive condition. The recommended value for this parameter is ILOCC + 0.02.
SDELCL	Delamination strain. Not working in the current version. Can be used for visualization purpose only.

Card 8	1	2	3	4	5	6	7	8
Variable	ERODE	ERPAR1	ERPAR2	RESIDS				
Type	I	F	F	F				
Default	0	none	none	0.0				

VARIABLE	DESCRIPTION
ERODE	Erosion Flag (see Element Erosion in the remarks) EQ.0: erosion is turned off. EQ.1: non-local strain based erosion criterion EQ.2: local strain based erosion criterion EQ.3: use both ERODE = 1 and ERODE = 2 criteria.
ERPAR1	The erosion parameter #1 used in ERODE types 1 and 3. ERPAR1 \geq 1.0. The recommended value of ERPAR1 is 1.2.
ERPAR2	The erosion parameter #2 used in ERODE types 2 and 3. The recommended value is five times SLOCC defined in Card 7.
RESIDS	Residual strength for layer damage

Model Description:

CODAM2 is developed for modeling the nonlinear, progressive damage behavior of laminated fiber-reinforced plastic materials. The model is based on the work by (Forghani, 2011; Forghani et al. 2011a; Forghani et al. 2011b) and is an extension of the original model, CODAM (Williams et al. 2003).

Briefly, the model uses a continuum damage mechanics approach and the following assumptions have been made in its development:

1. The material is an orthotropic medium consisting of a number of repeating units through the thickness of the laminate, called sub-laminates. For example, $[0/\pm 45/90]$ is in a $[0/\pm 45/90]_{8S}$ laminate.
2. The nonlinear behavior of the composite sub-laminate is only caused by damage evolution. Nonlinear elastic or plastic deformations are not considered.

Formulation:

The in-plane secant stiffness of the damaged laminate is represented as the summation of the effective contributions of the layers in the laminate as shown.

$$\mathbf{A}^d = \sum t_k \mathbf{T}_k^T \mathbf{Q}_k^d \mathbf{T}_k$$

where \mathbf{T}_k is the transformation matrix for the strain vector, and \mathbf{Q}_k^d is the in-plane secant stiffness of k^{th} layer in the principal orthotropic plane, and t_k is the thickness of the k^{th} layer of an n -layered laminate.

A physically-based and yet simple approach has been employed here to derive the damaged stiffness matrix. Two reduction coefficients, R_f and R_m , that represent the reduction of stiffness in the longitudinal (fiber) and transverse (matrix) directions have been employed. The shear modulus has also been reduced by the matrix reduction parameter. The major and minor Poisson's ratios have been reduced by R_f and R_m respectively. A sub-laminate-level reduction, R_L , is incorporated to avoid spurious stress locking in the damaged zone. This would lead to an effective reduced stiffness matrix \mathbf{Q}_k^d . The reduction coefficients are equal to 1 in the undamaged condition and gradually decrease to 0 for a saturated damage condition.

$$\mathbf{Q}_k^d = R_L \begin{bmatrix} \frac{(R_f)_k E_1}{1 - (R_f)_k (R_m)_k \nu_{12} \nu_{21}} & \frac{(R_f)_k (R_m)_k \nu_{12} E_2}{1 - (R_f)_k (R_m)_k \nu_{12} \nu_{21}} & 0 \\ \frac{(R_f)_k (R_m)_k \nu_{12} E_2}{1 - (R_f)_k (R_m)_k \nu_{12} \nu_{21}} & \frac{(R_m)_k E_2}{1 - (R_f)_k (R_m)_k \nu_{12} \nu_{21}} & 0 \\ 0 & 0 & (R_m)_k G_{12} \end{bmatrix} = \mathbf{Q}_k^{dT} ,$$

where $E_1, E_2, \nu_{12}, \nu_{21}$, and G_{12} are the elastic constants of the lamina.

Damage Evolution:

In CODAM2, the evolution of damage mechanisms is expressed in terms of equivalent strain parameters. The equivalent strain function that governs the fiber stiffness reduction parameter is written in terms of the longitudinal normal strains by

$$\varepsilon_{f,k}^{eq} = \varepsilon_{11,k}, \quad k = 1, \dots, n$$

The equivalent strain function that governs the matrix stiffness reduction parameter is written in an interactive form in terms of the transverse and shear components of the local strain:

$$\varepsilon_{m,k}^{eq} = \text{sign}(\varepsilon_{22,k}) \sqrt{(\varepsilon_{22,k})^2 + \left(\frac{\gamma_{12,k}}{2}\right)^2}, \quad k = 1, \dots, n$$

The sign of the transverse normal strain plays a very important role in the initiation and growth of damage since it indicates the compressive or tensile nature of the transverse stress. Therefore, the equivalent strain for the matrix damage carries the sign of the transverse normal strain.

Evolution of the overall damage mechanism (anti-locking) is written in terms of the maximum principal strains:

$$\varepsilon_L^{eq} = \max[\text{prn}(\varepsilon)] .$$

Within the framework of non-local strain-softening formulations adopted here, all damage modes, be it intra-laminar (i.e. fiber and matrix damage) or overall sub-laminate

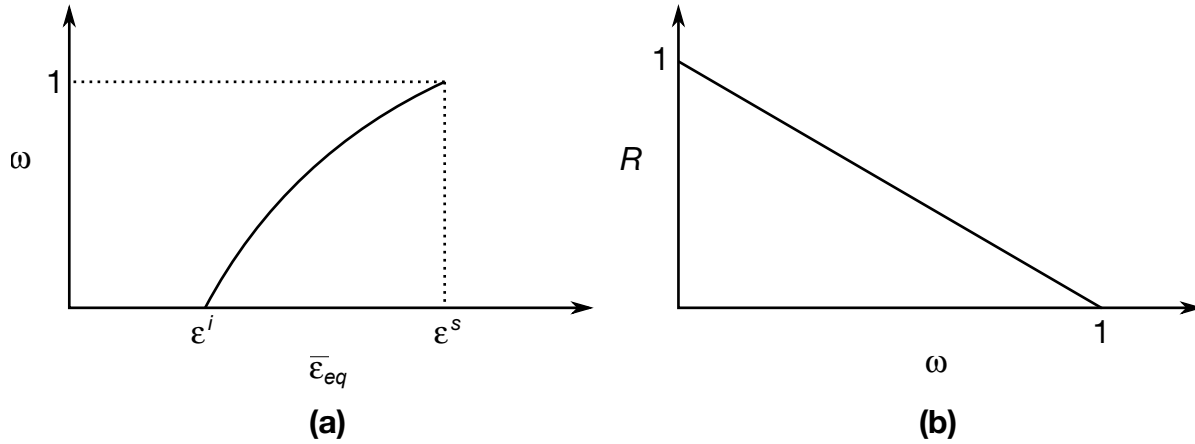

Figure M219-1. Illustrations of (a) damage parameter and (b) reduction parameter.

modes are considered to be a function of the non-local (averaged) equivalent strain defined as:

$$\bar{\epsilon}_\alpha^{eq} = \int_{\Omega_x} \epsilon_\alpha^{eq}(\mathbf{x}) w_\alpha(\mathbf{X} - \mathbf{x}) d\Omega ,$$

where the subscript α denotes the mode of damage: fiber ($\alpha = f$) and matrix ($\alpha = m$) damage in each layer, k , within the sub-laminate or associated with the overall sub-laminate, namely, locking ($\alpha = L$). Thus, for a given sub-laminate with n layers, ϵ_α^{eq} and $\bar{\epsilon}_\alpha^{eq}$ are vectors of size $2n + 1$. \mathbf{X} represents the position vector of the original point of interest and \mathbf{x} denotes the position vector of all other points (Gauss points) in the averaging zone denoted by Ω . In classical isotropic non-local averaging approach, this zone is taken to be spherical (or circular in 2D) with a radius of r (named R1 in the material input card). The parameter, r , which affects the size of the averaging zone, introduces a length scale into the model that is linked directly to the predicted size of the damage zone. Averaging is done with a bell-shaped weight function, w_α , evaluated by

$$w_\alpha = \left[1 - \left(\frac{d}{r} \right)^2 \right]^2 ,$$

where d is the distance from the integration point of interest to another integration point within the averaging zone.

The damage parameters, ω_α , are calculated as a function of the corresponding averaged equivalent strains. In CODAM2 the damage parameters are assumed to grow as a hyperbolic function of the damage potential (non-local equivalent strains) such that when used in conjunction with stiffness reduction factors that vary linearly with the damage parameters they result in a linear strain-softening response (or a bilinear stress-strain curve) for each mode of damage

$$\omega_\alpha = \frac{(|\bar{\epsilon}_\alpha^{eq}| - \epsilon_\alpha^i) \epsilon_\alpha^s}{(\epsilon_\alpha^s - \epsilon_\alpha^i) |\bar{\epsilon}_\alpha^{eq}|}, \quad |\bar{\epsilon}_\alpha^{eq}| - \epsilon_\alpha^i > 0$$

where superscripts i and s denote, respectively, the damage initiation and saturation values of the strain quantities to which they are assigned. The initiation and saturation parameters are defined in Cards 6 and 7. Damage is considered to be a monotonically increasing function of time, t , such that

$$\omega_\alpha = \max_{\tau < t}(\omega_\alpha^\tau) ,$$

where ω_α^t is the value of ω_α for the current time (load state), and ω_α^τ represents the state of damage at previous times $\tau \leq t$.

Damage is applied by scaling the layer stress by reduction parameters

$$R_\alpha = 1 - \omega_\alpha$$

where $\alpha = f$ and $\alpha = m$. The layer stresses are summed and then then scaled by reduction parameter

$$R_L = 1 - \omega_L .$$

Figures M219-1 (a) and (b) show the relationship between the damage and reduction parameters

If the parameter RESIDS > 0, damage in the layers is limited such that

$$\begin{aligned} R_f &= \max(\text{RESIDS}, 1 - \omega_f) \\ R_m &= \max(\text{RESIDS}, 1 - \omega_m) \end{aligned}$$

Element Erosion:

When ERODE > 0, an erosion criterion is checked at each integration point. Shell elements and thick shell elements will be deleted when the erosion criterion has been met at all integration points. Brick elements will be deleted when the erosion criterion is met at any of the integration points. For ERODE = 1, the erosion criterion is met when maximum principal strain exceeds either SLOCT × ERPAR1 for elements in tension, or SLOCC × ERPAR1 for elements in compression. Elements are in tension when the magnitude of the first principal strain is greater than the magnitude of the third principal strain and in compression when the third principal strain is larger. When R1 > 0, the ERODE = 1 criterion is checked using the non-local (averaged) principal strain. For ERODE = 2, the erosion criterion is met when the local (non-averaged) maximum principal strain exceeds ERPAR2. For ERODE = 3, both of these erosion criteria are checked. For visualization purposes, the ratio of the maximum principal strain over the limit is stored in the location of plastic strain which is written by default to the elout and d3plot files.

History Variables:

History variables for CODAM2 are enumerated in the following tables. To include them in the d3plot database, use NEIPH (solids) or NEIPS (shells) on *DATABASE_EXTENT_-

BINARY. For solid elements, add 4 to the variable numbers in the table because the first 6 history variables are reserved.

Damage parameters

VARIABLE #	DESCRIPTION
3	Overall (anti-locking) Damage.
4	Delamination Damage (for visualization only)
5	Fiber damage in the first layer
6	Matrix damage in the first layer
7	Fiber damage in the second layer
8	Matrix damage in the second layer
⋮	⋮
3 + 2 × NLAYER	Fiber damage in the last layer
4 + 2 × NLAYER	Matrix damage in the last layer

Equivalent Strains used to evaluate damage (averaged if R1 > 0)

VARIABLE #	DESCRIPTION
5 + 2 × NLAYER	ϵ_R^{eq}
6 + 2 × NLAYER	$\epsilon_{f,1}^{eq}$
7 + 2 × NLAYER	$\epsilon_{m,1}^{eq}$
8 + 2 × NLAYER	$\epsilon_{f,2}^{eq}$
9 + 2 × NLAYER	$\epsilon_{m,2}^{eq}$
⋮	⋮
4 + 4 × NLAYER	$\epsilon_{f,n}^{eq}$
5 + 4 × NLAYER	$\epsilon_{m,n}^{eq}$

Total Strain

VARIABLE #	DESCRIPTION
$6 + 4 \times \text{NLAYER}$	ε_x
$7 + 4 \times \text{NLAYER}$	ε_y
$8 + 4 \times \text{NLAYER}$	ε_z
$9 + 4 \times \text{NLAYER}$	γ_{xy}
$10 + 4 \times \text{NLAYER}$	γ_{yz}
$11 + 4 \times \text{NLAYER}$	γ_{zx}

***MAT_RIGID_DISCRETE**

This is Material Type 220, a rigid material for shells or solids. Unlike *MAT_020, a *MAT_220 part can be discretized into multiple disjoint pieces and have each piece behave as an independent rigid body. The inertia properties for the disjoint pieces are determined directly from the finite element discretization.

Nodes of a *MAT_220 part cannot be shared by any other rigid part. A *MAT_220 part may share nodes with deformable structural and solid elements.

This material option can be used to model granular material where the grains interact through an automatic single surface contact definition. Another possible use includes modeling bolts as rigid bodies where the bolts belong to the same part ID. This model eliminates the need to represent each rigid piece with a unique part ID.

Card	1	2	3	4	5	6	7	8
Variable	MID	RO	E	PR				
Type	A8	F	F	F				
Default	none	none	none	none				

VARIABLE**DESCRIPTION**

MID	Material identification. A unique number or label not exceeding 8 characters must be specified.
RO	Mass density.
E	Young's modulus.
PR	Poisson's ratio.

***MAT_ORTHOTROPIC_SIMPLIFIED_DAMAGE**

This is Material Type 221. It is an orthotropic material with optional simplified damage and optional failure for composites. This model is valid for 3D solid elements, for thick shell formulations 3, 5, and 7, and for SPH elements. The elastic behavior is the same as *MAT_022. Nine damage variables are defined such that damage is different in tension and compression. These damage variables are applicable to E_a , E_b , E_c , G_{ab} , G_{bc} and G_{ca} . In addition, nine failure criteria on strains are available. When failure occurs, elements are deleted (erosion). Failure depends on the number of integration points failed through the element. See the material description below.

Card Summary:

Card 1. This card is required.

MID	RO	EA	EB	EC	PRBA	PRCA	PRCB
-----	----	----	----	----	------	------	------

Card 2. This card is required.

GAB	GBC	GCA		AOPT	MACF		
-----	-----	-----	--	------	------	--	--

Card 3. This card is required.

XP	YP	ZP	A1	A2	A3		
----	----	----	----	----	----	--	--

Card 4. This card is required.

V1	V2	V3	D1	D2	D3	BETA	
----	----	----	----	----	----	------	--

Card 5. This card is required.

NERODE	NDAM	EPS1TF	EPS2TF	EPS3TF	EPS1CF	EPS2CF	EPS3CF
--------	------	--------	--------	--------	--------	--------	--------

Card 6. This card is required.

EPS12F	EPS23F	EPS13F	EPSD1T	EPSC1T	CDAM1T	EPSD2T	EPSC2T
--------	--------	--------	--------	--------	--------	--------	--------

Card 7. This card is required.

CDAM2T	EPSD3T	EPSC3T	CDAM3T	EPSD1C	EPSC1C	CDAM1C	EPSD2C
--------	--------	--------	--------	--------	--------	--------	--------

Card 8. This card is required.

EPSC2C	CDAM2C	EPSD3C	EPSC3C	CDAM3C	EPSD12	EPSC12	CDAM12
--------	--------	--------	--------	--------	--------	--------	--------

Card 9. This card is required.

EPD23	EPSC23	CDAM23	EPD31	EPSC31	CDAM31		
-------	--------	--------	-------	--------	--------	--	--

Data Card Definitions:

Card 1	1	2	3	4	5	6	7	8
Variable	MID	RO	EA	EB	EC	PRBA	PRCA	PRCB
Type	A	F	F	F	F	F	F	F
Default	none	none	none	none	none	none	none	none

VARIABLE

DESCRIPTION

MID	Material identification. A unique number or label must be specified (see *PART).
RO	Mass density
EA	E_a , Young's modulus in a -direction
EB	E_b , Young's modulus in b -direction
EC	E_c , Young's modulus in c -direction
PRBA	ν_{ba} , Poisson ratio
PRCA	ν_{ca} , Poisson ratio
PRCB	ν_{cb} , Poisson ratio

Card 2	1	2	3	4	5	6	7	8
Variable	GAB	GBC	GCA		AOPT	MACF		
Type	F	F	F		F	I		
Default	none	none	none		0.0	0		

VARIABLE	DESCRIPTION
GAB	G_{ab} , Shear modulus
GBC	G_{bc} , Shear modulu
GCA	G_{ca} , Shear modulus
AOPT	<p>Material axes option (see MAT_OPTIONTROPIC_ELASTIC, particularly the Material Directions section, for details):</p> <p>EQ.0.0: Locally orthotropic with material axes determined by element nodes 1, 2, and 4, as with *DEFINE_COORDINATE_NODES.</p> <p>EQ.1.0: Locally orthotropic with material axes determined by a point, P, in space and the global location of the element center; this is the a-direction. This option is for solid elements only.</p> <p>EQ.2.0: Globally orthotropic with material axes determined by vectors defined below, as with *DEFINE_COORDINATE_VECTOR</p> <p>EQ.3.0: Locally orthotropic material axes determined by a vector \mathbf{v} and the normal vector to the plane of the element. The plane of a solid element is the midsurface between the inner surface and outer surface defined by the first four nodes and the last four nodes of the connectivity of the element, respectively. Thus, for solid elements, AOPT = 3 is only available for hexahedrons. a is determined by taking the cross product of \mathbf{v} with the normal vector, b is determined by taking the cross product of the normal vector with a, and c is the normal vector. Then a and b are rotated about c by an angle BETA. BETA may be set in the keyword input for the element or in the input for this keyword. Note that for solids, the material axes may be switched depending on the choice of MACF. The switch may occur before or after applying BETA depending on the value of MACF.</p> <p>EQ.4.0: Locally orthotropic in a cylindrical coordinate system with the material axes determined by a vector \mathbf{v}, and an originating point, P, which define the centerline axis. This option is for solid elements only.</p> <p>LT.0.0: The absolute value of AOPT is a coordinate system ID number (CID on *DEFINE_COORDINATE_OPTION).</p>

VARIABLE	DESCRIPTION
----------	-------------

MACF Material axes change flag for solid elements:

EQ.-4: Switch material axes *b* and *c* before BETA rotation
 EQ.-3: Switch material axes *a* and *c* before BETA rotation
 EQ.-2: Switch material axes *a* and *b* before BETA rotation
 EQ.1: No change, default
 EQ.2: Switch material axes *a* and *b* after BETA rotation
 EQ.3: Switch material axes *a* and *c* after BETA rotation
 EQ.4: Switch material axes *b* and *c* after BETA rotation

Figure M2-2 indicates when LS-DYNA applies MACF during the process to obtain the final material axes. If BETA on *ELEMENT_SOLID_{OPTION} is defined, then that BETA is used for the rotation for all AOPT options. Otherwise, if AOPT = 3, the BETA input on Card 4 rotates the axes. For all other values of AOPT, the material axes will be switched as specified by MACF, but no BETA rotation will be performed.

Card 3	1	2	3	4	5	6	7	8
Variable	XP	YP	ZP	A1	A2	A3		
Type	F	F	F	F	F	F		
Default	0.0	0.0	0.0	0.0	0.0	0.0		

VARIABLE	DESCRIPTION
----------	-------------

XP, YP, ZP Coordinates of point *p* for AOPT = 1 and 4

A1, A2, A3 Components of vector **a** for AOPT = 2

MAT_221**MAT_ORTHOTROPIC_SIMPLIFIED_DAMAGE**

Card 4	1	2	3	4	5	6	7	8
Variable	V1	V2	V3	D1	D2	D3	BETA	
Type	F	F	F	F	F	F	F	
Default	0.0	0.0	0.0	0.0	0.0	0.0	0.0	

VARIABLE**DESCRIPTION**

V1, V2, V3

Components of vector \mathbf{v} for AOPT = 3 and 4

D1, D2, D3

Components of vector \mathbf{d} for AOPT = 2

BETA

Material angle in degrees for AOPT = 3. It may be overridden on the element card, see *ELEMENT_SOLID_ORTHO.

Card 5	1	2	3	4	5	6	7	8
Variable	NERODE	NDAM	EPS1TF	EPS2TF	EPS3TF	EPS1CF	EPS2CF	EPS3CF
Type	I	I	F	F	F	F	F	F
Default	0	0	10^{20}	10^{20}	10^{20}	-10^{20}	-10^{20}	-10^{20}

VARIABLE**DESCRIPTION**

NERODE

Element erosion flag. For multi-integration point elements, each of the failure strains mentioned below for NERODE ≥ 2 need only occur in one integration point to trigger element erosion. For NERODE values 6 to 11, which require more than one failure strain be reached, those failure strains need not occur in the same integration point.

EQ.0: No erosion (default)

EQ.1: Erosion occurs when one failure strain is reached in all integration points.

EQ.2: Erosion occurs when one failure strain is reached.

EQ.3: Erosion occurs when a tension or compression failure strain in the a -direction is reached.

VARIABLE	DESCRIPTION
	EQ.4: Erosion occurs when as a tension or compression failure strain in the b -direction is reached.
	EQ.5: Erosion occurs when a tension or compression failure strain in the c -direction is reached.
	EQ.6: Erosion occurs when tension or compression failure strain in both the a - and b -directions are reached.
	EQ.7: Erosion occurs when tension or compression failure strain in both the b - and c -directions are reached.
	EQ.8: Erosion occurs when tension or compression failure strain in both the a - and c -directions are reached.
	EQ.9: Erosion occurs when tension or compression failure strain in all 3 directions are reached.
	EQ.10: Erosion occurs when tension or compression failure strain in both the a - and b -directions is reached and either of the out-of-plane failure shear strains (bc or ac) is reached.
	EQ.11: Erosion occurs when tension failure strain in either the a - or b -directions is reached and either of the out-of-plane failure shear strains (bc or ac) is reached.
NDAM	Damage flag: EQ.0: No damage (default) EQ.1: Damage in tension only (null for compression) EQ.2: Damage in tension and compression
EPS1TF	Failure strain in tension along the a -direction
EPS2TF	Failure strain in tension along the b -direction
EPS3TF	Failure strain in tension along the c -direction
EPS1CF	Failure strain in compression along the a -direction
EPS2CF	Failure strain in compression along the b -direction
EPS3CF	Failure strain in compression along the c -direction

Card 6	1	2	3	4	5	6	7	8
Variable	EPS12F	EPS23F	EPS13F	EPD1T	EPSC1T	CDAM1T	EPD2T	EPSC2T
Type	F	F	F	F	F	F	F	F
Default	10 ²⁰	10 ²⁰	10 ²⁰	0.	0.	0.	0.	0.

VARIABLE**DESCRIPTION**

EPS12F	Failure shear strain in the <i>ab</i> -plane
EPS23F	Failure shear strain in the <i>bc</i> -plane
EPS13F	Failure shear strain in the <i>ac</i> -plane
EPD1T	Damage threshold in tension along the <i>a</i> -direction, ϵ_{1t}^s
EPSC1T	Critical damage threshold in tension along the <i>a</i> -direction, ϵ_{1t}^c
CDAM1T	Critical damage in tension along the <i>a</i> -direction, D_{1t}^c
EPD2T	Damage threshold in tension along the <i>b</i> -direction, ϵ_{2t}^s
EPSC2T	Critical damage threshold in tension along the <i>b</i> -direction, ϵ_{2t}^c

Card 7	1	2	3	4	5	6	7	8
Variable	CDAM2T	EPD3T	EPSC3T	CDAM3T	EPD1C	EPSC1C	CDAM1C	EPD2C
Type	I	I	F	F	F	F	F	F
Default	0.	0.	0.	0.	0.	0.	0.	0.

VARIABLE**DESCRIPTION**

CDAM2T	Critical damage in tension along the <i>b</i> -direction, D_{2t}^c
EPD3T	Damage threshold in tension along the <i>c</i> -direction, ϵ_{3t}^s
EPSC3T	Critical damage threshold in tension along the <i>c</i> -direction, ϵ_{3t}^c

VARIABLE	DESCRIPTION
CDAM3T	Critical damage in tension along the c -direction, D_{3t}^c
EPD1C	Damage threshold in compression along the a -direction, ε_{1c}^s
EPSC1C	Critical damage threshold in compression along the a -direction, ε_{1c}^c
CDAM1C	Critical damage in compression along the a -direction, D_{1c}^c
EPD2C	Damage threshold in compression along the b -direction, ε_{2c}^s

Card 8	1	2	3	4	5	6	7	8
Variable	EPSC2C	CDAM2C	EPD3C	EPSC3C	CDAM3C	EPD12	EPSC12	CDAM12
Type	F	F	F	F	F	F	F	F
Default	0.	0.	0.	0.	0.	0.	0.	0.

VARIABLE	DESCRIPTION
EPSC2C	Critical damage threshold in compression along the b -direction, ε_{2c}^c
CDAM2C	Critical damage in compression along the b -direction, D_{2c}^c
EPD3C	Damage threshold in compression along the c -direction, ε_{3c}^s
EPSC3C	Critical damage threshold in compression along the c -direction, ε_{3c}^c
CDAM3C	Critical damage in compression along the c -direction, D_{3c}^c
EPD12	Damage threshold for shear in the ab -plane, ε_{12}^s
EPSC12	Critical damage threshold for shear in the ab -plane, ε_{12}^c
CDAM12	Critical damage for shear in the ab -plane, D_{12}^c

Card 9	1	2	3	4	5	6	7	8
Variable	EPD23	EPSC23	CDAM23	EPD31	EPSC31	CDAM31		
Type	F	F	F	F	F	F		
Default	0.	0.	0.	0.	0.	0.		

VARIABLE**DESCRIPTION**

EPD23	Damage threshold for shear in the bc -plane, ε_{23}^s
EPSC23	Critical damage threshold for shear in the bc -plane, ε_{23}^c
CDAM23	Critical damage for shear in the bc -plane, D_{23}^c
EPD31	Damage threshold for shear in the ac -plane, ε_{31}^s
EPSC31	Critical damage threshold for shear in the ac -plane, ε_{31}^c
CDAM31	Critical damage for shear in the ac -plane, D_{31}^c

Remarks:

If $\varepsilon_k^c < \varepsilon_k^s$, no damage is considered. Failure occurs only when failure strain is reached.

Failure can occur along the 3 orthotropic directions, in tension, in compression and for shear behavior. Nine failure strains drive the failure. When failure occurs, elements are deleted (erosion). Under the control of the NERODE flag, failure may occur either when only one integration point has failed, when several integration points have failed or when all integrations points have failed.

Damage applies to the 3 Young's moduli and the 3 shear moduli. Damage is different for tension and compression. Nine damage variables are used: $d_{1t}, d_{2t}, d_{3t}, d_{1c}, d_{2c}, d_{3c}, d_{12}, d_{23}, d_{13}$. The damaged flexibility matrix is:

$$-S^{\text{dam}} = \begin{pmatrix} \frac{1}{E_a(1-d_{1[t,c]})} & \frac{-v_{ba}}{E_b} & \frac{-v_{ca}}{E_c} & 0 & 0 & 0 \\ \frac{-v_{ba}}{E_b} & \frac{1}{E_b(1-d_{2[t,c]})} & \frac{-v_{cb}}{E_c} & 0 & 0 & 0 \\ \frac{-v_{ca}}{E_c} & \frac{-v_{cb}}{E_c} & \frac{1}{E_c(1-d_{3[t,c]})} & 0 & 0 & 0 \\ 0 & 0 & 0 & \frac{1}{G_{ab}(1-d_{12})} & 0 & 0 \\ 0 & 0 & 0 & 0 & \frac{1}{G_{bc}(1-d_{23})} & 0 \\ 0 & 0 & 0 & 0 & 0 & \frac{1}{G_{ca}(1-d_{31})} \end{pmatrix}$$

The nine damage variables are calculated as follows:

$$d_k = \max \left(d_k, D_k^c \left\langle \frac{\epsilon_k - \epsilon_k^s}{\epsilon_k^c - \epsilon_k^s} \right\rangle_+ \right)$$

with $k = 1t, 2t, 3t, 1c, 2c, 3c, 12, 23, 31$.

$$\langle \cdot \rangle_+ \text{ is the positive part: } \langle x \rangle_+ = \begin{cases} x & \text{if } x > 0 \\ 0 & \text{if } x < 0 \end{cases}$$

Damage in compression may be deactivated with the NDAM flag. In this case, damage in compression is null, and only damage in tension and for shear behavior are taken into account.

The nine damage variables may be post-processed through additional variables. The number of additional variables for solids written to the d3plot and d3thdt databases is input by the optional *DATABASE_EXTENT_BINARY card as variable NEIPH. These additional variables are tabulated below:

History Variable	Description	Value	LS-PrePost History Variable
d_{1t}	damage in traction along a	0 - no damage $0 < d_k < D_k^c$ - damage	plastic strain
d_{2t}	damage in traction along b		1
d_{3t}	damage in traction along c		2
d_{1c}	damage in compression along a		3
d_{2c}	damage in compression along b		4
d_{3c}	damage in compression along c		5
d_{12}	shear damage in ab -plane		6
d_{23}	shear damage in bc -plane		7
d_{13}	shear damage in ac -plane		8

The first damage variable is stored in the place of effective plastic strain. The eight other damage variables may be plotted in LS-PrePost as element history variables.

***MAT_TABULATED_JOHNSON_COOK_{OPTION}**

This is Material Type 224. With this type, you can model an elasto-viscoplastic material with arbitrary stress versus strain curve(s) and arbitrary strain rate dependency. Plastic heating causes temperature to increase adiabatically and material softening. Optional plastic failure strain can be a function of triaxiality, strain rate, temperature and/or element size. Please take careful note of the sign convention for triaxiality as illustrated in [Figure M224-1](#). This material model resembles the original Johnson-Cook material (see *MAT_015) but with the possibility of general tabulated input parameters.

An equation of state (*EOS) is optional for solid elements, tshell formulations 3 and 5, and 2D continuum elements. It is invoked by setting EOSID to a nonzero value in *PART. If an equation of state is used, only the deviatoric stresses are calculated by the material model, and the pressure is calculated by the equation of state.

Available options include:

<BLANK>

LOG_INTERPOLATION

With LOG_INTERPOLATION, the strain rate effect in table LCK1 is interpolated with logarithmic interpolation.

Card 1	1	2	3	4	5	6	7	8
Variable	MID	RO	E	PR	CP	TR	BETA	NUMINT
Type	A	F	F	F	F	F	F	F
Default	none	none	none	none	none	0.0	1.0	1.0

Card 2	1	2	3	4	5	6	7	8
Variable	LCK1	LCKT	LCF	LCG	LCH	LCI	BFLG	
Type	I	I	I	I	I	I	I	
Default	0	0	0	0	0	0	0	

This card is optional.

Card 3	1	2	3	4	5	6	7	8
Variable	FAILOPT	NUMAVG	NCYFAIL	ERODE	LCPS			
Type	I	I	I	I	I			
Default	0	1	1	0	0			

VARIABLE**DESCRIPTION**

MID	Material identification. A unique number or label must be specified (see *PART).
RO	Mass density
E	Young's modulus: GT.0.0: Constant value is used. LT.0.0: -E gives curve ID for temperature dependence.
PR	Poisson's ratio
CP	Specific heat (superseded by heat capacity in *MAT_THERMAL_OPTION if a coupled thermal/structural analysis)
TR	Room temperature
BETA	Fraction of plastic work converted into heat (supersedes FWORK in *CONTROL_THERMAL_SOLVER if a coupled thermal/structural analysis): EQ.0.0: Defaults to 1.0. GT.0.0: Constant value is used. LT.0.0: -BETA gives a curve ID for strain rate dependence, a table ID for strain rate and temperature dependence, a 3-dimensional table ID for temperature (TABLE_3D), strain rate (TABLE) and plastic strain (CURVE) dependence, or a 4-dimensional table ID for triaxiality (TABLE_4D), temperature (TABLE_3D), strain rate (TABLE) and plastic strain (CURVE) dependence. Please see the description of BFLG below for an alternative interpretation of TABLE_3D arguments.

VARIABLE	DESCRIPTION
NUMINT	<p>GT.0.0: Number of integration points which must fail before the element is deleted. Available for shells and solids.</p> <p>LT.0.0: -NUMINT is percentage of integration points/layers which must fail before shell element fails. For fully integrated shells, a layer fails if one integration point fails. Then, the given percentage of layers must fail before the element fails. Only available for shells.</p> <p>EQ.-200: Turns off erosion for shells and solids. Not recommended unless used in conjunction with *CONSTRAINED_TIED_NODES_FAILURE.</p>
LCK1	<p>Load curve ID, table ID, or 3D table ID. The load curve gives effective stress as a function of effective plastic strain. The table gives for each plastic strain rate value a load curve ID specifying the (isothermal) effective stress as a function of effective plastic strain for that rate. As in *MAT_024, natural logarithmic strain rates can be used by setting the <i>first</i> strain rate to a negative value. See Remark 1.</p> <p>If referring to a three-dimensional table ID, the yield stress can be a function of temperature (TABLE_3D), plastic strain rate (TABLE), and plastic strain (CURVE). LCKT is ignored in that case.</p>
LCKT	<p>Table ID defining for each temperature value a load curve ID giving the (quasi-static) effective stress versus effective plastic strain for that temperature. See Remark 1.</p>
LCF	<p>Load curve ID or table ID. The load curve ID defines plastic failure strain (or scale factor – see Remark 2) as a function of triaxiality. The table ID defines for each Lode parameter a load curve ID giving the plastic failure strain versus triaxiality for that Lode parameter. See Remark 2 for a description of the combination of LCF, LCG, LCH, and LCI.</p>
LCG	<p>Load curve ID defining plastic failure strain (or scale factor – see Remark 2) as a function of plastic strain rate (<i>The curve should not extrapolate to zero or failure may occur at low strain</i>). If the <i>first</i> abscissa value in the curve corresponds to a negative strain rate, LS-DYNA assumes that the natural logarithm of the strain rate value is used for all abscissa values. See Remark 2 for a description of the combination of LCF, LCG, LCH, and LCI.</p>

VARIABLE	DESCRIPTION
LCH	Load curve ID defining plastic failure strain (or scale factor – see Remark 2) as a function of temperature. See Remark 2 for a description of the combination of LCF, LCG, LCH, and LCI.
LCI	Load curve ID, table ID, or table_3D ID. The load curve ID defines plastic failure strain (or scale factor – see Remark 2) as a function of element size. The table ID defines for each triaxiality a load curve ID giving the plastic failure strain versus element size for that triaxiality. If referring to a three-dimensional table ID, plastic failure strain can be a function of Lode parameter (TABLE_3D), triaxiality (TABLE), and element size (CURVE). See Remark 2 for a description of the combination of LCF, LCG, LCH, and LCI.
BFLG	Flag for treatment of case $BETA < 0$ with TABLE_3D (available for solid elements only): EQ.0: Dissipation factor β is a function of temperature, strain rate, and plastic strain (as already described above). EQ.1: Dissipation factor β is a function of maximum shear strain (TABLE_3D), strain rate (TABLE), and element size (CURVE).
FAILOPT	Flag for additional failure criterion F_2 (see Remark 3). EQ.0: Off (default) EQ.1: On
NUMAVG	Number of time steps for running average of plastic failure strain in the additional failure criterion. Default is 1 (no averaging). See Remark 3 .
NCYFAIL	Number of time steps that the additional failure criterion must be met before element deletion. Default is 1. See Remark 3 .
ERODE	Erosion flag (only for solid elements): EQ.0: Default, element erosion is allowed. EQ.1: Element does not erode; deviatoric stresses set to zero when element fails.

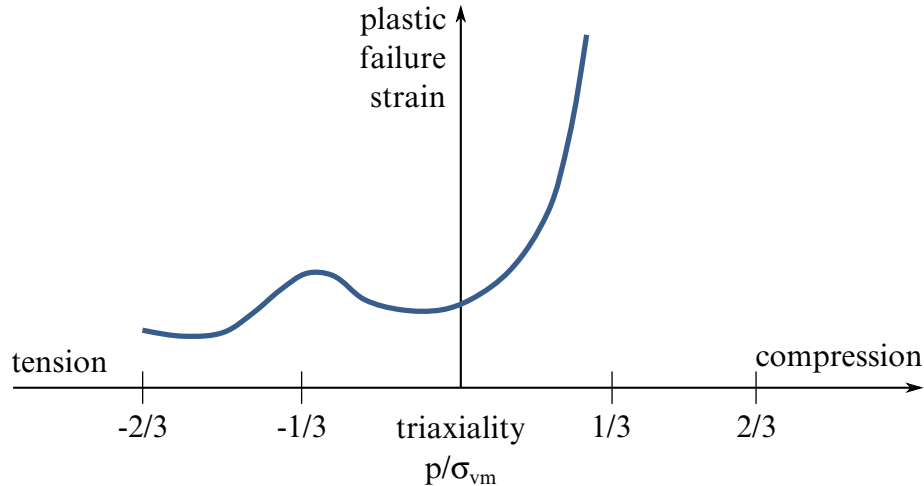

Figure M224-1. Typical failure curve for metal sheet, modeled with shell elements.

VARIABLE	DESCRIPTION
LCPS	Table ID with first principal stress limit as a function of plastic strain (curves) and plastic strain rate (table). This option is for post-processing purposes only and gives an indication of areas in the structure where failure is likely to occur. History variable #17 shows a value of 1.0 for integration points that exceeded the limit, else a value of 0.0.

Remarks:

1. **Flow Stress.** The flow stress σ_y is expressed as a function of plastic strain ϵ_p , plastic strain rate $\dot{\epsilon}_p$ and temperature T through the following formula (using load curves/tables LCK1 and LCKT):

$$s_y = k_1(\epsilon_p, \dot{\epsilon}_p) \frac{k_t(\epsilon_p, T)}{k_t(\epsilon_p, T_R)}$$

Note that T_R is a material parameter and should correspond to the temperature used when performing the room temperature tensile tests. If simulations are to be performed with an initial temperature T_I deviating from T_R , then this temperature should be set using *INITIAL_STRESS_SOLID/SHELL by setting history variable #14 for solid elements or history variable #10 for shell elements.

2. **Plastic Failure Strain.** Optional plastic failure strain is defined as a function of triaxiality p/σ_{vm} , Lode parameter, plastic strain rate $\dot{\epsilon}_p$, temperature T and initial element size l_c (square root of element area for shells and volume over maximum area for solids) by

$$\varepsilon_{pf} = f\left(\frac{p}{\sigma_{vm}}, \frac{27J_3}{2\sigma_{vm}^3}\right) g(\dot{\varepsilon}_p) h(T) i\left(l_c, \frac{p}{\sigma_{vm}}\right)$$

using load curves/tables LCF, LCG, LCH and LCI. If more than one of these four variables LCF, LCG, LCH and LCI are defined, be aware that the net plastic failure strain is essentially the product of multiple functions as shown in the above equation. This means that one and only one of the variables LCF, LCG, LCH, and LCI can point to curve(s) that have plastic strain along the curve ordinate. The remaining nonzero variable(s) LCF, LCG, LCH, and LCI should point to curve(s) that have a unitless scaling factor along the curve ordinate.

A typical failure curve LCF for metal sheet, modeled with shell elements is shown in [Figure M224-1](#). Triaxiality should be monotonically increasing in this curve. A reasonable range for triaxiality is $-2/3$ to $2/3$ if shell elements are used (plane stress). For 3-dimensional stress states (solid elements), the possible range of triaxiality goes from $-\infty$ to $+\infty$, but to get a good resolution in the internal load curve discretization (depending on parameter LCINT of *CONTROL_-SOLUTION) you should define lower limits, e.g. -1 to 1 if LCINT = 100 (default).

- 3. Failure Criterion.** The default failure criterion of this material model depends on plastic strain evolution $\dot{\varepsilon}_p$ and on plastic failure strain ε_{pf} and is obtained by accumulation over time:

$$F = \int \frac{\dot{\varepsilon}_p}{\varepsilon_{pf}} dt$$

where element erosion takes place when $F \geq 1$. This accumulation provides load-path dependent treatment of failure. The value of F is stored as history variable #8 for shells and #12 for solids.

An additional, load-path independent, failure criterion can be invoked by setting FAILOPT = 1, where the current state of plastic strain is used:

$$F_2 = \frac{\varepsilon_p}{\varepsilon_{pf}}$$

Two additional parameters can be used as countermeasures against stress oscillations for this failure criterion. With NUMAVG active, plastic failure strain is averaged over NUMAVG time steps for the F_2 criterion. The value of F_2 , taking into account any averaging per NUMAVG, is stored as history variable #14 for shells and #16 for solids. NUMAVG cannot exceed 30. NCYFAIL defines the number of time steps that $F_2 \geq 1$ must be met before element deletion takes place. The number of time steps that $F_2 \geq 1$ is stored as history variable #15 for shells and #19 for solids.

- 4. Change in Temperature.** Temperature increase is caused by plastic work

$$T = T_R + \frac{\beta}{C_p \rho} \int \sigma_y \dot{\epsilon}_p dt$$

with room temperature T_R , dissipation factor β , specific heat C_p , and density ρ . If a coupled thermal/structural analysis is performed, temperatures from the thermal solver are used. In that case, the plastic work that is to be converted to heat is transferred to the thermal solver as additional volumetric heat source. If no dissipation factor is defined, the value of FWORK in *CONTROL_THERMAL_SOLVER is used.

5. **Failure when used with *CONSTRAINED_TIED_NODES_WITH_FAILURE.** For *CONSTRAINED_TIED_NODES_WITH_FAILURE, the failure is based on the damage instead to the plastic strain.
6. **History Variables.** History variables may be post-processed through additional variables. The number of additional variables for shells/solids written to the d3plot and d3thdt databases is input by the optional *DATABASE_EXTENT_BINARY card as variable NEIPS/NEIPH. Specifically, when used with shell element type 14 or 15, history variable output will be as a solid element, not a shell element. The relevant additional variables of this material model are tabulated below:

History Variable #	Description for Shell Elements	History Variable #	Description for Solid Elements
1	Plastic strain rate	5	Plastic strain rate
7	Plastic work	8	Plastic failure strain
8	Ratio of plastic strain to plastic failure strain	9	Triaxiality
9	Element size	10	Lode parameter
10	Temperature	11	Plastic work
11	Plastic failure strain	12	Ratio of plastic strain to plastic failure strain
12	Triaxiality	13	Element size
16	Fraction of plastic work to heat	14	Temperature
17	LCPS: critical value	17	LCPS: critical value

History Variable #	Description for Shell Elements	History Variable #	Description for Solid Elements
		18	Fraction of plastic work to heat

*MAT_TABULATED_JOHNSON_COOK_GYS_{OPTION}

This is Material Type 224_GYS. This is an isotropic elastic plastic material law with a J3 dependent yield surface. This material considers tensile/compressive asymmetry in the material response, which is important for HCP metals like Titanium. The model is available for solid elements.

Available options include:

<BLANK>

LOG_INTERPOLATION

With LOG_INTERPOLATION, the strain rate effect in table LCK1 (Card 2) is interpolated with logarithmic interpolation.

Card 1	1	2	3	4	5	6	7	8
Variable	MID	RO	E	PR	CP	TR	BETA	NUMINT
Type	A	F	F	F	F	F	F	F
Default	none	none	none	none	none	0.0	1.0	1.0

Card 2	1	2	3	4	5	6	7	8
Variable	LCK1	LCKT	LCF	LCG	LCH	LCI		
Type	I	I	I	I	I	I		
Default	0	0	0	0	0	0		

Card 3	1	2	3	4	5	6	7	8
Variable	LCCR	LCCT	LCSR	LCST	IFLAG	SFIEPM	NITER	
Type	I	I	I	I	I	F	I	
Default	0	0	0	0	0	1	100	

VARIABLE	DESCRIPTION
MID	Material identification. A unique number or label must be specified (see *PART).
RO	Mass density
E	Young's modulus: GT.0.0: Constant value is used. LT.0.0: Temperature dependent Young's modulus given by load curve ID = -E
PR	Poisson's ratio
CP	Specific heat
TR	Room temperature
BETA	Fraction of plastic work converted into heat (superseded by FWORK in *CONTROL_THERMAL_SOLVER if a coupled thermal/structural analysis): GT.0.0: Constant value is used. LT.0.0: -BETA gives a load curve ID for strain rate dependence, a table ID for strain rate and temperature dependence, a 3-dimensional table ID for temperature (TABLE_3D), strain rate (TABLE) and plastic strain (CURVE) dependence, or a 4-dimensional table ID for triaxiality (TABLE_4D), temperature (TABLE_3D), strain rate (TABLE) and plastic strain (CURVE) dependence.
NUMINT	Number of integration points which must fail before the element is deleted. EQ.-200: Turns off erosion for solids. Not recommended unless used in conjunction with *CONSTRAINED_TIED_NODES_FAILURE.
LCK1	Table ID defining for each plastic strain rate value a load curve ID giving the (isothermal) effective stress as a function of effective plastic strain for that rate.
LCKT	Table ID defining for each temperature value a load curve ID giving the (quasi-static) effective stress as a function of effective plastic strain for that temperature.

VARIABLE	DESCRIPTION
LCF	Load curve ID or table ID. The load curve specifies plastic failure strain as a function of triaxiality. The table specifies for each Lode parameter a load curve ID giving the plastic failure strain versus triaxiality for that Lode parameter. (Table option not yet generally supported).
LCG	Load curve ID for specifying plastic failure strain as a function of plastic strain rate.
LCH	Load curve ID for specifying plastic failure strain as a function of temperature
LCI	Load curve ID or table ID. The load curve ID defines plastic failure strain as a function of element size. The table ID defines for each triaxiality a load curve ID giving the plastic failure strain versus element size for that triaxiality.
LCCR	Table ID. The curves in this table define compressive yield stress as a function of plastic strain or effective plastic strain (see IFLAG). The table ID defines for each plastic strain rate value or effective plastic strain rate value a load curve ID giving the (isothermal) compressive yield stress as a function of plastic strain or effective plastic strain for that rate.
LCCT	Table ID defining for each temperature value a load curve ID giving the (quasi-static) compressive yield stress as a function of strain for that temperature. The curves in this table define compressive yield stress as a function of plastic strain or effective plastic strain (see IFLAG).
LCSR	Table ID. The load curves define shear yield stress in function of plastic strain or effective plastic strain (see IFLAG). The table ID defines for each plastic strain rate value or effective plastic strain rate value a load curve ID giving the (isothermal) shear yield stress as a function of plastic strain or effective plastic strain for that rate.
LCST	Table ID defining for each temperature value a load curve ID giving the (quasi-static) shear yield stress as a function of strain for that temperature. The load curves define shear yield stress as a function of plastic strain or effective plastic strain (see IFLAG).

VARIABLE	DESCRIPTION
IFLAG	Flag to specify abscissa for LCCR, LCCT, LCSR, LCST: EQ.0: Compressive and shear yields are given as functions of plastic strain as defined in Remark 1 (default). EQ.1: Compressive and shear yields are given as functions of effective plastic strain.
SFIEPM	Scale factor on the initial estimate of the plastic multiplier
NITER	Number of secant iterations to be performed

Remarks:

- IFLAG.** If IFLAG = 0, the compressive and shear curves are defined as follows:

$$\sigma_c(\epsilon_{pc}, \dot{\epsilon}_{pc}), \quad \epsilon_{pc} = \epsilon_c - \frac{\sigma_c}{E}, \quad \dot{\epsilon}_{pc} = \frac{\partial \epsilon_{pc}}{\partial t}$$

$$\sigma_s(\gamma_{ps}, \dot{\gamma}_{ps}), \quad \gamma_{ps} = \gamma_s - \frac{\sigma_s}{G}, \quad \dot{\gamma}_{ps} = \frac{\partial \gamma_{ps}}{\partial t}$$

Two history variables (#16 plastic strain in compression and #17 plastic strain in shear) are stored in addition to those history variables already stored for *MAT_224.

If IFLAG = 1, the compressive and shear curves are defined as follows:

$$\sigma_c(\dot{\lambda}, \lambda), \quad \sigma_s(\dot{\lambda}, \lambda), \quad \dot{W}_p = \sigma_{\text{eff}} \dot{\lambda}$$

- History variables may be post-processed through additional variables. The number of additional variables for solids written to the d3plot and d3thdt databases is input through NEIPH on optional *DATABASE_EXTENT_BINARY. The relevant additional history variables for this material model are listed below:

History Variable #	Description
5	Plastic strain rate
8	Plastic failure strain
9	Triaxiality
10	Lode parameter

History Variable #	Description
11	Plastic work
12	Damage
13	Element size
14	Temperature
16	Plastic strain in compression
17	Plastic strain in shear

***MAT_VISCOPLASTIC_MIXED_HARDENING**

This is Material Type 225. An elasto-viscoplastic material with an arbitrary stress as a function of strain curve and arbitrary strain rate dependency can be defined. Kinematic, isotropic, or a combination of kinematic and isotropic hardening can be specified. Also, failure based on plastic strain can be defined.

Card 1	1	2	3	4	5	6	7	8
Variable	MID	RO	E	PR	LCSS	BETA		
Type	A8	F	F	F	I	F		
Default	none	none	none	none	none	0.0		

Card 2	1	2	3	4	5	6	7	8
Variable	FAIL							
Type	F							
Default	10 ²⁰							

VARIABLE**DESCRIPTION**

MID	Material identification. A unique number or label not exceeding 8 characters must be specified.
RO	Mass density
E	Young's modulus
PR	Poisson's ratio

VARIABLE	DESCRIPTION
LCSS	<p>Load curve ID or Table ID. Load curve ID defining effective stress as a function of effective plastic strain The table ID defines for each strain rate value a load curve ID giving the stress as a function of effective plastic strain for that rate, See Figure M24-1. The stress as a function of effective plastic strain curve for the lowest value of strain rate is used if the strain rate falls below the minimum value. Likewise, the stress as a function of effective plastic strain curve for the highest value of strain rate is used if the strain rate exceeds the maximum value. NOTE: The strain rate values defined in the table may be given as the natural logarithm of the strain rate. If the <i>first</i> stress-strain curve in the table corresponds to a negative strain rate, LS-DYNA assumes that the natural logarithm of the strain rate value is used. Since the tables are internally discretized to equally space the points, natural logarithms are necessary, for example, if the curves correspond to rates from 10^{-4} to 10^4.</p>
BETA	<p>Hardening parameter, $0.0 < \text{BETA} < 1.0$:</p> <p>EQ.0.0: pure kinematic hardening</p> <p>EQ.1.0: pure isotropic hardening</p> <p>$0.0 < \text{BETA} < 1.0$: mixed hardening</p>
FAIL	<p>Failure flag:</p> <p>LT.0.0: user defined failure subroutine is called to determine failure</p> <p>EQ.0.0: failure is not considered. This option is recommended if failure is not of interest since many calculations will be saved.</p> <p>GT.0.0: Plastic strain to failure. When the plastic strain reaches this value, the element is deleted from the calculation.</p>

***MAT_KINEMATIC_HARDENING_BARLAT89_{OPTION}**

This is Material Type 226. This model combines the Yoshida & Uemori non-linear kinematic hardening rule (*MAT_125) with the 3-parameter material model of Barlat and Lian [1989] (*MAT_36) to model metal sheets under cyclic plasticity loading with anisotropy in plane stress condition. Lankford parameters are used for the definition of the anisotropy. Yoshida's theory describes the hardening rule with a "two surfaces" method: the yield surface and the bounding surface. In the forming process, the yield surface does not change in size, but its center moves with deformation; the bounding surface changes both in size and location.

Available options include:

<BLANK>

NLP

The NLP option estimates necking failure using the Formability Index (F.I.), which accounts for the non-linear strain paths seen in metal forming applications (see [Remark 4](#)). When using this option, specify IFLD in Card 3. Since the NLP option also works with a linear strain path, it is recommended to be used as the default failure criterion in metal forming. The NLP option is also available for *MAT_036, *MAT_037, and *MAT_226.

Card Summary:

Card 1. This card is required.

MID	RO	E	PR	M	R00	R45	R90
-----	----	---	----	---	-----	-----	-----

Card 2. This card is required.

CB	Y	SC	K	RSAT	SB	H	HLCID
----	---	----	---	------	----	---	-------

Card 3. This card is required.

AOPT	IOPT	C1	C2	IFLD	EA	COE	
------	------	----	----	------	----	-----	--

Card 4. This card is required.

			A1	A2	A3		
--	--	--	----	----	----	--	--

Card 5. This card is required.

V1	V2	V3	D1	D2	D3	BETA	
----	----	----	----	----	----	------	--

Data Card Definitions:

Card 1	1	2	3	4	5	6	7	8
Variable	MID	RO	E	PR	M	R00	R45	R90
Type	A	F	F	F	F	F	F	F
Default	none	0.0	0.0	0.0	0.0	0.0	0.0	none

VARIABLE**DESCRIPTION**

MID	Material identification. A unique number or label must be specified (see *PART).
RO	Mass density
E	Young's modulus, E . Optionally, the Young's modulus can be a function of effective plastic strain. See Remark 5 . In that case this is the initial Young's modulus.
PR	Poisson's ratio, ν
M	the exponent in Barlat's yield criterion, m
R00	R_{00} , Lankford parameter in 0° direction
R45	R_{45} , Lankford parameter in 45° direction
R90	R_{90} , Lankford parameter in 90° direction

Card 2	1	2	3	4	5	6	7	8
Variable	CB	Y	SC	K	RSAT	SB	H	HLCID
Type	F	F	F	F	F	F	F	I
Default	0.0	0.0	0.0	0.0	0.0	0.0	0.0	none

VARIABLE**DESCRIPTION**

CB	The uppercase B defined in Yoshida's equations
----	--

VARIABLE	DESCRIPTION
Y	Hardening parameter as defined in Yoshida's equations
SC	The lowercase c defined in the Yoshida & Uemori's equations
K	Hardening parameter as defined in the Yoshida & Uemori's equations
RSAT	Hardening parameter as defined in the Yoshida and Uemori's equations
SB	The lowercase b as defined in the Yoshida & Uemori's equations
H	Anisotropic parameter associated with work-hardening stagnation, defined in the Yoshida and Uemori's equations
HLCID	Load curve ID (see *DEFINE_CURVE) giving true strain as a function of true stress. The load curve is optional and is used for error calculation only.

Card 3	1	2	3	4	5	6	7	8
Variable	AOPT	IOPT	C1	C2	IFLD	EA	COE	
Type	F	I	F	F	I	F	F	
Default	none	none	0.0	0.0	none	0.0	0.0	

VARIABLE	DESCRIPTION
AOPT	<p>Material axes option (see MAT_OPTIONTROPIC_ELASTIC for a more complete description):</p> <p>EQ.0.0: Locally orthotropic with material axes determined by element nodes 1, 2, and 4, as with *DEFINE_COORDINATE_NODES, and then rotated about the shell element normal by the angle BETA</p> <p>EQ.2.0: Globally orthotropic with material axes determined by vectors defined below, as with *DEFINE_COORDINATE_VECTOR</p>

VARIABLE	DESCRIPTION
----------	-------------

EQ.3.0:	Locally orthotropic material axes determined by rotating the material axes about the element normal by an angle, BETA, from a line in the plane of the element defined by the cross product of the vector v with the element normal
LT.0.0:	The absolute value of AOPT is a coordinate system ID number (CID on *DEFINE_COORDINATE_NODES, *DEFINE_COORDINATE_SYSTEM or *DEFINE_COORDINATE_VECTOR)..
IOPT	Kinematic hardening rule flag: EQ.0: Original Yoshida & Uemori formulation, EQ.1: Modified formulation; define C1, C2 as below.
C1, C2	Constants used to modify R: $R = RSAT \times [(C_1 + \bar{\epsilon}^p)^{c_2} - C_1^{c_2}]$
IFLD	ID of a load curve of the traditional Forming Limit Diagram (FLD) for the linear strain paths. In the load curve, abscissas represent minor strains while ordinates represent major strains. Define only when the NLP option is used.
EA	Variable controlling the change of Young's modulus, E^A . See Remark 5 .
COE	Variable controlling the change of Young's modulus, ζ . See Remark 5 .

Card 4	1	2	3	4	5	6	7	8
Variable				A1	A2	A3		
Type				F	F	F		

VARIABLE	DESCRIPTION
----------	-------------

A1, A2, A3	Components of vector a for AOPT = 2
------------	-------------------------------------

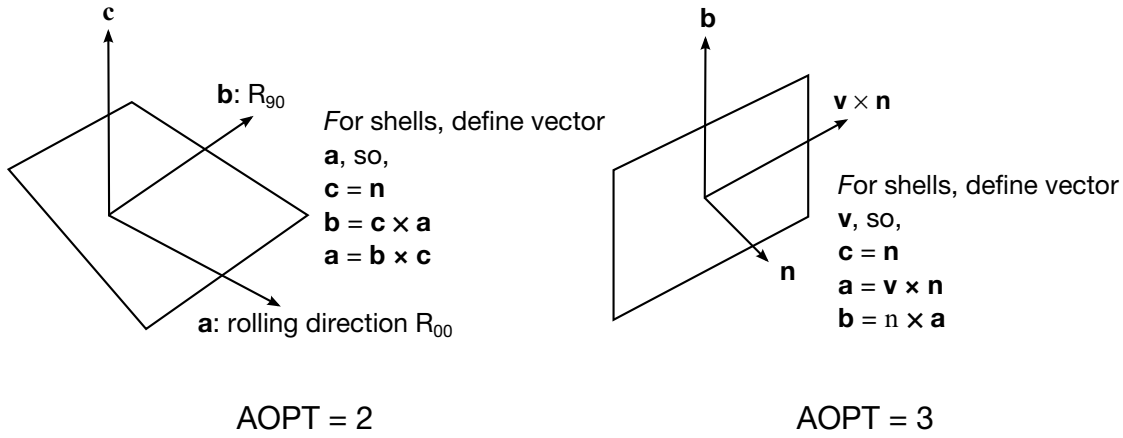

Figure M226-1. Defining sheet metal rolling direction.

Card 5	1	2	3	4	5	6	7	8
Variable	V1	V2	V3	D1	D2	D3	BETA	
Type	F	F	F	F	F	F	F	

VARIABLE

DESCRIPTION

V1, V2, V3

Components of vector v for AOPT = 3

D1, D2, D3

Components of vector d for AOPT = 2

BETA

Material angle in degrees for AOPT = 0 and 3, may be overridden on the element card; see *ELEMENT_SHELL_BETA.

Remarks:

- Barlat and Lian's Yield Criterion.** The R -values are defined as the ratio of instantaneous width change to instantaneous thickness change. That is, assume that the width W and thickness T are measured as functions of strain, then the corresponding R -value is given by:

$$R = \frac{\frac{dW}{d\varepsilon} / W}{\frac{dT}{d\varepsilon} / T}$$

Input R00, R45 and R90 to define sheet anisotropy in the rolling, 45° and 90° direction.

Barlat and Lian's [1989] anisotropic yield criterion Φ for plane stress is defined as:

$$\Phi = a|K_1 + K_2|^m + a|K_1 - K_2|^m + c|2K_2|^m = 2\sigma_Y^m$$

for face centered cubic (FCC) materials exponent $m = 8$ is recommended and for body centered cubic (BCC) materials $m = 6$ may be used. Detailed description on the criterion can be found in the *MAT_036 manual pages.

2. **Yoshida & Uemori Nonlinear Kinematic Hardening Model.** See manual pages for *MAT_125 for more details.
3. **Rolling Direction of Sheet Metal.** The variable AOPT is used to define the rolling direction of the sheet metals. When AOPT = 2, define vector components of \mathbf{a} in the direction of the rolling (R_{00}); when AOPT = 3, define vector components of \mathbf{v} perpendicular to the rolling direction, as shown in [Figure M226-1](#).
4. **A Failure Criterion for Nonlinear Strain Paths (NLP).** The NLP failure criterion and corresponding post processing procedures are described in the entries for *MAT_036 and *MAT_037. The history variables for every element stored in d3plot files include:

- a) Formability Index (F.I.): #1
- b) Strain ratio β (in-plane minor strain increment/major strain increment): #2
- c) Effective strain from the planar isotropic assumption: #3

To enable the output of these history variables to the d3plot files, NEIPS on the *DATABASE_EXTENT_BINARY card must be set to at least 3.

5. **Change in Young's Modulus.** The optional change in Young's modulus is defined as a function of effective plastic strain,

$$E = E_0 - (E_0 - E_A)[1 - \exp(-\zeta\bar{\epsilon}^p)] .$$

***MAT_PML_ELASTIC**

This is Material Type 230. This is a perfectly-matched layer (PML) material — an absorbing layer material used to simulate wave propagation in an unbounded isotropic elastic medium — and is available only for solid 8-node bricks (element type 2). This material implements the three-dimensional version of the Basu-Chopra PML [Basu and Chopra (2003,2004), Basu (2009)].

Card	1	2	3	4	5	6	7	8
Variable	MID	RO	E	PR				
Type	A	F	F	F				
Default	none	none	none	none				

VARIABLE**DESCRIPTION**

MID	Material identification. A unique number or label must be specified (see *PART).
RO	Mass density
E	Young's modulus
PR	Poisson's ratio

Remarks:

1. **Unboundedness.** A layer of this material may be placed at a boundary of a bounded domain to simulate unboundedness of the domain at that boundary: the layer absorbs and attenuates waves propagating outward from the domain, without any significant reflection of the waves back into the bounded domain. The layer cannot support any static displacement.
2. **Bounded Domain Material Properties.** It is assumed the material in the bounded domain near the layer is, or behaves like, an isotropic linear elastic material. The material properties of the layer should be set to the corresponding properties of this material.
3. **Layer Geometry.** The layer should form a cuboid box around the bounded domain, with the axes of the box aligned with the coordinate axes. Various faces

of this box may be open, as required by the geometry of the problem. For example, for a half-space problem, the “top” of the box should be open.

Internally, LS-DYNA will partition the entire PML into regions which form the “faces,” “edges” and “corners” of the above cuboid box, and generate a new material for each region. This partitioning will be visible in the d3plot file. The user may safely ignore this partitioning.

4. **Number of Elements in Layer.** The layer should have 5-10 elements through its depth. Typically, 5-6 elements are sufficient if the excitation source is reasonably distant from the layer, and 8-10 elements if it is close. The size of the elements should be similar to that of elements in the bounded domain near the layer and should be small enough to sufficiently discretize all significant wavelengths in the problem.
5. **Nodal Constraints.** The nodes on the outer boundary of the layer should be fully constrained using either *BOUNDARY_SPC or TC on *NODE. Other constraints, such as *CONSTRAINED_GLOBAL or *BOUNDARY_PRESCRIBED_MOTION with a zero-valued load curve, will not be recognized.

Note that Ansys Mechanical uses *BOUNDARY_PRESCRIBED_MOTION with a zero-value load curve for constraining nodal degrees-of-freedom. Because of this limitation, you will have to edit the input file with a text editor.

6. **Stress and Strain.** The stress and strain values reported by this material do not have any physical significance.

***MAT_PML_ELASTIC_FLUID**

This is Material Type 230_FLUID. This is a perfectly-matched layer (PML) material with a pressure fluid constitutive law, to be used in a wave-absorbing layer adjacent to a fluid material (*MAT_ELASTIC_FLUID) in order to simulate wave propagation in an unbounded fluid medium. See the Remarks sections of *MAT_PML_ELASTIC (*MAT_230) and *MAT_ELASTIC_FLUID (*MAT_001_FLUID) for further details.

Card	1	2	3	4	5	6	7	8
Variable	MID	RO	K	VC				
Type	A8	F	F	F				
Default	none	none	none	none				

VARIABLE**DESCRIPTION**

MID	Material identification. A unique number or label not exceeding 8 characters must be specified.
RO	Mass density
K	Bulk modulus
VC	Tensor viscosity coefficient

*MAT_PML_ACOUSTIC

This is Material Type 231. This is a perfectly-matched layer (PML) material — an absorbing layer material used to simulate wave propagation in an unbounded acoustic medium — and can be used only with the acoustic pressure element formulation (element type 14). This material implements the three-dimensional version of the Basu-Chopra PML for anti-plane motion [Basu and Chopra (2003,2004), Basu (2009)].

Card	1	2	3	4	5	6	7	8
Variable	MID	RO	C					
Type	A	F	F					
Default	none	none	none					

VARIABLE**DESCRIPTION**

MID	Material identification. A unique number or label must be specified (see *PART).
RO	Mass density
C	Sound speed

Remarks:

1. **Unboundedness.** A layer of this material may be placed at a boundary of a bounded domain to simulate unboundedness of the domain at that boundary: the layer absorbs and attenuates waves propagating outward from the domain, without any significant reflection of the waves back into the bounded domain. The layer cannot support any hydrostatic pressure.
2. **Material in Bounded Domain.** It is assumed the material in the bounded domain near the layer is an acoustic material. The material properties of the layer should be set to the corresponding properties of this material.
3. **Layer Geometry.** The layer should form a cuboid box around the bounded domain, with the axes of the box aligned with the coordinate axes. Various faces of this box may be open, as required by the geometry of the problem, e.g., for a half-space problem, the “top” of the box should be open.

Internally, LS-DYNA will partition the entire PML into regions which form the “faces,” “edges” and “corners” of the above cuboid box, and generate a new material for each region. This partitioning will be visible in the d3plot file. The user may safely ignore this partitioning.

4. **Number of Elements in Layer.** The layer should have 5 - 10 elements through its depth. Typically, 5 - 6 elements are sufficient if the excitation source is reasonably distant from the layer, and 8 - 10 elements if it is close. The size of the elements should be similar to that of elements in the bounded domain near the layer, and should be small enough to sufficiently discretize all significant wavelengths in the problem.
5. **Nodal Constraints.** The nodes on the outer boundary of the layer should be fully constrained using either *BOUNDARY_SPC or TC on *NODE. Other constraints, such as *CONSTRAINED_GLOBAL or *BOUNDARY_PRESCRIBED_MOTION with a zero-valued load curve, will not be recognized.

Note that Ansys Mechanical uses *BOUNDARY_PRESCRIBED_MOTION with a zero-value load curve for constraining nodal degrees-of-freedom. Because of this limitation, you will have to edit the input file with a text editor.

6. **Pressure Values.** The pressure values reported by this material do not have any physical significance.

*MAT_BIOT_HYSTERETIC

This is Material Type 232. This is a Biot linear hysteretic material, to be used for modeling the nearly-frequency-independent viscoelastic behavior of soils subjected to cyclic loading, such as in soil-structure interaction analysis [Spanos and Tsavachidis (2001), Makris and Zhang (2000), Muscolini, Palmeri and Ricciardelli (2005)]. The hysteretic damping coefficient for the model is computed from a prescribed damping ratio by calibrating with an equivalent viscous damping model for a single-degree-of-freedom system. The damping increases the stiffness of the model and thus reduces the computed time-step size.

Card	1	2	3	4	5	6	7	8
Variable	MID	RO	E	PR	ZT	FD		
Type	A8	F	F	F	F	F		
Default	none	none	none	none	0.0	3.25		

VARIABLE**DESCRIPTION**

MID	Material identification. A unique number or label not exceeding 8 characters must be specified.
RO	Mass density
E	Young's modulus
PR	Poisson's ratio
ZT	Damping ratio
FD	Dominant excitation frequency in Hz

Remarks:

1. **Stress.** The stress is computed as a function of the strain rate as

$$\sigma(t) = \int_0^t C_R(t - \tau) \dot{\epsilon}(\tau) d\tau$$

where

$$C_R(t) = C \left[1 + \frac{2\eta}{\pi} E_1(\beta t) \right].$$

In the above, C is the elastic isotropic constitutive tensor, η is the hysteretic damping factor, and $\beta = 2\pi f_d/10$, where f_d is the dominant excitation frequency in Hz. The function E_1 is given by

$$E_1(s) = \int_s^{\infty} \frac{e^{-\zeta}}{\zeta} d\zeta$$

For efficient implementation, this function is approximated by a 5-term Prony series as

$$E_1(s) \approx \sum_{k=1}^5 b_k e^{a_k s},$$

such that $b_k > 0$.

2. **Hysteretic Damping Factor.** The hysteretic damping factor η is obtained from the prescribed damping ratio ζ as

$$\eta = \pi\zeta/\text{atan}(10) = 2.14\zeta$$

by assuming that, for a single degree-of-freedom system, the energy dissipated per cycle by the hysteretic material is the same as that by a viscous damper, if the excitation frequency matches the natural frequency of the system.

3. **Young's Modulus.** The consistent Young's modulus for this model is given by

$$E_c = E \left[1 + \frac{2\eta}{\pi} g \right],$$

where

$$g = \sum_{k=1}^5 b_k \frac{1}{a_k \beta \Delta t_n} [\exp(a_k \beta \Delta t_n) - 1].$$

Because $g > 0$, the computed element time-step size is smaller than that for the corresponding elastic element. Furthermore, the time-step size computed at any time depends on the previous time-step size. It can be demonstrated that the new computed time-step size stays within a narrow range of the previous time-step size and for a uniform mesh, converges to a constant value. For $f_d = 3.25$ Hz and $\zeta = 0.05$, the percentage decrease in time-step size can be expected to be about 12 - 15% for initial time-step sizes of less than 0.02 secs, and about 7 - 10% for initial time-step sizes larger than 0.02 secs.

4. **Dominant Frequency.** The default value of the dominant frequency is chosen to be valid for earthquake excitation.

*MAT_CAZACU_BARLAT

This is Material Type 233. This material model is for Hexagonal Closed Packet (HCP) metals and is based on the work by Cazacu et al. (2006). This model is capable of describing the yielding asymmetry between tension and compression for such materials. Moreover, a parameter fit is optional and can be used to find the material parameters that describe the experimental yield stresses. The experimental data that you should supply consists of yield stresses for tension and compression in the 00 direction, tension in the 45 and the 90 directions, and a biaxial tension test.

Available options include:

<BLANK>

MAGNESIUM

Including MAGNESIUM invokes a material model developed by the USAMP consortium to simulate cast Magnesium under impact loading. The model includes rate effects having a tabulated failure model including equivalent plastic strain to failure as a function of stress triaxiality and effective plastic strain rate. Element erosion will occur when the number of integration points where the damage variable has reached unity reaches some specified threshold (NUMINT). Alternatively, a Gurson type failure model can be activated, which requires less experimental data.

You must provide the evolution of the Cazacu-Barlat effective stress as a function of the energy conjugate plastic strain in the input for the hardening curve for MAT_233. With the MAGNESIUM option an alternative option for the hardening curve is available: von Mises effective stress as a function of equivalent plastic strain, which is energy conjugate to the von Mises stress.

Finally, the MAGNESIUM option allows for distortional hardening by providing hardening curves as measured in tension and compression tests. This option is however incompatible with the activation of rate effects (visco-plasticity).

With the MAGNESIUM option this material model is also available for solid elements.

NOTE: Activating the MAGNESIUM options *requires* setting HR = 3 and FIT = 0.0 (also see below).

Card Summary:

Card 1. This card is required.

MID	RO	E	PR	HR	P1	P2	ITER
-----	----	---	----	----	----	----	------

Card 2. This card is required.

A	C11	C22	C33	LCID	E0	K	P3
---	-----	-----	-----	------	----	---	----

Card 3. This card is required.

AOPT				C12	C13	C23	C44
------	--	--	--	-----	-----	-----	-----

Card 4. This card is required.

XP	YP	ZP	A1	A2	A3		
----	----	----	----	----	----	--	--

Card 5. This card is required.

V1	V2	V3	D1	D2	D3	BETA	FIT
----	----	----	----	----	----	------	-----

Card 6. This card is included if and only if the MAGNESIUM keyword option is used.

LC1ID	LC2ID	NUMINT	LCCID	ICFLAG	IDFLAG	LC3ID	EPSFG
-------	-------	--------	-------	--------	--------	-------	-------

Data Card Definitions:

Card 1	1	2	3	4	5	6	7	8
Variable	MID	RO	E	PR	HR	P1	P2	ITER
Type	A	F	F	F	F	F	F	F

VARIABLE

DESCRIPTION

MID	Material identification. A unique number or label must be used (see *PART).
RO	Constant mass density
E	Young's modulus: GT.0.0: constant value LT.0.0: E is a load curve ID which defines the Young's modulus as a function of plastic strain.
PR	Poisson's ratio

VARIABLE	DESCRIPTION
HR	<p>Hardening rules:</p> <p>EQ.1.0: linear hardening (default)</p> <p>EQ.2.0: exponential hardening (Swift)</p> <p>EQ.3.0: load curve</p> <p>EQ.4.0: exponential hardening (Voce)</p> <p>EQ.5.0: exponential hardening (Gosh)</p> <p>EQ.6.0: exponential hardening (Hocken-Sherby)</p> <p>HR must be set to 3 if the MAGNESIUM keyword option is active.</p>
P1	<p>Material parameter:</p> <p>HR.EQ.1.0: tangent modulus</p> <p>HR.EQ.2.0: q, coefficient for exponential hardening law (Swift)</p> <p>HR.EQ.4.0: a, coefficient for exponential hardening law (Voce)</p> <p>HR.EQ.5.0: q, coefficient for exponential hardening law (Gosh)</p> <p>HR.EQ.6.0: a, coefficient for exponential hardening law (Hockett-Sherby)</p>
P2	<p>Material parameter:</p> <p>HR.EQ.1.0: yield stress for the linear hardening law</p> <p>HR.EQ.2.0: n, coefficient for (Swift) exponential hardening</p> <p>HR.EQ.4.0: c, coefficient for exponential hardening law (Voce)</p> <p>HR.EQ.5.0: n, coefficient for exponential hardening law (Gosh)</p> <p>HR.EQ.6.0: c, coefficient for exponential hardening law (Hockett-Sherby)</p>
ITER	<p>Iteration flag for speed:</p> <p>EQ.0.0: fully iterative</p> <p>EQ.1.0: fixed at three iterations. Generally, ITER = 0.0 is recommended. However, ITER = 1.0 is faster and may give acceptable results in most problems.</p>

Card 2	1	2	3	4	5	6	7	8
Variable	A	C11	C22	C33	LCID	E0	K	P3
Type	F	F	F	F	I	F	F	F

VARIABLE**DESCRIPTION**

A	Exponent in Cazacu-Barlat's orthotropic yield surface ($A > 1$)
C11	Material parameter (see Card 5 pos. 8): FIT.EQ.1.0 or EQ.2.0: yield stress for tension in the 00 direction FIT.EQ.0.0: material parameter c_{11}
C22	Material parameter (see Card 5 pos.8): FIT.EQ.1.0 or EQ.2.0: yield stress for tension in the 45 direction FIT.EQ.0.0: material parameter c_{22}
C33	Material parameter (see Card 5 pos.8): FIT.EQ.1.0 or EQ.2.0: yield stress for tension in the 90 direction FIT.EQ.0.0: material parameter c_{33}
LCID	Load curve ID for the hardening law ($HR = 3.0$), 2D Table ID for rate dependent hardening or 3D Table ID for rate-and-temperature-dependent hardening if the MAGNESIUM option is active. For the 3D table case, *MAT_ADD_THERMAL_EXPANSION could be used for thermal stress/strain effects. Note that the 3D table option is only valid for shell elements.
E0	Material parameter: HR.EQ.2.0: ϵ_0 , initial yield strain for exponential hardening law (Swift) (default = 0.0) HR.EQ.4.0: b , coefficient for exponential hardening (Voce) HR.EQ.5.0: ϵ_0 , initial yield strain for exponential hardening (Gosh); default = 0.0 HR.EQ.6.0: b , coefficient for exponential hardening law (Hockett-Sherby)

VARIABLE	DESCRIPTION
K	Material parameter (see Card 5 pos.8): FIT.EQ.1.0 or EQ.2.0: yield stress for compression in the 00 direction FIT.EQ.0.0: material parameter ($-1 < k < 1$)
P3	Material parameter: HR.EQ.5.0: p , coefficient for exponential hardening (Gosh) HR.EQ.6.0: n , exponent for exponential hardening law (Hockett-Sherby)

Card 3	1	2	3	4	5	6	7	8
Variable	AOPT				C12	C13	C23	C44
Type	F				F	F	F	F

VARIABLE	DESCRIPTION
AOPT	Material axes option (see *MAT_OPTIONTROPIC_ELASTIC for a more complete description). EQ.0.0: locally orthotropic with material axes determined by element nodes 1, 2 and 4, as with *DEFINE_COORDINATE_NODES, and then rotated about the shell element normal by the angle BETA EQ.1.0: locally orthotropic with material axes determined by a point in space and the global location of the element center; this is the a -direction. This option is for solid elements only. EQ.2.0: globally orthotropic with material axes determined by vectors defined below, as with *DEFINED_COORDINATE_VECTOR. EQ.3.0: locally orthotropic material axes determined by rotating the material axes about the element normal by an angle BETA, from a line in the plane of the element defined by the cross product of the vector, \mathbf{v} , with the element normal

VARIABLE	DESCRIPTION
-----------------	--------------------

EQ.4.0: locally orthotropic in cylindrical coordinate system with the material axes determined by a vector \mathbf{v} , and an originating point, p , which define the centerline axis. This option is for solid elements only.

LT.0.0: the absolute value of AOPT is a coordinate system ID number (CID on *DEFINE_COORDINATE_NODES, *DEFINE_COORDINATE_SYSTEM, or *DEFINE_COORDINATE_VECTOR).

C12 Material parameter, c_{12} . If parameter identification (FIT = 1.0) is turned on, C12 is not used.

C13 Material parameter, c_{13} . If parameter identification (FIT = 1.0) is turned on, C13 = 0.0

C23 Material parameter. If parameter identification (FIT = 1.0) is turned on, C23 = 0.0

C44 Material parameter (see Card 5 pos.8)
 FIT.EQ.1.0 or EQ.2.0: yield stress for the balanced biaxial tension test.
 FIT.EQ.0.0: material parameter, c_{44}

Card 4	1	2	3	4	5	6	7	8
Variable	XP	YP	ZP	A1	A2	A3		
Type	F	F	F	F	F	F		

VARIABLE	DESCRIPTION
-----------------	--------------------

XP - ZP Coordinates of point p for AOPT = 1 and 4

A1 - A3 Components of vector \mathbf{a} for AOPT = 2.0

Card 5	1	2	3	4	5	6	7	8
Variable	V1	V2	V3	D1	D2	D3	BETA	FIT
Type	F	F	F	F	F	F	F	I

VARIABLE**DESCRIPTION**

V1 - V3	Components of vector \mathbf{v} for AOPT = 3.0
D1 - D3	Components of vector \mathbf{d} for AOPT = 2.0
BETA	Material angle in degrees for AOPT = 0 and 3. Note that BETA may be overridden on the element card; see *ELEMENT_SHELL_BETA
FIT	Flag for parameter identification algorithm: <p>EQ.0.0: No parameter identification routine is used. The variables K, C11, C22, C33, C44, C12, C13 and C23 are interpreted as material parameters. FIT MUST be set to zero if MAGNESIUM option is active</p> <p>EQ.1.0: Parameter fit is used. The variables C11, C22, C33, C44 and K are interpreted as yield stresses in the 00 degree direction, the 45 degree direction, the 90 degree direction, the balanced biaxial tension, and the 00 degree compression, respectively. <i>It is recommended to always check the d3hsp file to see the fitted parameters before complex jobs are submitted.</i></p> <p>EQ.2.0: Same as EQ.1.0 but also produce contour plots of the yield surface. For each material three xy-data files are created: Contour1_n, Contour2_n and Contour3_n where <i>n</i> equals the material number.</p>

Magnesium Card. Additional card for MAGNESIUM keyword option.

Card 6	1	2	3	4	5	6	7	8
Variable	LC1ID	LC2ID	NUMINT	LCCID	ICFLAG	IDFLAG	LC3ID	EPSFG
Type	I	I	F	I	I	I	I	F

VARIABLE	DESCRIPTION
LC1ID	Load curve ID giving equivalent plastic strain to failure as a function of stress triaxiality or a table ID giving plastic strain to failure as a function of Lode parameter and stress triaxiality (solids)
LC2ID	Load curve ID giving equivalent plastic strain to failure as a function of equivalent plastic strain rate. The failure strain will be computed as the product of the values on LC1ID and LC2ID.
NUMINT	Number of through thickness integration points which must fail before the element is deleted (inactive for solid elements)
LCCID	Load curve ID giving effective stress as a function of plastic strain obtained from a compression stress. This load curve will activate distortional hardening. It is <i>not</i> compatible with the use of strain rate effects.
ICFLAG	Automated input conversion flag: EQ.0: load curves provided under LCID and LCCID contain Cazacu-Barlat effective stress as a function of energy conjugate plastic strain. EQ.1: both load curves are given in terms of von Mises stress as a function of equivalent plastic strain
IDFLAG	Damage flag: EQ.0: failure model is of the Johnson Cook type and requires LC1ID and LC2ID as additional input. EQ.1: failure model is of the Gurson type and requires LC3ID and EPSFG as additional input.
LC3ID	Load curve giving the critical void fraction of the Gurson model as a function of the plastic strain to failure measured in the uniaxial tensile test
EPSFG	Plastic strain to failure measured in the uniaxial tensile test. This value is used by the Gurson type failure model only.

Remarks:

This material model (*MAT_CAZACU_BARLAT) aims to model materials with strength differential and orthotropic behavior under plane stress. The yield condition includes a parameter k that describes the asymmetry between yield in tension and compression. Moreover, to include the anisotropic behavior the stress deviator, S , undergoes a linear

transformation. The principal values of the Cauchy stress deviator are substituted with the principal values of the transformed tensor, \mathbf{Z} , which is represented as a vector field, defined as:

$$\mathbf{Z} = \mathbf{C} \mathbf{S} . \quad (233.1)$$

Here \mathbf{S} is the field comprised of the four stresses deviator components, $S_I = (s_{11}, s_{22}, s_{33}, s_{12})$,

$$\mathbf{s} = \boldsymbol{\sigma} - \frac{1}{3} \text{tr}(\boldsymbol{\sigma}) \boldsymbol{\delta} .$$

In the above equation, $\text{tr}(\boldsymbol{\sigma})$ is the trace of the Cauchy stress tensor and $\boldsymbol{\delta}$ is the Kronecker delta. For the 2D plane stress condition, the orthotropic condition gives 7 independent coefficients. The tensor \mathbf{C} is represented by the 4×4 matrix

$$C_{IJ} = \begin{pmatrix} c_{11} & c_{12} & c_{13} & \\ c_{12} & c_{22} & c_{23} & \\ c_{13} & c_{23} & c_{33} & \\ & & & c_{44} \end{pmatrix} .$$

The principal values of \mathbf{Z} are denoted Σ_1, Σ_2 , and Σ_3 and are given as the eigenvalues to the matrix composed by the components $\Sigma_{xx}, \Sigma_{yy}, \Sigma_{zz}$, and Σ_{xy} through

$$\begin{aligned} \Sigma_1 &= \frac{1}{2} \left(\Sigma_{xx} + \Sigma_{yy} + \sqrt{(\Sigma_{xx} - \Sigma_{yy})^2 + 4\Sigma_{xy}^2} \right) , \\ \Sigma_2 &= \frac{1}{2} \left(\Sigma_{xx} + \Sigma_{yy} - \sqrt{(\Sigma_{xx} - \Sigma_{yy})^2 + 4\Sigma_{xy}^2} \right) , \\ \Sigma_3 &= \Sigma_{zz} \end{aligned}$$

where

$$\begin{aligned} 3\Sigma_{xx} &= (2c_{11} - c_{12} - c_{13})\sigma_{xx} + (-c_{11} + 2c_{12} - c_{13})\sigma_{yy} , \\ 3\Sigma_{yy} &= (2c_{12} - c_{22} - c_{23})\sigma_{xx} + (-c_{12} + 2c_{22} - c_{23})\sigma_{yy} , \\ 3\Sigma_{zz} &= (2c_{13} - c_{23} - c_{33})\sigma_{xx} + (-c_{13} + 2c_{23} - c_{33})\sigma_{yy} , \\ \Sigma_{xy} &= c_{44}\sigma_{12} \end{aligned}$$

Note that the symmetry of Σ_{xy} follows from the symmetry of the Cauchy stress tensor.

The yield condition is written in the following form:

$$f(\Sigma, k, \varepsilon_{ep}) = \sigma_{\text{eff}}(\Sigma_1, \Sigma_2, \Sigma_3, k) - \sigma_y(\varepsilon_{ep}) \leq 0 , \quad (233.2)$$

where $\sigma_y(\varepsilon_{ep})$ is a function representing the current yield stress dependent on current effective plastic strain and k is the asymmetric parameter for yield in compression and tension. The effective stress σ_{eff} is given by

$$\sigma_{\text{eff}} = [(|\Sigma_1| - k\Sigma_1)^a + (|\Sigma_2| - k\Sigma_2)^a + (|\Sigma_3| - k\Sigma_3)^a]^{1/a} , \quad (233.3)$$

where $k \in [-1, 1]$ and $a \geq 1$. Now, let σ_{00}^T and σ_{00}^C represent the yield stress along the rolling (00 degree) direction in tension and compression, respectively. Furthermore let σ_{45}^T and σ_{90}^T represent the yield stresses in the 45 and the 90 degree directions, and last let

σ_B^T be the balanced biaxial yield stress in tension. Following Cazacu et al. (2006) the yield stresses can easily be derived.

To simplify the equations it is preferable to make the following definitions:

$$\begin{aligned} \Phi_1 &= \frac{1}{3}(2c_{11} - c_{12} - c_{13}) & \Psi_1 &= \frac{1}{3}(-c_{11} + 2c_{12} - c_{13}) \\ \Phi_2 &= \frac{1}{3}(2c_{12} - c_{22} - c_{23}) \quad \text{and} & \Psi_2 &= \frac{1}{3}(-c_{12} + 2c_{22} - c_{23}) \\ \Phi_3 &= \frac{1}{3}(2c_{13} - c_{23} - c_{33}) & \Psi_3 &= \frac{1}{3}(-c_{13} + 2c_{23} - c_{33}) \end{aligned}$$

The yield stresses can now be written as:

1. In the 00 degree direction:

$$\begin{aligned} \sigma_{00}^T &= \left[\frac{(\sigma_{\text{eff}})^a}{(|\Phi_1| - k\Phi_1)^a + (|\Phi_2| - k\Phi_2)^a + (|\Phi_3| - k\Phi_3)^a} \right]^{1/a}, \\ \sigma_{00}^C &= \left[\frac{(\sigma_{\text{eff}})^a}{(|\Phi_1| + k\Phi_1)^a + (|\Phi_2| + k\Phi_2)^a + (|\Phi_3| + k\Phi_3)^a} \right]^{1/a} \end{aligned} \quad (233.4)$$

2. In the 45 degree direction:

$$\sigma_{45}^T = \left[\frac{(\sigma_{\text{eff}})^a}{(|\Lambda_1| - k\Lambda_1)^a + (|\Lambda_2| - k\Lambda_2)^a + (|\Lambda_3| - k\Lambda_3)^a} \right]^{1/a} \quad (233.5)$$

where

$$\begin{aligned} \Lambda_1 &= \frac{1}{4} \left[\Phi_1 + \Phi_2 + \Psi_1 + \Psi_2 + \sqrt{(\Phi_1 + \Psi_1 - \Phi_2 - \Psi_2)^2 + 4c_{44}^2} \right], \\ \Lambda_2 &= \frac{1}{4} \left[\Phi_1 + \Phi_2 + \Psi_1 + \Psi_2 - \sqrt{(\Phi_1 + \Psi_1 - \Phi_2 - \Psi_2)^2 + 4c_{44}^2} \right], \\ \Lambda_3 &= \frac{1}{2} [\Phi_3 + \Psi_3]. \end{aligned}$$

3. In the 90 degree direction:

$$\sigma_{90}^T = \left[\frac{(\sigma_{\text{eff}})^a}{(|\Psi_1| - k\Psi_1)^a + (|\Psi_2| - k\Psi_2)^a + (|\Psi_3| - k\Psi_3)^a} \right]^{1/a} \quad (233.6)$$

4. In the balanced biaxial yield occurs when both σ_{xx} and σ_{yy} are equal to:

$$\sigma_B^T = \left[\frac{(\sigma_{\text{eff}})^a}{(|\Omega_1| - k\Omega_1)^a + (|\Omega_2| - k\Omega_2)^a + (|\Omega_3| - k\Omega_3)^a} \right]^{1/a} \quad (233.7)$$

where

$$\Omega_1 = \frac{1}{3}(c_{11} + c_{12} - 2c_{13})$$

$$\Omega_2 = \frac{1}{3}(c_{12} + c_{22} - 2c_{23})$$

$$\Omega_3 = \frac{1}{3}(c_{13} + c_{23} - 2c_{33})$$

Hardening laws:

The following hardening laws are implemented:

1. Swift hardening law
2. Voce hardening law
3. Gosh hardening law
4. Hocket-Sherby hardening law
5. Loading curve, where the yield stress is given as a function of the effective plastic strain

The Swift's hardening law can be written as

$$\sigma_y(\varepsilon_{ep}) = q(\varepsilon_0 + \varepsilon_{ep})^n$$

where q and n are material parameters.

The Voce's equation says that the yield stress can be written in the following form

$$\sigma_y(\varepsilon_{ep}) = a - be^{-c\varepsilon_{ep}}$$

where a , b , and c are material parameters. The Gosh's equation is similar to Swift's equation. They only differ by a constant

$$\sigma_y(\varepsilon_{ep}) = q(\varepsilon_0 + \varepsilon_{ep})^n - p .$$

Here q , ε_0 , n and p are material constants. The Hocket-Sherby equation resembles the Voce's equation, but with an additional parameter added

$$\sigma_y(\varepsilon_{ep}) = a - be^{-c\varepsilon_{ep}^n} ,$$

where a , b , c and n are material parameters.

Constitutive relation and material stiffness:

The classical elastic constitutive equation for linear deformations is the well-known Hooke's law. This relation written in a rate formulation is given by

$$\dot{\sigma} = \mathbf{D}\dot{\varepsilon}_e , \quad (233.8)$$

where ε_e is the elastic strain and \mathbf{D} is the constitutive matrix. An over imposed dot indicates differentiation respect to time. Introducing the total strain, ε , and the plastic strain, ε_p , Eq. (233.8) is classically rewritten as

$$\dot{\sigma} = \mathbf{D}(\dot{\varepsilon} - \dot{\varepsilon}_p) , \quad (233.9)$$

where

$$\mathbf{D} = \frac{E}{1-\nu^2} \begin{pmatrix} 1 & \nu & & & & \\ \nu & 1 & & & & \\ & & \frac{1-\nu}{2} & & & \\ & & & \frac{1-\nu}{2} & & \\ & & & & \frac{1-\nu}{2} & \\ & & & & & \frac{1-\nu}{2} \end{pmatrix} \text{ and } (\dot{\varepsilon} - \dot{\varepsilon}_p) = \begin{pmatrix} \dot{\varepsilon}_{11} - (\dot{\varepsilon}_p)_{11} \\ \dot{\varepsilon}_{22} - (\dot{\varepsilon}_p)_{22} \\ 2[\dot{\varepsilon}_{12} - (\dot{\varepsilon}_p)_{12}] \\ 2[\dot{\varepsilon}_{13} - (\dot{\varepsilon}_p)_{13}] \\ 2[\dot{\varepsilon}_{23} - (\dot{\varepsilon}_p)_{23}] \end{pmatrix} .$$

The parameters E and ν are the Young's modulus and Poisson's ratio, respectively.

The material stiffness \mathbf{D}_p that is needed for implicit analysis can be calculated from [Equation \(233.9\)](#) as

$$\mathbf{D}_p = \frac{\partial \dot{\sigma}}{\partial \dot{\varepsilon}} .$$

The associative flow rule for the plastic strain is usually written as

$$\dot{\varepsilon}_p = \lambda \frac{\partial f}{\partial \sigma} , \quad (233.10)$$

and the consistency condition reads as

$$\frac{df}{d\sigma} \dot{\sigma} + \frac{df}{d\varepsilon_{ep}} \dot{\varepsilon}_{ep} = 0 . \quad (233.11)$$

Note that the centralized "dot" means scalar product between two vectors. Using standard calculus one easily derives from [Equations \(233.9\)](#), [\(233.10\)](#) and [\(233.11\)](#) an expression for the stress rate

$$\dot{\sigma} = \left[\mathbf{D} - \frac{\left(\mathbf{D} \frac{df}{d\sigma} \right) \cdot \left(\mathbf{D} \frac{df}{d\sigma} \right)}{\frac{df}{d\sigma} \cdot \left(\mathbf{D} \frac{df}{d\sigma} \right) - \frac{df}{d\varepsilon_{ep}}} \right] \dot{\varepsilon} \quad (233.12)$$

That means that the material stiffness used for implicit analysis is given by

$$\mathbf{D}_p = \mathbf{D} - \frac{\left(\mathbf{D} \frac{df}{d\sigma} \right) \cdot \left(\mathbf{D} \frac{df}{d\sigma} \right)}{\frac{df}{d\sigma} \cdot \left(\mathbf{D} \frac{df}{d\sigma} \right) - \frac{df}{d\varepsilon_{ep}}} . \quad (233.13)$$

To be able to do a stress update we need to calculate the tangent stiffness and the derivative with respect to the corresponding hardening law.

When a suitable hardening law has been chosen the corresponding derivative is simple and will be left out from this document. However, the stress gradient of the yield surface is more complicated and will be outlined here.

$$\begin{aligned} \frac{\partial f}{\partial \sigma_{11}} = & \frac{\partial f}{\partial \Sigma_3} \frac{1}{2} \frac{\partial f}{\partial \Sigma_1} \left[\left(1 + \frac{\Sigma_{xx} - \Sigma_{yy}}{\sqrt{\Sigma_T}} \right) \Phi_1 + \left(1 - \frac{\Sigma_{xx} - \Sigma_{yy}}{\sqrt{\Sigma_T}} \right) \Phi_2 \right] \\ & + \frac{1}{2} \frac{\partial f}{\partial \Sigma_2} \left[\left(1 - \frac{\Sigma_{xx} - \Sigma_{yy}}{\sqrt{\Sigma_T}} \right) \Phi_1 + \left(1 + \frac{\Sigma_{xx} - \Sigma_{yy}}{\sqrt{\Sigma_T}} \right) \Phi_2 \right] + \Phi_3 \end{aligned} \quad (233.14)$$

$$\begin{aligned} \frac{\partial f}{\partial \sigma_{22}} = & \frac{1}{2} \frac{\partial f}{\partial \Sigma_1} \left[\left(1 + \frac{\Sigma_{xx} - \Sigma_{yy}}{\sqrt{\Sigma_T}} \right) \Psi_1 + \left(1 - \frac{\Sigma_{xx} - \Sigma_{yy}}{\sqrt{\Sigma_T}} \right) \Psi_2 \right] \\ & + \frac{1}{2} \frac{\partial f}{\partial \Sigma_2} \left[\left(1 - \frac{\Sigma_{xx} - \Sigma_{yy}}{\sqrt{\Sigma_T}} \right) \Psi_1 + \left(1 + \frac{\Sigma_{xx} - \Sigma_{yy}}{\sqrt{\Sigma_T}} \right) \Psi_2 \right] + \frac{\partial f}{\partial \Sigma_3} \Psi_3 \end{aligned} \quad (233.15)$$

and the derivative with respect to the shear stress component is

$$\frac{\partial f}{\partial \sigma_{12}} = c_{44} \frac{2\Sigma_{xy}}{\sqrt{\Sigma_T}} \left(\frac{\partial f}{\partial \Sigma_1} - \frac{\partial f}{\partial \Sigma_2} \right) \quad (233.16)$$

where

$$\Sigma_T = (\Sigma_{xx} - \Sigma_{yy})^2 + 4\Sigma_{xy}^2 \quad (233.17)$$

and

$$\frac{\partial f}{\partial \Sigma_i} = f(\Sigma, k, \varepsilon_{ep})^{\frac{1}{a}-1} (|\Sigma_i| - k\Sigma_i)^{a-1} (\text{sgn}(\Sigma_i) - k) \quad \text{for } i = 1,2,3 \quad (233.18)$$

Implementation:

Assume that the stress and strain is known at time t^n . A trial stress $\tilde{\sigma}^{n+1}$ at time t^{n+1} is calculated by assuming a pure elastic deformation, that is,

$$\tilde{\sigma}^{n+1} = \sigma^n + \mathbf{D}(\boldsymbol{\varepsilon}^{n+1} - \boldsymbol{\varepsilon}^n) \quad (233.19)$$

Now, if $f(\Sigma, k, \varepsilon_{ep}) \leq 0$, the deformation is purely elastic, and the new stress and plastic strain are determined as

$$\begin{aligned} \sigma^{n+1} &= \tilde{\sigma}^{n+1} \\ \varepsilon_{ep}^{n+1} &= \varepsilon_{ep}^n \end{aligned} \quad (233.20)$$

The thickness strain increment is given by

$$\Delta \varepsilon_{33} = \varepsilon_{33}^{n+1} - \varepsilon_{33}^n = -\frac{\nu}{1-\nu} (\Delta \varepsilon_{11} + \Delta \varepsilon_{22}) \quad (233.21)$$

If the deformation is not purely elastic, the stress is not inside the yield surface and a plastic iterative procedure must take place as described in the following:

1. Set $m = 0$, $\sigma_{(0)}^{n+1} = \tilde{\sigma}^{n+1}$, $\varepsilon_{ep(0)}^{n+1} = \varepsilon_{ep}^n$ and $\Delta\varepsilon_{11}^{p(0)} = \Delta\varepsilon_{22}^{p(0)} = 0$
2. Determine the plastic multiplier as

$$\Delta\lambda = \frac{f(\sigma_{(m)}^{n+1}, \varepsilon_{ep(m)}^{n+1})}{\frac{df}{d\sigma}(\sigma_{(m)}^{n+1}) \cdot \mathbf{D} \frac{df}{d\sigma}(\sigma_{(m)}^{n+1}) - \frac{df}{d\varepsilon_{ep}}(\varepsilon_{ep(m)}^{n+1})} \quad (233.22)$$

3. Perform a plastic corrector step: $\sigma_{(m+1)}^{n+1} = \sigma_{(m)}^{n+1} - \Delta\lambda \mathbf{D} \frac{df}{d\sigma}(\sigma_{(m)}^{n+1})$ and find the increments in plastic strain according to

$$\begin{aligned} \varepsilon_{ep(m+1)}^{n+1} &= \varepsilon_{ep(m)}^{n+1} + \Delta\lambda \\ \Delta\varepsilon_{11}^{p(n+1)} &= \Delta\varepsilon_{11}^{p(n)} + \Delta\lambda \frac{\partial f}{\partial \sigma_{11}}(\sigma_{(m)}^{n+1}) \\ \Delta\varepsilon_{22}^{p(n+1)} &= \Delta\varepsilon_{22}^{p(n)} + \Delta\lambda \frac{\partial f}{\partial \sigma_{22}}(\sigma_{(m)}^{n+1}) \end{aligned} \quad (233.23)$$

4. If $|f(\sigma_{(m+1)}^{n+1}, \varepsilon_{ep}^n)| < \text{tol}$ or $m = m_{\max}$; stop and set

$$\begin{aligned} \sigma^{n+1} &= \sigma_{(m+1)}^{n+1}, \\ \varepsilon_{ep}^{n+1} &= \varepsilon_{ep(m+1)}^{n+1}, \\ \Delta\varepsilon_{11}^p &= \Delta\varepsilon_{11}^{p(m+1)}, \\ \Delta\varepsilon_{22}^p &= \Delta\varepsilon_{22}^{p(m+1)}. \end{aligned} \quad (233.24)$$

Otherwise set $m = m + 1$ and return to 2.

The thickness strain increment for plastic yield is calculated as

$$\Delta\varepsilon_{33} = -\frac{1}{1-\nu}(\Delta\varepsilon_{11} + \Delta\varepsilon_{22}) - \left(1 - \frac{\nu}{1-\nu}\right)(\Delta\varepsilon_{11}^p + \Delta\varepsilon_{22}^p) \quad (233.25)$$

History Variables for the MAGNESIUM keyword option:

The following history variables will be stored for the MAGNESIUM option:

History Variable #	Description
10	Gurson damage
11	Void fraction

History Variable #	Description
12	Void fraction star
14	Damage
15	Plastic strain to failure
17	Equivalent plastic strain (energy conjugate to von Mises stress)
19	Effective stress (Cazacu-Barlat)

***MAT_VISCOELASTIC_LOOSE_FABRIC**

This is Material Type 234 developed and implemented by Tabiei et al [2004]. The model is a mechanism incorporating the crimping of the fibers as well as the trellising with re-orientation of the yarns and the locking phenomenon observed in loose fabric. The equilibrium of the mechanism allows the straightening of the fibers depending on the fiber tension. The contact force at the fiber cross over point determines the rotational friction that dissipates a part of the impact energy. The stress-strain relationship is viscoelastic based on a three-element model. The failure of the fibers is strain rate dependent. *DAMPING_PART_MASS is recommended to be used in conjunction with this material model. This material is valid for modeling the elastic and viscoelastic response of loose fabric used in body armor, blade containments, and airbags.

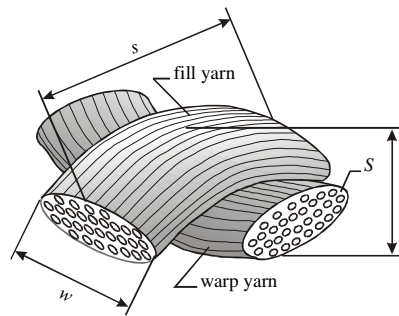

Figure M234-1. Representative Volume Cell (RVC) of the model

Card 1	1	2	3	4	5	6	7	8
Variable	MID	R0	E1	E2	G12	EU	THL	THI
Type	A8	F	F	F	F	F	F	F

Card 2	1	2	3	4	5	6	7	8
Variable	TA	W	s	T	H	S	EKA	EUA
Type	F	F	F	F	F	F	F	F

Card 3	1	2	3	4	5	6	7	8
Variable	VMB	C	G23	EKB	AOPT			
Type	F	F	F	F	F			

Card 4	1	2	3	4	5	6	7	8
Variable				A1	A2	A3		
Type				F	F	F		

Card 5	1	2	3	4	5	6	7	8
Variable	V1	V2	V3	D1	D2	D3		
Type	F	F	F	F	F	F		

VARIABLE**DESCRIPTION**

MID	Material identification. A unique number or label not exceeding 8 characters must be specified.
RO	Mass density
E1	E_1 , Young's modulus in the yarn axial-direction.
E2	E_2 , Young's modulus in the yarn transverse-direction
G12	G_{12} , shear modulus of the yarns
EU	Ultimate strain at failure
THL	Yarn locking angle
THI	Initial braid angle
TA	Transition angle to locking
W	Fiber width

VARIABLE	DESCRIPTION
s	Span between the fibers
T	Real fiber thickness
H	Effective fiber thickness
S	Fiber cross-sectional area
EKA	Elastic constant of element "a"
EUA	Ultimate strain of element "a"
VMB	Damping coefficient of element "b"
C	Coefficient of friction between the fibers
G23	Transverse shear modulus
EKB	Elastic constant of element "b"
AOPT	Material axes option (see <code>MAT_OPTIONTROPIC_ELASTIC</code> for a more complete description). EQ.0.0: locally orthotropic with material axes determined by element nodes 1, 2 and 4, as with <code>*DEFINE_COORDINATE_NODES</code> EQ.2.0: globally orthotropic with material axes determined by vectors defined below, as with <code>*DEFINED_COORDINATE_VECTOR</code> EQ.3.0: locally orthotropic material axes defined by the cross product of the vector \mathbf{v} with the element normal LT.0.0: the absolute value of AOPT is a coordinate system ID number (CID on <code>*DEFINE_COORDINATE_NODES</code> , <code>*DEFINE_COORDINATE_SYSTEM</code> , or <code>*DEFINE_COORDINATE_VECTOR</code>).
A1 - A3	Components of vector \mathbf{a} for AOPT = 2.0
V1 - V3	Components of vector \mathbf{v} for AOPT = 3.0
D1 - D3	Components of vector \mathbf{d} for AOPT = 2.0

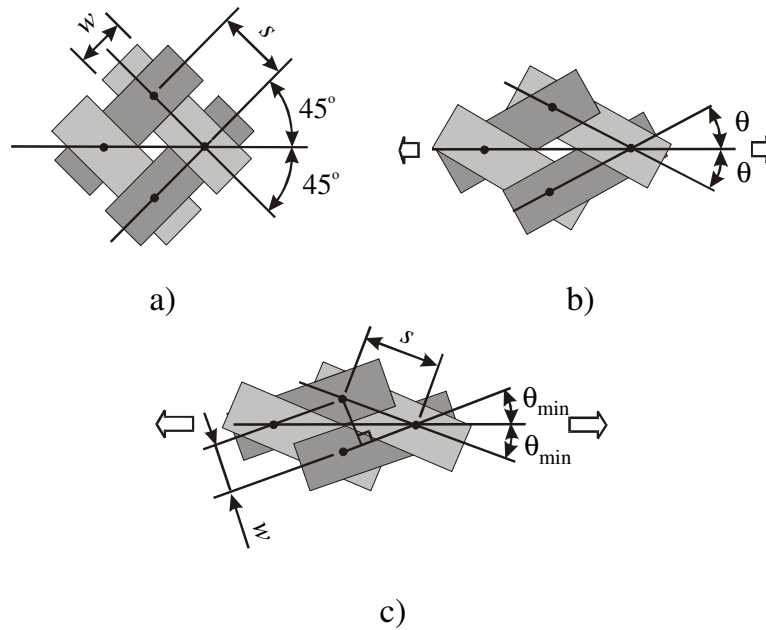

Figure M234-2. Plain woven fabric as trellis mechanism: a) initial state; b) slightly stretched in bias direction; c) stretched to locking.

Remarks:

The parameters of the Representative Volume Cell (RVC) are: the yarn span, s , the fabric thickness, t , the yarn width, w , and the yarn cross-sectional area, A . The initially orthogonal yarns (see Figure M234-2a) are free to rotate (see Figure M234-2b) up to some angle and after that the lateral contact between the yarns causes the locking of the trellis mechanism and the packing of the yarns (see Figure M234-2c). The minimum braid angle, θ_{\min} , can be calculated from the geometry and the architecture of the fabric material having the yarn width, w , and the span between the yarns, s :

$$\sin(2\theta_{\min}) = \frac{w}{s} .$$

The range angle, θ_{lock} , and the maximum braid angle, θ_{max} , are then easily determined as:

$$\theta_{\text{lock}} = 45^\circ - \theta_{\min} , \quad \theta_{\text{max}} = 45^\circ + \theta_{\text{lock}}$$

The material behavior of the yarn can be simply described by a combination of one Maxwell element without the dashpot and one Kelvin-Voigt element. The 1-D model of viscoelasticity is shown in Figure M234-3. The differential equation of viscoelasticity of the yarns can be derived from the model equilibrium as in the following equation:

$$(K_a + K_b)\sigma + \mu_b \dot{\sigma} = K_a K_b \varepsilon + \mu_b K_a \dot{\varepsilon}$$

The input parameters for the viscoelasticity model of the material are only the static Young's modulus E_1 , the Hookian spring coefficient (EKA) K_a , the viscosity coefficient

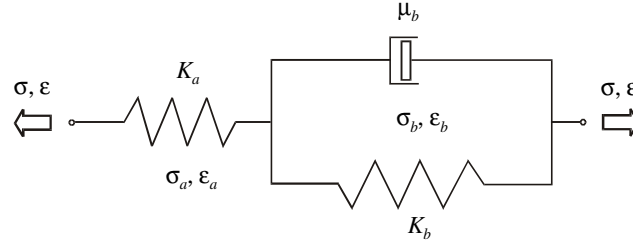

Figure M234-3. Three-element viscoelasticity model

(VMB) μ_b , the static ultimate strain (EU) ϵ_{\max} , and the Hookian spring ultimate strain (EUA) $\epsilon_{a,\max}$. The other parameters can be obtained as follows:

$$K_b = \frac{K_a E_1}{K_a - E_1}$$

$$\epsilon_{b,\max} = \frac{K_a - E_1}{K_a} \epsilon_{\max}$$

The stress in the yarns for the fill and warp is updated for the next time step as:

$$\sigma_f^{(n+1)} = \sigma_f^{(n)} + \Delta\sigma_f^{(n)}, \quad \sigma_w^{(n+1)} = \sigma_w^{(n)} + \Delta\sigma_w^{(n)}$$

where $\Delta\sigma_f$ and $\Delta\sigma_w$ are the stress increments in the yarns. We can imagine that the RVC is smeared to the parallelepiped in order to transform the stress acting on the yarn cross-section to the stress acting on the element wall. The thickness of the membrane shell element used should be equal to the effective thickness, t_e , that can be found by dividing the areal density of the fabric by its mass density. The in-plane stress components acting on the RVC walls in the material direction of the yarns are calculated as follows for the fill and warp directions:

$$\sigma_{f11}^{(n+1)} = \frac{2\sigma_f^{(n+1)} S}{st_e} \quad \sigma_{w11}^{(n+1)} = \frac{2\sigma_w^{(n+1)} S}{st_e}$$

$$\sigma_{f22}^{(n+1)} = \sigma_{f22}^{(n)} + \alpha E_2 \Delta\epsilon_{f22}^{(n)} \quad \sigma_{w22}^{(n+1)} = \sigma_{w22}^{(n)} + \alpha E_2 \Delta\epsilon_{w22}^{(n)}$$

$$\sigma_{f12}^{(n+1)} = \sigma_{f12}^{(n)} + \alpha G_{12} \Delta\epsilon_{f12}^{(n)} \quad \sigma_{w12}^{(n+1)} = \sigma_{w12}^{(n)} + \alpha G_{12} \Delta\epsilon_{w12}^{(n)}$$

where E_2 is the transverse Young's modulus of the yarns, G_{12} is the longitudinal shear modulus, and α is the lateral contact factor. The lateral contact factor is zero when the trellis mechanism is open and unity if the mechanism is locked with full lateral contact between the yarns. There is a transition range, $\Delta\theta \times TA$, of the average braid angle, θ , in

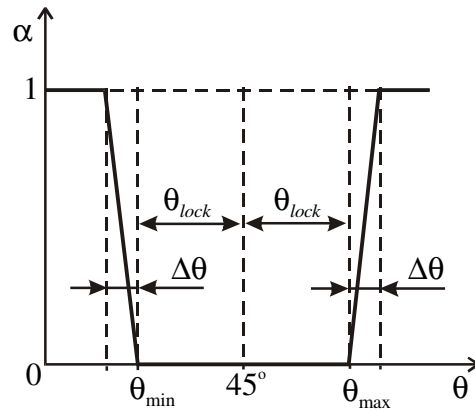

Figure M234-4. The lateral contact factor as a function of average braid angle, θ .

which the lateral contact factor, α , is a linear function of the average braid angle. The graph of the function $\alpha(\theta)$ is shown in [Figure M234-4](#).

***MAT_MICROMECHANICS_DRY_FABRIC**

This is Material Type 235 developed and implemented by Tabiei et al [2001]. The material model derivation includes the micro-mechanical approach and the homogenization technique usually used in composite material models. The model accounts for reorientation of the yarns and the fabric architecture. The behavior of the flexible fabric material is achieved by discounting the shear moduli of the material in free state which allows the simulation of the trellis mechanism before packing the yarns. This material is valid for modeling the elastic response of loose fabric used in inflatable structures, parachutes, body armor, blade containments, and airbags.

Card 1	1	2	3	4	5	6	7	8
Variable	MID	RO	E1	E2	G12	G23	V12	V23
Type	A8	F	F	F	F	F	F	F

Card 2	1	2	3	4	5	6	7	8
Variable	XT	THI	THL	BFI	BWI	DSCF	CNST	ATLR
Type	F	F	F	F	F	F	F	F

Card 3	1	2	3	4	5	6	7	8
Variable	VME	VMS	TRS	FFLG	AOPT			
Type	F	F	F	F	F			

Card 4	1	2	3	4	5	6	7	8
Variable				A1	A2	A3		
Type				F	F	F		

Card 5	1	2	3	4	5	6	7	8
Variable	V1	V2	V3	D1	D2	D3		
Type	F	F	F	F	F	F		

VARIABLE**DESCRIPTION**

MID	Material identification. A unique number or label not exceeding 8 characters must be specified.
RO	Mass density
E1	E_1 , Young's modulus of the yarn in the axial-direction
E2	E_2 , Young's modulus of the yarn in the transverse-direction
G12	G_{12} , shear modulus of the yarns.
G23	G_{23} , transverse shear modulus of the yarns.
V12	Poisson's ratio
V23	Transverse Poisson's ratio
XT	Stress or strain to failure (see FFLG)
THI	Initial braid angle
THL	Yarn locking angle
BFI	Initial undulation angle in fill direction
BWI	Initial undulation angle in warp direction
DSCF	Discount factor
CNST	Reorientation damping constant
ATLR	Angle tolerance for locking
VME	Viscous modulus for normal strain rate
VMS	Viscous modulus for shear strain rate
TRS	Transverse shear modulus of the fabric layer

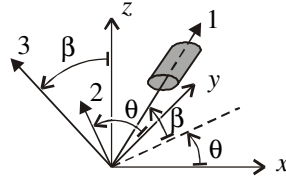

Figure M235-1. Yarn orientation schematic.

VARIABLE	DESCRIPTION
FFLG	Flag for stress-based or strain-based failure: EQ.0: XT is a stress to failure. NE.0: XT is a strain to failure.
AOPT	Material axes option (see MAT_OPTIONTROPIC_ELASTIC for more complete description). EQ.0.0: locally orthotropic with material axes determined by element nodes 1, 2 and 4, as with *DEFINE_COORDINATE_NODES EQ.2.0: globally orthotropic with material axes determined by vectors defined below, as with *DEFINED_COORDINATE_VECTOR EQ.3.0: locally orthotropic material axes defined by the cross product of the vector v with the element normal LT.0.0: the absolute value of AOPT is a coordinate system ID number (CID on *DEFINE_COORDINATE_NODES, *DEFINE_COORDINATE_SYSTEM, or *DEFINE_COORDINATE_VECTOR).
A1 - A3	Components of vector a for AOPT = 2.0
V1 - V3	Components of vector v for AOPT = 3.0
D1 - D3	Components of vector d for AOPT = 2.0

Remarks:

The Representative Volume Cell (RVC) approach is used in the micro-mechanical model development. The direction of the yarn in each sub-cell is determined by two angles – the braid angle, θ (the initial braid angle is 45 degrees), and the undulation angle of the yarn, which is different for the fill and warp-yarns, β_f and β_w (the initial undulations are normally a few degrees), respectively. The starting point for the homogenization of the material properties is the determination of the yarn stiffness matrices.

The elasticity tensor is given by

$$[C'] = [S']^{-1} = \begin{bmatrix} \frac{1}{E_1} & -\frac{\nu_{12}}{E_1} & -\frac{\nu_{12}}{E_1} & 0 & 0 & 0 \\ -\frac{\nu_{12}}{E_1} & \frac{1}{E_2} & -\frac{\nu_{23}}{E_2} & 0 & 0 & 0 \\ -\frac{\nu_{12}}{E_1} & -\frac{\nu_{23}}{E_2} & \frac{1}{E_2} & 0 & 0 & 0 \\ 0 & 0 & 0 & \frac{1}{\mu G_{12}} & 0 & 0 \\ 0 & 0 & 0 & 0 & \frac{1}{\mu G_{23}} & 0 \\ 0 & 0 & 0 & 0 & 0 & \frac{1}{\mu G_{12}} \end{bmatrix}^{-1}$$

where E_1 , E_2 , ν_{12} , ν_{23} , G_{12} and G_{23} are Young's moduli, Poisson's ratios, and the shear moduli of the yarn material, respectively. μ is a discount factor, which is function of the braid angle, θ , and has value between μ_0 and 1 as shown in the next figure. Initially, in a free stress state, the discount factor is a small value ($DSCF = \mu_0 \ll 1$) and the material has very small resistance to shear deformation if any.

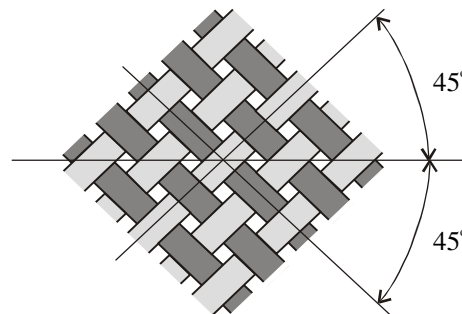

Plain Woven Fabric: Free State

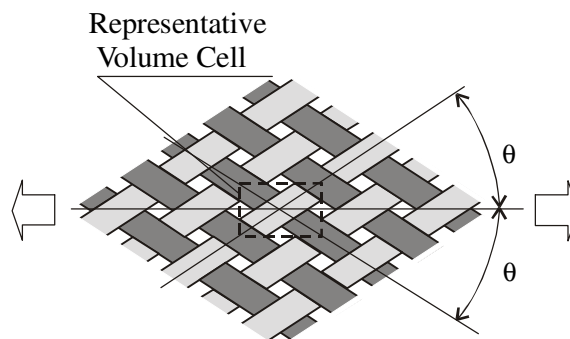

Plain Woven Fabric: Stretched

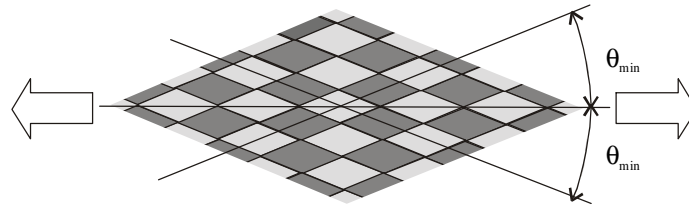

Plain Woven Fabric: Compacted

When locking occurs, the fabric yarns are packed and behave like elastic media. The discount factor is unity as shown in the next figure. The micro-mechanical model is developed to account for the reorientation of the yarns up to the locking angle. The locking angle, θ_{lock} , can be obtained from the yarn width and the spacing parameter of the fabric using simple geometrical relationship. The transition range, $\Delta\theta$ (angle tolerance for locking), can be chosen to be as small as possible, but big enough to prevent high frequency oscillations during the transition to the compacted state which depends on the range to the locking angle and the dynamics of the simulated problem. The reorientation damping constant damps some of the high frequency oscillations. A simple rate effect is added by defining the viscous modulus for normal or shear strain rate ($VME \times \dot{\epsilon}_{11}$ or 22 for normal components and $VMS \times \dot{\epsilon}_{12}$ for the shear components).

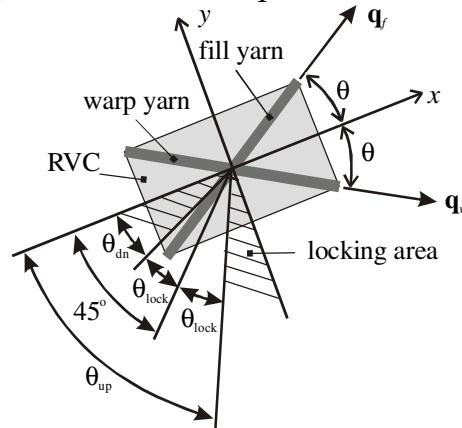

Locking Angles

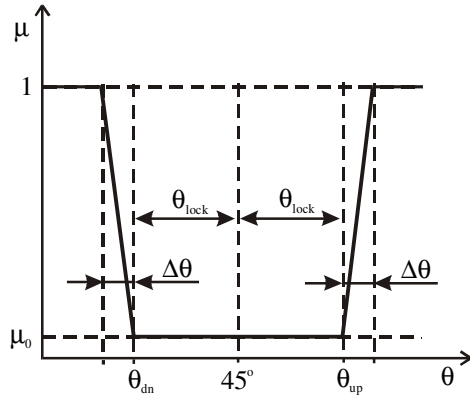

Discount factor as a function of braid angle, θ

***MAT_SCC_ON_RCC**

This is Material Type 236 developed by Carney, Lee, Goldberg, and Santhanam [2007]. This model simulates silicon carbide coating on Reinforced Carbon-Carbon (RCC), a ceramic matrix. It is based upon a quasi-orthotropic, linear-elastic, plane-stress model. Additional constitutive model attributes include a simple (meaning non-damage model based) option that can model the tension crack requirement: a “stress-cutoff” in tension. This option satisfies the tension crack requirements by limiting the stress in tension but not compression and having the tensile “yielding” (that is, the stress-cutoff) be fully recoverable – not plasticity or damage based.

Card 1	1	2	3	4	5	6	7	8
Variable	MID	RO	E0	E1	E2	E3	E4	E5
Type	A8	F	F	F	F	F	F	F

Card 2	1	2	3	4	5	6	7	8
Variable	PR	G	G_SCL	TSL	EPS_TAN			
Type	F	F	F	F	F			

VARIABLE**DESCRIPTION**

MID	Material identification. A unique number or label not exceeding 8 characters must be specified.
RO	Mass density
E0	E_0 ; see Remarks below.
E1	E_1 ; see Remarks below.
E2	E_2 ; see Remarks below.
E3	E_3 ; see Remarks below.
E4	E_4 ; see Remarks below.
E5	E_5 , Young’s modulus of the yarn in transverse-direction
PR	Poisson’s ratio

VARIABLE	DESCRIPTION
G	Shear modulus
G_SCL	Shear modulus multiplier (default = 1.0)
TSL	Tensile limit stress
EPS_TAN	Strain at which E = tangent to the polynomial curve

Remarks:

This model for the silicon carbide coating on RCC is based upon a quasi-orthotropic, linear-elastic, plane-stress model, given by:

$$\begin{Bmatrix} \sigma_1 \\ \sigma_2 \\ \tau_{12} \end{Bmatrix} = \begin{bmatrix} \frac{E}{1-\nu^2} & \frac{\nu E}{1-\nu^2} & 0 \\ \frac{\nu E}{1-\nu^2} & \frac{E}{1-\nu^2} & 0 \\ 0 & 0 & G_{12} \end{bmatrix} \begin{Bmatrix} \varepsilon_1 \\ \varepsilon_2 \\ \gamma_{12} \end{Bmatrix}$$

Additional constitutive model requirements include a simple (meaning non-damage model based) option that can model the tension crack requirement: a “stress-cutoff” in tension. This option satisfies the tension crack requirements by limiting the stress in tension but not compression and having the tensile “yielding” (that is, the stress-cutoff) be fully recoverable – not plasticity or damage based.

The tension stress-cutoff separately resets the stress to a limit value when it is exceeded in each of the two principal directions. There is also a strain-based memory criterion that ensures unloading follows the same path as loading: the “memory criterion” is the tension stress assuming that no stress cutoffs were in effect. In this way, when the memory criterion exceeds the user-specified cutoff stress, the actual stress will be set to that value. When the element unloads and the memory criterion falls back below the stress cutoff, normal behavior resumes. Using this criterion is a simple way to ensure that unloading does not result in any hysteresis. The cutoff criterion cannot be based on an effective stress value because effective stress does not discriminate between tension and compression while also including shear. This means that the in plane, 1- and 2- directions must be modeled as independent to use the stress cutoff. Because the Poisson’s ratio is not zero, this assumption is not true for cracks that may arbitrarily lie along any direction. However, careful examination of damaged RCC shows that the surface cracks do, generally, tend to lie in the fabric directions, meaning that cracks tend to open in the 1- or the 2- direction independently. So the assumption of directional independence for tension cracks may be appropriate for the coating because of this observed orthotropy.

The quasi-orthotropic, linear-elastic, plane-stress model with tension stress cutoff (to simulate tension cracks) can model the as-fabricated coating properties, which do not show

nonlinearities, but not the non-linear response of the flight-degraded material. Explicit finite element analysis (FEA) lends itself to *nonlinear-elastic* stress-strain relation instead of linear-elastic. Thus, instead of $\sigma = E\epsilon$, the modulus will be defined as a function of some effective strain quantity, or $\sigma = E(\epsilon_{\text{eff}})\epsilon$, even though it is uncertain, from the available data, whether the coating response is completely nonlinear-elastic and does not include some damage mechanism.

This nonlinear-elastic model cannot be implemented into a closed form solution or into an implicit solver; however, for explicit FEA such as is used for LS-DYNA impact analysis, the modulus can be adjusted at each time step to a higher or lower value as desired. In order to model the desired S-shape response curve of flight-degraded RCC coating, a function of strain that replicates the desired response must be found. The nonlinearities in the material are assumed recoverable (elastic) and the modulus is assumed to be communicative between the 1- and 2- directions (going against the tension-crack assumption that the two directions do not interact). Sometimes stability can be a problem for this type of nonlinearity modeling; however, stability was not found to be a problem with the material constants used for the coating.

The von Mises strain is selected for the effective strain definition as it couples the 3-dimensional loading but reduces to uniaxial data, so that the desired uniaxial compressive response can be reproduced. So,

$$\epsilon_{\text{eff}} = \frac{1}{\sqrt{2}} \frac{1}{1 + \nu} \sqrt{(\epsilon_1 - \epsilon_2)^2 + (\epsilon_2 - \epsilon_3)^2 + (\epsilon_1 - \epsilon_3)^2 + 3\gamma_{12}^2} ,$$

where for a two-dimensional, isotropic shell element case, the z-direction strain is given by:

$$\epsilon_3 = \frac{-\nu}{1 - \nu} (\epsilon_1 + \epsilon_2) .$$

The function for modulus is implemented as an arbitrary 5th order polynomial:

$$E(\epsilon_{\text{eff}}) = A_0\epsilon_{\text{eff}}^0 + A_1\epsilon_{\text{eff}}^1 + \dots + A_5\epsilon_{\text{eff}}^5 .$$

In the case of as-fabricated material the first coefficient, A_0 , is simply the modulus E , and the other coefficients, $A_{n>0}$, are zero, reducing to a 0th order polynomial, or linear. To match the degraded stress-strain compression curve, a higher order polynomial is needed. Six conditions on stress were used (stress and its derivative at beginning, middle, and end of the curve) to obtain a 5th order polynomial, and then the derivative of that equation was taken to obtain modulus as a function of strain, yielding a 4th order polynomial that represents the degraded coating modulus as strain curve.

For values of strain which exceed the failure strain observed in the laminate compression tests, the higher order polynomial will no longer match the test data. Therefore, after a specified effective-strain, representing failure, the modulus is defined to be the tangent of the polynomial curve. As a result, the stress/strain response has a continuous derivative, which aids in avoiding numerical instabilities. The test data does not clearly define

the failure strain of the coating, but in the impact test it appears that the coating has a higher compressive failure strain in bending than the laminate failure strain.

The two dominant modes of loading which cause coating loss on the impact side of the RCC (the front-side) are in-plane compression and transverse shear. The in-plane compression is measured by the peak out of plane tensile strain, ε_3 . As there is no direct loading of a shell element in this direction, ε_3 is computed through Poisson's relation:

$$\varepsilon_3 = \frac{-\nu}{1 - \nu} (\varepsilon_1 + \varepsilon_2) .$$

When ε_3 is tensile, it implies that the average of ε_1 and ε_2 is compressive. This failure mode will likely dominate when the RCC undergoes large bending, putting the front-side coating in high compressive strains. A transverse shear failure mode is expected to dominate when the debris source is very hard or very fast. By definition, the shell element cannot give a precise account of the transverse shear throughout the RCC's thickness. However, the Belytschko-Tsay shell element formulation in LS-DYNA has a first-order approximation of transverse shear that is based on the out-of-plane nodal displacements and rotations that should suffice to give a qualitative evaluation of the transverse shear. By this formulation, the transverse shear is constant through the entire shell thickness and thus violates surface-traction conditions. The constitutive model implementation records the peak value of the tensile out-of-plane strain (ε_3) and peak root-mean-sum transverse-shear: $\sqrt{\varepsilon_{13}^2 + \varepsilon_{23}^2}$.

***MAT_PML_HYSTERETIC**

This is Material Type 237. This is a perfectly-matched layer (PML) material with a Biot linear hysteretic constitutive law, to be used in a wave-absorbing layer adjacent to a Biot hysteretic material (*MAT_BIOT_HYSTERETIC) in order to simulate wave propagation in an unbounded medium with material damping. This material is the visco-elastic counterpart of the elastic PML material (*MAT_PML_ELASTIC). See the Remarks sections of *MAT_PML_ELASTIC (*MAT_230) and *MAT_BIOT_HYSTERETIC (*MAT_232) for further details.

Card	1	2	3	4	5	6	7	8
Variable	MID	RO	E	PR	ZT	FD		
Type	A8	F	F	F	F	F		
Default	none	none	none	none	0.0	3.25		

VARIABLE**DESCRIPTION**

MID	Material identification. A unique number or label not exceeding 8 characters must be specified.
RO	Mass density
E	Young's modulus
PR	Poisson's ratio
ZT	Damping ratio
FD	Dominant excitation frequency in Hz

***MAT_PERT_PIECEWISE_LINEAR_PLASTICITY**

This is Material Type 238. It is a duplicate of Material Type 24 (*MAT_PIECEWISE_LINEAR_PLASTICITY) modified for use with *PERTURBATION_MATERIAL and solid elements in an explicit analysis. It should give exactly the same values as the original material, if used exactly the same. It exists as a separate material type because of the speed penalty (an approximately 10% increase in the overall execution time) associated with the use of a material perturbation.

See Material Type 24 (*MAT_PIECEWISE_LINEAR_PLASTICITY) for a description of the material parameters. All of the documentation for Material Type 24 applies. First creating the input deck using Material Type 24 is recommended. Additionally, the CMP variable in the *PERTURBATION_MATERIAL must be set to affect a specific variables in the MAT_238 definition as defined in the following table; for example, CMP = 5 will perturb the yield stress.

CMP Value	Material Variable
3	E
5	SIGY
6	ETAN
7	FAIL

*MAT_240

*MAT_COHESIVE_MIXED_MODE_ELASTOPLASTIC_RATE

*MAT_COHESIVE_MIXED_MODE_ELASTOPLASTIC_RATE_{OPTION}

Available options include:

<BLANK>

THERMAL

3MODES

FUNCTIONS

This is Material Type 240. This model is a rate-dependent, elastic-ideally plastic cohesive zone model. It includes a tri-linear traction-separation law with a quadratic yield and damage initiation criterion in mixed-mode loading (mode I – mode II), while the damage evolution is governed by a power-law formulation. It can be used only with cohesive element formulations; see the variable ELFORM in *SECTION_SOLID and *SECTION_SHELL.

With the THERMAL option, some properties are defined as functions of temperature, meaning fields EMOD, GMOD, G1C_0, G2C_0, T0, S0, FG1, and FG2 must be defined as curve IDs instead of scalar values.

With the FUNCTIONS option, some properties are defined as functions of connection partner properties, meaning fields EMOD, GMOD, G1C_0, G2C_0, T0, S0, FG1, and FG2 must be defined as function IDs instead of scalar values. See remarks for details.

The keyword option 3MODES activates the possibility to include deformation/fracture mode III which could be useful for cohesive shells. Corresponding fields can be defined on optional Cards 4 and 5.

Note that 3MODES is compatible with THERMAL and FUNCTIONS, but THERMAL and FUNCTIONS cannot be used together. In other words, THERMAL_3MODES and FUNCTIONS_3MODES are allowed as keyword options, but THERMAL_FUNCTIONS is not allowed.

Card Summary:

Card 1. This card is required.

MID	RO	ROFLG	INTFAIL	EMOD	GMOD	THICK	INICRT
-----	----	-------	---------	------	------	-------	--------

Card 2. This card is required.

G1C_0	G1C_INF	EDOT_G1	T0	T1	EDOT_T	FG1	LCG1C
-------	---------	---------	----	----	--------	-----	-------

Card 3. This card is required.

G2C_0	G2C_INF	EDOT_G2	S0	S1	EDOT_S	FG2	LCG2C
-------	---------	---------	----	----	--------	-----	-------

Card 4. This card is included if the 3MODES keyword option is used.

G3C_0	G3C_INF	EDOT_G3	R0	R1	EDOT_R	FG3	LCG3C
-------	---------	---------	----	----	--------	-----	-------

Card 5. This card is included if the 3MODES keyword option is used.

GMOD3							
-------	--	--	--	--	--	--	--

Card 6. This card is optional.

RFILTF			XMU				
--------	--	--	-----	--	--	--	--

Data Card Definitions:

Card 1	1	2	3	4	5	6	7	8
Variable	MID	RO	ROFLG	INTFAIL	EMOD	GMOD	THICK	INICRT
Type	A	F	I	I	F/I	F/I	F	F

VARIABLE

DESCRIPTION

MID	Material identification. A unique number or label must be specified (see *PART).
RO	Mass density
ROFLG	Flag for whether density is specified per unit area or volume: EQ.0: Specified density per unit volume (default) EQ.1: Specifies the density is per unit area for controlling the mass of cohesive elements with an initial volume of zero
INTFAIL	Number of integration points required for the cohesive element to be deleted. The value of INTFAIL may range from 1 to 4 with 1 the recommended value. LT.0.0: Employs a Newton-Cotes integration scheme. The element will be deleted when INTFAIL integration points have failed.

VARIABLE	DESCRIPTION
	EQ.0.0: Employs a Newton-Cotes integration scheme. The element will <i>not</i> be deleted even if it satisfies the failure criterion.
	GT.0.0: Employs a Gauss integration scheme. The element will be deleted when INTFAIL integration points have failed.
EMOD	Young's modulus of the material (Mode I). It is a curve ID if the THERMAL keyword option is used. It is a function ID if the FUNCTIONS keyword option is used.
GMOD	The shear modulus of the material (Mode II). Curve ID for THERMAL keyword option. GMOD is a function ID for the FUNCTIONS keyword option.
THICK	GT.0.0: Cohesive thickness LE.0.0: Initial thickness is calculated from nodal coordinates.
INICRT	Yield and damage initiation criterion: EQ.0.0: Quadratic nominal stress (default) EQ.1.0: Maximum nominal stress EQ.2.0: Maximum nominal stress (same as INICRT = 1.0). Additionally, it flags outputting the maximum strain as history variable #15. LT.0.0: Mixed mode with flexible exponent INICRT

Card 2	1	2	3	4	5	6	7	8
Variable	G1C_0	G1C_INF	EDOT_G1	T0	T1	EDOT_T	FG1	LCG1C
Type	F/I	F	F	F/I	F	F	F/I	I

VARIABLE	DESCRIPTION
G1C_0	GT.0.0: Energy release rate G_{IC} in Mode I. G1C_0 is a curve ID if the THERMAL keyword option is used. G1C_0 is a function ID if the FUNCTIONS keyword option is used. LE.0.0: Lower bound value of rate-dependent G_{IC}

VARIABLE	DESCRIPTION
G1C_INF	Upper bound value of rate-dependent G_{IC} (only considered if $G1C_0 < 0$)
EDOT_G1	Equivalent strain rate at yield initiation to describe the rate dependency of G_{IC} (only considered if $G1C_0 < 0$)
T0	<p>GT.0.0: Yield stress in Mode I. T0 is a curve ID if the THERMAL keyword option is used. T0 is a function ID if the FUNCTIONS keyword option is used.</p> <p>LT.0.0: Rate-dependency is considered; see T1 and EDOT_T.</p>
T1	<p>Field T1, only considered if $T0 < 0$:</p> <p>GT.0.0: Quadratic logarithmic model</p> <p>LT.0.0: Linear logarithmic model</p>
EDOT_T	Equivalent strain rate at yield initiation to describe the rate dependency of the yield stress in Mode I (only considered if $T0 < 0$)
FG1	<p>f_{G1}, describes the tri-linear shape of the traction-separation law in Mode I. See remarks. It is a curve ID if the THERMAL keyword option is used. It is a function ID if the FUNCTIONS keyword option is used.</p> <p>GT.0.0: FG1 is the ratio of fracture energies, $G_{I,P}/G_{IC}$.</p> <p>LT.0.0: FG1 is ratio of displacements, $(\delta_{n2} - \delta_{n1})/(\delta_{nf} - \delta_{n1})$.</p>
LCG1C	Load curve ID which defines fracture energy GIC as a function of cohesive element thickness. G1C_0 and G1C_INF are ignored in this case.

Card 3	1	2	3	4	5	6	7	8
Variable	G2C_0	G2C_INF	EDOT_G2	S0	S1	EDOT_S	FG2	LCG2C
Type	F/I	F	F	F/I	F	F	F/I	I

VARIABLE	DESCRIPTION
G2C_0	<p>GT.0.0: Energy release rate G_{IIC} in Mode II. If the THERMAL keyword option is used, it is a load curve ID. For the FUNCTIONS keyword option, it is a function ID.</p> <p>LE.0.0: Lower bound value of rate-dependent G_{IIC}</p>
G2C_INF	Upper bound value of G_{IIC} (only considered if $G2C_0 < 0$)
EDOT_G2	Equivalent strain rate at yield initiation to describe the rate dependency of G_{IIC} (only considered if $G2C_0 < 0$)
S0	<p>GT.0.0: Yield stress in Mode II. It is a load curve ID for the THERMAL keyword option. It is a function ID for the FUNCTIONS keyword option.</p> <p>LT.0.0: Rate-dependency is considered; see S1 and EDOT_S</p>
S1	<p>Parameter S1, only considered if $S0 < 0$:</p> <p>GT.0.0: Quadratic logarithmic model is applied.</p> <p>LT.0.0: Linear logarithmic model is applied.</p>
EDOT_S	Equivalent strain rate at yield initiation to describe the rate dependency of the yield stress in Mode II (only considered if $S0 < 0$)
FG2	<p>f_{G2}, describes the tri-linear shape of the traction-separation law in Mode II, see remarks. It is a load curve ID for the THERMAL keyword option. It is a function ID for the FUNCTIONS keyword option.</p> <p>GT.0.0: FG2 is the ratio of fracture energies, $G_{II,P}/G_{IIC}$.</p> <p>LT.0.0: $FG2$ is the ratio of displacements, $(\delta_{t2} - \delta_{t1})/(\delta_{tf} - \delta_{t1})$.</p>
LCG2C	Load curve ID which defines fracture energy G_{IIC} as a function of cohesive element thickness. $G2C_0$ and $G2C_INF$ are ignored in that case.

Additional Cards 4 and 5 for 3MODES keyword option. Properties for Mode III (out-of-plane mode in cohesive shell elements).

Card 4	1	2	3	4	5	6	7	8
Variable	G3C_0	G3C_INF	EDOT_G3	R0	R1	EDOT_R	FG3	LCG3C
Type	F/I	F	F	F/I	F	F	F/I	I

Card 5	1	2	3	4	5	6	7	8
Variable	GMOD3							
Type	F/I							

VARIABLE	DESCRIPTION
G3C_0	<p>GT.0.0: Energy release rate G_{III} in Mode III. G3C_0 is a load curve ID for the THERMAL keyword option. G3C_0 is a function ID for the FUNCTIONS keyword option.</p> <p>LE.0.0: Lower bound value of rate-dependent G_{III}</p>
G3C_INF	Upper bound value of rate-dependent G_{III} (only considered if $G3C_0 < 0$)
EDOT_G3	Equivalent strain rate at yield initiation to describe the rate dependency of G_{III} (only considered if $G1C_0 < 0$)
R0	<p>GT.0.0: Yield stress in Mode III. R0 is a load curve ID for the THERMAL keyword option. R0 is a function ID for the FUNCTIONS keyword option.</p> <p>LT.0.0: Rate-dependency is considered</p>
R1	<p>Parameter R1, only considered if $R0 < 0$:</p> <p>GT.0.0: Quadratic logarithmic model</p> <p>LT.0.0: Linear logarithmic model</p>
EDOT_R	Equivalent strain rate at yield initiation to describe the rate dependency of the yield stress in Mode III (only considered if $R0 < 0$)

VARIABLE	DESCRIPTION
FG3	<p>f_{G3}, describes the tri-linear shape of the traction-separation law in Mode III; see remarks. It is a load curve ID if the THERMAL keyword option is used. It is a function ID if the FUNCTIONS keyword option is used.</p> <p>GT.0.0: FG3 is ratio of fracture energies, $G_{III,P}/G_{III,C}$.</p> <p>LT.0.0: FG3 is ratio of displacements, $(\delta_{s2} - \delta_{s1})/(\delta_{sf} - \delta_{s1})$.</p>
LCG3C	Load curve ID which defines fracture energy GIII C as a function of cohesive element thickness. G3C_0 and G3C_INF are ignored in that case.
GMOD3	Shear modulus for Mode III. GMOD3 is a load curve ID for the THERMAL keyword option. GMOD3 is a function ID for the FUNCTIONS keyword option.

This card is optional.

Card 6	1	2	3	4	5	6	7	8
Variable	RFILTF			XMU				
Type	F			F				

VARIABLE	DESCRIPTION
RFILTF	<p>Smoothing factor on the equivalent strain rate using an exponential moving average method:</p> $\dot{\epsilon}_n^{\text{avg}} = \text{RFILTF} \times \dot{\epsilon}_{n-1}^{\text{avg}} + (1 - \text{RFILTF}) \times \dot{\epsilon}_n$ <p>This option invokes a modified handling of strain rates (see Remarks).</p> <p>GT.0.0: RFILTF applied on the equivalent plastic strain rate.</p> <p>LT.0.0: RFILTF applied on the equivalent total strain rate.</p>
XMU	Exponent of the mixed mode failure criterion. Default is 1.0.

Remarks:

The model is a tri-linear elastic-ideally plastic Cohesive Zone Model, developed by Marzi et al. [2009]. It looks similar to *MAT_185 but considers effects of plasticity and rate-

dependency. Since the entire separation at failure is plastic, no brittle fracture behavior can be modeled with this material type.

The following description of the model is for two deformation/fracture modes (I and II) only, meaning without the option 3MODES. This is a natural choice for cohesive solid elements, where no specific distinction between in-plane and out-of-plane shear can be made. On the other hand, if this material model is used with the cohesive shell element type ± 29 , shear deformation can clearly be separated into in-plane shear (Mode II) and out-of-plane shear (Mode III). This can be taken into account by adding 3MODES to the keyword and defining additional Cards 4 and 5. Corresponding equations including Mode III are not explicitly given here (for the sake of brevity), but derivation of them is straightforward.

The separations, Δ_n and Δ_t , in the normal (peel) and tangential (shear) directions, respectively, are calculated from the element's separations in the integration points,

$$\Delta_n = \max(u_n, 0)$$

and

$$\Delta_t = \sqrt{u_{t1}^2 + u_{t2}^2} .$$

u_n is the separation in the normal direction while u_{t1} and u_{t2} is the separation in both tangential directions of the element coordinate system. The total (mixed-mode) separation Δ_m is determined by

$$\Delta_m = \sqrt{\Delta_n^2 + \Delta_t^2} .$$

The initial stiffnesses in both modes are calculated from the elastic Young's and shear moduli and are respectively,

$$E_n = \frac{\text{EMOD}}{\text{THICK}}$$

$$E_t = \frac{\text{GMOD}}{\text{THICK}} ,$$

where THICK, the element's thickness, is an input parameter. If $\text{THICK} \leq 0$, it is calculated from the distance between the initial positions of the element's corner nodes (Nodes 1-5, 2-6, 3-7 and 4-8, respectively).

While the total energy under the traction-separation law is given by G_C , one further parameter is needed to describe the exact shape of the tri-linear material model. If the area (energy) under the constant stress (plateau) region is denoted G_P (see [Figure M240-1](#)), a parameter f_G defines the shape of the traction-separation law,

$$0 \leq f_{G1} = \frac{G_{I,P}}{G_{IC}} < 1 - \frac{T^2}{2G_{IC}E_n} < 1 \quad \text{for mode I loading}$$

$$0 \leq f_{G2} = \frac{G_{II,P}}{G_{IIC}} < 1 - \frac{S^2}{2G_{IIC}E_t} < 1 \quad \text{for mode II loading}$$

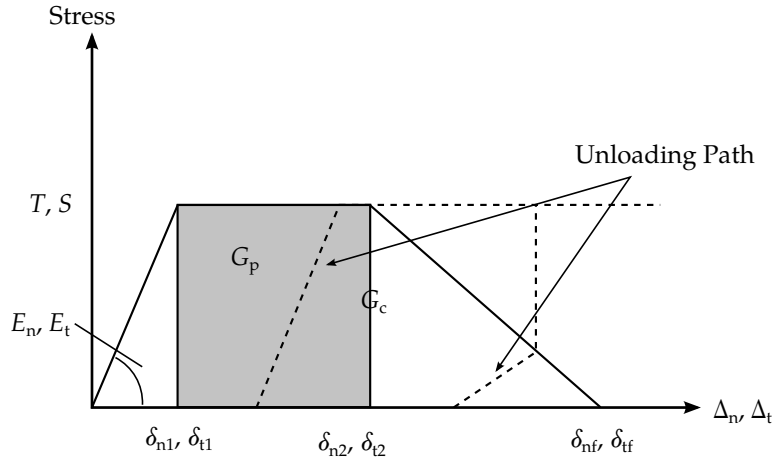

Figure M240-1. Trilinear traction separation law

As a recommended alternative, the shape of the tri-linear model can be described by the following displacement ratios (triggered by negative input values for f_G):

$$0 < |f_{G1}| = \left| \frac{\delta_{n2} - \delta_{n1}}{\delta_{nf} - \delta_{n1}} \right| < 1 \quad \text{for mode I loading}$$

$$0 < |f_{G2}| = \left| \frac{\delta_{t2} - \delta_{t1}}{\delta_{tf} - \delta_{t1}} \right| < 1 \quad \text{for mode II loading}$$

While f_{G1} and f_{G2} are always constant values, T , S , G_{IC} , and G_{IIC} may be chosen as functions of an equivalent strain rate $\dot{\epsilon}_{eq}$ which is evaluated by

$$\dot{\epsilon}_{eq} = \frac{\sqrt{\dot{u}_n^2 + \dot{u}_{t1}^2 + \dot{u}_{t2}^2}}{\text{THICK}}$$

Here \dot{u}_n , \dot{u}_{t1} , and \dot{u}_{t2} are the velocities corresponding to the separations u_n , u_{t1} , and u_{t2} , respectively.

For the yield stresses, two rate dependent formulations are implemented:

1. A quadratic logarithmic function:

$$T(\dot{\epsilon}_{eq}) = |T0| + |T1| \left[\max \left(0, \ln \frac{\dot{\epsilon}_{eq}}{\text{EDOT}_T} \right) \right]^2 \quad \text{for mode I if } T0 < 0 \text{ and } T1 > 0$$

$$S(\dot{\epsilon}_{eq}) = |S0| + |S1| \left[\max \left(0, \ln \frac{\dot{\epsilon}_{eq}}{\text{EDOT}_S} \right) \right]^2 \quad \text{for mode II if } S0 < 0 \text{ and } S1 > 0$$

2. A linear logarithmic function:

$$T(\dot{\epsilon}_{eq}) = |T0| + |T1| \max \left(0, \ln \frac{\dot{\epsilon}_{eq}}{\text{EDOT}_T} \right) \quad \text{for mode I if } T0 < 0 \text{ and } T1 < 0$$

$$S(\dot{\epsilon}_{eq}) = |S0| + |S1| \max \left(0, \ln \frac{\dot{\epsilon}_{eq}}{\text{EDOT}_S} \right) \quad \text{for mode II if } S0 < 0 \text{ and } S1 < 0$$

Alternatively, T and S can be set to constant values:

$$\begin{aligned} T(\dot{\epsilon}_{eq}) &= T0 \quad \text{for mode I if } T0 > 0 \\ S(\dot{\epsilon}_{eq}) &= S0 \quad \text{for mode II if } S0 > 0 \end{aligned}$$

The rate-dependency of the fracture energies are given by:

$$\begin{aligned} G_{IC}(\dot{\epsilon}_{eq}) &= |G1C_0| + (G1C_INF - |G1C_0|) \exp\left(-\frac{EDOT_G1}{\dot{\epsilon}_{eq}}\right) \quad \text{if } G1C_0 < 0 \\ G_{IIC}(\dot{\epsilon}_{eq}) &= |G2C_0| + (G2C_INF - |G2C_0|) \exp\left(-\frac{EDOT_G2}{\dot{\epsilon}_{eq}}\right) \quad \text{if } G2C_0 < 0 \end{aligned}$$

If positive values are chosen for $G1C_0$ or $G2C_0$, no rate-dependency is considered for this parameter and its value remains constant as specified by the user.

As an alternative, fracture energies G_{IC} and G_{IIC} can be defined as functions of cohesive element thickness by using load curves $LCG1C$ and $LCG2C$, respectively. In that case, parameters $G1C_0$, $G1C_INF$, $G2C_0$, and $G2C_INF$ will be ignored, and no rate dependence is considered.

Note that the equivalent strain rate $\dot{\epsilon}_{eq}$ is updated until $\Delta_m > \delta_{m1}$. Then, the model behavior depends on the equivalent strain rate at yield initiation. A modified handling of strain rates is invoked by $RFILTF \neq 0$ with which filtered strain rates are updated throughout the whole process.

Having defined the parameters describing the single modes, the mixed-mode behavior is formulated by quadratic initiation criteria for both yield stress and damage initiation, while the damage evolution follows a Power-Law. Due to reasons of readability, the following simplifications are made,

$$\begin{aligned} T &= T(\dot{\epsilon}_{eq}) \\ S &= S(\dot{\epsilon}_{eq}) \\ G_{IC} &= G_{IC}(\dot{\epsilon}_{eq}) \\ G_{IIC} &= G_{IIC}(\dot{\epsilon}_{eq}) \end{aligned}$$

If the quadratic nominal stress criterion is used ($INICRT = 0$), the mixed-mode yield initiation displacement δ_{m1} is defined as

$$\delta_{m1} = \delta_{n1} \delta_{t1} \sqrt{\frac{1 + \beta^2}{\delta_{t1}^2 + (\beta \delta_{n1})^2}},$$

where $\delta_{n1} = T/E_n$ and $\delta_{t1} = S/E_t$ are the single-mode yield initiation displacements and $\beta = \Delta_t/\Delta_n$ is the mixed-mode ratio. As an analog to the yield initiation, the damage initiation displacement δ_{m2} is defined as:

$$\delta_{m2} = \delta_{n2} \delta_{t2} \sqrt{\frac{1 + \beta^2}{\delta_{t2}^2 + (\beta \delta_{n2})^2}},$$

where

$$\delta_{n2} = \delta_{n1} + \frac{f_{G1} G_{IC}}{T}$$

$$\delta_{t2} = \delta_{t1} + \frac{f_{G2} G_{IIC}}{S}$$

As an alternative, a maximum nominal stress criterion could be used (INICRT = 1) which results in the following expressions for yield and damage initiation displacements:

$$\delta_{m1} = \begin{cases} \delta_{n1} \sqrt{1 + \beta^2} & \text{if } \beta \leq \frac{\delta_{t1}}{\delta_{n1}} \\ \frac{\delta_{t1}}{\beta} \sqrt{1 + \beta^2} & \text{if } \beta > \frac{\delta_{t1}}{\delta_{n1}} \end{cases}$$

$$\delta_{m2} = \begin{cases} \delta_{n2} \sqrt{1 + \beta^2} & \text{if } \beta \leq \frac{\delta_{t2}}{\delta_{n2}} \\ \frac{\delta_{t2}}{\beta} \sqrt{1 + \beta^2} & \text{if } \beta > \frac{\delta_{t2}}{\delta_{n2}} \end{cases}$$

A third possibility is to choose INICRT < 0, which invokes a nominal stress criterion with flexible exponent:

$$\delta_{m1} = \delta_{n1} \delta_{t1} \sqrt{1 + \beta^2} (\delta_{t1}^{|\text{INICRT}|} + (\beta \delta_{n1})^{|\text{INICRT}|})^{-1/|\text{INICRT}|}$$

$$\delta_{m2} = \delta_{n2} \delta_{t2} \sqrt{1 + \beta^2} (\delta_{t2}^{|\text{INICRT}|} + (\beta \delta_{n2})^{|\text{INICRT}|})^{-1/|\text{INICRT}|}$$

Obviously, the special case of INICRT = -2 would lead to the same result as the quadratic criterion, INICRT = 0.

With $\gamma = \arccos\left(\frac{u_n}{\Delta_m}\right)$, the ultimate (failure) displacement δ_{mf} can be written,

$$\delta_{mf} = \frac{\delta_{m1} (\delta_{m1} - \delta_{m2}) E_n G_{IIC} \cos^2 \gamma + G_{IC} (2G_{IIC} + \delta_{m1} (\delta_{m1} - \delta_{m2}) E_t \sin^2 \gamma)}{\delta_{m1} (E_n G_{IIC} \cos^2 \gamma + E_t G_{IC} \sin^2 \gamma)}.$$

This formulation describes a power-law damage evolution with an exponent $\eta = 1.0$ (see *MAT_138). This is the case for XMU = 0.0 or 1.0.

With the definition of an arbitrary value for XMU, the failure displacement is given by

$$\delta_{mf} = \max \left(\delta_{m2}, \delta_{m1} - \delta_{m2} + \frac{2}{\delta_{m1}} \left[\left(\frac{E_n \cos^2 \gamma}{G_{IC}} \right)^{\text{XMU}} + \left(\frac{E_t \sin^2 \gamma}{G_{IIC}} \right)^{\text{XMU}} \right]^{-1/\text{XMU}} \right)$$

After the shape of the mixed-mode traction-separation law has been determined by δ_{m1} , δ_{m2} , and δ_{mf} , the plastic separation in each element direction, $u_{n,P}$, $u_{t1,P}$, and $u_{t2,P}$ can be calculated. The plastic separation in peel direction is given by

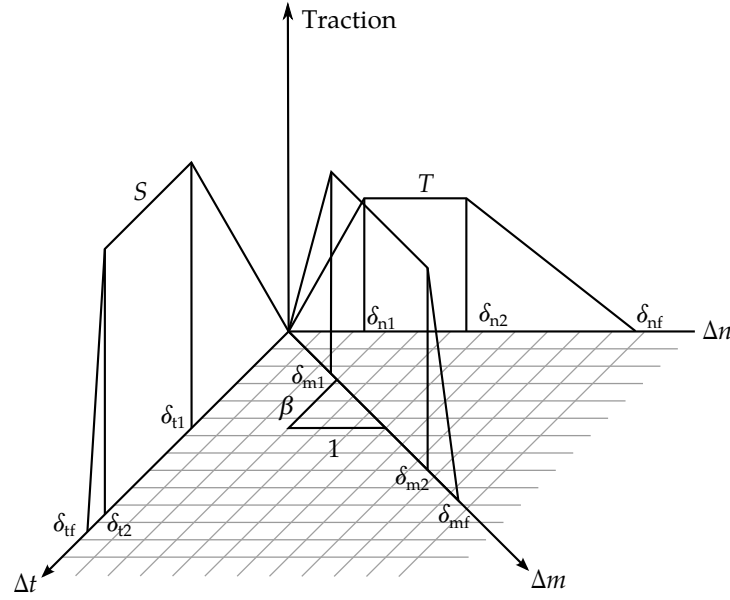

Figure M240-2. Trilinear mixed mode traction-separation law

$$u_{n,P} = \max(u_{n,P,\Delta t-1}, u_n - \delta_{m1} \cos(\gamma), 0) .$$

In the shear direction, a shear yield separation $\delta_{t,y}$,

$$\delta_{t,y} = \sqrt{(u_{t1} - u_{t1,P,\Delta t-1})^2 + (u_{t2} - u_{t2,P,\Delta t-1})^2},$$

is defined. If $\delta_{t,y} > \delta_{m1} \sin \gamma$, the plastic shear separations in the element coordinate system are updated,

$$u_{t1,P} = u_{t1,P,\Delta t-1} + u_{t1} - u_{t1,\Delta t-1}$$

$$u_{t2,P} = u_{t2,P,\Delta t-1} + u_{t2} - u_{t2,\Delta t-1}$$

In the formulas above, $\Delta t - 1$ indicates the individual value from the last time increment. In case $\Delta_m > \delta_{m2}$, the damage initiation criterion is satisfied and a damage variable D increases monotonically,

$$D = \max\left(\frac{\Delta_m - \delta_{m2}}{\delta_{mf} - \delta_{m2}}, D_{\Delta t-1}, 0\right) .$$

When $\Delta_m > \delta_{mf}$, complete damage ($D = 1$) is reached and the element fails in the corresponding integration point.

Finally, the peel and the shear stresses in element directions are calculated,

$$\sigma_{t1} = E_t(1 - D)(u_{t1} - u_{t1,P})$$

$$\sigma_{t2} = E_t(1 - D)(u_{t2} - u_{t2,P})$$

In the peel direction, no damage under pressure loads is considered if $u_n - u_{n,P} > 0$

$$\sigma_n = E_n(u_n - u_{n,P}) .$$

Otherwise,

$$\sigma_n = E_n(1 - D)(u_n - u_{n,P}) .$$

If the FUNCTIONS keyword option is used, parameters EMOD, GMOD, G1C_0, G2C_0, T0, S0, FG1, and FG2 (as well as GMOD3, G3C_0, R0, and FG3 if combined with 3MODES) should refer to *DEFINE_FUNCTION IDs. The arguments of those functions include several properties of both connection partners if corresponding solid elements are in a tied contact with shell elements.

These functions depend on:

- (t1, t2) = thicknesses of both bond partners
- (sy1, sy2) = initial yield stresses at plastic strain of 0.002
- (sm1, sm2) = maximum engineering yield stresses (necking points)
- r = strain rate
- a = element area
- (e1, e2) = Young's moduli

For T0 = -100 such a function could look like:

```
*DEFINE_FUNCTION
      100
      func (t1, t2, sy1, sy2, sm1, sm2, r, a, e1, e2) = 0.5 * (sy1 + sy2)
```

Since material parameters must be identified from both bond partners during initialization, this feature is only available for a subset of material models at the moment, namely material models 24, 36, 120, 123, 124, 251, and 258.

Reference:

S. Marzi, O. Hesebeck, M. Brede and F. Kleiner (2009), A Rate-Dependent, Elasto-Plastic Cohesive Zone Mixed-Mode Model for Crash Analysis of Adhesively Bonded Joints, In Proceeding: 7th European LS-DYNA Conference, Salzburg

***MAT_JOHNSON_HOLMQUIST_JH1**

This is Material Type 241. This Johnson-Holmquist Plasticity Damage Model is useful for modeling ceramics, glass and other brittle materials. This version corresponds to the original version of the model, JH1, and Material Type 110 corresponds to JH2, the updated model.

Card 1	1	2	3	4	5	6	7	8
Variable	MID	RO	G	P1	S1	P2	S2	C
Type	A	F	F	F	F	F	F	F

Card 2	1	2	3	4	5	6	7	8
Variable	EPS0	T		ALPHA	SFMAX	BETA	DP1	
Type	F	F		F	F	F	F	

Card 3	1	2	3	4	5	6	7	8
Variable	EPFMIN	EPFMAX	K1	K2	K3	FS	FDAM	
Type	F	F	F	F	F	F	F	

VARIABLE**DESCRIPTION**

MID	Material identification. A unique number or label must be specified (see *PART).
RO	Density
G	Shear modulus
P1	Pressure point 1 for intact material
S1	Effective stress at P1
P2	Pressure point 2 for intact material
S2	Effective stress at P2

VARIABLE	DESCRIPTION
C	Strain rate sensitivity factor
EPS0	Quasi-static threshold strain rate. See *MAT_015.
T	Maximum tensile pressure strength. This value is positive in tension.
ALPHA	Initial slope of the fractured material strength curve. See Figure M241-1 .
SFMAX	Maximum strength of the fractured material
BETA	Fraction of elastic energy loss converted to hydrostatic energy (affects bulking pressure (history variable 1) that accompanies damage).
DP1	Maximum compressive pressure strength. This value is positive in compression.
EPFMIN	Plastic strain for fracture at tensile pressure T . See Figure M241-2 .
EPFMAX	Plastic strain for fracture at compressive pressure $DP1$. See Figure M241-1 .
K1	First pressure coefficient (equivalent to the bulk modulus).
K2	Second pressure coefficient
K3	Third pressure coefficient
FS	Element deletion due to hydrostatic pressure or equivalent plastic strain: LT.0.0: Delete if $P < FS$ (tensile failure) EQ.0.0: No element deletion (default) GT.0.0: Delete element if the $\bar{\epsilon}^p > FS$
FDAM	Failure damage value. If this damage value is reached, the element is deleted. A meaningful value would be $FDAM = 1.0$, for instance. EQ.0.0: No element deletion due to damage (default)

Remarks:

The equivalent stress for both intact and fractured ceramic-type materials is given by

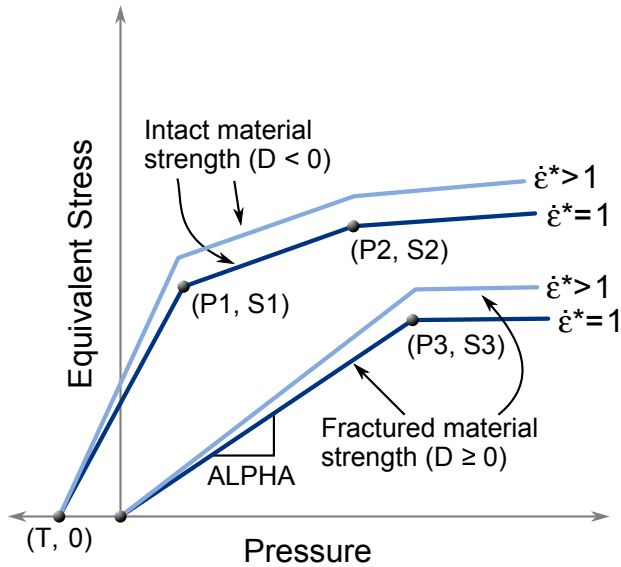

Figure M241-1. Strength: equivalent stress versus pressure.

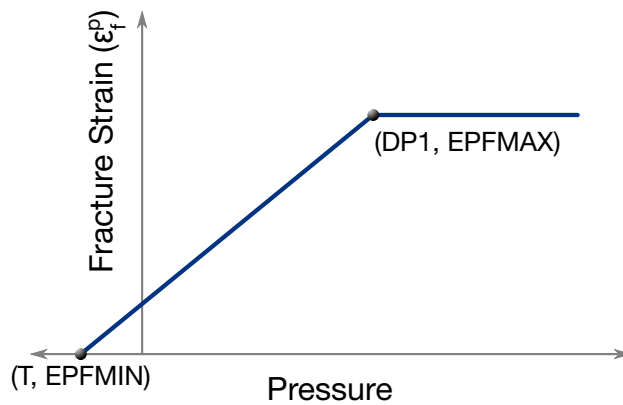

Figure M241-2. Fracture strain versus pressure.

$$\sigma_y = (1 + c \ln \dot{\epsilon}^*) \sigma(P)$$

where $\sigma(P)$ is evaluated according to [Figure M241-1](#).

$$D = \sum \Delta \epsilon^p / \epsilon_f^p(P)$$

represents the accumulated damage (history variable 2) based upon the increase in plastic strain per computational cycle and the plastic strain to fracture is evaluated according to [Figure M241-2](#).

In undamaged material, the hydrostatic pressure is given by

$$P = k_1 \mu + k_2 \mu^2 + k_3 \mu^3 + \Delta P$$

in compression and by

$$P = k_1 \mu + \Delta P$$

in tension where $\mu = \rho/\rho_0 - 1$. A fraction, between 0 and 1, of the elastic energy loss, β , is converted into hydrostatic potential energy (pressure). The pressure increment, ΔP , associated with the increment in the hydrostatic potential energy is calculated at fracture, where σ_y and σ_y^f are the intact and failed yield stresses respectively. This pressure increment is applied in both compression and tension, which is not true for JH2 where the increment is added only in compression.

$$\Delta P = -k_1\mu_f + \sqrt{(k_1\mu_f)^2 + 2\beta k_1\Delta U}$$
$$\Delta U = \frac{\sigma_y - \sigma_y^f}{6G}$$

*MAT_KINEMATIC_HARDENING_BARLAT2000

This is Material Type 242. This model combines the Yoshida non-linear kinematic hardening rule (*MAT_125) with the 8-parameter material model (*MAT_133) of Barlat et al. (2003) to model metal sheets under cyclic plasticity loading with anisotropy in plane stress conditions (see also *MAT_226). This material is available only for shell elements.

Card Summary:

Card 1. This card is required.

MID	RO	E	PR	EA	COE	M	
-----	----	---	----	----	-----	---	--

Card 2. This card is required.

ALPHA1	ALPHA2	ALPHA3	ALPHA4	ALPHA5	ALPHA6	ALPHA7	ALPHA8
--------	--------	--------	--------	--------	--------	--------	--------

Card 3. This card must be included as a blank card.

--	--	--	--	--	--	--	--

Card 4. This card must be included as a blank card.

--	--	--	--	--	--	--	--

Card 5. This card is required.

CB	Y	SC1	K	RSAT	SB	H	SC2
----	---	-----	---	------	----	---	-----

Card 6. This card is required.

AOPT		IOPT	C1	C2			
------	--	------	----	----	--	--	--

Card 7. This card is required.

			A1	A2	A3		
--	--	--	----	----	----	--	--

Card 8. This card is required.

V1	V2	V3	D1	D2	D3		
----	----	----	----	----	----	--	--

Data Card Definitions:

Card 1	1	2	3	4	5	6	7	8
Variable	MID	RO	E	PR	EA	COE	M	
Type	A	F	F	F	F	F	F	
Default	none	0.0	0.0	0.0	0.0	0.0	none	

VARIABLE**DESCRIPTION**

MID	Material identification. A unique number or label must be specified (see *PART).
RO	Mass density
E	Young's modulus, E
PR	Poisson's ratio, ν
EA	E^A , parameter controlling the change of Young's modulus; see the remarks of *MAT_125. LT.0.0: EA is a curve ID giving the change of Young's modulus as a function of effective plastic strain.
COE	ζ , parameter controlling the change of Young's modulus; see the remarks of *MAT_125.
M	Flow potential exponent. For face centered cubic (FCC) materials $m = 8$ is recommended and for body centered cubic (BCC) materials $m = 6$ may be used. LT.0.0: M is a load curve ID specifying the flow potential exponent as a function of effective plastic strain.

Card 2	1	2	3	4	5	6	7	8
Variable	ALPHA1	ALPHA2	ALPHA3	ALPHA4	ALPHA5	ALPHA6	ALPHA7	ALPHA8
Type	F	F	F	F	F	F	F	F
Default	0.0	0.0	0.0	0.0	0.0	0.0	0.0	0.0

VARIABLE

DESCRIPTION

ALPHA_{*i*}

α_i , material constants in Barlat's yield equation

LT.0.0: |ALPHA_{*i*}| is a load curve ID specifying α_i as a function of effective plastic strain.

Card 3	1	2	3	4	5	6	7	8
Variable								
Type								
Default								

Card 4	1	2	3	4	5	6	7	8
Variable								
Type								
Default								

Card 5	1	2	3	4	5	6	7	8
Variable	CB	Y	SC1	K	RSAT	SB	H	SC2
Type	F	F	F	F	F	F	F	F
Default	none	none	none	none	none	none	none	0.0

VARIABLE**DESCRIPTION**

CB

The uppercase B defined in Yoshida's equations.

Y

Anisotropic parameter associated with work-hardening stagnation, defined in Yoshida's equations

SC1

The lowercase c_2 defined in Yoshida & Uemori's equations. Note the equation below from the paper:

$$c = \begin{cases} c_1 & \max(\bar{\alpha}_*) < B - Y \\ c_2 & \text{otherwise} \end{cases}$$

See more details in [About SC1 and SC2](#) in the remarks section of *MAT_125.

K

Hardening parameter as defined in Yoshida's equations

RSAT

Hardening parameter as defined in Yoshida's equations

SB

The lowercase b as defined in Yoshida's equations

H

Anisotropic parameter associated with work-hardening stagnation, defined in Yoshida's equations

SC2

The lowercase c_1 defined in the Yoshida and Uemori's equations. Note the equation below from the paper:

$$c = \begin{cases} c_1 & \max(\bar{\alpha}_*) < B - Y \\ c_2 & \text{otherwise} \end{cases}$$

See more details in [About SC1 and SC2](#) in the remarks section of *MAT_125. If SC2 equals 0.0, is left blank, or equals SC1, then it turns into the basic model (the one c model).

Card 6	1	2	3	4	5	6	7	8
Variable	AOPT		IOPT	C1	C2			
Type	I		I	F	F			
Default	none		none	0.0	0.0			

VARIABLE**DESCRIPTION**

AOPT

Material axes option (see *MAT_OPTIONTROPIC_ELASTIC* for a more complete description). Note AOPT may need to set to 0.0 for a simulation using the dynain file from a previous simulation.

EQ.0.0: Locally orthotropic with material axes determined by element nodes 1, 2, and 4, as with *DEFINE_COORDINATE_NODES

EQ.2.0: Globally orthotropic with material axes determined by vectors defined below, as with *DEFINE_COORDINATE_VECTOR

EQ.3.0: Locally orthotropic material axes determined by rotating the material axes about the element normal by an angle, BETA, from a line in the plane of the element defined by the cross product of the vector \mathbf{v} with the element normal

LT.0.0: The absolute value of AOPT is a coordinate system ID number (CID on *DEFINE_COORDINATE_NODES, *DEFINE_COORDINATE_SYSTEM or *DEFINE_COORDINATE_VECTOR).

IOPT

Kinematic hardening rule flag:

EQ.0: Original Yoshida formulation

EQ.1: Modified formulation. Define C1, C2 below.

C1, C2

Constants used to modify R :

$$R = \text{RSAT} \times [(C_1 + \bar{\epsilon}^p)^{c_2} - C_1^{c_2}]$$

Card 7	1	2	3	4	5	6	7	8
Variable				A1	A2	A3		
Type				F	F	F		
Default				none	none	none		

VARIABLE**DESCRIPTION**

A1, A2, A3

Components of vector **a** for AOPT = 2

Card 8	1	2	3	4	5	6	7	8
Variable	V1	V2	V3	D1	D2	D3		
Type	F	F	F	F	F	F		
Default	none	none	none	none	none	none		

VARIABLE**DESCRIPTION**

V1, V2, V3

Components of vector **v** for AOPT = 3

D1, D2, D3

Components of vector **d** for AOPT = 2**Remarks:**

1. **Yield Surface.** A total of eight parameters (α_1 to α_8) are needed to describe the yield surface. The parameters can be determined with tensile tests in three directions and one equal biaxial tension test. For detailed theoretical background and material parameters of some typical FCC materials, see Remarks in *MAT_-133 and Barlat et al. (2003) paper.
2. **Yoshida Model.** For a more detailed description on the Yoshida model and parameters, see Remarks in *MAT_226 and *MAT_125.
3. **AOPT.** For information on the variable AOPT, see Remarks in *MAT_226.

4. **Convergence and Springback.** To improve convergence, it is recommended that *CONTROL_IMPLICIT_FORMING type '1' be used when conducting a springback simulation.

Revisions:

1. This material model is available starting in LS-DYNA R5 Revision 58432.
2. The variables EA, COE, SC1, and SC2 are available starting in Revision 133318.

***MAT_HILL_90**

This is Material Type 243. This model was developed by Hill [1990] for modeling sheets with anisotropic materials under plane stress conditions. This material allows the use of the Lankford parameters for the definition of the anisotropy. All features of this model are the same as in *MAT_036, only the yield condition and associated flow rules are replaced by the Hill90 equations.

Card Summary:

Card 1. This card is required.

MID	RO	E	PR	HR	P1	P2	ITER
-----	----	---	----	----	----	----	------

Card 2a. This card is included if FLAG = 0 (see Card 4).

M	R00	R45	R90	LCID	E0	SPI	P3
---	-----	-----	-----	------	----	-----	----

Card 2b. This card is included if FLAG = 1 (see Card 4).

M	AH	BH	CH	LCID	E0	SPI	P3
---	----	----	----	------	----	-----	----

Card 3. This card is included if M < 0 on Card 2a/2b.

CRC1	CRA1	CRC2	CRA2	CRC3	CRA3	CRC4	CRA4
------	------	------	------	------	------	------	------

Card 4. This card is required.

AOPT	C	P	VLCID		FLAG		
------	---	---	-------	--	------	--	--

Card 5. This card is required.

			A1	A2	A3		
--	--	--	----	----	----	--	--

Card 6. This card is required.

V1	V2	V3	D1	D2	D3	BETA	
----	----	----	----	----	----	------	--

Card 7. This card is optional.

USRFAIL							
---------	--	--	--	--	--	--	--

Data Card Definitions:

Card 1	1	2	3	4	5	6	7	8
Variable	MID	RO	E	PR	HR	P1	P2	ITER
Type	A	F	F	F	F	F	F	F

VARIABLE**DESCRIPTION**

MID	Material identification. A unique number or label must be specified (see *PART).
RO	Mass density
E	Young's modulus, E GT.0.0: Constant value LT.0.0: Load curve ID = (-E) which defines Young's modulus as a function of plastic strain. See Remark 1.
PR	Poisson's ratio, ν
HR	Hardening rule: EQ.1.0: Linear (default) EQ.2.0: Exponential (Swift; see Remark 3) EQ.3.0: Load curve or table with strain rate effects (see Remark 1) EQ.4.0: Exponential (Voce; see Remark 3) EQ.5.0: Exponential (Gosh; see Remark 3) EQ.6.0: Exponential (Hockett-Sherby; see Remark 3) EQ.7.0: Load curves in three directions (see Remark 1) EQ.8.0: Table with temperature dependence (see Remark 1) EQ.9.0: 3D table with temperature and strain rate dependence (see Remark 1)
P1	Material parameter: HR.EQ.1.0: Tangent modulus,

VARIABLE	DESCRIPTION
	HR.EQ.2.0: k , strength coefficient for Swift exponential hardening
	HR.EQ.4.0: a , coefficient for Voce exponential hardening
	HR.EQ.5.0: k , strength coefficient for Gosh exponential hardening
	HR.EQ.6.0: a , coefficient for Hocket-Sherby exponential hardening
	HR.EQ.7.0: Load curve ID for hardening in 45 degree direction. See Remark 1 .

P2 Material parameter:

HR.EQ.1.0: Yield stress

HR.EQ.2.0: n , exponent for Swift exponential hardening

HR.EQ.4.0: c , coefficient for Voce exponential hardening

HR.EQ.5.0: n , exponent for Gosh exponential hardening

HR.EQ.6.0: c , coefficient for Hocket-Sherby exponential hardening

HR.EQ.7.0: Load curve ID for hardening in 90 degree direction. See [Remark 1](#).

ITER Iteration flag for speed:

EQ.0.0: Fully iterative

EQ.1.0: Fixed at three iterations

Generally, we recommend $ITER = 0.0$. However, $ITER = 1.0$ is somewhat faster and may give acceptable results in most problems.

Lankford Parameters Card. This card is included if $FLAG = 0$ on Card 4.

Card 2a	1	2	3	4	5	6	7	8
Variable	M	R00	R45	R90	LCID	E0	SPI	P3
Type	F	F	F	F	I	F	F	F

VARIABLE	DESCRIPTION
M	m , exponent in Hill's yield surface. If negative, the absolute value is used. Typically, m ranges between 1 and 2 for low- r materials, such as aluminum (AA6111: $m \approx 1.5$) and is greater than 2 for high r -materials, as in steel (DP600: $m \approx 4$). See Remark 3 .
R00	Lankford parameter in 0 degree direction, R_{00} (see Remark 3): GT.0.0: Constant value LT.0.0: Load curve or table ID = (-R00) which defines R_{00} as a function of plastic strain (curve) or as a function of temperature and plastic strain (table). See Remarks 1 and 2 .
R45	Lankford parameter in 45 degree direction, R_{45} (see Remark 3): GT.0.0: Constant value LT.0.0: Load curve or table ID = (-R45) which defines R_{45} as a function of plastic strain (curve) or as a function of temperature and plastic strain (table). See Remarks 1 and 2 .
R90	Lankford parameter in 90 degree direction, R_{90} (see Remark 3): GT.0.0: Constant value LT.0.0: Load curve or table ID = (-R90) which defines R_{90} as a function of plastic strain (curve) or as a function of temperature and plastic strain (table). See Remarks 1 and 2 .
LCID	Load curve/table ID for hardening in the 0 degree direction (applies for HR = 3, 7, 8, and 9). See Remark 1 .
E0	Material parameter (see Remark 3): HR.EQ.2.0: ε_0 for determining initial yield stress for Swift exponential hardening (default = 0.0) HR.EQ.4.0: b , coefficient for Voce exponential hardening HR.EQ.5.0: ε_0 for determining initial yield stress for Gosh exponential hardening (default = 0.0) HR.EQ.6.0: b , coefficient for Hockett-Sherby exponential hardening
SPI	Case I: If ε_0 is zero above and HR = 2.0 (see Remark 3). (Default = 0.0) EQ.0.0: $\varepsilon_0 = \left(\frac{E}{k}\right)^{1/(n-1)}$

VARIABLE	DESCRIPTION
	LE.0.02: $\epsilon_0 = \text{SPI}$
	GT.0.02: $\epsilon_0 = \left(\frac{\text{SPI}}{k}\right)^{1/n}$
	Case II: If HR = 5.0 the strain at plastic yield is determined by an iterative procedure based on the same principles as for HR = 2.0 (see Remark 3).
P3	Material parameter (see Remark 3):
	HR.EQ.5.0: p , parameter for Gosh exponential hardening
	HR.EQ.6.0: n , exponent for Hockett-Sherby exponential hardening

Hill90 Parameters Card. This card is included for FLAG = 1.

Card 2b	1	2	3	4	5	6	7	8
Variable	M	AH	BH	CH	LCID	E0	SPI	P3
Type	F	F	F	F	I	F	F	F

VARIABLE	DESCRIPTION
M	m , exponent in Hill's yield surface. If negative, the absolute value is used. Typically, m ranges between 1 and 2 for low- R materials, such as aluminum (AA6111: $m \approx 1.5$) and is greater than 2 for high R -materials, as in steel (DP600: $m \approx 4$). See Remark 3.
AH	a , Hill90 parameter (see Remark 3)
BH	b , Hill90 parameter (see Remark 3)
CH	c , Hill90 parameter (see Remark 3)
LCID	Load curve/table ID for hardening in the 0 degree direction (applies for HR = 3, 7, 8, and 9). See Remark 1.
E0	Material parameter (see Remark 3):
	HR.EQ.2.0: ϵ_0 for determining initial yield stress for Swift exponential hardening (default = 0.0)
	HR.EQ.4.0: b , coefficient for Voce exponential hardening

VARIABLE	DESCRIPTION
	HR.EQ.5.0: ε_0 for determining initial yield stress for Gosh exponential hardening (default = 0.0)
	HR.EQ.6.0: b , coefficient for Hocket-Sherby exponential hardening
SPI	Case I: If ε_0 is zero above and HR = 2.0 (see Remark 3). (default = 0.0) EQ.0.0: $\varepsilon_0 = (E/k)^{1/(n-1)}$ LE.0.02: $\varepsilon_0 = \text{SPI}$ GT.0.02: $\varepsilon_0 = (\text{SPI}/k)^{1/n}$ Case II: If HR = 5.0 the strain at plastic yield is determined by an iterative procedure based on the same principles as for HR = 2.0 (see Remark 3).
P3	Material parameter (see Remark 3): HR.EQ.5.0: p , parameter for Gosh exponential hardening HR.EQ.6.0: n , exponent for Hocket-Sherby exponential hardening

Hardening Card. Additional Card for M < 0.

Card 3	1	2	3	4	5	6	7	8
Variable	CRC1	CRA1	CRC2	CRA2	CRC3	CRA3	CRC4	CRA4
Type	F	F	F	F	F	F	F	F

VARIABLE	DESCRIPTION
$\text{CRC}n$	Chaboche-Rousselier hardening parameters. See Remark 4
$\text{CRA}n$	Chaboche-Rousselier hardening parameters. See Remark 4 .

Card 4	1	2	3	4	5	6	7	8
Variable	AOPT	C	P	VLCID		FLAG		
Type	F	F	F	I		F		

VARIABLE**DESCRIPTION**

AOPT

Material axes option (see `MAT_OPTIONTROPIC_ELASTIC` for a more complete description):

EQ.0.0: Locally orthotropic with material axes determined by element nodes 1, 2, and 4, as with `*DEFINE_COORDINATE_NODES`. The material axes are then rotated about the normal vector to the surface of the shell by the angle BETA.

EQ.2.0: Globally orthotropic with material axes determined by vectors defined below, as with `*DEFINE_COORDINATE_VECTOR`.

EQ.3.0: Locally orthotropic material axes determined by a vector \mathbf{v} and the normal vector to the plane of the element \mathbf{a} is determined by taking the cross product of \mathbf{v} with the normal vector, \mathbf{b} is determined by taking the cross product of the normal vector with \mathbf{a} , and \mathbf{c} is the normal vector. Then \mathbf{a} and \mathbf{b} are rotated about \mathbf{c} by an angle BETA. BETA may be set in the keyword input for the element or in the input for this keyword.

LT.0.0: The absolute value of AOPT is a coordinate system ID number (CID on `*DEFINE_COORDINATE_NODES`, `*DEFINE_COORDINATE_SYSTEM` or `*DEFINE_COORDINATE_VECTOR`).

C

C in Cowper-Symonds strain rate model (see [Remark 3](#))

P

p in Cowper-Symonds strain rate model (see [Remark 3](#)). $p = 0.0$ for no strain rate effects.

VLCID

Volume correction curve ID defining the relative volume change (change in volume relative to the initial volume) as a function of the effective plastic strain. This is only used when nonzero. See [Remark 1](#).

VARIABLE**DESCRIPTION**

FLAG

Flag for interpretation of parameters. If FLAG = 1, parameters AH, BH, and CH are read instead of R00, R45, and R90. See [Remark 3](#).

Card 5	1	2	3	4	5	6	7	8
Variable				A1	A2	A3		
Type				F	F	F		

VARIABLE**DESCRIPTION**

A1, A2, A3

Components of vector **a** for AOPT = 2

Card 6	1	2	3	4	5	6	7	8
Variable	V1	V2	V3	D1	D2	D3	BETA	
Type	F	F	F	F	F	F	F	

VARIABLE**DESCRIPTION**

V1, V2, V3

Components of vector **v** for AOPT = 3

D1, D2, D3

Components of vector **d** for AOPT = 2

BETA

Material angle in degrees for AOPT = 0 and 3. It may be overridden on the element card; see *ELEMENT_SHELL_BETA.

This card is optional.

Card 7	1	2	3	4	5	6	7	8
Variable	USRFAIL							
Type	F							

VARIABLE**DESCRIPTION**

USRFAIL

User defined failure flag:

VARIABLE

DESCRIPTION

EQ.0: No user subroutine is called

EQ.1: User subroutine `matusr_24` in `dyn21.f` is called.

Remarks:

1. **Plastic Strain in Curve Definitions.** The effective plastic strain used in this model is defined to be plastic work equivalent. A consequence of this is that for parameters defined as functions of effective plastic strain, the rolling (00) direction should be used as reference direction. For instance, the hardening curve for $HR = 3$ is the stress as function of strain for uniaxial tension in the rolling direction, the curve `VLCID` should give the relative volume change as function of strain for uniaxial tension in the rolling direction, and the load curve with `ID -E` should give the Young's modulus as function of strain for uniaxial tension in the rolling direction. Optionally the curve can be substituted for a table defining hardening as function of plastic strain rate ($HR = 3$), temperature ($HR = 8$), or both ($HR = 9$).

Exceptions from this rule are curves defined as functions of plastic strain in the 45 and 90 directions, such as `P1` and `P2` for $HR = 7$ and negative `R45` or `R90`. The hardening curves are here defined as measured stress as function of measured plastic strain for uniaxial tension in the direction of interest, meaning as determined from experimental testing using a standard procedure. Moreover, the curves defining the R -values are functions of the measured plastic strain for uniaxial tension in the direction of interest. These curves are transformed internally to be used with the effective stress and strain properties in the actual model. The effective plastic strain does not coincide with the plastic strain components in directions other than the rolling direction and may be somewhat confusing. Therefore, the von Mises work equivalent plastic strain is output as history variable #2 if $HR = 7$ or if any R -value is defined as function of the plastic strain.

2. **Determining R -Values from Curves.** The R -values in curves are defined as the ratio of instantaneous width change to instantaneous thickness change. That is, assume that the width W and thickness T are measured as a function of strain. Then the corresponding R -value is given by:

$$R = \frac{\frac{dW}{d\varepsilon} / W}{\frac{dT}{d\varepsilon} / T}$$

3. **Yield Criterion, Hill90 Parameters, and Hardening Models.** The anisotropic yield criterion Φ for plane stress is defined as:

$$\Phi = K_1^m + K_3 K_2^{(m/2)-1} + c^m K_4^{m/2} = (1 + c^m - 2a + b) \sigma_Y^m$$

where σ_Y is the yield stress. $K_i, i = 1, \dots, 4$ are given by:

$$\begin{aligned} K_1 &= |\sigma_x + \sigma_y| \\ K_2 &= |\sigma_x^2 + \sigma_y^2 + 2\sigma_{xy}| \\ K_3 &= -2a(\sigma_x^2 - \sigma_y^2) + b(\sigma_x - \sigma_y)^2 \\ K_4 &= |(\sigma_x - \sigma_y)^2 + 4\sigma_{xy}| \end{aligned}$$

If FLAG = 0, the anisotropic material constants a , b , and c are obtained through R_{00} , R_{45} , and R_{90} using these 3 equations:

$$\begin{aligned} 1 + 2R_{00} &= \frac{c^m - a + \{(m+2)/2m\}b}{1 - a + \{(m-2)/2m\}b} \\ 1 + 2R_{45} &= c^m \\ 1 + 2R_{90} &= \frac{c^m + a + \{(m+2)/2m\}b}{1 + a + \{(m-2)/2m\}b} \end{aligned}$$

If FLAG = 1, material parameters a (AH), b (BH), and c (CH) are used directly.

For material parameters a , b , c , and m , the following condition must be fulfilled, otherwise an error termination occurs:

$$1 + c^m - 2a + b > 0$$

Two even more strict conditions should be satisfied to ensure convexity of the yield surface according to Hill (1990). A warning message will be output if at least one of them is violated:

$$\begin{aligned} b &> -2\left(\frac{m}{2}\right)^{-1}c^m \\ b &> a^2 - c^m \end{aligned}$$

For the Swift hardening law (HR = 2), the yield strength of the material can be expressed in terms of k and n :

$$\sigma_Y = k\varepsilon^n = k(\varepsilon_0 + \bar{\varepsilon}^p)^n$$

where ε_0 is the elastic strain to yield and $\bar{\varepsilon}^p$ is the effective plastic strain (logarithmic). ε_0 can be given in the input with E0 or determined using SPI. If E0 and SPI are both set to zero, the strain to yield is found by solving for the intersection of the linearly elastic loading equation with the strain hardening equation:

$$\begin{aligned} \sigma &= E\varepsilon \\ \sigma &= k\varepsilon^n \end{aligned}$$

which gives the elastic strain at yield as:

$$\varepsilon_0 = \left(\frac{E}{k}\right)^{\left[\frac{1}{n-1}\right]}$$

If E0 is zero and SPI is nonzero and greater than 0.02 then:

$$\epsilon_0 = \left(\frac{\sigma_Y}{k}\right)^{\left[\frac{1}{n}\right]}$$

The other available hardening models include the Voce equation (HR = 4) given by

$$\sigma_Y(\epsilon_p) = a - be^{-c\epsilon_p},$$

the Gosh equation (HR = 5) given by

$$\sigma_Y(\epsilon_p) = k(\epsilon_0 + \epsilon_p)^n - p,$$

and finally, the Hockett-Sherby equation (HR = 6) given by

$$\sigma_Y(\epsilon_p) = a - be^{-c\epsilon_p^n}.$$

For the Gosh hardening law, the interpretation of the variable SPI is the same as for the Swift hardening law, meaning if set to zero (along with E0), the strain at yield is determined implicitly from the intersection of the strain hardening equation with the linear elastic equation.

To include strain rate effects in the model, we multiply the yield stress by a factor depending on the effective plastic strain rate. We use the Cowper-Symonds model, hence the yield stress can be written

$$\sigma_Y(\epsilon_p, \dot{\epsilon}_p) = \sigma_Y^s(\epsilon_p) \left[1 + \left(\frac{\dot{\epsilon}_p}{C}\right)^{1/p} \right].$$

Here σ_Y^s denotes the static yield stress, C and p are material parameters, and $\dot{\epsilon}_p$ is the effective plastic strain rate.

- Kinematic Hardening Model.** A kinematic hardening model is implemented following the works of Chaboche and Roussilier. A back stress α is introduced such that the effective stress is computed as

$$\sigma_{\text{eff}} = \sigma_{\text{eff}}(\sigma_{11} - 2\alpha_{11} - \alpha_{22}, \sigma_{22} - 2\alpha_{22} - \alpha_{11}, \sigma_{12} - \alpha_{12})$$

The back stress is the sum of up to four terms according to

$$\alpha_{ij} = \sum_{k=1}^4 \alpha_{ij}^k$$

and the evolution of each back stress component is as follows

$$\delta\alpha_{ij}^k = C_k \left(a_k \frac{s_{ij} - \alpha_{ij}}{\sigma_{\text{eff}}} - \alpha_{ij}^k \right) \delta\epsilon_p$$

where C_k and a_k are material parameters, s_{ij} is the deviatoric stress tensor, σ_{eff} is the effective stress, and ϵ_p is the effective plastic strain.

***MAT_UHS_STEEL**

This is Material Type 244. This material model is developed for both shell and solid models. It is mainly suited for hot stamping processes where phase transformations are crucial. It has five phases, and it is assumed that the blank is fully austenitized before cooling. The model also includes optional algorithms for switching between heating and cooling. The basic constitutive model is based on the work done by P. Akerstrom [2, 7].

NOTE 1: For this material “weight%” means “ppm × 10⁻⁴”.

NOTE 2: We include baseline values in the variable tables as possible starting values that lead to reasonable results for an alloy called 22MnB5. The values are taken from the literature.

Card Summary:

Card 1. This card is required.

MID	RO	E	PR	TUNIT	CRSH	PHASE	HEAT
-----	----	---	----	-------	------	-------	------

Card 2. This card is required.

LCY1	LCY2	LCY3	LCY4	LCY5	KFER	KPER	B
------	------	------	------	------	------	------	---

Card 3. This card is required.

C	Co	Mo	Cr	Ni	Mn	Si	V
---	----	----	----	----	----	----	---

Card 4. This card is required.

W	Cu	P	Al	As	Ti	CWM	LCTRE
---	----	---	----	----	----	-----	-------

Card 5. This card is required.

THEXP1	THEXP5	LCTH1	LCTH5	TREF	LAT1	LAT5	TABTH
--------	--------	-------	-------	------	------	------	-------

Card 6. This card is required.

QR2	QR3	QR4	ALPHA	GRAIN	TOFFE	TOFPE	TOFBA
-----	-----	-----	-------	-------	-------	-------	-------

Card 7. This card is required.

PLMEM2	PLMEM3	PLMEM4	PLMEM5	STRC	STRP	REACT	TEMPER
--------	--------	--------	--------	------	------	-------	--------

Card 8. This card is included if HEAT = 1.

AUST	FERR	PEAR	BAIN	MART	GRK	GRQR	TAU1
------	------	------	------	------	-----	------	------

Card 9. This card is included if HEAT = 1.

GRA	GRB	EXPA	EXPB	GRCC	GRCM	HEATN	TAU2
-----	-----	------	------	------	------	-------	------

Card 10. This card is included if REACT = 1.

FS	PS	BS	MS	MSIG	LCEPS23	LCEPS4	LCEPS5
----	----	----	----	------	---------	--------	--------

Card 11. This card is included if TEMPER = 1.

LCH4	LCH5	DTCRIT	TSAMP				
------	------	--------	-------	--	--	--	--

Card 12. This card is included if CWM = 1.

TASTART	TAEND	TLSTART	TLEND	EGHOST	PGHOST	AGHOST	
---------	-------	---------	-------	--------	--------	--------	--

Data Card Definitions:

Card 1	1	2	3	4	5	6	7	8
Variable	MID	RO	E	PR	TUNIT	CRSH	PHASE	HEAT
Type	A	F	F	F	F	I	I	I
Defaults	none	none	none	none	3600	0	0	0

VARIABLE	DESCRIPTION	BASELINE VALUE
MID	Material identification. A unique number or label must be specified (see *PART).	
RO	Material density	7830 Kg/m ³
E	Young's modulus: GT.0.0: Constant value	100 GPa [1]

VARIABLE	DESCRIPTION	BASELINE VALUE
	LT.0.0: Temperature dependent Young's modulus given by load curve or table ID = -E. See Remark 9 for more information about using a table to specify the Young's modulus.	
PR	Poisson's ratio: GT.0.0: Constant value LT.0.0: Temperature dependent Poisson ratio given by load curve or table ID = -PR. The table input is described in Remark 9 .	0.30 [1]
TUNIT	Number of time units per hour. Default is seconds, that is, 3600 time units per hour. TUNIT is used only for hardness calculations.	3600.
CRSH	Switch to use a simple and fast material model but with the actual phases active. EQ.0: The original model where phase transitions are active and trip is used. EQ.1: A simpler and faster version. This option is mainly used when transferring the quenched blank into a crash analysis where all properties from the cooling are maintained. This option must be used with a *INTERFACE_SPRINGBACK keyword and should be used after a quenching analysis. EQ.2: Same as 0 but trip effect is not used.	0
PHASE	Switch to include or exclude middle phases from the simulation. EQ.0: All phases active (default) EQ.1: Pearlite and bainite excluded EQ.2: Bainite excluded EQ.3: Ferrite and pearlite excluded	0

VARIABLE	DESCRIPTION	BASELINE VALUE
	EQ.4: Ferrite and bainite excluded EQ.5: Exclude middle phases (only austenite → martensite)	
HEAT	<p>Switch to activate the heating algorithms (see Remarks 7 and 8):</p> <p>EQ.0: Heating is not activated which means that no transformation to austenite is possible.</p> <p>EQ.1: Heating is activated which means that only transformation to austenite is possible.</p> <p>EQ.2: Automatic switching between cooling and heating. LS-DYNA checks the temperature gradient and calls the appropriate algorithms. For example, this can be used to simulate the heat affected zone during welding.</p> <p>LT.0: The switch between cooling and heating is defined by a time dependent load curve with ID = HEAT . The ordinate should be 1.0 when heating is applied and 0.0 if cooling is preferable.</p>	

Card 2	1	2	3	4	5	6	7	8
Variable	LCY1	LCY2	LCY3	LCY4	LCY5	KFER	KPER	B
Type	I	I	I	I	I	F	F	F
Defaults	none	none	none	none	none	0.0	0.0	0.0

VARIABLE	DESCRIPTION	BASELINE VALUE
LCY1	<p>Load curve or table ID for austenite hardening.</p> <p>Load Curve. When LCY1 is a load curve ID, it defines input yield stress as a function of effective plastic strain.</p> <p>Tabular Data (LCY1 > 0). When LCY1 is greater than 0 and references a table ID, a 2D table references for each temperature value a hardening curve.</p> <p>Tabular Data (LCY1 < 0). When LCY1 is less than 0, LCY1 is a 3D table ID. Each input temperature value gives a table ID which defines for each a strain rate a hardening curve.</p>	
LCY2	Load curve ID for ferrite hardening (stress as a function of effective plastic strain)	
LCY3	Load curve or table ID for pearlite. See LCY1 for description.	
LCY4	Load curve or table ID for bainite. See LCY1 for description.	
LCY5	Load curve or table ID for martensite. See LCY1 for description.	
KFERR	Correction factor for boron in the ferrite reaction.	1.9×10^5 [2]
KPEAR	Correction factor for boron in the pearlite reaction.	3.1×10^3 [2]
B	Boron [weight %]	0.003 [2]

Card 3	1	2	3	4	5	6	7	8
Variable	C	Co	Mo	Cr	Ni	Mn	Si	V
Type	F	F	F	F	F	F	F	F
Defaults	0.0	0.0	0.0	0.0	0.0	0.0	0.0	0.0

VARIABLE	DESCRIPTION	BASELINE VALUE
C	Carbon [weight %]	0.23 [2]
Co	Cobolt [weight %]	0.0 [2]
Mo	Molybdenum [weight %]	0.0 [2]
Cr	Chromium [weight %]	0.21 [2]
Ni	Nickel [weight %]	0.0 [2]
Mn	Manganese [weight %]	1.25 [2]
Si	Silicon [weight %]	0.29 [2]
V	Vanadium [weight %]	0.0 [2]

Card 4	1	2	3	4	5	6	7	8
Variable	W	Cu	P	Al	As	Ti	CWM	LCTRE
Type	F	F	F	F	F	F	I	I
Defaults	0.0	0.0	0.0	0.0	0.0	0.0	0	none

VARIABLE	DESCRIPTION	BASELINE VALUE
W	Tungsten [weight %]	0.0 [2]
Cu	Copper [weight %]	0.0 [2]

VARIABLE	DESCRIPTION	BASELINE VALUE
P	Phosphorous [weight %]	0.013 [2]
Al	Aluminum [weight %]	0.0 [2]
As	Arsenic [weight %]	0.0 [2]
Ti	Titanium [weight %]	0.0 [2]
CWM	Flag for computational welding mechanics input. One additional input card is read. EQ.1.0: Active EQ.0.0: Inactive	
LCTRE	Load curve for transformation induced strains. See Remark 14 .	

Card 5	1	2	3	4	5	6	7	8
Variable	THEXP1	THEXP5	LCTH1	LCTH5	TREF	LAT1	LAT5	TABTH
Type	F	F	I	I	F	F	F	I
Defaults	0.0	0.0	none	none	273.15	0.0	0.0	none

VARIABLE	DESCRIPTION	BASELINE VALUE
THEXP1	Coefficient of thermal expansion in austenite	25.1×10^{-6} 1/K [7]
THEXP5	Coefficient of thermal expansion in martensite	11.1×10^{-6} 1/K [7]
LCTH1	Load curve for the thermal expansion coefficient for austenite: LT.0: Curve ID = -LCTH1 and TREF is used as reference temperature GT.0: Curve ID = LCTH1	0

VARIABLE	DESCRIPTION	BASELINE VALUE
LCTH5	<p>Load curve for the thermal expansion coefficient for martensite:</p> <p>LT.0: Curve ID = -LCTH5 and TREF is used as reference temperature</p> <p>GT.0: Curve ID = LCTH5</p>	0
TREF	Reference temperature for thermal expansion. Used if LCTH1 < 0.0, LCTH5 < 0.0, or TABTH < 0.	293.15
LAT1	<p>Latent heat for the decomposition of austenite into ferrite, pearlite and bainite.</p> <p>GT.0.0: Constant value</p> <p>LT.0.0: Load curve ID or table ID. See Remark 10 for more information.</p>	$590 \times 10^6 \text{ J/m}^3$ [2]
LAT5	<p>Latent heat for the decomposition of austenite into martensite.</p> <p>GT.0.0: Constant value</p> <p>LT.0.0: Load curve ID giving latent heat as a function of temperature</p> <p>Note that LAT5 is ignored if a table ID is used in LAT1.</p>	$640 \times 10^6 \text{ J/m}^3$ [2]
TABTH	<p>Table ID for thermal expansion coefficient. With this option active THEXP1, THEXP2, LCTH1 and LCTH5 are ignored. See Remark 11.</p> <p>GT.0: A table for instantaneous thermal expansion (TREF is ignored).</p> <p>LT.0: A table with thermal expansion with reference to TREF.</p>	

Card 6	1	2	3	4	5	6	7	8
Variable	QR2	QR3	QR4	ALPHA	GRAIN	TOFFE	TOFPE	TOFBA
Type	F	F	F	F	F	F	F	F
Defaults	0.0	0.0	0.0	0.0	0.0	0.0	0.0	0.0

<u>VARIABLE</u>	<u>DESCRIPTION</u>	<u>BASELINE VALUE</u>
QR2	Activation energy divided by the universal gas constant for the diffusion reaction of the austenite-ferrite reaction: $Q2/R$. $R = 8.314472$ [J/mol K].	10324 K [3] = (23000 cal/mole) × (4.184 J/cal) / (8.314 J/mole/K)
QR3	Activation energy divided by the universal gas constant for the diffusion reaction for the austenite-pearlite reaction: $Q3/R$. $R = 8.314472$ [J/mol K].	13432. K [3]
QR4	Activation energy divided by the universal gas constant for the diffusion reaction for the austenite-bainite reaction: $Q4/R$. $R = 8.314472$ [J/mol K].	15068. K [3]
ALPHA	Material constant for the martensite phase. A value of 0.011 means that 90% of the available austenite is transformed into martensite at 210 degrees below the martensite start temperature (see <code>messag</code> file for information), whereas a value of 0.033 means a 99.9% transformation.	0.011
GRAIN	ASTM grain size number for austenite, usually a number between 7 and 11.	6.8
TOFFE	Number of degrees that the ferrite is bleeding over into the pearlite reaction	0.0
TOFPE	Number of degrees that the pearlite is bleeding over into the bainite reaction	0.0

VARIABLE	DESCRIPTION	BASELINE VALUE
TOFBA	Number of degrees that the bainite is bleeding over into the martensite reaction	0.0

Card 7	1	2	3	4	5	6	7	8
Variable	PLMEM2	PLMEM3	PLMEM4	PLMEM5	STRC	STRP	REACT	TEMPER
Type	I	F	F	F	F	F	I	I
Defaults	0.0	0.0	0.0	0.0	0.0	0.0	0	0

VARIABLE	DESCRIPTION	BASELINE VALUE
PLMEM2	Memory coefficient for the plastic strain that is carried over from the austenite. A value of 1 means that all plastic strains from austenite is transferred to the <i>ferrite</i> phase and a value of 0 means that nothing is transferred.	0.0
PLMEM3	Same as PLMEM2 but between austenite and pearlite	0.0
PLMEM4	Same as PLMEM2 but between austenite and bainite	0.0
PLMEM5	Same as PLMEM3 but between austenite and martensite	0.0
STRC	Effective strain rate parameter <i>C</i> . LT.0.0: load curve ID = -STRC GT.0.0: constant value EQ.0.0: strain rate NOT active	0.0
STRP	Effective strain rate parameter <i>P</i> . LT.0.0: load curve ID = -STRP GT.0.0: constant value	0.0

VARIABLE	DESCRIPTION	BASELINE VALUE
	EQ.0.0: strain rate NOT active	
REACT	Flag for advanced reaction kinetics input. One additional input card is read. EQ.1.0: active EQ.0.0: inactive	0.0
TEMPER	Flag for tempering input. One additional input card is read. EQ.1.0: active EQ.0.0: inactive	0.0

Heat Card 1. Additional Card for HEAT = 1.

Card 8	1	2	3	4	5	6	7	8
Variable	AUST	FERR	PEAR	BAIN	MART	GRK	GRQR	TAU1
Type	F	F	F	F	F	F	F	F
Default	0.0	0.0	0.0	0.0	0.0	0.0	0.0	2.08E8

VARIABLE	DESCRIPTION	BASELINE VALUE
AUST	If a heating process is initiated at $t = 0$, this field sets the initial amount of austenite in the blank. If heating is activated at $t > 0$ during a simulation, this value is ignored. Note that, $\text{AUST} + \text{FERR} + \text{PEAR} + \text{BAIN} + \text{MART} = 1.0$	0.0
FERR	See AUST for description	0.0
PEAR	See AUST for description	0.0
BAIN	See AUST for description	0.0

VARIABLE	DESCRIPTION	BASELINE VALUE
MART	See AUST for description	0.0
GRK	Growth parameter k ($\mu\text{m}^2/\text{sec}$)	10^{11} [9]
GRQR	Grain growth activation energy (J/mol) divided by the universal gas constant: Q/R where $R = 8.314472$ (J/mol K)	3×10^4 [9]
TAU1	Empirical grain growth parameter c_1 describing the function $\tau(T)$	2.08×10^8 [9]

Heat Card 2. Additional Card for HEAT =1.

Card 9	1	2	3	4	5	6	7	8
Variable	GRA	GRB	EXPA	EXPB	GRCC	GRCM	HEATN	TAU2
Type	F	F	F	F	F	F	F	F
Default	3.11	7520.	1.0	1.0	none	none	1.0	4.806

VARIABLE	DESCRIPTION	BASELINE VALUE
GRA	Grain growth parameter A	[9]
GRB	Grain growth parameter B . A table of recommended values of GRA and GRB is included in Remark 8 .	[9]
EXPA	Grain growth parameter a	1.0 [9]
EXPB	Grain growth parameter b	1.0 [9]
GRCC	Grain growth parameter with the concentration of non-metals in the blank, weight% of C or N	[9]
GRCM	Grain growth parameter with the concentration of metals in the blank, lowest weight% of Cr, V, Nb, Ti, Al	[9]

VARIABLE	DESCRIPTION	BASELINE VALUE
HEATN	Grain growth parameter n for the austenite formation	1.0 [9]
TAU2	Empirical grain growth parameter c_2 describing the function $\tau(T)$	4.806 [9]

Reaction Card. Addition card for REACT = 1.

Card 10	1	2	3	4	5	6	7	8
Variable	FS	PS	BS	MS	MSIG	LCEPS23	LCEPS4	LCEPS5
Type	F	F	F	F	F	I	I	I
Default	0.0	0.0	0.0	0.0	none	none	none	none

VARIABLE	DESCRIPTION	BASELINE VALUE
FS	Manual start temperature Ferrite GT.0.0: Same temperature is used for heating and cooling. LT.0.0: Different start temperatures for cooling and heating given by load curve ID = -FS. First ordinate value is used for cooling, last ordinate value for heating.	
PS	Manual start temperature Pearlite. See FS for description.	
BS	Manual start temperature Bainite. See FS for description.	
MS	Manual start temperature Martensite. See FS for description.	
MSIG	Describes the increase of martensite start temperature for cooling due to applied stress.	

VARIABLE	DESCRIPTION	BASELINE VALUE
	<p>LT.0: Load curve ID describes MSIG as a function of triaxiality (pressure / effective stress).</p> $MS^* = MS + MSIG \times \sigma_{eff}$	
LCEPS23	<p>Load curve ID dependent on plastic strain that scales the activation energy QR2 and QR3.</p> $QRx = Qx \times LCEPS23(\epsilon_{pl})/R$	
LCEPS4	<p>Load Curve ID dependent on plastic strain that scales the activation energy QR4.</p> $QR4 = Q4 \times LCEPS4(\epsilon_{pl})/R$	
LCEPS5	<p>Load curve ID which describe the increase of the martensite start temperature for cooling as a function of plastic strain.</p> $MS^* = MS + MSIG \times \sigma_{eff} + LCEPS5(\epsilon_{pl})$	

Tempering Card. Additional card for TEMPR = 1.

Card 11	1	2	3	4	5	6	7	8
Variable	LCH4	LCH5	DTCRIT	TSAMP				
Type	I	I	F	F				
Default	0	0	0.0	0.0				

VARIABLE	DESCRIPTION	BASELINE VALUE
LCH4	Load curve ID of Vicker hardness as a function of temperature for Bainite hardness calculation	
LCH5	Load curve ID of Vicker hardness as a function of temperature for Martensite hardness calculation	

VARIABLE	DESCRIPTION	BASELINE VALUE
DTCRIT	Critical cooling rate to detect holding phase	
TSAMP	Sampling interval for temperature rate monitoring to detect the holding phase	

Computational Welding Mechanics Card. Additional card for CWM = 1.

Card 12	1	2	3	4	5	6	7	8
Variable	TASTART	TAEND	TLSTART	TLEND	EGHOST	PGHOST	AGHOST	
Type	F	F	F	F	F	F	F	
Default	0.0	0.0	0.0	0.0	0.0	0.0	0.0	

VARIABLE	DESCRIPTION	BASELINE VALUE
TASTART	Annealing temperature start	
TAEND	Annealing temperature end	
TLSTART	Birth temperature start	
EGHOST	Young's modulus for ghost (quiet) material	
PGHOST	Poisson's ratio for ghost (quiet) material	
AGHOST	Thermal expansion coefficient for ghost (quiet) material	

Discussion:

The phase distribution during cooling is calculated by solving the following rate equation for each phase transition

$$\dot{X}_k = g_k(G, C, T_k, Q_k) f_k(X_k) , \quad k = 2,3,4$$

where g_k is a function, taken from Li et al., dependent on the grain number G , the chemical composition C , the temperature T , and the activation energy Q . Moreover, the function f_k is dependent on the actual phase $X_k = x_k/x_{eq}$

$$f_k(X_k) = X_k^{0.4(X_k-1)}(1 - X_k)^{0.4X_k} , \quad k = 2,3,4$$

The true amount of martensite, that is, $k = 5$, is modelled by using the true amount of the austenite left after the bainite phase:

$$x_5 = x_1[1 - e^{-\alpha(MS-T)}] ,$$

where x_1 is the true amount of austenite left for the reaction, α is a material dependent constant and MS is the start temperature of the martensite reaction.

The start temperatures are automatically calculated based on the composition:

1. Ferrite,

$$FS = 1185 - 203 \times \sqrt{C} - 15.2 \times Ni + 44.7 \times Si + 104 \times V + 31.5 \times Mo + 13.1 \times W - 30 \times Mn - 11 \times Cr - 20 \times Cu + 700 \times P + 400 \times Al + 120 \times As + 400 \times Ti$$

2. Pearlite,

$$PS = 996 - 10.7 \times Mn - 16.9 \times Ni + 29 \times Si + 16.9 \times Cr + 290 \times As + 6.4 \times W$$

3. Bainite,

$$BS = 910 - 58 \times C - 35 \times Mn - 15 \times Ni - 34 \times Cr - 41 \times Mo$$

4. Martensite,

$$MS = 812 - 423 \times C - 30.4 \times Mn - 17.7 \times Ni - 12.1 \times Cr - 7.5 \times Mo + 10 \times Co - 7.5 \times Si$$

where the element weight values are input on Cards 2 through 4.

The automatic start temperatures are printed to the messag file and if they are not accurate enough you can manually set them in the input deck (must be set in absolute temperature, Kelvin). If HEAT > 0, the temperature FSnc (ferrite without C) is also echoed. If the specimen exceeds that temperature, all remaining ferrite is instantaneously transformed to austenite.

Remarks:

1. **History Variables.** History variables 1 through 8 include the different phases, the Vickers hardness, the yield stress and the ASTM grain size number. Set NEIPS = 8 (shells) or NEIPH = 8 (solids) on *DATABASE_EXTENT_BINARY.

History Variable	Description
1	Amount austenite
2	Amount ferrite

History Variable	Description
3	Amount pearlite
4	Amount bainite
5	Amount martensite
6	Vickers hardness
7	Yield stress
8	ASTM grain size number (a low value means large grains and vice versa)

2. **Excluding Phases.** To exclude a phase from the simulation, set the PHASE parameter accordingly.
3. **STRC and STRP.** Note that both strain rate parameters must be set to include the effect. It is possible to use a temperature dependent load curve for both parameters simultaneously or for one parameter keeping the other constant.
4. **TUNIT.** TUNIT is time units per hour and is only used for calculating the Vicker Hardness. By default, it is assumed that the time unit is seconds. If another time unit is used, for example milliseconds, then TUNIT must be changed to $TUNIT = 3.6 \times 10^6$
5. **TSF.** The thermal speedup factor TSF of *CONTROL_THERMAL_SOLVER is used to scale reaction kinetics and hardness calculations in this material model. Strain rate dependent properties (see LCY1 to LCY5 or STRC/STRP), however, are not scaled by TSF.
6. **CRSH.** With the CRSH = 1 option it is now possible to transfer the material properties from a hot stamping simulation (CRSH = 0) into another simulation. The CRSH = 1 option reads a dynain file from a simulation with CRSH = 0 and keeps all the history variables (austenite, ferrite, pearlite, bainite, martensite, etc.) constant. This will allow steels with inhomogeneous strength to be analyzed in, for example, a crash simulation. The speed with the CRSH = 1 option is comparable with *MAT_024. Note that for keeping the speed the temperature used in the CRSH simulation should be constant and the thermal solver should be inactive.
7. **Heating and Cooling and Transformation Temperatures.** To activate the heating algorithm, set HEAT = 1 or 2. HEAT = 0 (default) activates only the cooling algorithm. Note that for HEAT = 0 you *must* check that the initial temperature of this material is above the start temperature for the ferrite transformation. The transformation temperatures are echoed in the messag and d3hsp files.

If HEAT > 0 the temperature that instantaneously transforms all ferrite back to austenite is also echoed in the `messag` file. If you want to heat up to 100% austenite, you must let the specimen's temperature exceed that temperature.

8. **HEAT, Grain Growth, and Re-austenization.** When HEAT is activated the re-austenitization and grain growth algorithms are also activated. The grain growth is activated when the temperature exceeds a threshold value that is given by

$$T = \frac{B}{A - \log_{10}[(\text{GRCM})^a(\text{GRCC})^b]} ,$$

and the rate equation for the grain growth is,

$$\dot{g} = \frac{k}{2g} e^{-\frac{Q}{RT}} .$$

The rate equation for the phase re-austenitization is given in Oddy (1996) and is here mirrored

$$\dot{x}_a = n \left[\ln \left(\frac{x_{eu}}{x_{eu} - x_a} \right) \right]^{\frac{n-1}{n}} \left[\frac{x_{eu} - x_a}{\tau(T)} \right] ,$$

where n is the parameter HEATN. The temperature dependent function $\tau(T)$ is given from Oddy as $\tau(T) = c_1(T - T_s)^{c_2}$. The empirical parameters c_1 and c_2 are calibrated in Oddy to 2.06×10^8 and 4.806 respectively. Note that τ above given in *seconds*.

Recommended values for GRA and GRB are given in the following table.

Compound	Metal	Non-metal	GRA	GRB
Cr ₂₃ C ₆	Cr	C	5.90	7375
V ₄ C ₃	V	C _{0.75}	5.36	8000
TiC	Ti	C	2.75	7000
NbC	Nb	C _{0.7}	3.11	7520
Mo ₂ C	Mo	C	5.0	7375
Nb(CN)	Nb	(CN)	2.26	6770
VN	V	N	3.46 + 0.12%Mn	8330
AlN	Al	N	1.03	6770
NbN	Nb	N	4.04	10230
TiN	Ti	N	0.32	8000

9. **Using the Table Capability for Temperature Dependence of Young's Modulus.** Use *DEFINE_TABLE_2D and set the abscissa value equal to 1 for the austenite YM-curve, equal to 2 for the ferrite YM-curve, equal to 3 for the pearlite YM curve, equal to 4 for the bainite YM-curve and finally equal to 5 for the martensite YM-curve. If you use the PHASE option you only need to define the curves for the included phases, but you can define all five. LS-DYNA uses the number 1 - 5 to get the right curve for the right phase. The total YM is calculated by a linear mixture law: $YM = YM1 \times PHASE1 + \dots + YM5 \times PHASE5$. For example:

```
*DEFINE_TABLE_2D
$ The number before curve id:s define which phase the curve
$ will be applied to. 1 = Austenite, 2 = Ferrite, 3 = Pearlite,
$ 4 = Bainite and 5 = Martensite.
      1000      0.0      0.0
              1.0          100
              2.0          200
              3.0          300
              4.0          400
              5.0          500
$
$ Define curves 100 - 500
*DEFINE_CURVE
$ Austenite Temp (K) - YM-Curve (MPa)
      100      0      1.0      1.0
              1300.0      50.E+3
              223.0      210.E+3
```

10. **Using the Table Capability for Latent Heat.** When using a table ID for the latent heat (LAT1) you can describe all phase transition individually. Use *DEFINE_TABLE_2D and set the abscissa values to the corresponding phase transition number, that is, 2 for austenite to ferrite, 3 for austenite to pearlite, 4 for austenite to bainite and 5 for austenite to martensite. [Remark 9](#) demonstrates

the form of a correct table definition. If a curve is missing, the corresponding latent heat for that transition will be set to zero. Also, when a table is used the LAT5 is ignored. If HEAT > 0, you also have the option to include latent heat for the transition back to Austenite. This latent heat curve is marked as 1 in the table definition of LAT1.

11. **Using the Table Capability for Thermal Expansion.** When using a table ID for the thermal expansion you can specify the expansion characteristics for each phase. That is, you can have a curve for each of the 5 phases (austenite, ferrite, pearlite, bainite, and martensite). The input is identical to the above table definitions. The table must have the abscissa values between 1 and 5 where the number correspond to phase 1 to 5. To exclude one phase from influencing the thermal expansion you simply input a curve that is zero for that phase or even easier, exclude that phase number in the table definition. For example, to exclude the bainite phase you only define the table with curves for the indices 1, 2, 3 and 5.
12. **TEMPER.** Tempering is activated by setting TEMPER to 1. When active, the default hardness calculation for bainite and martensite is altered to use an incremental update formula. The total hardness is given by $\sum_{i=1}^5 HV_i \times x_i$. When holding phases are detected, the hardness for Bainite and Martensite is updated according to

$$HV_4^{n+1} = \frac{x_4^n}{x_4^{n+1}} HV_4^n + \frac{\Delta x_4}{x_4^{n+1}} h_4(T), \quad \Delta x_4 = x_4^{n+1} - x_4^n$$

$$HV_5^{n+1} = \frac{x_5^n}{x_5^{n+1}} HV_5^n + \frac{\Delta x_5}{x_5^{n+1}} h_5(T), \quad \Delta x_5 = x_5^{n+1} - x_5^n$$

We detect the holding phase for Bainite and Martensite when the temperature is in the appropriate range and if average temperature rate is below DTCRIT. The average temperature rate is calculated as $T_{\text{tresh}}/t_{\text{tresh}}$, where $T_{\text{tresh}}^{n+1} = T_{\text{tresh}}^n + |\dot{T}|\Delta t$ and $t_{\text{tresh}}^{n+1} = t_{\text{tresh}}^n + \Delta t$. The average temperature and time are updated until $t_{\text{tresh}} \geq t_{\text{samp}}$.

13. **CWM (Welding).** When computational welding mechanics is activated with CWM = 1, the material can be defined to be initially in a quiet state. In this state the material (often referred to as ghost material) has thermo-mechanical properties defined by an additional card. The material is activated when the temperature reaches the birth temperature. See MAT_CWM (MAT_270) for a detailed description.
14. **LCTRE (Transformation Induced Strains).** Transformation induced strains can be included with a load curve LCTRE as a function of temperature. The load curve represents the difference between the hard phases and the austenite phase in the dilatometer curves. Therefore, positive curve values result in a negative

transformation strain for austenitization and a positive transformation strain for the phase transformation from austenite to one of the hard phases.

References:

- [1] Numisheet 2008 Proceedings, The Numisheet 2008 Benchmark Study, Chapter 3, Benchmark 3, Continuous Press Hardening, Interlaken, Switzerland, Sept. 2008.
- [2] P. Akerstrom and M. Oldenburg, "Austenite Decomposition During Press hardening of a Boron Steel – Computer Simulation and Test", *Journal of Material processing technology*, 174 (2006), pp399-406.
- [3] M.V Li, D.V Niebuhr, L.L Meekisho and D.G Atteridge, "A Computatinal model for the prediction of steel hardenability", *Metallurgical and materials transactions B*, 29B, 661-672, 1998.
- [4] D.F. Watt, "An Algorithm for Modelling Microstructural Development in Weld Heat-Affected Zones (Part A) Reaction Kinetics", *Acta metal.* Vol. 36., No. 11, pp. 3029-3035, 1988.
- [5] ThyssenKrupp Steel, "Hot Press hardening Manganese-boron Steels MBW", product information Manganese-boron Steels, Sept. 2008.
- [6] Malek Naderi, "Hot Stamping of Ultra High Strength Steels", Doctor of Engineering Dissertation, Technical University Aachen, Germany, 2007.
- [7] P. Akerstrom, "Numerical Implementation of a Constitutive model for Simulation of Hot Stamping", Division of Solid Mechanics, Lulea University of technology, Sweden.
- [8] Malek Naderi, "A numerical and Experimental Investigation into Hot Stamping of Boron Alloyed Heat treated Steels", *Steel research Int.* 79 (2008) No. 2.
- [9] A.S. Oddy, J.M.J. McDill and L. Karlsson, "Microstructural predictions including arbitrary thermal histories, reaustenitization and carbon segregation effects" (1996).

Boron steel composition from the literature:

Element	HAZ code	Akerstrom (2)	Naderi (8)	ThyssenKrupp (5) (max amount)
B		0.003	0.003	0.005
C	0.168	0.23	0.230	0.250
Co				
Mo	0.036			0.250
Cr	0.255	0.211	0.160	0.250
Ni	0.015			
Mn	1.497	1.25	1.18	1.40
Si	0.473	0.29	0.220	0.400
V	0.026			
W				
Cu	0.025			
P	0.012	0.013	0.015	0.025
Al	0.020			
As				
Ti			0.040	0.05
S		0.003	0.001	0.010

***MAT_PML_OPTIONTROPIC_ELASTIC**

This is Material Type 245. This is a perfectly-matched layer (PML) material for orthotropic or anisotropic media. It is to be used in a wave-absorbing layer adjacent to an orthotropic/anisotropic material (*MAT_OPTIONTROPIC_ELASTIC) in order to simulate wave propagation in an unbounded ortho/anisotropic medium.

This material is a variant of *MAT_PML_ELASTIC (*MAT_230). It is available only for solid 8-node bricks (element type 2). The input cards exactly follow *MAT_OPTIONTROPIC_ELASTIC as shown below. See the variable descriptions and Remarks section of *MAT_OPTIONTROPIC_ELASTIC (*MAT_002) for further details.

Available options include:

ORTHO

ANISO

such that the keyword cards appear:

*MAT_PML_ORTHOTROPIC_ELASTIC or MAT_245 (4 cards follow)

*MAT_PML_ANISOTROPIC_ELASTIC or MAT_245_ANISO (5 cards follow)

Card Summary:

Card 1a.1. This card is required for the ORTHO keyword option.

MID	RO	EA	EB	EC	PRBA	PRCA	PRCB
-----	----	----	----	----	------	------	------

Card 1a.2. This card is required for the ORTHO keyword option.

GAB	GBC	GCA	AOPT	G	SIGF		
-----	-----	-----	------	---	------	--	--

Card 1b.1. This card is required for the ANISO keyword option.

MID	RO	C11	C12	C22	C13	C23	C33
-----	----	-----	-----	-----	-----	-----	-----

Card 1b.2. This card is required for the ANISO keyword option.

C14	C24	C34	C44	C15	C25	C35	C45
-----	-----	-----	-----	-----	-----	-----	-----

Card 1b.3. This card is required for the ANISO keyword option.

C55	C16	C26	C36	C46	C56	C66	AOPT
-----	-----	-----	-----	-----	-----	-----	------

Card 2. This card is required.

XP	YP	ZP	A1	A2	A3	MACF	
----	----	----	----	----	----	------	--

Card 3.

V1	V2	V3	D1	D2	D3	BETA	REF
----	----	----	----	----	----	------	-----

Data Card Definitions:

Orthotropic Card 1. Included for the ORTHO keyword option.

Card 1a.1	1	2	3	4	5	6	7	8
Variable	MID	RO	EA	EB	EC	PRBA	PRCA	PRCB
Type	A	F	F	F	F	F	F	F

Orthotropic Card 2. Included for the ORTHO keyword option.

Card 1a.2	1	2	3	4	5	6	7	8
Variable	GAB	GBC	GCA	AOPT	G	SIGF		
Type	F	F	F	F	F	F		

Anisotropic Card 1. Included for the ANISO keyword option.

Card 1b.1	1	2	3	4	5	6	7	8
Variable	MID	RO	C11	C12	C22	C13	C23	C33
Type	A	F	F	F	F	F	F	F

Anisotropic Card 2. Included for the ANISO keyword option.

Card 1b.2	1	2	3	4	5	6	7	8
Variable	C14	C24	C34	C44	C15	C25	C35	C45
Type	F	F	F	F	F	F	F	F

Anisotropic Card 3. Included for the ANISO keyword option.

Card 1b.3	1	2	3	4	5	6	7	8
Variable	C55	C16	C26	C36	C46	C56	C66	AOPT
Type	F	F	F	F	F	F	F	F

Card 2	1	2	3	4	5	6	7	8
Variable	XP	YP	ZP	A1	A2	A3	MACF	
Type	F	F	F	F	F	F	I	

Card 3	1	2	3	4	5	6	7	8
Variable	V1	V2	V3	D1	D2	D3	BETA	REF
Type	F	F	F	F	F	F	F	F

Remarks:

1. **Unboundedness.** A layer of this material may be placed at a boundary of a bounded domain to simulate unboundedness of the domain at that boundary. The layer absorbs and attenuates waves propagating outward from the domain, without any significant reflection of the waves back into the bounded domain. The layer cannot support any static displacement.
2. **Material Properties of Bounded Domain.** The material in the bounded domain near the layer is assumed to be, or behaves like, a linear ortho/anisotropic

material. The material properties of the layer should be set to the corresponding properties of this material.

3. **Layer Geometry.** The layer should form a cuboid box around the bounded domain, with the axes of the box aligned with the coordinate axes. Various faces of this box may be open, as required by the geometry of the problem. For instance, for a half-space problem, the “top” of the box should be open.

Internally, LS-DYNA partitions the entire PML into regions which form the “faces”, “edges” and “corners” of the above cuboid box. LS-DYNA generates a new material for each region. This partitioning will be visible in the d3plot file. You may safely ignore this partitioning.

4. **Number of Elements in the Layer.** The layer should have 5 - 10 elements through its depth. Typically, 5 - 6 elements are sufficient if the excitation source is reasonably distant from the layer, and 8 - 10 elements if it is close. The size of the elements should be similar to that of elements in the bounded domain near the layer and should be small enough to sufficiently discretize all significant wavelengths in the problem.
5. **Nodal Constraints.** The nodes on the outer boundary of the layer should be fully constrained using either *BOUNDARY_SPC or TC on *NODE. Other constraints — such as *CONSTRAINED_GLOBAL, or *BOUNDARY_PRESCRIBED_MOTION with a zero-valued load curve — will not be recognized. (Ansys Workbench uses the latter approach).
6. **Stress and Strain.** The stress and strain values reported by this material do not have any physical significance.

*MAT_PML_NULL

This is Material Type 246. This is a perfectly-matched layer (PML) material with a pressure fluid constitutive law computed using an equation of state, to be used in a wave-absorbing layer adjacent to a fluid material (*MAT_NULL with an EOS) in order to simulate wave propagation in an unbounded fluid medium. Only *EOS_LINEAR_POLYNOMIAL and *EOS_GRUNEISEN are allowed with this material. See the Remarks section of *MAT_NULL (*MAT_009) for further details. Accurate results are to be expected only for the case where the EOS presents a linear relationship between the pressure and volumetric strain.

This material is a variant of *MAT_PML_ELASTIC (*MAT_230) and is available only for solid 8-node bricks (element type 2).

Card	1	2	3	4	5	6	7	8
Variable	MID	RO	MU					
Type	A	F	F					
Default	none	none	0.0					

VARIABLE

DESCRIPTION

MID	Material identification. A unique number or label must be specified (see *PART).
RO	Mass density
MU	Dynamic viscosity coefficient

Remarks:

1. **Unboundedness.** A layer of this material may be placed at a boundary of a bounded domain to simulate unboundedness of the domain at that boundary: the layer absorbs and attenuates waves propagating outward from the domain, without any significant reflection of the waves back into the bounded domain. The layer cannot support any static displacement.
2. **Material Properties of Bounded Domain.** It is assumed the material in the bounded domain near the layer is, or behaves like, a linear fluid material. The material properties of the layer should be set to the corresponding properties of this material.

3. **Layer Geometry.** The layer should form a cuboid box around the bounded domain, with the axes of the box aligned with the coordinate axes. Various faces of this box may be open, as required by the geometry of the problem. For example, for a half-space problem, the “top” of the box should be open.

Internally, LS-DYNA will partition the entire PML into regions which form the “faces,” “edges” and “corners” of the above cuboid box and generate a new material for each region. This partitioning will be visible in the d3plot file. The user may safely ignore this partitioning.

4. **Number of Elements in the Layer.** The layer should have 5 - 10 elements through its depth. Typically, 5 - 6 elements are sufficient if the excitation source is reasonably distant from the layer, and 8 - 10 elements if it is close. The size of the elements should be similar to that of elements in the bounded domain near the layer, and should be small enough to sufficiently discretize all significant wavelengths in the problem.
5. **Nodal Constraints.** The nodes on the outer boundary of the layer should be fully constrained using either *BOUNDARY_SPC or TC on *NODE. Other constraints, such as *CONSTRAINED_GLOBAL or *BOUNDARY_PRESCRIBED_MOTION with a zero-valued load curve, will not be recognized.

Note that Ansys Mechanical uses *BOUNDARY_PRESCRIBED_MOTION with a zero-value load curve for fully constraining nodal degrees-of-freedom. Because of this limitation, you will have to edit the input file with a text editor.

6. **Stress and Strain.** The stress and strain values reported by this material do not have any physical significance.

*MAT_PHS_BMW

This is Material Type 248. This model is intended for hot stamping processes with phase transformation effects. It is available for shell elements *only* and is based on [Material Type 244 \(*MAT_UHS_STEEL\)](#). As compared with Material Type 244, Material Type 248 features:

1. a more flexible choice of evolution parameters,
2. an approach for transformation induced strains,
3. and a more accurate density calculation of individual phases.

Thus, the physical effects of the metal can be taken into account calculating the volume fractions of ferrite, pearlite, bainite and martensite for fast supercooling as well as for slow cooling conditions. Furthermore, this material model features cooling-rate dependence for several of its more crucial material parameters in order to accurately calculate the Time-Temperature-Transformation diagram dynamically. A detailed description can be found in Hippchen et al. [2013] and Hippchen [2014].

NOTE 1: For this material “weight%” means “ppm × 10⁻⁴”.

NOTE 2: For this material the phase fractions are calculated in volume percent (vol%).

NOTE 3: The baseline values for this material are mainly taken from those for *MAT_244. They are provided to give reasonable starting results. These values may not reproduce the results from the papers by Hippchen.

Card Summary:

Card 1. This card is required.

MID	RO	E	PR	TUNIT	TRIP	PHASE	HEAT
-----	----	---	----	-------	------	-------	------

Card 2. This card is required.

LCY1	LCY2	LCY3	LCY4	LCY5	C_F	C_P	C_B
------	------	------	------	------	-----	-----	-----

Card 3. This card is required.

C	Co	Mo	Cr	Ni	Mn	Si	V
---	----	----	----	----	----	----	---

Card 4. This card is required.

W	Cu	P	Al	As	Ti	B	
---	----	---	----	----	----	---	--

Card 5. This card is required.

		TABRHO		TREF	LAT1	LAT5	TABTH
--	--	--------	--	------	------	------	-------

Card 6. This card is required.

QR2	QR3	QR4	ALPHA	GRAIN	TOFFE	TOFPE	TOFBA
-----	-----	-----	-------	-------	-------	-------	-------

Card 7. This card is required.

PLMEM2	PLMEM3	PLMEM4	PLMEM5	STRC	STRP		
--------	--------	--------	--------	------	------	--	--

Card 8. This card is required.

FS	PS	BS	MS	MSIG	LCEPS23	LCEPS4	LCEPS5
----	----	----	----	------	---------	--------	--------

Card 9. This card is required.

LCH4	LCH5	DTCRIT	TSAMP	ISLC	IEXTRA		
------	------	--------	-------	------	--------	--	--

Card 10. This card is required.

ALPH_M	N_M	PHI_M	PSI_M	OMG_F	PHI_F	PSI_F	CR_F
--------	-----	-------	-------	-------	-------	-------	------

Card 11. This card is required.

OMG_P	PHI_P	PSI_P	CR_P	OMG_B	PHI_B	PSI_B	CR_B
-------	-------	-------	------	-------	-------	-------	------

Card 12. This card is included if HEAT \neq 0.

AUST	FERR	PEAR	BAIN	MART	GRK	GRQR	TAU1
------	------	------	------	------	-----	------	------

Card 13. This card is included if HEAT \neq 0.

GRA	GRB	EXPA	EXPB	GRCC	GRCM	HEATN	TAU2
-----	-----	------	------	------	------	-------	------

Card 14. This card is included if IEXTRA \geq 1.

FUNCA	FUNCB	FUNCM	TCVUP	TCVLO	CVCRT	TCVSL	
-------	-------	-------	-------	-------	-------	-------	--

Card 15. This card is included if IEXTRA \geq 2.

EPSP	EXPON						
------	-------	--	--	--	--	--	--

Data Card Definitions:

Card 1	1	2	3	4	5	6	7	8
Variable	MID	RO	E	PR	TUNIT	TRIP	PHASE	HEAT
Type	A	F	F	F	F	I	I	I
Defaults	none	none	none	none	3600	0	0	0

<u>VARIABLE</u>	<u>DESCRIPTION</u>	<u>BASELINE VALUE</u>
MID	Material identification. A unique number or label must be specified (see *PART).	
RO	Material density at room temperature (necessary for calculating transformation induced strains)	7830 Kg/m ³
E	Youngs' modulus: GT.0.0: Constant value is used. LT.0.0: Temperature dependent Young's modulus given by load curve or table ID = -E. The table input is described in Remark 10 .	100.e+09 Pa [1]
PR	Poisson's ratio: GT.0.0: Constant value is used. LT.0.0: Temperature dependent Poisson's ratio given by load curve or table ID = -PR. The table input is described in Remark 10 .	0.30 [1]
TUNIT	Number of time units per hour. Default is seconds, that is, 3600 time units per hour. It is used only for hardness calculations.	3600.
TRIP	Flag to activate (0) or deactivate (1) trip effect calculation	0

VARIABLE	DESCRIPTION	BASELINE VALUE
PHASE	Switch to exclude middle phases from the simulation: EQ.0: All phases active (default) EQ.1: Pearlite and bainite active EQ.2: Bainite active EQ.3: Ferrite and pearlite active EQ.4: Ferrite and bainite active EQ.5: No active middle phases (only austenite → martensite)	0
HEAT	Heat flag as in MAT_244: EQ.0: Heating is not activated. EQ.1: Heating is activated. EQ.2: Automatic switching between cooling and heating LT.0: Switch between cooling and heating is defined by a time dependent load curve with ID HEAT .	

Card 2	1	2	3	4	5	6	7	8
Variable	LCY1	LCY2	LCY3	LCY4	LCY5	C_F	C_P	C_B
Type	I	I	I	I	I	F	F	F
Defaults	none	none	none	none	none	0.0	0.0	0.0

VARIABLE	DESCRIPTION	BASELINE VALUE
LCY1	Load curve or table ID for austenite hardening.	

VARIABLE	DESCRIPTION	BASELINE VALUE
	<p>Load Curve. When LCY1 is a load curve ID, it defines input yield stress as a function of effective plastic strain.</p> <p>Tabular Data (LCY1 > 0). When LCY1 is greater than 0 and references a table ID, a 2D table references for each temperature value a hardening curve.</p> <p>Tabular Data (LCY1 < 0). When LCY1 is less than 0, LCY1 is a 3D table ID. Each input temperature value gives a table ID which defines for each a strain rate a hardening curve.</p>	
LCY2	Load curve or table ID for ferrite. See LCY1 for description.	
LCY3	Load curve or table ID for pearlite. See LCY1 for description.	
LCY4	Load curve or table ID for bainite. See LCY1 for description.	
LCY5	Load curve or table ID for martensite. See LCY1 for description.	
C_F	Alloy dependent factor C_f for ferrite (controls the alloying effects beside of Boron on the time-temperature-transformation start line of ferrite)	
C_P	Alloy dependent factor C_p for pearlite (see C_F for description)	
C_B	Alloy dependent factor C_b for bainite (see C_F for description)	

Card 3	1	2	3	4	5	6	7	8
Variable	C	Co	Mo	Cr	Ni	Mn	Si	V
Type	F	F	F	F	F	F	F	F
Defaults	0.0	0.0	0.0	0.0	0.0	0.0	0.0	0.0

VARIABLE	DESCRIPTION	BASELINE VALUE
C	Carbon [weight %]	0.23 [2]
Co	Cobolt [weight %]	0.0 [2]
Mo	Molybdenum [weight %]	0.0 [2]
Cr	Chromium [weight %]	0.21 [2]
Ni	Nickel [weight %]	0.0 [2]
Mn	Manganese [weight %]	1.25 [2]
Si	Silicon [weight %]	0.29 [2]
V	Vanadium [weight %]	0.0 [2]

Card 4	1	2	3	4	5	6	7	8
Variable	W	Cu	P	Al	As	Ti	B	
Type	F	F	F	F	F	F	F	
Defaults	0.0	0.0	0.0	0.0	0.0	0.0	0.0	

VARIABLE	DESCRIPTION	BASELINE VALUE
W	Tungsten [weight %]	0.0 [2]
Cu	Copper [weight %]	0.0 [2]

VARIABLE	DESCRIPTION	BASELINE VALUE
P	Phosphorous [weight %]	0.013 [2]
Al	Aluminum [weight %]	0.0 [2]
As	Arsenic [weight %]	0.0 [2]
Ti	Titanium [weight %]	0.0 [2]
B	Boron [weight %]	0.0

Card 5	1	2	3	4	5	6	7	8
Variable			TABRHO		TREF	LAT1	LAT5	TABTH
Type			I		F	F	F	I
Defaults			none		none	0.0	0.0	none

VARIABLE	DESCRIPTION	BASELINE VALUE
TABRHO	Table definition for phase and temperature dependent densities. Needed for calculation of transformation induced strains.	
TREF	Reference temperature for thermal expansion (only necessary for thermal expansion calculation with the secant method).	293.15
LAT1	Latent heat for the decomposition of austenite into ferrite, pearlite and bainite. GT.0.0: Constant value LT.0.0: Curve ID or table ID. See Remark 11 for more information.	$590 \times 10^6 \text{ J/m}^3$ [2]

VARIABLE	DESCRIPTION	BASELINE VALUE
LAT5	<p>Latent heat for the decomposition of austenite into martensite.</p> <p>GT.0.0: Constant value</p> <p>LT.0.0: Curve ID. Note that LAT 5 is ignored if a table ID is used in LAT1.</p>	$640 \times 10^6 \text{ J/m}^3$ [2]
TABTH	<p>Table definition for thermal expansion coefficient. See Remark 12.</p> <p>GT.0: A table for instantaneous thermal expansion (TREF is ignored)</p> <p>LT.0: A table with thermal expansion with reference to TREF</p>	

Card 6	1	2	3	4	5	6	7	8
Variable	QR2	QR3	QR4	ALPHA	GRAIN	TOFFE	TOFPE	TOFBA
Type	F	F	F	F	F	F	F	F
Defaults	0.0	0.0	0.0	0.0	0.0	0.0	0.0	0.0

VARIABLE	DESCRIPTION	BASELINE VALUE
QR2	<p>Activation energy divided by the universal gas constant for the diffusion reaction of the austenite-ferrite reaction: $Q2/R$. $R = 8.314472 \text{ [J/mol K]}$. Load curve ID if ISLC = 2 on Card 9 (function of cooling rate).</p>	$10324 \text{ K [3]} = (23000 \text{ cal/mole}) \times (4.184 \text{ J/cal}) / (8.314 \text{ J/mole/K})$
QR3	<p>Activation energy divided by the universal gas constant for the diffusion reaction for the austenite-pearlite reaction: $Q3/R$. $R = 8.314472 \text{ [J/mol K]}$. Load curve ID if ISLC = 2 on Card 9 (function of cooling rate).</p>	$13432. \text{ K [3]}$

VARIABLE	DESCRIPTION	BASELINE VALUE
QR4	Activation energy divided by the universal gas constant for the diffusion reaction for the austenite-bainite reaction: $Q4/R$. $R = 8.314472$ [J/mol K]. Load curve ID if ISLC = 2 on Card 9 (function of cooling rate).	15068. K [3]
ALPHA	Material constant for the martensite phase. A value of 0.011 means that 90% of the available austenite is transformed into martensite at 210 degrees below the martensite start temperature (see messag file for information), whereas a value of 0.033 means a 99.9% transformation.	0.011
GRAIN	ASTM grain size number G for austenite, usually a number between 7 and 11.	6.8
TOFFE	Number of degrees that the ferrite is bleeding over into the pearlite reaction: $T_{off,f}$	0.0
TOFPE	Number of degrees that the pearlite is bleeding over into the bainite reaction: $T_{off,p}$	0.0
TOFBA	Number of degrees that the bainite is bleeding over into the martensite reaction: $T_{off,b}$	0.0

Card 7	1	2	3	4	5	6	7	8
Variable	PLMEM2	PLMEM3	PLMEM4	PLMEM5	STRC	STRP		
Type	F	F	F	F	F	F		
Defaults	0.0	0.0	0.0	0.0	0.0	0.0		

VARIABLE	DESCRIPTION	BASELINE VALUE
PLMEM2	Memory coefficient for the plastic strain that is carried over from the austenite. A value of 1 means that all plastic strains from austenite is transferred to the ferrite phase and a value of 0 means that nothing is transferred.	0.0
PLMEM3	Same as PLMEM2 but between austenite and pearlite	0.0
PLMEM4	Same as PLMEM2 but between austenite and bainite	0.0
PLMEM5	Same as PLMEM3 but between austenite and martensite	0.0
STRC	Cowper and Symonds strain rate parameter <i>C</i> LT.0.0: Load curve ID = -STRC GT.0.0: Constant value EQ.0.0: Strain rate <i>not</i> active	0.0
STRP	Cowper and Symonds strain rate parameter <i>P</i> LT.0.0: Load curve ID = -STRP GT.0.0: Constant value EQ.0.0: Strain rate <i>not</i> active	0.0

Card 8	1	2	3	4	5	6	7	8
Variable	FS	PS	BS	MS	MSIG	LCEPS23	LCEPS4	LCEPS5
Type	F	F	F	F	F	I	I	I
Defaults	0.0	0.0	0.0	0.0	none	none	none	none

VARIABLE	DESCRIPTION	BASELINE VALUE
FS	<p>Manual start temperature ferrite, F_S.</p> <p>GT.0.0: Same temperature is used for heating and cooling.</p> <p>LT.0.0: Different start temperatures for cooling and heating given by load curve ID = -FS. First ordinate value is used for cooling, last ordinate value for heating.</p>	
PS	Manual start temperature pearlite, P_S . See FS for description.	
BS	Manual start temperature bainite, B_S . See FS for description.	
MS	Manual start temperature martensite, M_S . See FS for description.	
MSIG	<p>Describes the increase of martensite start temperature for cooling due to applied stress.</p> <p>LT.0: Load curve ID describes MSIG as a function of triaxiality (pressure / effective stress).</p> $MS^* = MS + MSIG \times \sigma_{eff}$	
LCEPS23	<p>Load curve ID dependent on plastic strain that scales the activation energy QR2 and QR3.</p> $QRn = Qn \times LCEPS23(\varepsilon_{pl})/R$	
LCEPS4	<p>Load curve ID dependent on plastic strain that scales the activation energy QR4.</p> $QR4 = Q4 \times LCEPS4(\varepsilon_{pl})/R$	
LCEPS5	<p>Load Curve ID which describe the increase of the martensite start temperature for cooling as a function of plastic strain.</p> $MS^* = MS + MSIG \times \sigma_{eff} + LCEPS5(\varepsilon_{pl})$	

Card 9	1	2	3	4	5	6	7	8
Variable	LCH4	LCH5	DTCRIT	TSAMP	ISLC	IEXTRA		
Type	I	I	F	F	I	I		
Defaults	0	0	0.0	0.0	0	0		

VARIABLE	DESCRIPTION	BASELINE VALUE
LCH4	Load curve ID of Vickers hardness as a function of temperature for bainite hardness calculation	
LCH5	Load curve ID of Vickers hardness as a function of temperature for martensite hardness calculation	
DTCRIT	Critical cooling rate to detect holding phase	
TSAMP	Sampling interval for temperature rate monitoring to detect the holding phase	
ISLC	<p>Flag for definition of evolution parameters on Cards 10 and 11.</p> <p>EQ.0.0: All 16 fields on Cards 10 and 11 are constant values.</p> <p>EQ.1.0: PHI_F, CR_F, PHI_P, CR_P, PHI_B, and CR_B are load curves defining values as functions of cooling rate. The remaining 10 fields on Cards 10 and 11 are constant values.</p> <p>EQ.2.0: QR2, QR3, and QR4 from Card 6 and all 16 fields on Cards 10 and 11 are load curves defining values as functions of cooling rate.</p>	
IEXTRA	Flag to read extra cards (see Cards 14 and 15)	

Card 10	1	2	3	4	5	6	7	8
Variable	ALPH_M	N_M	PHI_M	PSI_M	OMG_F	PHI_F	PSI_F	CR_F
Type	F	F	F	F	F	F	F	F
Defaults	0.0428	0.191	0.382	2.421	0.41	0.4	0.4	0.0

VARIABLE	DESCRIPTION	BASELINE VALUE
ALPH_M	Martensite evolution parameter α_m	0.0428
N_M	Martensite evolution parameter n_m	0.191
PHI_M	Martensite evolution parameter φ_m	0.382
PSI_M	Martensite evolution exponent ψ_m . If $\psi_m < 0$, then $\psi_m = \psi_m (2 - \zeta_a)$.	2.421
OMG_F	Ferrite grain size factor ω_f (mainly controls the alloying effect of Boron on the time-temperature-transformation start line of ferrite)	0.41
PHI_F	Ferrite evolution parameter φ_f (controls the incubation time till 1 vol% of ferrite is built)	0.4
PSI_F	Ferrite evolution parameter ψ_f (controls the time till 99 vol% of ferrite is built without effect on the incubation time)	0.4
CR_F	Ferrite evolution parameter $C_{r,f}$ (retardation coefficient to influence the kinetics of phase transformation of ferrite, should be determined at slow cooling conditions, can also be defined in dependency to the cooling rate)	0.0

Card 11	1	2	3	4	5	6	7	8
Variable	OMG_P	PHI_P	PSI_P	CR_P	OMG_B	PHI_B	PSI_B	CR_B
Type	F	F	F	F	F	F	F	F
Defaults	0.32	0.4	0.4	0.0	0.29	0.4	0.4	0.0

VARIABLE	DESCRIPTION	BASELINE VALUE
OMG_P	Pearlite grain size factor ω_p (see OMG_F for description)	0.32
PHI_P	Pearlite evolution parameter φ_p (see PHI_F for description)	0.4
PSI_P	Pearlite evolution parameter ψ_p (see PSI_F for description)	0.4
CR_P	Pearlite evolution parameter $C_{r,p}$ (see CR_F for description)	0.0
OMG_B	Bainite grain size factor ω_b (see OMG_F for description)	0.32
PHI_B	Bainite evolution parameter φ_b (see PHI_F for description)	0.4
PSI_B	Bainite evolution parameter ψ_b (see PSI_F for description)	0.4
CR_B	Bainite evolution parameter $C_{r,b}$ (see CR_F for description)	0.0

Heat Card 1. Additional Card for HEAT \neq 0.

Card 12	1	2	3	4	5	6	7	8
Variable	AUST	FERR	PEAR	BAIN	MART	GRK	GRQR	TAU1
Type	F	F	F	F	F	F	F	F
Default	0.0	0.0	0.0	0.0	0.0	0.0	0.0	2.08E+8

<u>VARIABLE</u>	<u>DESCRIPTION</u>	<u>BASELINE VALUE</u>
AUST	If a heating process is initiated at $t = 0$, this field sets the initial amount of austenite in the blank. If heating is activated at $t > 0$ during a simulation, this value is ignored. Note that, $\text{AUST} + \text{FERR} + \text{PEAR} + \text{BAIN} + \text{MART} = 1.0$	0.0
FERR	See AUST for description	0.0
PEAR	See AUST for description	0.0
BAIN	See AUST for description	0.0
MART	See AUST for description	0.0
GRK	Growth parameter k ($\mu\text{m}^2/\text{sec}$)	10^{11} [9]
GRQR	Grain growth activation energy (J/mol) divided by the universal gas constant: Q/R . $R = 8.314472$ (J/mol K)	3.0×10^4 [9]
TAU1	Empirical grain growth parameter c_1 describing the function $\tau(T)$	2.08×10^8 [9]

Heat Card 2. Additional Card for HEAT \neq 0.

Card 13	1	2	3	4	5	6	7	8
Variable	GRA	GRB	EXPA	EXPB	GRCC	GRCM	HEATN	TAU2
Type	F	F	F	F	F	F	F	F
Default	3.11	7520.	1.0	1.0	none	none	1.0	4.806

VARIABLE	DESCRIPTION	BASELINE VALUE
GRA	Grain growth parameter <i>A</i>	[9]
GRB	Grain growth parameter <i>B</i> . A table of recommended values of GRA and GRB is included in Remark 8 of *MAT_244.	[9]
EXPA	Grain growth parameter <i>a</i>	1.0 [9]
EXPB	Grain growth parameter <i>b</i>	1.0 [9]
GRCC	Grain growth parameter with the concentration of nonmetals in the blank, weight% of C or N	[9]
GRCM	Grain growth parameter with the concentration of metals in the blank, lowest weight% of Cr, V, Nb, Ti, Al	[9]
HEATN	Grain growth parameter <i>n</i> for the austenite formation	1.0 [9]
TAU2	Empirical grain growth parameter c_2 describing the function $\tau(T)$	4.806 [9]

Extra Card 1. Additional Card for IEXTRA ≥ 1

Card 14	1	2	3	4	5	6	7	8
Variable	FUNCA	FUNCB	FUNCM	TCVUP	TCVLO	CVCRIT	TCVSL	
Type	F	F	F	F	F	F	F	
Default	0.0	0.0	0.0	0.0	0.0	0.0	0.0	

<u>VARIABLE</u>	<u>DESCRIPTION</u>	<u>BASELINE VALUE</u>
FUNCA	ID of a *DEFINE_FUNCTION for saturation stress <i>A</i> (Hockett-Sherby approach)	
FUNCB	ID of a *DEFINE_FUNCTION for initial yield stress <i>B</i> (Hockett-Sherby approach)	
FUNCM	ID of a *DEFINE_FUNCTION for saturation rate <i>M</i> (Hockett-Sherby approach)	
TCVUP	Upper temperature for determination of average cooling velocity	
TCVLO	Lower temperature for determination of average cooling velocity	
CVCRIT	Critical cooling velocity. If the average cooling velocity is less than or equal to CVCRIT, the cooling rate at temperature TCVSL is used.	
TCVSL	Temperature for determination of cooling velocity for small cooling velocities.	

Extra Card 2. Additional Card for IEXTRA ≥ 2

Card 15	1	2	3	4	5	6	7	8
Variable	EPSP	EXPON						
Type	F	F						
Default	0.0	0.0						

VARIABLE	DESCRIPTION	BASELINE VALUE
EPSP	Plastic strain in Hockett-Sherby approach	
EXPON	Exponent in Hockett-Sherby approach	

Remarks:

- Start Temperatures.** Start temperatures for ferrite, pearlite, bainite, and martensite can be defined manually using FS, PS, BS, and MS. Or they are initially defined using the following composition equations:

$$F_S = 273.15 + 912 - 203 \times \sqrt{C} - 15.2 \times \text{Ni} + 44.7 \times \text{Si} + 104 \times \text{V} + 31.5 \times \text{Mo} + 13.1 \times \text{W} - 30 \times \text{Mn} - 11 \times \text{Cr} - 20 \times \text{Cu} + 700 \times \text{P} + 400 \times \text{Al} + 120 \times \text{As} + 400$$

$$P_S = 273.15 + 723 - 10.7 \times \text{Mn} - 16.9 \times \text{Ni} + 29 \times \text{Si} + 16.9 \times \text{Cr} + 290 \times \text{As} + 6.4 \times \text{W}$$

$$B_S = 273.15 + 637 - 58 \times \text{C} - 35 \times \text{Mn} - 15 \times \text{Ni} - 34 \times \text{Cr} - 41 \times \text{Mo}$$

$$M_S = 273.15 + 539 - 423 \times \text{C} - 30.4 \times \text{Mn} - 17.7 \times \text{Ni} - 12.1 \times \text{Cr} - 7.5 \times \text{Mo} + 10 \times \text{Co} - 7.5 \times \text{Si}$$

- Martensite Phase Evolution.** Martensite phase evolution according to Lee et al. [2008, 2010] if PSI_M > 0:

$$\frac{d\zeta_m}{dT} = \alpha_m (M_S - T)^n \zeta_m^{\varphi_m} (1 - \zeta_m)^{\psi_m}$$

Martensite phase evolution according to Lee et al. [2008, 2010] with extension by Hippchen et al. [2013] if PSI_M < 0:

$$\frac{d\zeta_m}{dT} = \alpha_m (M_S - T)^n \zeta_m^{\varphi_m} (1 - \zeta_m)^{\psi_m(2-\zeta_a)}$$

3. Phase Change Kinetics for Ferrite, Pearlite and Bainite.

$$\frac{d\zeta_f}{dt} = 2^{\omega_f G} \frac{\exp\left(-\frac{Q_f}{RT}\right)}{C_f} (F_S - T)^3 \frac{\zeta^{\varphi_f(1-\zeta_f)} (1 - \zeta_f)^{\psi_f \zeta_f}}{\exp(C_{r,f} \zeta_f^2)}$$

$$\text{for } F_S \geq T \geq (P_S - T_{\text{off},f})$$

$$\frac{d\zeta_p}{dt} = 2^{\omega_p G} \frac{\exp\left(-\frac{Q_p}{RT}\right)}{C_p} (P_S - T)^3 \frac{\zeta^{\varphi_p(1-\zeta_p)} (1 - \zeta_p)^{\psi_p \zeta_p}}{\exp(C_{r,p} \zeta_p^2)}$$

$$\text{for } P_S \geq T \geq (B_S - T_{\text{off},p})$$

$$\frac{d\zeta_b}{dt} = 2^{\omega_b G} \frac{\exp\left(-\frac{Q_b}{RT}\right)}{C_b} (B_S - T)^2 \frac{\zeta^{\varphi_b(1-\zeta_b)} (1 - \zeta_b)^{\psi_b \zeta_b}}{\exp(C_{r,b} \zeta_b^2)}$$

$$\text{for } M_S \geq T \geq (M_S - T_{\text{off},b})$$

4. **History Variables.** History variables of this material model are listed in the following table. To be able to post-process that data, parameters NEIPS (shells) or NEIPH (solids) must be defined on *DATABASE_EXTENT_BINARY.

History Variable	Description
1	Amount austenite
2	Amount ferrite
3	Amount pearlite
4	Amount bainite
5	Amount martensite
6	Vickers hardness
7	Yield stress
8	ASTM grain size number
9	Young's modulus
10	Saturation stress A (H-S approach)
11	Initial yield stress B (H-S approach)
12	Saturation rate M (H-S approach)
13	Yield stress of H-S approach $\sigma_y = A - (A - B) \times e^{-M \times \text{EPS}^{\text{EXPON}}}$
17	Temperature rate

History Variable	Description
19	Current temperature
25	Plastic strain rate
26	Effective thermal expansion coefficient

- Choosing/Excluding Phases.** To exclude a phase from the simulation, set the PHASE parameter accordingly.
- Strain Rate Effects.** Note that both strain rate parameters (STRC and STRP) must be set to include the effect. It is possible to use a temperature dependent load curve for both parameters simultaneously or for one parameter keeping the other constant.
- Time Units.** TUNIT is time units per hour and is only used for calculating the Vicker Hardness. By default, it is assumed that the time unit is seconds. If another time unit is used, for example milliseconds, then TUNIT must be changed to $TUNIT = 3.6 \times 10^6$.
- Thermal Speedup Factor.** The thermal speedup factor TSF of *CONTROL_THERMAL_SOLVER is used to scale reaction kinetics and hardness calculations in this material model. Strain rate dependent properties (see LCY1 to LCY5 or STRC/STRP), however, are not scaled by TSF.
- Re-Austenization and Grain Growth with the HEAT Field.** When HEAT is activated, the re-austenitization and grain growth algorithms are also activated. See Remark 8 of MAT_244 for details.
- Phase Indexed Tables.** When using a table ID to describe the Young's modulus as dependent on the temperature, use *DEFINE_TABLE_2D. Set the abscissa value equal to 1 for the austenite YM-curve, equal to 2 for the ferrite YM-curve, equal to 3 for the pearlite YM curve, equal to 4 for the bainite YM-curve and finally equal to 5 for the martensite YM-curve. When using the PHASE option only the curves for the included phases are required, but all five phases may be included. The total YM is calculated by a linear mixture law:

$$YM = YM1 \times PHASE1 + \dots + YM5 \times PHASE5$$

For example:

```
*DEFINE_TABLE_2D
$ The number before curve id:s define which phase the curve
$ will be applied to. 1 = Austenite, 2 = Ferrite, 3 = Pearlite,
$ 4 = Bainite and 5 = Martensite.
1000      0.0      0.0
           1.0           100
           2.0           200
           3.0           300
```

```

          4.0          400
          5.0          500
$
$ Define curves 100 - 500
*DEFINE_CURVE
$ Austenite Temp (K) - YM-Curve (MPa)
    100          0          1.0          1.0
    1300.0      50.E+3
    223.0      210.E+3
```

- 11. **Phase-indexed Latent Heat Table.** A table ID may be specified for the Latent heat (LAT1) to describe each phase change individually. Use *DEFINE_TABLE_2D and set the abscissa values to the corresponding phase transition number. That is, 2 for the Austenite – Ferrite, 3 for the Austenite – Pearlite, 4 for the Austenite – Bainite and 5 for the Austenite – Martensite. See [Remark 10](#) for an example of a correct table definition. If a curve is missing, the corresponding latent heat for that transition will be set to zero. Also, when a table is used, LAT2 is ignored. If HEAT > 0, the latent for the transition back to Austenite can also be included. This latent heat curve is marked as 1 in the table definition of LAT1.
- 12. **Phase-indexed Thermal Expansion Table.** Tables are supported for defining different thermal expansion properties for each phase. The input is identical to the above table definitions. The table must have the abscissa values between 1 and 5 where the number correspond to phase 1 to 5. To exclude one phase from influencing the thermal expansion you simply input a curve that is zero for that phase or even easier, exclude that phase number in the table definition. For example, to exclude the bainite phase you only define the table with curves for the indices 1, 2, 3 and 5.
- 13. **Phase-indexed Transformation Induced Strain Properties.** Transformation induced strains can be define with a table TABRHO, where densities are defined as functions of phase (table abscissas) and temperature (load curves).

***MAT_REINFORCED_THERMOPLASTIC**

This is Material Type 249. This material model describes a reinforced thermoplastic composite material. The reinforcement is defined as an anisotropic hyper-elastic material with up to three distinct fiber directions. It can be used to model unidirectional layers as well as woven and non-crimped fabrics. The matrix is modeled with a simple thermal elasto-plastic material formulation. For a composite, the overall stress is found by adding the fiber and matrix stresses.

Card Summary:

Card 1. This card is required.

MID	RO	EM	LCEM	PRM	LCPRM	LCSIGY	BETA
-----	----	----	------	-----	-------	--------	------

Card 2. This card is required.

NFIB	AOPT				A1	A2	A3
------	------	--	--	--	----	----	----

Card 3. This card is required.

V1	V2	V3	D1	D2	D3	MANGL	THICK
----	----	----	----	----	----	-------	-------

Card 4. This card is required.

IDF1	ALPH1	EF1	LCEF1	G23_1	G31_1		
------	-------	-----	-------	-------	-------	--	--

Card 5. This card is required.

G12	LCG12	ALOC12	GLOC12	METH12			
-----	-------	--------	--------	--------	--	--	--

Card 6. This card is required.

IDF2	ALPH2	EF2	LCEF2	G23_2	G31_2		
------	-------	-----	-------	-------	-------	--	--

Card 7. This card is required.

G23	LCG23	ALOC23	GLOC23	METH23			
-----	-------	--------	--------	--------	--	--	--

Card 8. This card is required.

IDF3	ALPH3	EF3	LCEF3	G23_3	G31_3		
------	-------	-----	-------	-------	-------	--	--

Card 9. This card is optional.

POSTV	IHIS						
-------	------	--	--	--	--	--	--

Data Card Definitions:

Card 1	1	2	3	4	5	6	7	8
Variable	MID	RO	EM	LCEM	PRM	LCPRM	LCSIGY	BETA
Type	A	F	F	I	F	I	I	F

VARIABLE**DESCRIPTION**

MID	Material identification. A unique number or label must be specified (see *PART).
RO	Density
EM	Young's modulus of matrix material
LCEM	Curve ID for Young's modulus of matrix material as a function of temperature. With this option active, EM is ignored.
PR	Poisson's ratio for matrix material
LCPR	Curve ID for Poisson's ratio of matrix material versus temperature. With this option active, PR is ignored.
LCSIGY	Load curve or table ID for strain hardening of the matrix. If a curve, then it specifies yield stress as a function of effective plastic strain. If a table, then temperatures are the table values indexing curves giving yield stress as a function of effective plastic strain (see *DEFINE_TABLE).
BETA	Parameter for mixed hardening, $0.0 \leq \beta \leq 1.0$. Set $\beta = 0.0$ for pure kinematic hardening and $\beta = 1.0$ for pure isotropic hardening.

Card 2	1	2	3	4	5	6	7	8
Variable	NFIB	AOPT				A1	A2	A3
Type	I	F				F	F	F

VARIABLE**DESCRIPTION**

NFIB	Number of fiber families to be considered
------	---

VARIABLE**DESCRIPTION**

AOPT

Material axes option (see `MAT_OPTIONTROPIC_ELASTIC` for a more complete description):

EQ.0.0: Locally orthotropic with material axes determined by element nodes, as with `*DEFINE_COORDINATE_NODES`, and then rotated about the shell element normal by the angle `MANGL`.

EQ.2.0: Globally orthotropic with material axes determined by vectors defined below, as with `*DEFINE_COORDINATE_VECTOR`.

EQ.3.0: Locally orthotropic material axes determined by a vector \mathbf{v} and the normal vector to the plane of the element. \mathbf{a} is determined by taking the cross product of \mathbf{v} with the normal vector, \mathbf{b} is determined by taking the cross product of the normal vector with \mathbf{a} , and \mathbf{c} is the normal vector. Then \mathbf{a} and \mathbf{b} are rotated about \mathbf{c} by an angle. The angle may be set in the keyword input for the element or in the input for this keyword with `MANGL`.

LT.0.0: The absolute value of `AOPT` is a coordinate system ID number (`CID` on `*DEFINE_COORDINATE_NODES`, `*DEFINE_COORDINATE_SYSTEM` or `*DEFINE_COORDINATE_VECTOR`).

A1, A2, A3

Components of vector \mathbf{a} for `AOPT = 2`.

Card 3	1	2	3	4	5	6	7	8
Variable	V1	V2	V3	D1	D2	D3	MANGL	THICK
Type	F	F	F	F	F	F	F	F

VARIABLE**DESCRIPTION**

V1, V2, V3

Components of vector \mathbf{v} for `AOPT = 3`

D1, D2, D3

Components of vector \mathbf{d} for `AOPT = 2`

MANGL

Material angle in degrees for `AOPT = 0` and `3`. It may be overwritten on the element card; see `*ELEMENT_SHELL_BETA`.

VARIABLE **DESCRIPTION**

THICK Balance thickness changes of the material due to the matrix description by scaling fiber stresses
 EQ.0: No scaling
 EQ.1: Scaling

Card 4	1	2	3	4	5	6	7	8
Variable	IDF1	ALPH1	EF1	LCEF1	G23_1	G31_1		
Type	I	F	F	I	F	F		

VARIABLE **DESCRIPTION**

IDF1 ID for 1st fiber family for post-processing

ALPH1 Orientation angle α_1 for 1st fiber with respect to overall material direction

EF1 Young’s modulus for 1st fiber family

LCEF1 Load curve for stress as a function of fiber strain of 1st fiber. With this option active, EF1 is ignored. If a curve, then it specifies input stress as a function of fiber strain. If a table, then temperatures are the table values indexing curves giving stress as function of fiber strain. The table data will be extrapolated for both strains and temperatures where necessary.

G23_1 Transverse shear modulus orthogonal to direction of 1st fiber

G31_1 Transverse shear modulus in direction of 1st fiber

Card 5	1	2	3	4	5	6	7	8
Variable	G12	LCG12	ALOC12	GLOC12	METH12			
Type	F	I	F	F	I			

VARIABLE	DESCRIPTION
G12	Linear shear modulus for shearing between fiber families 1 and 2
LCG12	Curve ID for shear stress as a function of shearing type as specified with METH12 between the 1 st and 2 nd fibers. See Remark 1 .
ALOC12	Locking angle (in radians) for shear between fiber families 1 and 2
GLOC12	Linear shear modulus for shear angles larger than ALOC12
METH12	Option for shear response between fiber 1 and 2 (see Remark 1): EQ.0: Elastic shear response. Curve LCG12 specifies shear stress as a function of the scalar product of the fiber directions. EQ.1: Elasto-plastic shear response. Curve LCG12 specifies yield shear stress as a function of the normalized scalar product of the fiber directions. EQ.2: Elastic shear response. Curve LCG12 specifies shear stress as a function of shear angle (radians) between the fibers. EQ.3: Elasto-plastic shear response. Curve LCG12 defines yield shear stress as a function of normalized shear angle between the fibers. EQ.4: Elastic shear response. Curve LCG12 specifies shear stress as a function of shear angle (radians) between the fibers. This option is a special implementation for non-crimped fabrics, where one of the fiber families corresponds to a stitching. EQ.5: Elasto-plastic shear response. Curve LCG12 specifies yield shear stress as a function of normalized shear angle between the fibers. This option is a special implementation for non-crimped fabrics, where one of the fiber families corresponds to a stitching. EQ.10: Elastic shear response. Curve LCG12 specifies shear stress as a function of shear angle (radians) between the fibers. This option is tailored for woven fabrics and guarantees a pure shear stress response. EQ.11: Elasto-plastic shear response. Curve LCG12 specifies yield shear stress as a function of normalized shear angle. This option is tailored for woven fabrics and guarantees a pure shear stress response.

Card 6	1	2	3	4	5	6	7	8
Variable	IDF2	ALPH2	EF2	LCEF2	G23_2	G31_2		
Type	I	F	F	I	F	F		

VARIABLE**DESCRIPTION**

IDF2	ID for 2 nd fiber family for post-processing
ALPH2	Orientation angle α_2 for 2 nd fiber with respect to overall material direction
EF2	Young's modulus for 2 nd fiber family
LCEF2	Load curve for stress as a function of fiber strain of 2 nd fiber. With this option active, EF2 is ignored. If a curve, then it specifies input stress as a function of fiber strain. If a table, then temperatures are the table values indexing curves giving stress as function of fiber strain. The table data will be extrapolated for both strains and temperatures where necessary.
G23_2	Transverse shear modulus orthogonal to direction of 2 nd fiber
G31_2	Transverse shear modulus in direction of 2 nd fiber

Card 7	1	2	3	4	5	6	7	8
Variable	G23	LCG23	ALOC23	GLOC23	METH23			
Type	F	I	F	F	I			

VARIABLE**DESCRIPTION**

G23	Linear shear modulus for shearing between fiber families 2 and 3
LCG23	Curve ID for shear stress as a function of shearing type as specifies with METH23 between the 2 nd and 3 rd fibers. See Remark 1 .
ALOC23	Locking angle (in radians) for shear between fiber families 2 and 3
GLOC23	Linear shear modulus for shear angles larger than ALOC23

VARIABLE**DESCRIPTION**

METH23

Option for shear response between fibers 2 and 3 (see METH12 for input options and [Remark 1](#)).

Card 8	1	2	3	4	5	6	7	8
Variable	IDF3	ALPH3	EF3	LCEF3	G23_3	G31_3		
Type	I	F	F	I	F	F		

VARIABLE**DESCRIPTION**

IDF3

ID for 3rd fiber family for post-processing

ALPH3

Orientation angle α_3 for 3rd fiber with respect to overall material direction

EF3

Young's modulus for 3rd fiber family

LCEF3

Load curve for stress versus fiber strain of 3rd fiber. With this option active, EF3 is ignored. If a curve, then it specifies input stress as a function of fiber strain. If a table, then temperatures are the table values indexing curves giving stress as function of fiber strain. The table data will be extrapolated for both strains and temperatures where necessary.

G23_3

Transverse shear modulus orthogonal to direction of 3rd fiber

G31_3

Transverse shear modulus in direction of 3rd fiber

This card is optional.

Card 9	1	2	3	4	5	6	7	8
Variable	POSTV	IHIS						
Type	I							

VARIABLE**DESCRIPTION**

POSTV

Defines additional history variables that might be useful for post-processing. See [Remark 2](#).

VARIABLE	DESCRIPTION
IHIS	<p>Flag for material properties initialization:</p> <p>EQ.0: Material properties defined in Cards 1 - 8 are used.</p> <p>GE.1: Use *INITIAL_STRESS_SHELL to initialize some material properties on an element-by-element basis (see Remark 3 below).</p>

Remarks:

1. **Stress Calculation.** This material features an additive split of the matrix and reinforcement contributions to the stress. Therefore, the combined stress response, σ , equals the sum $\sigma^m + \sigma^f$.

The matrix model uses an elastic-plastic material formulation with a von-Mises yield criterion. Material parameters, such as Young's modulus, Poisson's ratio and yield stress, can be given as functions of temperature. This material supports a mixed hardening approach.

We formulated the contribution of the fiber reinforcement as a hyperelastic material. Based on the orientation angle, α_i , of the i^{th} fiber family, LS-DYNA computes an initial fiber direction in the element coordinate system \mathbf{m}_i^0 . By using the deformation gradient, \mathbf{F} , the current fiber configuration is given as $\mathbf{m}_i = \mathbf{F} \mathbf{m}_i^0$, containing all necessary information on fiber strain and reorientation. Here, this vector is always orthogonal to the shell normal and can, thus, be represented by the two in-plane vector components.

Following standard textbook mechanics for anisotropic and hyperelastic materials, the elastic stresses within the fibers due to tension or compression are given as

$$\sigma_T^f = \sum_{i=1}^n \sigma_{T,i}^f(\lambda_i) = \sum_{i=1}^n \frac{1}{J} f_i(\lambda_i) (\mathbf{m}_i \otimes \mathbf{m}_i) ,$$

where the function f_i of the fiber strain λ_i corresponds to the load curve LCEFi. n is the number of fiber families.

The shear behavior of the reinforcement can be controlled by METHij. For values less than 10, the behavior is again standard textbook mechanics:

$$\sigma_S^f = \sum_{i=1}^{n-1} \sigma_{S,i,i+1}^f = \sum_{i=1}^{n-1} \frac{1}{J} g_{i,i+1}(\kappa_{i,i+1}) (\mathbf{m}_i \otimes \mathbf{m}_{i+1}) .$$

Here $\kappa_{i,i+1}$ represents the employed shear measure (scalar product or shear angle in radians). In general, the dyadic product $\mathbf{m}_i \otimes \mathbf{m}_{i+1}$ does not define a shear

stress tensor. This formulation might result in unphysical shear behavior in the case of woven fabrics. Therefore, we devised METH_{ij} = 10 and 11 to always give a pure shear stress tensor, σ_S^f .

For even values of METH_{ij}, an elastic shear response is assumed. If defined, the load curve LCG_{ij} corresponds to function $g_{i,j}$. In this case the values of G_{ij}, ALOC_{ij} and GLOC_{ij} are ignored.

For odd values of METH_{ij} on the other hand, an elasto-plastic shear behavior is assumed and the load curve LCG_{ij} defines the yield stress value as function of a normalized shear parameter. This implies that the load curve needs to be defined for abscissa values between 0.0 and 1.0. A first elastic regime, which is controlled by the linear shear stiffness G_{ij}, is assumed until the yield stress given in the load curve for normalized shear value 0.0 is reached. A second linear elastic regime is defined for shear angles (ξ_{ij}) / fiber angles (η_{ij}) larger than the locking angle ALOC_{ij}. The corresponding stiffness in that regime is GLOC_{ij}. At the transition point to the second elastic regime, the shear stress corresponds to the load curve value for a normalized shear of 1.0.

- History Data.** This material formulation outputs to d3plot additional data for post-processing to the set of history variables if requested. The parameter POSTV specifies the data to be written. Its value is calculated as

$$POSTV = a_1 + 2 a_2 + 4 a_3 + 8 a_4 + 16 a_5 + 32 a_6 + 64 a_7.$$

Each flag a_i is a binary number (can be either 1 or 0) and corresponds to one particular type of post-processing variable according to the following table.

Flag	Description	Variables	# History Var
a_1	Fiber angle	η_{12}, η_{23}	2
a_2	Fiber ID	IDF1, IDF2, IDF3	3
a_3	Fiber strain	$\lambda_1, \lambda_2, \lambda_3$	3
a_4	Fiber direction (in global coordinates)	$\mathbf{m}_1^g, \mathbf{m}_2^g, \mathbf{m}_3^g$	9
a_5	Individual fiber stresses	$f_1(\lambda_1), f_2(\lambda_2), f_3(\lambda_3)$	3
a_6	Fiber stress tensor	$\sigma_{11}^f, \sigma_{22}^f, \sigma_{33}^f, \sigma_{12}^f, \sigma_{23}^f, \sigma_{31}^f$	6
a_7	Fiber direction (in material coordinates)	$\mathbf{m}_1^m, \mathbf{m}_2^m, \mathbf{m}_3^m$	6

The above table also shows the order of output as well as the number of extra history variables associated with the particular flag. In total NXH extra variables are required depending on the choice of parameter POSTV. For example, the maximum number of additional variables is $NXH = 32$ for $POSTV = 127$.

As mentioned in [Remark 1](#) fiber orientation is represented in the material subroutine as vector \mathbf{m}_i defined in the element coordinate system. Prior to writing to the list of histories the vector is transformed into the global coordinate system with three vector components for $a_4 = 1$ and/or into the overall material coordinate system with two vector components for $a_7 = 1$.

A more complete list of potentially helpful history variables is given in the following table. The variable NEIPS in *DATABASE_EXTENT_BINARY must be set to output these history variables.

History Variable #	Description
3	Number of fibers
4	NXH
$5 \rightarrow NXH + 4$	Variables as described in preceding table
$NXH + 5$	POSTV
$NXH + 6, NXH + 7$	Shear angles ζ_{12} and ζ_{23}
$NXH + 8$	Matrix damage parameter d^m
$NXH + 9 \rightarrow NXH + 11$	Fiber tensile damage parameter $d_i^{f,t}$
$NXH + 12 \rightarrow NXH + 14$	Fiber compressive damage param. $d_i^{f,c}$
$NXH + 15 \rightarrow NXH + 20$	Matrix stress tensor in element coordinate system
$NXH+21 \rightarrow NXH + 26$	Deformation gradient

- Description of IHIS.** Some material data can be initialized on an element-by-element basis through history variables defined with *INITIAL_STRESS_SHELL starting at position HISV5.

How the data is interpreted depends on the parameter IHIS. Following the same concept as for parameter POSTV, the value of IHIS is computed by the following expression:

$$IHIS = a_1 + 2 a_2$$

Each flag a_i is a binary number (can be either 1 or 0) and corresponds to one particular type of material variable. So far, the only material variables implemented are fiber orientation in two different coordinate systems, global and material. Thus, at most one of the flags a_1 and a_2 should be set to 1.

Flag	Description	Variables	# History Var
a_1	Fiber direction (in global coordinates)	$\mathbf{m}_1^g, \mathbf{m}_2^g, \mathbf{m}_3^g$	9
a_2	Fiber direction (in material coordinates)	$\mathbf{m}_1^m, \mathbf{m}_2^m, \mathbf{m}_3^m$	6

*MAT_REINFORCED_THERMOPLASTIC_CRASH

This is Material Type 249. This material model describes a reinforced thermoplastic composite material with its damage and failure behavior. The reinforcement is modeled as an anisotropic hyper-elastic material with up to three distinguished fiber directions. It can be used to model unidirectional layers as well as woven and non-crimped fabrics. The matrix is modeled with a simple elastic plastic material formulation. For a composite, the overall stress is found by adding the fiber and matrix stresses.

Card Summary:

Card 1. This card is required.

MID	RO	EM	PRM	LCSIGY	BETA	PFL	VISC
-----	----	----	-----	--------	------	-----	------

Card 2. This card is required.

NFIB	AOPT				A1	A2	A3
------	------	--	--	--	----	----	----

Card 3. This card is required.

V1	V2	V3	D1	D2	D3	MANGL	THICK
----	----	----	----	----	----	-------	-------

Card 4. This card is included if VISC > 0.

VG1	VB1	VG2	VB2	VG3	VB3	VG4	VB4
-----	-----	-----	-----	-----	-----	-----	-----

Card 5. This card is required.

IDF1	ALPH1	EF1	LCEF1	G23_1	G31_1	DAF1	DAM1
------	-------	-----	-------	-------	-------	------	------

Card 6. This card is required.

G12	LCG12	ALOC12	GLOC12	METH12	DAM12		
-----	-------	--------	--------	--------	-------	--	--

Card 7. This card is required.

IDF2	ALPH2	EF2	LCEF2	G23_2	G31_2	DAF2	DAM2
------	-------	-----	-------	-------	-------	------	------

Card 8. This card is required.

G23	LCG23	ALOC23	GLOC23	METH23	DAM23		
-----	-------	--------	--------	--------	-------	--	--

Card 9. This card is required.

IDF3	ALPH3	EF3	LCEF3	G23_3	G31_3	DAF3	DAM3
------	-------	-----	-------	-------	-------	------	------

Card 10. This card is optional.

POSTV	VISCS	IHIS					
-------	-------	------	--	--	--	--	--

Data Card Definitions:

Card 1	1	2	3	4	5	6	7	8
Variable	MID	RO	EM	PRM	LCSIGY	BETA	PFL	VISC
Type	A	F	F	F	I	F	F	F

VARIABLE

DESCRIPTION

MID	Material identification. A unique number or label must be specified (see *PART).
RO	Mass density, ρ
N	Number of phases
EM	Young's modulus of matrix material
PRM	Poisson's ratio for matrix material
LCSIGY	Load curve or table ID for strain hardening of the matrix. If a curve, then it specifies yield stress as a function of effective plastic strain. If a table, then temperatures are the table values indexing curves giving yield stress as a function of effective plastic strain (see *DEFINE_TABLE).
BETA	Parameter for mixed hardening, $0.0 \leq \beta \leq 1.0$. Set $\beta = 0.0$ for pure kinematic hardening and $\beta = 1.0$ for pure isotropic hardening.
PFL	Percentage of layers that must fail to initiate failure of the element (default is 100)
VISC	Viscous formulation for fibers: EQ.0.0: Elastic behavior GE.1.0: Viscoelastic behavior modeled with a Prony series. See Remark 3 .

Card 2	1	2	3	4	5	6	7	8
Variable	NFIB	AOPT				A1	A2	A3
Type	I	F				F	F	F

VARIABLE

DESCRIPTION

- NFIB Number of fiber families to be considered (up to 3)
- AOPT Material axes option (see *MAT_OPTIONTROPIC_ELASTIC for a more complete description):
- EQ.0.0: Locally orthotropic with material axes determined by element nodes, as with *DEFINE_COORDINATE_NODES, and then rotated about the shell element normal by the angle MANGL.
 - EQ.2.0: Globally orthotropic with material axes determined by vectors defined below, as with *DEFINE_COORDINATE_VECTOR.
 - EQ.3.0: Locally orthotropic material axes determined by rotating the material axes about the element normal by an angle, MANGL, from a line in the plane of the element defined by the cross product of the vector v with the element normal
 - LT.0.0: The absolute value of AOPT is a coordinate system ID number (CID on *DEFINE_COORDINATE_NODES, *DEFINE_COORDINATE_SYSTEM or *DEFINE_COORDINATE_VECTOR).
- A1, A2, A3 Components of vector a for AOPT = 2

Card 3	1	2	3	4	5	6	7	8
Variable	V1	V2	V3	D1	D2	D3	MANGL	THICK
Type	F	F	F	F	F	F	F	I

VARIABLE

DESCRIPTION

- V1, V2, V3 Components of vector v for AOPT = 3

VARIABLE	DESCRIPTION
D1, D2, D3	Components of vector \mathbf{d} for AOPT = 2
MANGL	Material angle in degrees for AOPT = 0 and 3. It may be overwritten on the element card; see *ELEMENT_SHELL_BETA.
THICK	Balance thickness changes of the material due to the matrix response when calculating the fiber stresses. Stresses can be scaled to account for the fact that fiber cross-sectional usually does not change. EQ.0: No scaling EQ.1: Scaling

Fiber Viscosity Card. Additional card for VISC > 0 only. See [Remark 3](#).

Card 4	1	2	3	4	5	6	7	8
Variable	VG1	VB1	VG2	VB2	VG3	VB3	VG4	VB4
Type	F	F	F	F	F	F	F	F

VARIABLE	DESCRIPTION
VG k	Relaxation modulus G_k for the k^{th} term of the Prony series for viscoelastic fibers
VB k	Decay constant β_k for the k^{th} term of the Prony series for viscoelastic fibers

Card 5	1	2	3	4	5	6	7	8
Variable	IDF1	ALPH1	EF1	LCEF1	G23_1	G31_1	DAF1	DAM1
Type	I	F	F	I	F	F	I	I

VARIABLE	DESCRIPTION
IDF1	ID for 1 st fiber family for post-processing
ALPH1	Orientation angle α_1 for 1 st fiber with respect to overall material direction

VARIABLE	DESCRIPTION
EF1	Young's modulus for 1 st fiber family
LCEF1	Load curve for stress as a function of fiber strain of 1 st fiber. With this option active, EF1 is ignored.
G23_1	Transverse shear modulus orthogonal to direction of 1 st fiber
G31_1	Transverse shear modulus in direction of 1 st fiber
DAF1	<p>Load curve or table ID for damage parameter d_1^f for 1st fiber (see Remark 2). If a curve, DAF1 specifies damage as a function of fiber strain (for compression and elongation). If DAF1 refers to a table, then two different damage functions for tensile and compressive stresses are input. The values in the table are arbitrary and exist only to index the two curves. The first indexed curve is assumed to specify tensile damage as a function of fiber strains while second curve specifies compressive damage as a function of fiber strains. input different damage functions for tensile and compressive stresses. Any other curves input with the table definition are ignored.</p> <p>The damage parameter d_1^f ranges from 0.0 for an undamaged fiber to 1.0 for a failed fiber family. If all families have failed, material failure at the integration point is initiated.</p>
DAM1	<p>Load curve or table ID for damage parameter d_1^m for matrix material based on the current deformation status of the 1st fiber (see Remark 2). If a curve, it specifies damage as a function of fiber strain (for compression and elongation). If a table, then the values are fiber strain rates which index damage as a function of fiber strain curves.</p> <p>The damage parameter d_1^m ranges from 0.0 to 1.5. A value of 0.0 indicates an undamaged matrix, whereas 1.0 refers to a completely damaged matrix. To initiate failure of the composite at the integration point, a matrix damage d_1^m of 1.5 must be reached. Naturally, the mechanical behavior of the matrix does not change for damage values between 1.0 and 1.5.</p>

Card 6	1	2	3	4	5	6	7	8
Variable	G12	LCG12	ALOC12	GLOC12	METH12	DAM12		
Type	F	I	F	F	I	I		

VARIABLE**DESCRIPTION**

G12	Linear shear modulus for shearing between fiber families 1 and 2
LCG12	Curve ID for shear stress as a function of shearing type as specified with METH12 between the 1 st and 2 nd fibers. See Remark 1 .
ALOC12	Locking angle (in radians) for shear between fiber families 1 and 2
GLOC12	Linear shear modulus for shear angles larger than ALOC12
METH12	Option for shear response between fiber 1 and 2 (see Remark 1): EQ.0: Elastic shear response. Curve LCG12 specifies shear stress as a function of the scalar product of the fiber directions. EQ.1: Elasto-plastic shear response. Curve LCG12 specifies yield shear stress as a function of the normalized scalar product of the fiber directions. EQ.2: Elastic shear response. Curve LCG12 specifies shear stress as a function of shear angle (radians) between the fibers. EQ.3: Elasto-plastic shear response. Curve LCG12 defines yield shear stress as a function of normalized shear angle between the fibers. EQ.4: Elastic shear response. Curve LCG12 specifies shear stress as a function of shear angle (radians) between the fibers. This option is a special implementation for non-crimped fabrics, where one of the fiber families corresponds to a stitching. EQ.5: Elasto-plastic shear response. Curve LCG12 specifies yield shear stress as a function of normalized shear angle between the fibers. This option is a special implementation for non-crimped fabrics, where one of the fiber families corresponds to a stitching.

VARIABLE**DESCRIPTION**

EQ.10: Elastic shear response. Curve LCG12 specifies shear stress as a function of shear angle (radians) between the fibers. This option is tailored for woven fabrics and guarantees a pure shear stress response.

EQ.11: Elasto-plastic shear response. Curve LCG12 specifies yield shear stress as a function of normalized shear angle. This option is tailored for woven fabrics and guarantees a pure shear stress response

DAM12

Load curve ID defining the damage parameter d_{12}^m for the matrix as function of shear angle (radians) between the 1st and 2nd fiber (see [Remark 2](#)). The damage parameter d_{12}^m ranges from 0.0 to 1.5. A value of 0.0 indicates an undamaged matrix, whereas 1.0 refers to a completely damaged matrix. To initiate failure of the composite at the integration point, a matrix damage d_{12}^m of 1.5 must be reached. Naturally, the mechanical behavior of the matrix does not change for damage values between 1.0 and 1.5.

Card 7	1	2	3	4	5	6	7	8
Variable	IDF2	ALPH2	EF2	LCEF2	G23_2	G31_2	DAF2	DAM2
Type	I	F	F	I	F	F	I	I

VARIABLE**DESCRIPTION**

IDF2

ID for 2nd fiber family for post-processing

ALPH2

Orientation angle α_2 for 2nd fiber with respect to overall material direction

EF2

Young's modulus for 2nd fiber family

LCEF2

Load curve for stress as a function of fiber strain of 2nd fiber. With this option active, EF2 is ignored.

G23_2

Transverse shear modulus orthogonal to direction of 2nd fiber

G31_2

Transverse shear modulus in direction of 2nd fiber

VARIABLE	DESCRIPTION
----------	-------------

DAF2 Load curve or table ID for damage parameter d_2^f for 2nd fiber (see [Remark 2](#)). If a curve, DAF2 specifies damage as a function of fiber strain (for compression and elongation). If DAF2 refers to a table, then two different damage functions for tensile and compressive stresses are input. The values in the table are arbitrary and exist only to index the two curves. The first indexed curve is assumed to specify tensile damage as a function of fiber strains while second curve specifies compressive damage as a function of fiber strains. input different damage functions for tensile and compressive stresses. Any other curves input with the table definition are ignored.

The damage parameter d_2^f ranges from 0.0 for an undamaged fiber to 1.0 for a failed fiber family. If all families have failed, material failure at the integration point is initiated.

DAM2 Load curve or table ID for damage parameter d_2^m for matrix material based on the current deformation status of the 2nd fiber (see [Remark 2](#)). If a curve, it specifies damage as a function of fiber strain (for compression and elongation). If a table, then the values are fiber strain rates which index damage as a function of fiber strain curves.

The damage parameter d_2^m ranges from 0.0 to 1.5. A value of 0.0 indicates an undamaged matrix, whereas 1.0 refers to a completely damaged matrix. To initiate failure of the composite at the integration point, a matrix damage d_2^m of 1.5 must be reached. Naturally, the mechanical behavior of the matrix does not change for damage values between 1.0 and 1.5.

Card 8	1	2	3	4	5	6	7	8
Variable	G23	LCG23	ALOC23	GLOC23	METH23	DAM23		
Type	F	I	F	F	I	F		

VARIABLE	DESCRIPTION
----------	-------------

G23 Linear shear modulus for shearing between fiber families 2 and 3

LCG23 Curve ID for shear stress as a function of shearing type as specifies with METH23 between the 2nd and 3rd fibers. See [Remark 1](#).

VARIABLE	DESCRIPTION
ALOC23	Locking angle (in radians) for shear between fiber families 2 and 3
GLOC23	Linear shear modulus for shear angles larger than ALOC23
METH23	Option for shear response between fibers 2 and 3 (see METH12 for input options and Remark 1).
DAM23	Load curve ID defining the damage parameter d_{23}^m for the matrix as function of shear angle (in radians) between the 1 st and 2 nd fiber (see Remark 2). The damage parameter d_{23}^m ranges from 0.0 to 1.5. A value of 0.0 indicates an undamaged matrix, whereas 1.0 refers to a completely damaged matrix. To initiate failure of the composite at the integration point, a matrix damage d_{23}^m of 1.5 must be reached. Naturally, the mechanical behavior of the matrix does not change for damage values between 1.0 and 1.5.

Card 9	1	2	3	4	5	6	7	8
Variable	IDF3	ALPH3	EF3	LCEF3	G23_3	G31_3	DAF3	DAM3
Type	I	F	F	I	F	F	I	I

VARIABLE	DESCRIPTION
IDF3	ID for 3 rd fiber family for post-processing
ALPH3	Orientation angle α_3 for 3 rd fiber with respect to overall material direction
EF3	Young's modulus for 3 rd fiber family
LCEF3	Load curve for stress versus fiber strain of 3 rd fiber. With this option active, EF3 is ignored.
G23_3	Transverse shear modulus orthogonal to direction of 3 rd fiber
G31_3	Transverse shear modulus in direction of 3 rd fiber

VARIABLE	DESCRIPTION
----------	-------------

DAF3 Load curve or table ID for damage parameter d_3^f for 3rd fiber (see [Remark 2](#)). If a curve, DAF3 specifies damage as a function of fiber strain (for compression and elongation). If DAF3 refers to a table, then two different damage functions for tensile and compressive stresses are input. The values in the table are arbitrary and exist only to index the two curves. The first indexed curve is assumed to specify tensile damage as a function of fiber strains while second curve specifies compressive damage as a function of fiber strains. input different damage functions for tensile and compressive stresses. Any other curves input with the table definition are ignored.

The damage parameter d_3^f ranges from 0.0 for an undamaged fiber to 1.0 for a failed fiber family. If all families have failed, material failure at the integration point is initiated.

DAM3 Load curve or table ID for damage parameter d_3^m for matrix material based on the current deformation status of the 3rd fiber (see [Remark 2](#)). If a curve, it specifies damage as a function of fiber strain (for compression and elongation). If a table, then the values are fiber strain rates which index damage as a function of fiber strain curves.

The damage parameter d_3^m ranges from 0.0 to 1.5. A value of 0.0 indicates an undamaged matrix, whereas 1.0 refers to a completely damaged matrix. To initiate failure of the composite at the integration point, a matrix damage d_3^m of 1.5 must be reached. Naturally, the mechanical behavior of the matrix does not change for damage values between 1.0 and 1.5.

The following card is optional.

Card 10	1	2	3	4	5	6	7	8
Variable	POSTV	VISCS	IHIS					
Type	F	F	F					

VARIABLE	DESCRIPTION
----------	-------------

POSTV Parameter for outputting additional history variables that might be useful for post-processing. See [Remark 4](#).

VARIABLE	DESCRIPTION
VISCS	Portion of viscous relaxation moduli VGk that is accounted for in time step size calculation
IHIS	Flag for material properties initialization: EQ.0: Material properties defined in Cards 1 - 9 are used GE.1: Use *INITIAL_STRESS_SHELL to initialize some material properties on an element-by-element basis (see Remark 5 below).

Remarks:

1. **Stress Calculation.** This material features an additive split of the matrix and reinforcement contributions to the stress. Therefore, the combined stress response, σ , equals the sum $\sigma^m + \sigma^f$.

The matrix uses an elastic-plastic material formulation with a von-Mises yield criterion. This material supports a mixed hardening approach.

We formulated the contribution of the fiber reinforcement as a hyperelastic material. Based on the orientation angle, α_i , of the i^{th} fiber family, LS-DYNA computes an initial fiber direction in the element coordinate system \mathbf{m}_i^0 . By using the deformation gradient, \mathbf{F} , the current fiber configuration is given as $\mathbf{m}_i = \mathbf{F} \mathbf{m}_i^0$, containing all necessary information on fiber strain and reorientation. Here, this vector is always orthogonal to the shell normal and can, thus, be represented by the two in-plane vector components.

Following standard textbook mechanics for anisotropic and hyperelastic materials, the elastic stresses within the fibers due to tension or compression are given as

$$\sigma_T^f = \sum_{i=1}^n \sigma_{T,i}^f(\lambda_i) = \sum_{i=1}^n \frac{1}{J} f_i(\lambda_i) (\mathbf{m}_i \otimes \mathbf{m}_i) ,$$

where the function f_i of the fiber strain λ_i corresponds to the load curve LCEFi. n is the number of fiber families.

The shear behavior of the reinforcement can be controlled by METHij. For values less than 10, the behavior is again standard textbook mechanics:

$$\sigma_S^f = \sum_{i=1}^{n-1} \sigma_{S,i,i+1}^f = \sum_{i=1}^{n-1} \frac{1}{J} g_{i,i+1}(\kappa_{i,i+1}) (\mathbf{m}_i \otimes \mathbf{m}_{i+1}) .$$

Here $\kappa_{i,i+1}$ represents the employed shear measure (scalar product or shear angle in radians). In general, the dyadic product $\mathbf{m}_i \otimes \mathbf{m}_{i+1}$ does not define a shear stress tensor. This formulation might result in unphysical shear behavior in the case of woven fabrics. Therefore, we devised METH $ij = 10$ and 11 to always give a pure shear stress tensor, σ_S^f .

For even values of METH ij , an elastic shear response is assumed. If defined, the load curve LCG ij corresponds to function $g_{i,j}$. In this case the values of G_{ij} , ALOC ij and GLOC ij are ignored.

For odd values of METH ij on the other hand, an elasto-plastic shear behavior is assumed and the load curve LCG ij defines the yield stress value as function of a normalized shear parameter. This implies that the load curve needs to be defined for abscissa values between 0.0 and 1.0. A first elastic regime, which is controlled by the linear shear stiffness G_{ij} , is assumed until the yield stress given in the load curve for normalized shear value 0.0 is reached. A second linear elastic regime is defined for shear angles (ξ_{ij}) / fiber angles (η_{ij}) larger than the locking angle ALOC ij . The corresponding stiffness in that regime is GLOC ij . At the transition point to the second elastic regime, the shear stress corresponds to the load curve value for a normalized shear of 1.0.

2. **Damage and Failure.** This material features a phenomenological description of damage and failure. User-defined load curves specify several damage variables as functions of the fiber strain values λ_i or shear $\kappa_{i,i+1}$. Here, damage parameters are always accumulated and cannot decrease during the simulation.

If input parameter DAF i refers to a load curve, it specifies the damage parameter d_i^f as function of the fiber strain λ_i . If DAF i refers to a table, the material distinguishes between tensile and compressive damage. In that case, two parameters $d_i^{f,t}$ and $d_i^{f,c}$ are introduced as functions of the fiber strain λ_i (given by two load curves referred to by the table definition) and are both evaluated in every time step. The effective damage parameter d_i^f is then defined as

$$d_i^f(\lambda_i) = \begin{cases} d_i^{f,c}(\lambda_i), & \lambda_i < 0 \\ d_i^{f,t}(\lambda_i), & \lambda_i \geq 0 \end{cases}$$

The damage parameter d_i^f degrades the fiber stress contribution $\sigma_{T,i}^f$:

$$\tilde{\sigma}_T^f = \sum_{i=1}^n \left(\mathbf{1} - d_i^f(\lambda_i) \right) \sigma_{T,i}^f(\lambda_i) .$$

Failure of the composite material at the integration point is initiated as soon as all fibers have failed: $\min_i d_i^f = 1.0$.

We assume matrix damage to result from the fiber straining and reorientating. Consequently, the input includes load curves DAM_i and DAM_{ij} to specify damage parameters $d_i^m(\lambda_i)$ and $d_{i,i+1}^m(\kappa_{i,i+1})$, respectively. The overall matrix damage parameter d^m is given by

$$d^m = \max \left(\max_{i \leq n} d_i^m(\lambda_i), \max_{i < n} d_{i,i+1}^m(\kappa_{i,i+1}) \right) .$$

Matrix failure ($d^m = 1.0$) does not necessarily initiate failure of the composite material. In this implementation, matrix damage parameters d_i^m and $d_{i,i+1}^m$ that exceed a value of 1.0 are admissible. Failure of the composite is initiated as soon as the damage parameter reaches 1.5. To account for this delayed failure, the degradation of the matrix stresses is given by:

$$\hat{\sigma}^m = (1 - \min(1.0, d^m)) \sigma^m .$$

3. **Fiber Viscosity.** Input parameter VISC activates fiber viscosity. This feature adds numerical damping to the post-damage behavior of the material. Damping might be necessary since brittle fiber failure tends to induce shockwaves through the material, resulting in oscillations or even unphysical damage propagation.

If activated, an additional viscous stress term is added to the fiber contribution:

$$\sigma_{T,v}^f = \sum_{i=1}^n \frac{1}{J} \left(\int_0^t f_v(t - \tau) \frac{\partial \lambda_i(\tau)}{\partial \tau} d\tau \right) (\mathbf{m}_i \otimes \mathbf{m}_i) .$$

The relaxation function, f_v , is represented by up to four terms of the Prony series expansions and thus reads

$$f_v(t) = \sum_k G_k e^{-\beta_k t}$$

with relaxation moduli G_k and decay constants β_k .

4. **History Data.** This material formulation outputs to d3plot additional data for post-processing to the set of history variables if requested. The parameter POSTV specifies the data to be written. Its value is calculated as

$$\text{POSTV} = a_1 + 2 a_2 + 4 a_3 + 8 a_4 + 16 a_5 + 32 a_6 + 64 a_7 .$$

Each flag a_i is a binary number (can be either 1 or 0) and corresponds to one particular type of post-processing variable according to the following table.

Flag	Description	Variables	# History Var
a_1	Fiber angle	η_{12}, η_{23}	2
a_2	Fiber ID	IDF1, IDF2, IDF3	3
a_3	Fiber strain	$\lambda_1, \lambda_2, \lambda_3$	3
a_4	Fiber direction (in global coordinates)	$\mathbf{m}_1^g, \mathbf{m}_2^g, \mathbf{m}_3^g$	9
a_5	Individual fiber stresses	$f_1(\lambda_1), f_2(\lambda_2), f_3(\lambda_3)$	3
a_6	Fiber stress tensor	$\sigma_{11}^f, \sigma_{22}^f, \sigma_{33}^f, \sigma_{12}^f, \sigma_{23}^f, \sigma_{31}^f$	6
a_7	Fiber direction (in material coordinates)	$\mathbf{m}_1^m, \mathbf{m}_2^m, \mathbf{m}_3^m$	6

The above table also shows the order of output as well as the number of extra history variables associated with the particular flag. In total NXH extra variables are required depending on the choice of parameter POSTV. For example, the maximum number of additional variables is NXH = 32 for POSTV = 127.

As mentioned in [Remark 1](#) fiber orientation is represented in the material subroutine as vector \mathbf{m}_i defined in the element coordinate system. Prior to writing to the list of histories the vector is transformed into the global coordinate system with three vector components for $a_4 = 1$ and/or into the overall material coordinate system with two vector components for $a_7 = 1$.

A more complete list of potentially helpful history variables is given in the following table. The variable NEIPS in *DATABASE_EXTENT_BINARY must be set to output these history variables.

History Variable #	Description
3	Number of fibers
4	NXH
$5 \rightarrow NXH + 4$	Variables as described in preceding table
$NXH + 5$	POSTV
$NXH + 6, NXH + 7$	Shear angles ζ_{12} and ζ_{23}

History Variable #	Description
NXH + 8	Matrix damage parameter d^m
NXH + 9 → NXH + 11	Fiber tensile damage parameter $d_i^{f,t}$
NXH + 12 → NXH + 14	Fiber compressive damage param. $d_i^{f,c}$
NXH + 15 → NXH + 20	Matrix stress tensor in element coordinate system
NXH+21 → NXH + 26	Deformation gradient

5. **Description of IHIS.** Some material data can be initialized on an element-by-element basis through history variables defined with *INITIAL_STRESS_SHELL starting at position HISV5.

How the data is interpreted depends on the parameter IHIS. Following the same concept as for parameter POSTV, the value of IHIS is computed by the following expression:

$$IHIS = a_1 + 2 a_2$$

Each flag a_i is a binary number (can be either 1 or 0) and corresponds to one particular type of material variable. So far, the only material variables implemented are fiber orientation in two different coordinate systems, global and material. Thus, at most one of the flags a_1 and a_2 should be set to 1.

Flag	Description	Variables	# History Var
a_1	Fiber direction (in global coordinates)	$\mathbf{m}_1^g, \mathbf{m}_2^g, \mathbf{m}_3^g$	9
a_2	Fiber direction (in material coordinates)	$\mathbf{m}_1^m, \mathbf{m}_2^m, \mathbf{m}_3^m$	6

***MAT_REINFORCED_THERMOPLASTIC_UDFIBER**

This is Material Type 249. It describes a material with unidirectional fiber reinforcements and considers up to three distinct fiber directions. Each fiber family is described by a spatially transversely isotropic neo-Hookean constitutive law. The implementation is based on an adapted version of the material described by Bonet and Burton (1998). The material is only available for thin shell elements and in explicit simulations.

Card Summary:

Card 1. This card is required.

MID	RO	EM	PRM	G	EZDEF		
-----	----	----	-----	---	-------	--	--

Card 2. This card is required.

NFIB	AOPT	XP	YP	ZP	A1	A2	A3
------	------	----	----	----	----	----	----

Card 3. This card is required.

V1	V2	V3	D1	D2	D3	MANGL	
----	----	----	----	----	----	-------	--

Card 4. This card is required.

IDF1	ALPH1	EF1	KAP1				
------	-------	-----	------	--	--	--	--

Card 5. This card is required.

IDF2	ALPH2	EF2	KAP2				
------	-------	-----	------	--	--	--	--

Card 6. This card is required.

IDF3	ALPH3	EF3	KAP3				
------	-------	-----	------	--	--	--	--

Data Card Definitions:

Card 1	1	2	3	4	5	6	7	8
Variable	MID	RO	EM	PRM	G	EZDEF		
Type	A	F	F	F	F	F		

VARIABLE	DESCRIPTION
MID	Material identification. A unique number or label be specified (see *PART).
RO	Density
EM	Isotropic Young's modulus, E_{iso}
PR	Poisson's ratio, ν
G	Linear shear modulus, G_{fib}
EZDEF	Algorithmic parameter. If set to 1, last row of deformation gradient is not updated during the calculation.

Card 2	1	2	3	4	5	6	7	8
Variable	NFIB	AOPT	XP	YP	ZP	A1	A2	A3
Type	I	F	F	F	F	F	F	F

VARIABLE	DESCRIPTION
NFIB	Number of fiber families to be considered (maximum of 3)
AOPT	Material axes option (see MAT_OPTIONTROPIC_ELASTIC for a more complete description): <ul style="list-style-type: none"> EQ.0.0: Locally orthotropic with material axes determined by element nodes, as with *DEFINE_COORDINATE_NODES, and then rotated about the shell element normal by the angle MANGL. EQ.2.0: Globally orthotropic with material axes determined by vectors defined below, as with *DEFINE_COORDINATE_VECTOR.

VARIABLE**DESCRIPTION**

EQ.3.0: Locally orthotropic material axes determined by a vector \mathbf{v} and the normal vector to the plane of the element. \mathbf{a} is determined by taking the cross product of \mathbf{v} with the normal vector, \mathbf{b} is determined by taking the cross product of the normal vector with \mathbf{a} , and \mathbf{c} is the normal vector. Then, \mathbf{a} and \mathbf{b} are rotated about \mathbf{c} by an angle MANGL. MANGL may be set in the keyword input for the element or in the input for this keyword.

LT.0.0: The absolute value of AOPT is a coordinate system ID number (CID on *DEFINE_COORDINATE_NODES, *DEFINE_COORDINATE_SYSTEM or *DEFINE_COORDINATE_VECTOR).

XP, YP, ZP

Coordinates of point p for AOPT = 1

A1, A2, A3

Components of vector \mathbf{a} for AOPT = 2

Card 3	1	2	3	4	5	6	7	8
Variable	V1	V2	V3	D1	D2	D3	MANGL	
Type	F	F	F	F	F	F	F	

VARIABLE**DESCRIPTION**

V1, V2, V3

Components of vector \mathbf{v} for AOPT = 3

D1, D2, D3

Components of vector \mathbf{d} for AOPT = 2

MANGL

Material angle in degrees for AOPT = 0 and. It may be overwritten on the element card; see *ELEMENT_SHELL_BETA.

Card 4	1	2	3	4	5	6	7	8
Variable	IDF1	ALPH1	EF1	KAP1				
Type	I	F	F	F				

Card 5	1	2	3	4	5	6	7	8
Variable	IDF2	ALPH2	EF2	KAP2				
Type	I	F	F	F				

Card 6	1	2	3	4	5	6	7	8
Variable	IDF3	ALPH3	EF3	KAP3				
Type	I	F	F	F				

VARIABLE**DESCRIPTION**

IDF i	ID for i^{th} fiber family for post-processing
ALPH i	Orientation angle α_i for i^{th} fiber with respect to overall material direction
EF i	Young's modulus E_i for i^{th} fiber family
KAP i	Fiber volume ratio κ_i of i^{th} fiber family

Stress Calculation:

In this model up to three distinct fiber families are considered. We assume that there is no interaction between the families. Thus, the resulting stress tensor is the sum of the single fiber responses. Each fiber response is the sum of an isotropic and a spatially transversely isotropic neo-Hookean stress contribution, σ_i^{iso} and σ_i^{tr} , respectively. The implementation is based on the work of Bonet and Burton (1998), adapted by BMW for simulation of unidirectional fabrics (see references below).

The isotropic stress tensor, σ_i^{iso} , depends on an isotropic shear modulus, μ , and an isotropic bulk modulus, λ_i where:

$$\mu = \frac{E_{\text{iso}}}{2(1 + \nu)} \text{ and } \lambda_i = \frac{E_{\text{iso}}(\nu + n_i \nu^2)}{2(1 + \nu)}.$$

Here, the variable n_i denotes the ratio between stiffness orthogonally to the fibers and in fiber direction, that is, $n_i = E_{\text{iso}}/E_i$. E_{iso} , ν , and E_i are input parameters. Using the left Cauchy-Green tensor, \mathbf{b} , the isotropic neo-Hookean model reads:

$$\sigma_i^{\text{iso}} = \frac{\mu}{J} (\mathbf{b} - \mathbf{I}) + \lambda_i (J - 1) \mathbf{I}.$$

Based on the orientation angle α_i of the i^{th} fiber family, an initial fiber direction \mathbf{m}_i^0 is computed. The deformation gradient, \mathbf{F} , transforms the initial fiber configuration to the current fiber configuration as $\mathbf{m}_i = \mathbf{F}\mathbf{m}_i^0$. This vector contains all necessary information on fiber elongation and reorientation.

The spatially transversely isotropic neo-Hookean formulation is given by:

$$J\sigma_i^{\text{tr}} = 2\beta_i(I_4 - 1)\mathbf{I} + 2(\alpha + 2\beta_i \ln J + 2\gamma_i(I_4 - 1))\mathbf{m}_i \otimes \mathbf{m}_i - \alpha(\mathbf{b}\mathbf{m}_i \otimes \mathbf{m}_i + \mathbf{m}_i \otimes \mathbf{b}\mathbf{m}_i)$$

with material parameters

$$\alpha = \mu - G_{\text{fib}}, \quad \beta_i = \frac{E_{\text{iso}}\nu^2(1 - n_i)}{4m_i(1 + \nu)}, \quad m_i = 1 - \nu - 2n_i\nu^2,$$

$$\gamma_i = \frac{E_i\kappa_i(1 - \nu)}{8m} - \frac{\lambda_i + 2\mu}{8} + \frac{\alpha}{2} - \beta_i.$$

The parameter EZDEF activates a modification of the model. Instead of the standard deformation gradient, \mathbf{F} , a modified tensor $\tilde{\mathbf{F}}$ is employed to calculate current fiber directions \mathbf{m}_i and left Cauchy-Green tensor \mathbf{b} . For tensor $\tilde{\mathbf{F}}$ only the first two rows of the deformation gradient are updated based on the deformation of the element. This simplification can in some cases increase the stability of the model, especially if the structure undergoes large deformations.

References:

- [1] Bonet, J., and A. J. Burton. "A simple orthotropic, transversely isotropic hyperelastic constitutive equation for large strain computations." *Computer methods in applied mechanics and engineering* 162.1 (1998): 151-164.
- [2] Senner, T., et al. "A modular modeling approach for describing the in-plane forming behavior of unidirectional non-crimp-fabrics." *Production Engineering* 8.5 (2014): 635-643.
- [3] Senner, T., et al. "Bending of unidirectional non-crimp-fabrics: experimental characterization, constitutive modeling and application in finite element simulation." *Production Engineering* 9.1 (2015): 1-10.

History Data:

History Variable #	Description
3	ID of 1 st fiber
4	ID of 2 nd fiber
5	ID of 3 rd fiber
6 → 8	Current direction of 1 st fiber
9 → 11	Current direction of 2 nd fiber
12 → 14	Current direction of 3 rd fiber
15	Number of fibers
16	Projected orthogonal fiber strain (1 st fiber)
17	Projected parallel fiber strain (1 st fiber)
18	Shear angle (1 st fiber) in rad
19	Euler-Almansi strain (1 st fiber)
20	Porosity (1 st fiber)
21	Fiber volume ratio (1 st fiber)
22	Projected orthogonal fiber strain (2 nd fiber)
23	Projected parallel fiber strain (2 nd fiber)
24	Shear angle (2 nd fiber) in rad
25	Euler-Almansi strain (2 nd fiber)
26	Porosity (2 nd fiber)
27	Fiber volume ratio (2 nd fiber)
28	Projected orthogonal fiber strain (3 rd fiber)
29	Projected parallel fiber strain (3 rd fiber)
30	Shear angle (3 rd fiber) in rad

History Variable #	Description
31	Euler-Almansi strain (3 rd fiber)
32	Porosity (3 rd fiber)
33	Fiber volume ratio (3 rd fiber)

***MAT_TAILORED_PROPERTIES**

This is Material Type 251. It is similar to MAT_PIECEWISE_LINEAR_PLASTICITY or *MAT_024 (see full description there). Unlike *MAT_024, it has a 3D table option that uses a history variable (such as hardness and temperature) from a previous calculation to evaluate the plastic behavior as a function of 1) history variable, 2) strain rate, and 3) plastic strain. Starting with release R12, it is also possible to use a 4D table option with two history variables, that is, the plastic behavior would be a function of 1) history variable HISVN + 1, 2) history variable HISVN, 3) strain rate, and 4) plastic strain. This material is available for shell and solid elements.

Card 1	1	2	3	4	5	6	7	8
Variable	MID	RO	E	PR			FAIL	TDEL
Type	A	F	F	F			F	F
Default	none	none	none	none			10 ²⁰	0

Card 2	1	2	3	4	5	6	7	8
Variable			LCSS		VP	HISVN	PHASE	
Type			F		F	I	F	
Default			0		0	0	0	

Card 3	1	2	3	4	5	6	7	8
Variable	EPS1	EPS2	EPS3	EPS4	EPS5	EPS6	EPS7	EPS8
Type	F	F	F	F	F	F	F	F
Default	0	0	0	0	0	0	0	0

Card 4	1	2	3	4	5	6	7	8
Variable	ES1	ES2	ES3	ES4	ES5	ES6	ES7	ES8
Type	F	F	F	F	F	F	F	F
Default	0	0	0	0	0	0	0	0

VARIABLE**DESCRIPTION**

MID	Material identification. A unique number or label must be specified (see *PART).
RO	Mass density
E	Young's modulus
PR	Poisson's ratio
FAIL	<p>Failure flag:</p> <p>LT.0.0: User defined failure subroutine, matusr_24 in dyn21.F, is called to determine failure</p> <p>EQ.0.0: Failure is not considered. This option is recommended if failure is not of interest since many calculations will be saved.</p> <p>GT.0.0: Effective plastic strain to failure. When the plastic strain reaches this value, the element is deleted from the calculation.</p>
TDEL	Minimum time step size for automatic element deletion
LCSS	<p>Load curve ID or Table ID</p> <p>Load Curve. When LCSS is a load curve ID, it is taken as defining stress as a function of effective plastic strain. If defined, EPS1 - EPS8 and ES1 - ES8 are ignored.</p>

VARIABLE

DESCRIPTION

VARIABLE	DESCRIPTION
	<p>Tabular Data. The table ID defines for each strain rate value a load curve ID giving the stress as a function effective plastic strain for that rate; see Figure M24-1. When the strain rate falls below the minimum value, the stress as a function of effective plastic strain curve for the lowest value of strain rate is used. Likewise, when the strain rate exceeds the maximum value the stress as a function of effective plastic strain curve for the highest value of strain rate is used. EPS1 - EPS8 and ES1 - ES8 are ignored if a table ID is defined. Linear interpolation between the discrete strain rates is used by default.</p> <p>Logarithmically Defined Tables. Logarithmic interpolation between discrete strain rates is assumed if the <i>first</i> value in the table is negative, in which case LS-DYNA assumes that all the table values represent the natural logarithm of a strain rate. Since the tables are internally discretized to equally space the table values, it makes good sense from an accuracy standpoint that the table values represent the natural log of strain rate when the lowest strain rate and highest strain rate differ by several orders of magnitude. There is some additional computational cost associated with invoking logarithmic interpolation.</p> <p>Multi-Dimensional Tables. Stress values can also be dependent upon history variables. The 3D table gives stress versus plastic strain as a function of strain rates as a function of one history variable (see HISVN). The 4D table gives stress versus plastic strain as a function of strain rates as a function of two history variable values (see HISVN).</p>
VP	<p>Formulation for rate effects:</p> <p>EQ.0.0: Scale yield stress (default)</p> <p>EQ.1.0: Viscoplastic formulation</p>
HISVN	<p>Location of the history variable in the history array of *INITIAL_STRESS_SHELL/SOLID that is used to evaluate the 3D table LCSS. If a 4D table is used, then HISVN is the location of the history variable for the *TABLE_3D value, and HISVN + 1 is the location of the history variable for the *TABLE_4D values.</p>
PHASE	<p>Constant value to evaluate the 3D table LCSS. PHASE is only used if HISVN = 0.</p>

VARIABLE	DESCRIPTION
EPS1 - EPS8	Effective plastic strain values (optional). At least 2 points should be defined. The first point must be zero corresponding to the initial yield stress.
ES1 - ES8	Corresponding yield stress values to EPS1 - EPS8

Remarks:

If the 3D or 4D table is used for LCSS, interpolation is used to find the corresponding stress value for the current plastic strain, strain rate, and history variable(s). In addition, extrapolation is used for the history variable evaluation, which means that some upper and lower "limit curves" have to be used, if extrapolation is not desired.

If material history is written to the dynain file using *INTERFACE_SPRINGBACK_LS-DYNA, the history variables of *MAT_251 (for example, hardness and temperature) are written to positions HISV6 and HISV7 of *INITIAL_STRESS_SHELL/SOLID.

It is recommended to set HISVN = 6 and to put the history variables on position HISV6 (and HISV7 if TABLE_4D is used) if *MAT_251 is used in combination with *MAT_ADD_...

***MAT_TOUGHENED_ADHESIVE_POLYMER**

This is Material Type 252, the Toughened Adhesive Polymer model (TAPO). It is based on non-associated $I_1 - J_2$ plasticity constitutive equations and was specifically developed to represent the mechanical behaviour of crash optimized high-strength adhesives under combined shear and tensile loading. This model includes material softening due to damage, rate-dependency, and a constitutive description for the mechanical behaviour of bonded connections under compression.

A detailed description of this material can be found in Matzenmiller and Burbulla [2013]. This material model can be used with solid elements or with cohesive elements in combination with *MAT_ADD_COHESIVE.

Card 1	1	2	3	4	5	6	7	8
Variable	MID	RO	E	PR	FLG	JCFL	DOPT	
Type	A	F	F	F	I	I	I	

Card 2	1	2	3	4	5	6	7	8
Variable	LCSS	TAU0	Q	B	H	C	GAM0	GAMM
Type	I	F	F	F	F	F	F	F

Card 3	1	2	3	4	5	6	7	8
Variable	A10	A20	A1H	A2H	A2S	POW		SRFILT
Type	F	F	F	F	F	F		F

Card 4	1	2	3	4	5	6	7	8
Variable			D1	D2	D3	D4	D1C	D2C
Type			F	F	F	F	F	F

VARIABLE	DESCRIPTION
MID	Material identification. A unique number or label must be specified (see *PART).
RO	Mass density, ρ
E	Young's modulus, E
PR	Poisson's ratio, ν
FLG	Flag to choose between yield functions f and \hat{f} (see Remarks): EQ.0: Cap in tension and nonlinear Drucker & Prager in compression EQ.2: Cap in tension and von Mises in compression
JCFL	Johnson & Cook constitutive failure criterion flag (see Remarks): EQ.0: use triaxiality factor only in tension, EQ.1: use triaxiality factor in tension and compression.
DOPT	Damage criterion flag \hat{D} or \check{D} (see Remarks): EQ.0: damage model uses damage plastic strain r , EQ.1: damage model uses plastic arc length γ_v .
LCSS	Curve ID or Table ID Load Curve. The curve specifies yield stress τ_Y as a function of plastic strain r . Table Data. If a 2D table is defined, for each strain rate value the table specifies a curve ID giving the yield stress as a function of plastic strain for that strain rate (see *DEFINE_TABLE). If a 3D table is defined, for each temperature value, a table ID is specified which, in turn, maps strain rates to curves giving the yield stress as a function of plastic strain (see DEFINE_TABLE_3D). The yield stress as a function of plastic strain curve for the lowest value of strain rate or temperature is used when the strain rate or temperature falls below the minimum value. Likewise, maximum values cannot be exceeded. Hardening variables are ignored with this option (TAU0, Q, B, H, C, GAM0, and GAMM).
TAU0	Initial shear yield stress, τ_0
Q	Isotropic nonlinear hardening modulus, q

VARIABLE	DESCRIPTION
B	Isotropic exponential decay parameter, b
H	Isotropic linear hardening modulus, H
C	Strain rate coefficient C .
GAM0	Quasi-static threshold strain rate, γ_0
GAMM	Maximum threshold strain rate, γ_m
A10	Yield function parameter: initial value a_{10} of $a_1 = \hat{a}_1(r)$
A20	Yield function parameter: initial value a_{20} of $a_2 = \hat{a}_2(r)$
A1H	Yield function parameter a_1^H for formative hardening (ignored if FLG = 2)
A2H	Yield function parameter a_2^H for formative hardening (ignored if FLG = 2)
A2S	Plastic potential parameter a_2^* for hydrostatic stress term
POW	Exponent n of the phenomenological damage model
SRFILT	Strain rate filtering parameter in exponential moving average with admissible values ranging from 0 to 1: $\dot{\epsilon}_n^{\text{avg}} = \text{SRFILT} \times \dot{\epsilon}_{n-1}^{\text{avg}} + (1 - \text{SRFILT}) \times \dot{\epsilon}_n$
D1	Johnson & Cook failure parameter d_1
D2	Johnson & Cook failure parameter d_2
D3	Johnson & Cook failure parameter d_3
D4	Johnson & Cook rate dependent failure parameter d_4
D1C	Johnson & Cook damage threshold parameter d_{1c}
D2C	Johnson & Cook damage threshold parameter d_{2c}

Remarks:

Two different I_1 - J_2 yield criteria for isotropic plasticity can be defined by parameter FLG:

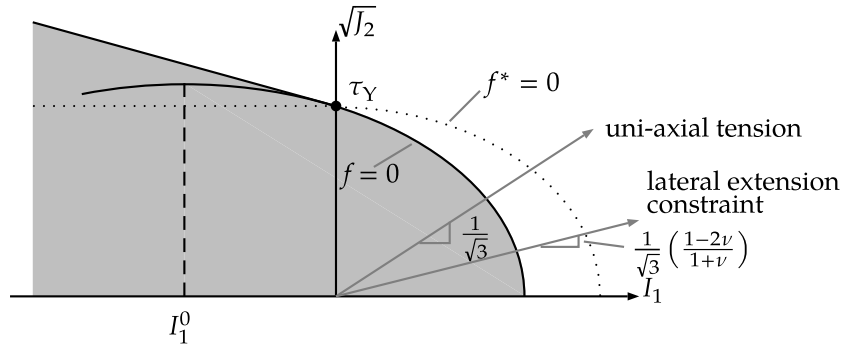

Figure M252-1. Yield function f and plastic flow potential f^*

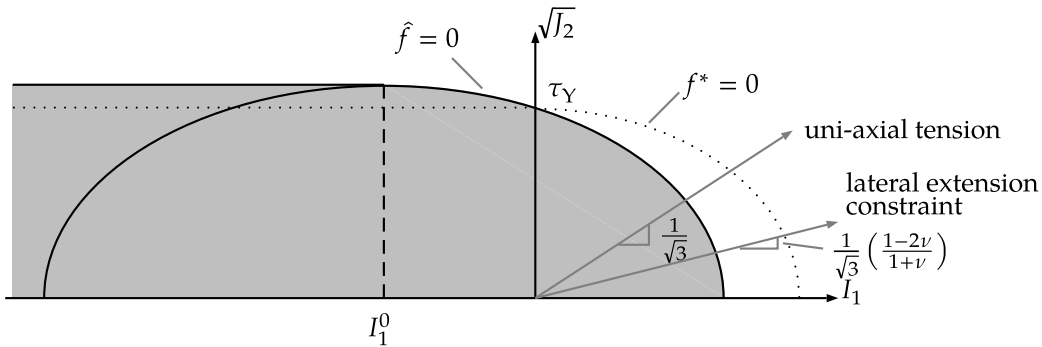

Figure M252-2. Yield function \hat{f} and plastic flow potential f^*

1. FLG = 0 is used for the yield criterion f which is changed at the case of hydrostatic pressure $I_1 = 0$ into a nonlinear *Drucker & Prager* model (DP)

$$f := \frac{J_2}{(1-D)^2} + \frac{1}{\sqrt{3}} a_1 \tau_0 \frac{I_1}{1-D} + \frac{a_2}{3} \left\langle \frac{I_1}{1-D} \right\rangle^2 - \tau_Y^2 = 0$$

with the *Macauley* bracket $\langle \bullet \rangle$, the first invariant of the stress tensor $I_1 = \text{tr } \sigma$, and the second invariant of the stress deviator $J_2 = (1/2)\text{tr}(\mathbf{s})^2$ (see [Figure M252-1](#)).

2. FLG = 2 is used for the yield criterion \hat{f} which is changed at the vertex into the deviatoric *von Mises* yield function (see [Figure M252-2](#)) and is used for conservative calculation in case of missing uniaxial compression or combined compression and shear experiments:

$$\hat{f} := \frac{J_2}{(1-D)^2} + \frac{a_2}{3} \left\langle \frac{I_1}{1-D} + \frac{\sqrt{3} a_1 \tau_0}{2 a_2} \right\rangle^2 - \left(\tau_Y^2 + \frac{a_1^2 \tau_0^2}{4 a_2} \right) = 0 .$$

The yield functions f and \hat{f} are formulated in terms of the effective stress tensor

$$\tilde{\sigma} = \sigma / (1 - D)$$

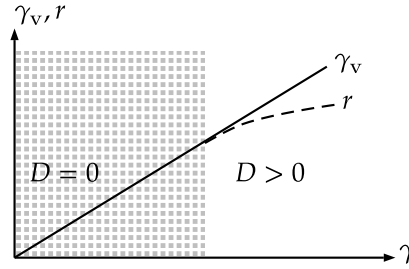

Figure M252-3. Accumulated plastic strain γ_v and damage plastic strain r as a function of strain γ

and the isotropic material damage D according to the continuum damage mechanics in Lemaitre [1992]. The stress tensor σ is defined in terms of the elastic strain ϵ^e and the isotropic damage D :

$$\sigma = (1 - D)\mathbb{C}\epsilon^e .$$

The continuity $(1 - D)$ in the elastic constitutive equation above degrades the fourth order elastic stiffness tensor \mathbb{C} ,

$$\mathbb{C} = 2G \left(\mathbb{I} - \frac{1}{3}\mathbf{1}\otimes\mathbf{1} \right) + K \mathbf{1}\otimes\mathbf{1}$$

with shear modulus G , bulk modulus K , fourth order identity tensor \mathbb{I} , and second order identity tensor $\mathbf{1}$. The plastic strain rate $\dot{\epsilon}^P$ is given by the non-associated flow rule

$$\dot{\epsilon}^P = \lambda \frac{\partial f^*}{\partial \sigma} = \frac{\lambda}{(1 - D)^2} \left(\mathbf{s} + \frac{2}{3}a_2^* \langle I_1 \rangle \mathbf{1} \right)$$

with the potential f^* and an additional parameter $a_2^* < a_2$ to reduce plastic dilatancy.

$$f^* := \frac{J_2}{(1 - D)^2} + \frac{a_2^*}{3} \left\langle \frac{I_1}{1 - D} \right\rangle^2 - \tau_Y^2$$

The plastic arc length $\dot{\gamma}_v$ characterizes the inelastic response of the material and is defined by the Euclidean norm:

$$\dot{\gamma}_v := \sqrt{2 \operatorname{tr}(\dot{\epsilon}^P)^2} = \frac{2\lambda}{(1 - D)^2} \sqrt{J_2 + \frac{2}{3}(a_2^* \langle I_1 \rangle)^2} .$$

In addition, the arc length of the damage plastic strain rate \dot{r} is introduced by means of the arc length $\dot{\gamma}_v$ and the continuity $(1 - D)$ as in Lemaitre [1992], where $\tilde{I}_1 = I_1/(1 - D)$ and $\tilde{J}_2 = J_2/(1 - D)^2$ are the effective stress invariants (see Figure M252-3).

$$\dot{r} := (1 - D)\dot{\gamma}_v = 2\lambda \sqrt{\tilde{J}_2 + \frac{2}{3}(a_2^* \langle \tilde{I}_1 \rangle)^2}$$

The rate-dependent yield strength for shear τ_Y can be defined by two alternative expressions. The first representation is an analytic expression for τ_Y :

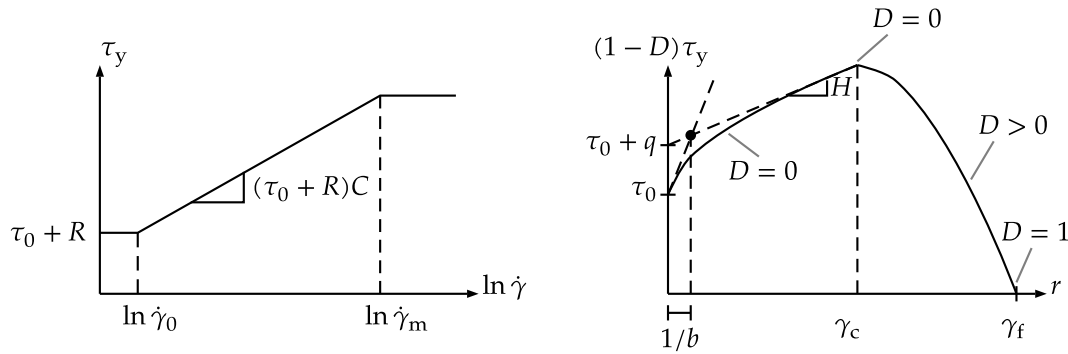

Figure M252-4. Rate-dependent tensile strength τ_Y as a function of effective strain rate $\dot{\gamma}$ (left) and effective damage plastic strain r (right)

$$\tau_Y = (\tau_0 + R) \left[1 + C \left(\left\langle \ln \frac{\dot{\gamma}}{\dot{\gamma}_0} \right\rangle - \left\langle \ln \frac{\dot{\gamma}}{\dot{\gamma}_m} \right\rangle \right) \right], \text{ with } \dot{\gamma} = \sqrt{2 \text{tr}(\dot{\epsilon})^2},$$

where the first factor $(\tau_0 + R)$ in τ_Y is given by the static yield strength with the initial yield τ_0 and the non-linear hardening contribution

$$R = q[1 - \exp(-br)] + Hr.$$

The second factor [...] in τ_Y describes the rate dependency of the yield strength by a modified Johnson & Cook approach with the reference strain rates $\dot{\gamma}_0$ and $\dot{\gamma}_m$ which limit the shear strength τ_Y (see [Figure M252-4](#)).

The second representation of the yield strength τ_Y is the table definition LCSS, where hardening can be defined as a function of plastic strain, strain rate, and temperature.

Toughened structural adhesives show distortional hardening under plastic flow, that is, the yield surface changes its shape. This formative hardening can be phenomenological described by simple evolution equations of parameters $a_1 = \hat{a}_1(r) \wedge a_2 = \hat{a}_2(r)$ in the yield criterions f with the initial values a_{10} and a_{20} :

$$a_1 = \hat{a}_1(r) \wedge \dot{a}_1 = a_1^H \dot{r}$$

$$a_2 = \hat{a}_2(r) \wedge a_2 \geq 0 \wedge \dot{a}_2 = a_2^H \dot{r}$$

The parameters a_1^H and a_2^H can take positive or negative values as long as the inequality $a_2 \geq 0$ is satisfied. The criterion $a_2 \geq 0$ ensures an elliptic yield surface. The yield criterion \hat{f} uses only the initial values $a_1 = a_{10}$ and $a_2 = a_{20}$ without the distortional hardening.

The empirical isotropic damage model D is based on the approach in Lemaitre [1985]. Two different evolution equations $\dot{D}(r, \dot{r})$ and $\dot{D}(\gamma_v, \dot{\gamma}_v)$ are available (see [Figure M252-5](#)). The damage variable D is formulated in terms of the damage plastic strain rate \dot{r} (DOPT = 0)

$$\dot{D} = \hat{D}(r, \dot{r}) = n \left\langle \frac{r - \gamma_c}{\gamma_f - \gamma_c} \right\rangle^{n-1} \frac{\dot{r}}{\gamma_f - \gamma_c}$$

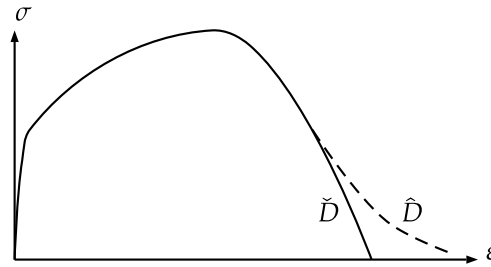

Figure M252-5. Influence of DOPT on damage softening

or of the plastic arc length $\dot{\gamma}_v$ (DOPT = 1)

$$\dot{D} = \dot{D}(\gamma_v, \dot{\gamma}_v) = n \left\langle \frac{\gamma_v - \gamma_c}{\gamma_f - \gamma_c} \right\rangle^{n-1} \frac{\dot{\gamma}_v}{\gamma_f - \gamma_c},$$

where r in contrast to γ_v increases non-proportionally slowly (see [Figure M252-5](#)). The strains at the thresholds γ_c and γ_f for damage initiation and rupture are functions of the triaxiality $T = \sigma_m / \sigma_{eq}$ with the hydrostatic stress $\sigma_m = I_1/3$ and the von Mises equivalent stress $\sigma_{eq} = \sqrt{3J_2}$ as in Johnson and Cook [1985].

$$\gamma_c = [d_{1c} + d_{2c} \exp(-d_3 \langle T \rangle)] \left(1 + d_4 \left\langle \ln \frac{\dot{\gamma}}{\dot{\gamma}_0} \right\rangle \right)$$

$$\gamma_f = [d_1 + d_2 \exp(-d_3 \langle T \rangle)] \left(1 + d_4 \left\langle \ln \frac{\dot{\gamma}}{\dot{\gamma}_0} \right\rangle \right)$$

The option JCFL controls the influence of triaxiality $T = \sigma_m / \sigma_{eq}$ in the pressure range for the thresholds γ_c and γ_f . JCFL = 0 makes use of the Macauley bracket $\langle T \rangle$ for the triaxiality $T = \sigma_m / \sigma_{eq}$ while JCFL = 1 omits the Macauley bracket $\langle T \rangle$.

History Variables:

History Variable #	Description
1	Damage variable, D
2	Plastic arc length, γ_v
3	Effective strain rate
4	Temperature
5	Yield stress
6	Damaged yield stress
7	Triaxiality

History Variable #	Description
8	threshold, γ_c
9	threshold, γ_f

*MAT_GENERALIZED_PHASE_CHANGE

This is Material Type 254. It is designed to model phase transformations in materials and the implied changes in the material properties. It is applicable to hot stamping, heat treatment and welding processes for a wide range of materials. It accounts for up to 24 phases and provides a list of generic phase change mechanisms for each possible phase changes. The parameters for the phase transformation laws are to be given in tabulated form.

Given the current microstructure composition, the formulation implements a temperature and strain-rate dependent elastic-plastic material with non-linear hardening behavior. Above a certain temperature, the model shows an ideal elastic-plastic behavior with no evolution of plastic strains.

The material has been implemented for solid and shell elements and is suitable for explicit and implicit analysis.

Card Summary:

Card 1. This card is required.

MID	RO	N	E	PR	MIX	MIXR	
-----	----	---	---	----	-----	------	--

Card 2. This card is required.

TASTART	TAEND	CTE			EPSINI	DTEMP	
---------	-------	-----	--	--	--------	-------	--

Card 2.1. This card is included if and only if TASTART > 0 and TAEND = 0.

XASTR	XAEND	XAIPA1	XAIPA2	XAIPA3	XAFPA	CTEANN	
-------	-------	--------	--------	--------	-------	--------	--

Card 3. This card is required.

PTLAW	PTSTR	PTEND	PTX1	PTX2	PTX3	PTX4	PTX5
-------	-------	-------	------	------	------	------	------

Card 4. This card is required.

PTTAB1	PTTAB2	PTTAB3	PTTAB4	PTTAB5	PTTAB6	PTTAB7	
--------	--------	--------	--------	--------	--------	--------	--

Card 5. This card is required.

PTEPS	PTRIP	PTLAT	POSTV	NUSHIS	GRAIN	T1PHAS	T2PHAS
-------	-------	-------	-------	--------	-------	--------	--------

Card 5.1. This card is included if and only if NUSHIS > 0.

FUSHI1	FUSHI2	FUSHI3	FUSHI4	FUSHI5	FUSHI6	FUSHI7	FUSHI8
--------	--------	--------	--------	--------	--------	--------	--------

Card 6. For each of the N phases, one parameter SIGY_i must be specified. A maximum of 10 of this card may be included. The next keyword ("**") card terminates this input.

SIGY1	SIGY2	SIGY3	SIGY4	SIGY5	SIGY6	SIGY7	SIGY8
-------	-------	-------	-------	-------	-------	-------	-------

Data Card Definitions:

Card 1	1	2	3	4	5	6	7	8
Variable	MID	RO	N	E	PR	MIX	MIXR	
Type	A	F	I	F	F	I	I	

VARIABLE**DESCRIPTION**

MID	Material identification. A unique number or label must be specified (see *PART).
RO	Mass density, ρ
N	Number of phases
E	Young's modulus: GT.0.0: Constant value is used. LT.0.0: Temperature dependent Young's modulus given by load curve or table ID = -E. Tables are used to describe a temperature dependent modulus for each phase individually.
PR	Poisson's ratio: GT.0.0: Constant value is used. LT.0.0: Temperature dependent Poisson's ratio given by load curve or table ID = -E. Tables are used to describe a temperature dependent Poisson's ratio for each phase individually.
MIX	Load curve ID with initial phase concentrations
MIXR	Load curve or table ID for mixture rule. Tables are used to define temperature dependency.

Card 2	1	2	3	4	5	6	7	8
Variable	TASTART	TAEND	CTE			EPSINI	DTEMP	
Type	F	F	I			F	F	

VARIABLE

DESCRIPTION

TASTART	Temperature start for simple linear annealing (see Remark 5). If TASTART > 0 and TAEND = 0, an enhanced annealing algorithm is used (see Remark 6). In that case, TASTART is interpreted as an anneal option, and Card 2.1 is required. Possible values for the extended anneal option are: EQ.1: Linear annealing EQ.2: JMAK
TAEND	Temperature end for simple linear annealing. See Remark 5 . If TASTART > 0 and TAEND = 0, an enhanced annealing algorithm is used. See Remark 6 .
CTE	Coefficient of thermal expansion: GT.0.0: Constant value is used. LT.0.0: Temperature dependent CTE given by load curve or table ID = -CTE. Tables give CTE as a function of temperature for each phase individually.
EPSINI	Initial plastic strains, uniformly distributed within the part
DTEMP	Maximum temperature variation within a time step. If exceeded during the analysis, a local sub-cycling is used for the calculation of the phase transformations.

Enhanced Annealing Card. Additional card for TASTART > 0 and TAEND = 0 only. See [Remark 6](#) for details.

Card 2.1	1	2	3	4	5	6	7	8
Variable	XASTR	XAEND	XAIPA1	XAIPA2	XAIPA3	XAFPA	CTEANN	
Type	F	F	I	I	I	F	F	

VARIABLE	DESCRIPTION
-----------------	--------------------

XASTR	Annealing start temperature
XAEND	Annealing end temperature
XAIP <i>i</i>	Load curve or table ID defining the <i>i</i> th parameter of the enhanced annealing option. Interpretation of the parameter depends on TASTART.
XAFPA	Scalar parameter of the enhanced annealing option if applicable. Interpretation of the parameter depends on TASTART.
CTEAN	Annealing option for thermal expansion: LT.0: CTEAN defines the upper temperature limit (cut-off temperature) for evaluation of thermal strains. EQ.0: No modification of thermal strains EQ.1: XAEND defines the upper temperature limit (cut-off temperature) for evaluation of thermal strains.

Card 3	1	2	3	4	5	6	7	8
Variable	PTLAW	PTSTR	PTEND	PTX1	PTX2	PTX3	PTX4	PTX5
Type	I	I	I	I	I	I	I	I

VARIABLE	DESCRIPTION
-----------------	--------------------

PTLAW	Table ID to define the phase transformation model as a function of source phase and target phase. The values in *DEFINE_TABLE are the phase numbers before transformation. The curves referenced by the table specify transformation model (ordinate) as a function of phase number after transformation. LT.0: transformation model used in heating EQ.0: no transformation GT.0: transformation model is used in cooling A variety of transformation models can be specified as ordinate values of the curves: EQ.1: Koinstinen-Marburger EQ.2: Johnson-Mehl-Avrami-Kolmogorov (JMAK)
-------	---

VARIABLE	DESCRIPTION
----------	-------------

EQ.3: Akerstrom (only for cooling)
 EQ.4: Oddy (only for heating)
 EQ.5: Phase Recovery I (only for heating)
 EQ.6: Phase Recovery II (only for heating)
 EQ.7: Parabolic Dissolution I (only for heating)
 EQ.8: Parabolic Dissolution II (only for heating)
 EQ.9: extended Koistinen-Marburger (only for cooling)
 EQ.12: JMAK for both cooling and heating

See [Remarks 1](#) and [2](#) for further details.

PTSTR Table ID to define start temperatures for the transformations as a function of source phase and target phase. The values in *DEFINE_TABLE are the phase numbers before transformation. The curves referenced by the table specify start temperature (ordinate) as a function of phase number after transformation (abscissa).

PTEND Table ID to define end temperatures for the transformations as a function of source phase and target phase. The values in *DEFINE_TABLE are the phase numbers before transformation. The curves referenced by the table specify end temperature (ordinate) as a function of phase number after transformation (abscissa).

PTXi Table ID defining the i^{th} scalar-valued phase transformation parameter as function of source phase and target phase (see [Remark 2](#) and [Table M254-1](#) to determine which parameters apply). The values in *DEFINE_TABLE are the phase numbers before transformation. The curves referenced by the table specify scalar parameter (ordinate) as a function of phase number after transformation (abscissa).

Card 4	1	2	3	4	5	6	7	8
Variable	PTTAB1	PTTAB2	PTTAB3	PTTAB4	PTTAB5	PTTAB6	PTTAB7	
Type	I	I	I	I	I	I	I	

VARIABLE	DESCRIPTION
----------	-------------

PTTABi Table ID for a 3D table defining the i^{th} tabulated phase transformation parameter as function of source phase and target phase (see

VARIABLE

DESCRIPTION

Remark 2 and Table M254-1 to determine which parameters apply).

The values in *DEFINE_TABLE_3D are the phase numbers before transformation. The values in the 2D tables referenced by *DEFINE_TABLE_3D are the phase numbers after transformation. The curves referenced by the 2D tables specify tabulated parameter (ordinate) as a function of either temperature or temperature rate (abscissa).

Card 5	1	2	3	4	5	6	7	8
Variable	PTEPS	PTRIP	PTLAT	POSTV	NUSHIS	GRAIN	T1PHAS	T2PHAS
Type	I	F	I	I	I	F	F	F

VARIABLE

DESCRIPTION

PTEPS

Table ID defining transformation induced strains.

If ID of 2D table

The values in *DEFINE_TABLE are the phase numbers before transformation. The curves referenced by the table specify strains (ordinate) as a function of phase number after transformation (abscissa).

If ID of 3D table

The values in *DEFINE_TABLE_3D are the phase numbers before transformation. The values in the 2D tables referenced by *DEFINE_TABLE_3D are the phase number after transformation. The curves referenced by the 2D tables specify induced strains as a function of temperature.

PTRIP

Flag for transformation induced plasticity (TRIP). Algorithm active for positive values of PTRIP.

PTLAT

Table ID defining transformation induced heat generation (latent heat).

If ID of 2D table

The values in *DEFINE_TABLE are the phase numbers before transformation. The curves referenced by the table

VARIABLE	DESCRIPTION
	<p>specify heat values (ordinate) versus phase number after transformation (abscissa).</p> <p><u>If ID of 3D table</u></p> <p>The values in *DEFINE_TABLE_3D are the phase numbers before transformation. The values in the 2D tables referenced by *DEFINE_TABLE_3D are the phase number after transformation. The curves referenced by the 2D tables specify induced heat as function of temperature.</p>
POSTV	Define additional pre-defined history variables that might be useful for post-processing. See Remark 4 .
NUHIS	Number of additional user defined history variables. For details see Remarks 3 and 4 .
GRAIN	Initial grain size
T1PHAS	Lower temperature limit for cooling rate evaluation. Cooling rate can be used as input for user defined variables.
T2PHAS	Upper temperature limit for cooling rate evaluation. Cooling rate can be used as input for user defined variables.

User History Card. Additional card for NUSHIS > 0 only.

Card 5.1	1	2	3	4	5	6	7	8
Variable	FUSHI1	FUSHI2	FUSHI3	FUSHI4	FUSHI5	FUSHI6	FUSHI7	FUSHI8
Type	I	I	I	I	I	I	I	I

VARIABLE	DESCRIPTION
FUSHI <i>i</i>	Function ID for user defined history variables. See Remarks 3 and 4 .

Phase Yield Stress Cards. For each of the N phases, one parameter $SIGY_i$ must be specified. A maximum of 10 of this card may be included. The next keyword ("*") card terminates this input.

Card 6	1	2	3	4	5	6	7	8
Variable	SIGY1	SIGY2	SIGY3	SIGY4	SIGY5	SIGY6	SIGY7	SIGY8
Type	I	I	I	I	I	I	I	I

VARIABLE**DESCRIPTION** $SIGY_i$ Load curve or table ID for hardening of phase i .If load curve ID

Input yield stress as a function of effective plastic strain.

If table ID of 2D table

Input temperatures as table values and hardening curves (yield stress as a function of effective plastic strain) as targets for those temperatures.

If table ID of 3D table

Input temperatures as main table values and strain rates as values for the sub-tables. Hardening curves (yield stress as a function of effective plastic strain) are targets for those strain rates.

Remarks:

1. **Phase Transformation Matrix.** All data defining the microstructure evolution is expected to be given in a tabular form. The input is structured as a two-dimensional matrix containing one row for any starting phase and one row for any target phase. The basic structure is depicted in the following table:

		Target Phase				
		1	2	3	...	N
Starting Phase	1					
	2					
	3					
	...					
	N					

For the input in Card 3, the entry at position ij of this matrix is interpreted as scalar data used for the transformation from phase i to phase j . This could for example be the transformation law or the start time. In LS-DYNA, such a matrix is defined by the keyword *DEFINE_TABLE(_2D). The abscissa values are the starting phase IDs. Each load curve (*DEFINE_CURVE) that is referenced consequently defines one row of the matrix.

Some of the implemented transformation models require input data that is a function of temperature, temperature rate, equivalent plastic strain or other values. The input of this data has the same basic input structure as the scalar values, but the matrix entries are now load curve IDs. Therefore, the input is a three-dimensional table (*DEFINE_TABLE_3D) and each row of the matrix is represented by a two-dimensional table itself defined by *DEFINE_TABLE(_2D).

2. **Phase Transformation Models.** This material features temperature and phase composition dependent elastic plastic behavior. The phase composition is determined using a list of generic phase transformation mechanisms you can choose from for each of the possible phase transformations. So far, eight different transformation models have been implemented to describe the transition from source phase concentration, x_a , to target phase concentration, x_b . [Table M254-1](#) at the end of this remark summarizes the input parameters necessary for the individual models.

- a) *Koistinen-Marburger (KM), law 1.*

The KM formulation is tailored for non-diffusive transformations. In the most basic and commonly used version, the temperature dependent amount of the target phase is computed as

$$x_b = (x_a + x_b)(1.0 - e^{-\alpha_{\text{KM}}(T_{\text{start}} - T)}) .$$

PTXI defines the so-called Koistinen-Marburger factor, α_{KM} .

- b) *Generalized Johnson-Mehl-Avrami-Kolmogorov (JMAK), law 2.*

This is a widely used model for diffusive phase transformation. In literature, often the incremental form of the JMAK equation is given for an isothermal, incomplete transformation:

$$x_b = x_{\text{eq}}(T)(x_a + x_b) \left(1 - e^{-\left(\frac{t}{\tau(T)}\right)^{n(T)}} \right) .$$

In the previous equation, exponent, n ; equilibrium concentration, x_{eq} ; and relaxation time, τ , are functions of the temperature.

In this material model, the differential form of the JMAK equation is employed which makes the model readily applicable for non-isothermal processes:

$$\frac{dx_b}{dt} = n(T)(k_{ab}x_a - k'_{ab}x_b) \left(\ln \left(\frac{k_{ab}(x_a + x_b)}{k_{ab}x_a - k'_{ab}x_b} \right) \right)^{\frac{n(T)-1.0}{n(T)}} ,$$

In this evolution equation, the following factors are defined:

$$k_{ab} = \frac{x_{\text{eq}}(T)}{\tau(T) \times \alpha(\varepsilon^p)} f(\dot{T})$$

$$k'_{ab} = \frac{1.0 - x_{\text{eq}}(T)}{\tau(T) \times \alpha(\varepsilon^p)} f'(\dot{T})$$

As user input, load curve data for the exponent, $n(T)$, is defined in PTTAB1, the equilibrium concentration, $x_{\text{eq}}(T)$, in PTTAB2, and the relaxation time, $\tau(T)$, in PTTAB3. This model is a generalized JMAK approach that features additional parameters, such as the temperature rate correction factors, $f(\dot{T})$ and $f'(\dot{T})$, given in PTTAB4 and PTTAB5, respectively. As an optional parameter an accelerator $\alpha(\varepsilon^p)$ for the transformation can be defined as function of equivalent plastic strain in PTTAB6. If not defined, a constant value of 1.0 is assumed.

Like the Koistinen-Marburger case, a temperature dependent equilibrium concentration, $x_{\text{eq},a'}$ of the source phase can optionally be defined. If

defined in PTTAB7, the transformation is only active if the source phase fraction exceeds the equilibrium, meaning $x_a > x_{eq,a}$.

Note that the JMAK evolution can not only be activated by a choice of -2 (heating) and 2 (cooling), but also by choosing the law to be 12. In that case, the sign of the temperature rate is not checked, and the model is always active if the temperature is in the temperature window defined by the start and end temperature of the transformation.

c) *Kirkaldy, law 3.*

Similar to the implementation of *MAT_244, the transformation for cooling phases can be computed by the evolution equation:

$$\frac{dX_b}{dt} = 2^{0.5(G-1)} f(C) (T_{start} - T)^{n_T} D(T) \frac{X_b^{n_1(1.0-X_b)} (1.0 - X_b)^{n_2 X_b}}{Y(X_b)},$$

formulated in the normalized phase concentration

$$X_b = \frac{x_b}{x_{eq}(T)}.$$

In contrast to *MAT_244, the parameters for the evolution equation are not determined from the chemical composition of the material but defined directly as user input. The scalar data in PTX1 to PTX4 are interpreted as $f(C)$, n_T , n_1 , and n_2 . Tabulated data for $D(T)$, $Y(X_b)$, and $x_{eq}(T)$ are given in PTTAB1 to PTTAB3.

d) *Oddy, law 4.*

For phase transformation in heating, the equation of Oddy can be used, which can be interpreted as a simplified JMAK relation and reads as

$$\frac{dx_b}{dt} = n \frac{x_a}{c_1 (T - T_{start})^{-c_2}} \left(\ln \left(\frac{(x_a + x_b)}{x_a} \right) \right)^{\frac{n-1.0}{n}}.$$

Its application requires the input of three scalar parameters, n , c_1 , and c_2 , that are read from the respective positions in the tables in PTX1 to PTX3.

e) *Phase recovery I, law 5.*

This phase transformation law is motivated by the recovery of the β -phase and α -phase from martensitic α -phase in titanium alloys and is a generalization of the algorithms described in the literature for this process.

The transformation takes place if and only if the amount of the target phase is below a user-defined, temperature dependent threshold, x_b^{tr} . This threshold can be defined in PTTAB3.

For $x_b < x_b^{\text{tre}}$, the transformation scheme comprises three steps. First, a temperature dependent equilibrium fraction for the starting phase is calculated based on an incomplete KM equation:

$$x_{\text{eq},a} = (x_a + x_b - x_{\text{inc}})(1.0 - e^{-\alpha_{\text{KM}}(T_{\text{KM},s} - T)}) .$$

The KM-parameter α_{KM} and the start temperature $T_{\text{KM},s}$ must be given in PTX1 and PTX2, respectively. The incompleteness parameter x_{inc} is a function of temperature defined in PTTAB4.

Second, if the current fraction of the starting phase x_a exceeds the calculated equilibrium concentration $x_{\text{eq},a}$, a diffusional process follows. It is described by a JMAK approach. Its incremental form for an isothermal process is given by

$$x_a = x_{\text{eq},a} + (x_a + x_b - x_{\text{eq},a})e^{-\left(\frac{t}{\tau(T)}\right)^{n(T)}} .$$

Naturally, a differential form of this equation is used in the model in order to be applicable to non-isothermal situations. The final calculated change Δx_a is identified with the formation of a recovery phase $x_a^r = -\Delta x_a$. The parameters for the JMAK equation are given in PTTAB1 (n) and PTTAB2 (τ).

Third, some of the recovery phase is partially transformed into the target phase:

$$\Delta x_b = \gamma(T)x_a^r .$$

The quotient $\gamma(T)$ can be defined in PTTAB5.

f) *Phase recovery II, law 6.*

This is the second part of the recovery and can only be defined if the previous transformation law (law 5) has also been defined with the same starting phase. This second step aims to transform the remaining fraction of the virtual, recovery phase x_a^r into the physical phases defined in the material.

In order to allow for the definition of more than two target phases for one recovery process, an optional parameter $\eta(T)$ can be defined as the only input of this transformation in PTTAB1. It is used to control the transformation by

$$\Delta x_b = \eta(T)x_a^r .$$

Note that x_a^r here refers to the complete fraction of the recovery phase as calculated by the JMAK approach. If the parameter is not defined, then the remainder of the virtual phase fraction is completely transformed.

g) *Parabolic growth I, law 7.*

The transformation laws 7 and 8 model the subsequent dissolution of a group of phases into one common target phase. The remaining fraction of the group after dissolution within a time step is denoted by x_{diss} . The groups are identified by a group ID that is here defined in PTX1.

You can define a dissolution function, f_{diss} , and a critical time, t_{crit} . These values are expected to be functions of temperature and are defined in PT-TAB3 and PTTAB4, respectively. Based on those and the temperature dependent equilibrium concentration $x_{\text{eq},b}$ (PTTAB2), a characteristic dissolution time, t_{diss} , can be calculated as

$$t_{\text{diss}} = \left(\frac{x_b(T)}{x_b^{\text{eq}}(T)} \right)^2 t_{\text{crit}}(T) .$$

Depending on the relative size of the step increment, Δt , with respect to the critical and characteristic dissolution time, the remaining group fraction x_{diss} is calculated as

$$x_{\text{diss}} = \begin{cases} 1 - x_b^{\text{eq}}(T) f(T) \sqrt{\Delta t + t_{\text{diss}}(T)}, & \text{for } \Delta t + t_{\text{diss}} < t_{\text{crit}} \\ 1 - x_b^{\text{eq}}(T), & \text{otherwise} \end{cases}$$

Now, the fraction x_a (the transformation of which is defined by law 7) is always assumed to be the first member of the group to be dissolved. It is algorithmically assured that there cannot be an increase in fraction x_a .

h) *Parabolic growth II, law 8.*

This law cannot be defined separately, but simulates the dissolution of the further members of the group already defined for a transformation with law 7. Naturally, the group ID must also be referenced here, and it is again given in PTX1. Furthermore, in the case of three or more members within a group the order in which the fractions are to be dissolved must be defined. For that purpose, the position in the group is defined in PTX2.

i) *Extendenden Koistinen-Marburger, law 9.*

This extension to the standard Koistinen-Marburger (law 1) is motivated by the application of the material formulation to titanium and is only available in cooling.

An equilibrium concentration $x_{\text{eq},a}$ of the source phase can be defined as function of the current temperature in parameter PTTAB1. The transformation is only active if the source phase fraction exceeds the equilibrium, meaning $x_a > x_{\text{eq},a}$.

Furthermore, an incomplete transformation is possible in case of relatively slow cooling rates. For this purpose, you can define two rate limits $\dot{T}_{lim,1}$ and $\dot{T}_{lim,2}$ in PTX2 and PTX3, respectively, and an incompleteness parameter $x_{inc}(T)$ as a function of temperature in PTTAB2. The corresponding equation for the transformation then is given by:

$$x_b = \begin{cases} (x_a + x_b)(1.0 - e^{-\alpha_{KM}(T_{start}-T)}) & , \text{for } \dot{T} < \dot{T}_{lim,1} \\ (x_a + x_b - x_{inc})(1.0 - e^{-\alpha_{KM}(T_{start}-T)}) & , \text{for } \dot{T}_{lim,1} < \dot{T} < \dot{T}_{lim,2} \end{cases}$$

A summary of input parameters for the different material laws is given in the following table. If not stated otherwise, the parameters in the tabular data PTTABi are expected to be functions of the current temperature, T .

PTLAW #	1	2/12	3	4	5	6	7	8	9
PTX1	α_{KM}		$f(C)$	n	α_{KM}		GID	GID	α_{KM}
PTX2			n_T	c_1	$T_{KM,s}$			POS	$\dot{T}_{lim,1}$
PTX3			n_1	c_2					$\dot{T}_{lim,2}$
PTX4			n_2						
PTTAB1		n	D		n	η	x_b^{tre}		$x_{eq,a}$
PTTAB2		x_{eq}	$Y(X_b)$		τ		$x_{eq,b}$		x_{inc}
PTTAB3		τ	τ		x_b^{tre}		f_{diss}		
PTTAB4		$f(\dot{T})$			x_{inc}		t_{crit}		
PTTAB5		$f'(\dot{T})$			γ				
PTTAB6		$\alpha(\epsilon^{pl})$							
PTTAB7		$x_{eq,a}$							

Table M254-1. Summary of input parameters for the various laws

- User-Defined History Data.** You can define up to eight additional history variables that are added to the list of history variables starting at position 31 (see [Remark 4](#)). These values can for example be used to evaluate the hardness of the material based on different formulas given in the literature.

The additional variables are to be given by respective *DEFINE_FUNCTION keywords in the input as functions of the current time, the user defined histories themselves, the current phase concentrations, the current temperature, the peak temperature, the average temperature rate between T2PHASE and T1PHASE, the current yield stress, the stress tensor, and the current values for the equivalent plastic strain of the individual phases.

For example, if all 24 phases are used ($N = 24$) and eight additional history variables ($NUSHIS = 8$) are defined, a function declaration could look as follows:

```
*DEFINE_FUNCTION
1,user defined history 1
uhist(time,usrhst1,usrhst2,...,usrhst8,phase1,
phase2,...,phase24,T,Tpeak,Trate,sigy,
sigma1,sigma2,...,sigma6,
epspl1,epspl2,...,epspl24)= ...
```

In contrast, for four considered phases ($N = 4$) and two additional histories ($NUSHIS = 2$) the keyword input could be

```
*DEFINE_FUNCTION
2,user defined history 1
uhist(time,usrhst1,usrhst2,phase1,phase2,phase3,phase4,
T,Tpeak,Trate,sigy,sigma1,sigma2,...,sigma6,epspl1,epspl2,
epspl3,epspl4)= ...
```

4. **History Values.** To be able to post-process values of history variables, fields NEIPS (shells) or NEIPH (solids) must be defined on *DATABASE_EXTENT_BINARY.

Aside from the user-defined history variables discussed in [Remark 3](#), this material formulation can output additional pre-defined history values for post-processing. The input value of field POSTV defines the data to be written. Its value is calculated as

$$POSTV = a_1 + 2 a_2 + 4 a_3 + 8 a_4$$

Each flag a_i is a binary number (can be either 1 or 0) and corresponds to one particular post-processing variable according to the following table. This table also shows the order of output as well as the number of extra history variables associated with the particular flag. The values of these user-defined histories are reset when the temperature is in the annealing range.

Flag	Description	Variables	# Hist
a_1	Accumulated thermal strain	ε_T	1
a_2	Accumulated strain tensor	ε	6
a_3	Plastic strain tensor	ε_p	6
a_4	Equivalent strain	ε_{VM}	1

In total NXH extra variables are required depending on the choice of parameter POSTV. For example, the maximum number of additional variables is NXH = 14 for POSTV = 15.

A complete list of history variables for the material is given in the following table. "Position" refers to the history variable number as listed by LS-PrePost when post-processing the d3plot database. The value of N indicates the number of phases accounted for in the model.

History Variable #	Description
$1 \rightarrow N$	Phase concentrations
$N + 1$	Maximum temperature
$N + 2$	Cooling rate between T2PHAS and T1PHAS
$N + 3$	Yield stress
$N + 4$	Young's modulus
$N + 5$	Grain size
$N + 6$	Indicator of plastic behavior
$N + 7 \rightarrow N + 6 + NUSHIS$	User defined history variables
$N + 7 + NUSHIS$	Current temperature

History Variable #	Description
N + 8 + NUHIS → N + 7 + NUHIS + NXH	Post-process history data as described in the preceding table
N + 8 + NUHIS + NXH → 2 × N + 7 + NUHIS + NXH	Effective plastic strain for each phase in the microstructure

5. **Simple Annealing.** When the temperature reaches the start annealing temperature TASTART, the material starts assuming its virgin properties. Beyond the start annealing temperature, it behaves as an ideal elastic-plastic material but with no evolution of plastic strains.

For non-zero values of both TASTART and TAEND a simple annealing strategy is used. The resetting of effective plastic properties in the annealing temperature interval is done by modifying the effective plastic strain for each phase as

$$\varepsilon_p^n = \varepsilon_{p,start}^n \frac{T_a^{\text{end}} - T}{T_a^{\text{end}} - T_a^{\text{start}}},$$

where $\varepsilon_{p,start}^n$ is the plastic strain for phase n at the beginning of the annealing process.

6. **Enhanced Annealing.** For a positive value of TASTART and TAEND = 0, an enhanced annealing strategy is employed. It requires the input of an additional keyword card.

Above the annealing start temperature T_a^{start} , defined by XASTR, the material behaves as an ideal-plastic material, but instead of an evolution of the plastic strains, the equivalent plastic strain ε^p is reduced by a scale factor $\alpha(T, t)$ within the annealing temperature window

$$\varepsilon_p^n = \varepsilon_{p,start}^n (\alpha(T, t)) .$$

The base value $\varepsilon_{p,start}^n$ refers to the equivalent plastic strain found in the phase, n , when the temperature reaches the annealing start temperature for the first time. The algorithm used to determine the value of α depends on the annealing option TASTART.

- a) *Linear annealing.* For TASTART = 1 a linear relation between temperature and the annealing effect is assumed, similar to the simple annealing option discussed above. But in this case an incomplete reset of the equivalent plastic strain data is possible. The scale factor, α , is a function of temperature and is given by

$$\alpha = \frac{T_a^{\text{end}} - T}{T_a^{\text{end}} - T_a^{\text{start}}} + \alpha_{\text{eq}} \frac{T - T_a^{\text{start}}}{T_a^{\text{end}} - T_a^{\text{start}}}$$

Here, the end temperature, T_a^{end} , is defined by XAEND and the newly introduced incompleteness factor, α_{eq} , as scalar input data in XAFPA.

- b) *Johnson-Mehl-Avrami-Kolmogorov (JMAK)*. For TASTART = 2, the evolution of the scale factor follows a JMAK-type approach. For isothermal situations and assuming a start time for the process of 0.0, an incremental form can be explicitly stated a

$$\alpha = \alpha_{\text{eq}}(T) + \left(1 - \alpha_{\text{eq}}(T)\right) e^{-\left(\frac{t}{\tau(T)}\right)^{n(T)}}.$$

In the last equation, $n(T)$ denotes the exponent for the differential equation, $\tau(T)$ the relaxation time and $\alpha_{\text{eq}}(T)$ denotes the limit value for the scale factor for infinitely long processes. All of those are functions of temperature and, thus, require the input of load curve IDs in XAIPA1 ($n(T)$), XAIPA2 ($\alpha_{\text{eq}}(T)$) and XAIPA3 ($\tau(T)$).

In the material implementation a differential form of the JMAK approach is invoked, which makes the formulation applicable to non-isothermal processes as well as independent of the start time of annealing.

*MAT_PIECEWISE_LINEAR_PLASTIC_THERMAL

This is Material Type 255, an isotropic elastoplastic material with thermal properties. It can be used for both explicit and implicit analyses. Young’s modulus and Poisson’s ratio can depend on the temperature by defining two load curves. Moreover, the yield stress in tension and compression are given as load curves for different temperatures by using two tables. The thermal coefficient of expansion can be given as a constant ALPHA or as a load curve LALPHA. A positive curve ID for LALPHA models the instantaneous thermal coefficient, whereas a negatives curve ID models the thermal coefficient relative to a reference temperature, TREF. The strain rate effects are modelled with the Cowper-Symonds rate model with the parameters C and P on Card 1. Failure can be based on effective plastic strain or using the *MAT_ADD_EROSION keyword.

Card 1	1	2	3	4	5	6	7	8
Variable	MID	RO	E	PR	C	P	FAIL	TDEL
Type	A8	F	F	F	F	F	F	F

Card 2	1	2	3	4	5	6	7	8
Variable	TABIDC	TABIDT	LALPHA		VP			
Type	I	I	I		F			

Card 3	1	2	3	4	5	6	7	8
Variable	ALPHA	TREF						
Type	F	F						

VARIABLE

DESCRIPTION

MID	Material identification. A unique number or label not exceeding 8 characters must be specified.
RO	Mass density

VARIABLE	DESCRIPTION
E	<p>Young's modulus:</p> <p>LT.0.0: E is a load curve ID where E is given as a function of temperature, T. The curve consists of (T, E) data pairs.</p> <p>GT.0.0: constant</p>
PR	<p>Poisson's ratio.</p> <p>LT.0.0: PR is a load curve ID for Poisson's ratio as a function of temperature.</p> <p>GT.0.0: constant</p>
C	Strain rate parameter. See Remark 1 .
P	Strain rate parameter. See Remark 1 .
FAIL	Effective plastic strain when the material fails. User defined failure subroutine, <code>matusr_24</code> in <code>dyn21.F</code> , is called to determine failure when <code>FAIL < 0</code> . Note that for solids the <code>*MAT_ADD_EROSION</code> can be used for additional failure criteria.
TDEL	A time step less than TDEL is not allowed. A step size less than TDEL will trigger automatic element deletion. This option is ignored for implicit analyses.
TABIDC	Table ID for yield stress in compression; see Remark 2 .
TABIDT	Table ID for yield stress in tension; see Remark 2 .
LALPHA	<p>Load curve ID for thermal expansion coefficient as a function of temperature:</p> <p>GT.0: the instantaneous thermal expansion coefficient based on the following formula:</p> $d\varepsilon_{ij}^{\text{thermal}} = \alpha(T)dT\delta_{ij}$ <p>LT.0: the thermal coefficient is defined relative a reference temperature <code>TREF</code>, such that the total thermal strain is given by:</p> $\varepsilon_{ij}^{\text{thermal}} = \alpha(T)(T - T_{\text{ref}})\delta_{ij}$ <p>With this option active, <code>ALPHA</code> is ignored.</p>
VP	<p>Formulation for rate effects; see Remarks 1 and 2.</p> <p>EQ.0.0: effective total strain rate (default)</p>

VARIABLE	DESCRIPTION
	NE.0.0: effective plastic strain rate
ALPHA	Coefficient of thermal expansion
TREF	Reference temperature, which is required if and only if LALPHA is given with a negative load curve ID

Remarks:

1. **Strain Rate Effects.** The strain rate effect is modelled by using the Cowper and Symonds model which scales the yield stress according to the factor

$$1 + \left(\frac{\dot{\epsilon}_{\text{eff}}}{C} \right)^{1/P}$$

where $\dot{\epsilon}_{\text{eff}} = \sqrt{\text{tr}(\dot{\epsilon}\dot{\epsilon}^T)}$ is the Euclidean norm of the total strain rate tensor if $VP = 0$ (default), otherwise $\dot{\epsilon}_{\text{eff}} = \dot{\epsilon}_{\text{eff}}^P$.

2. **Yield Stress Tables.** The dependence of the yield stresses on the effective plastic strains is given in two tables.
 - a) TABIDC gives the behaviour of the yield stresses in compression
 - b) TABIDT gives the behaviour of the yield stresses in tension.

The table indices consist of temperatures, and at each temperature a yield stress curve must be defined.

Both TABIDC and TABIDT can be 3D tables, in which temperatures indexes the main table and strain rates are defined as values for the sub tables with hardening curves as targets for those strain rates. If the same yield stress should be used in both tension and compression, only one table needs to be defined and the same TABID is put in position 1 and 2 on Card 2. If $VP = 0$, effective total strain rates are used in the 3D tables, otherwise plastic strain rates.

3. **History Variables.** Two history variables are added to the d3plot file, the Young's modulus and the Poisson's ratio, respectively. They can be requested through the *DATABASE_EXTENT_BINARY keyword.
4. **Nodal Temperatures.** Nodal temperatures must be defined by using a coupled analysis or some other way to define the temperatures, such as *LOAD_THERMAL_VARIABLE or *LOAD_THERMAL_LOAD_CURVE.

***MAT_AMORPHOUS_SOLIDS_FINITE_STRAIN**

This is Material Type 256, an isotropic elastic-viscoplastic material model intended to describe the behaviour of amorphous solids such as polymeric glasses. The model accurately captures the hardening-softening-hardening sequence and the Bauschinger effect experimentally observed at tensile loading and unloading respectively. The formulation is based on hyperelasticity and uses the multiplicative split of the deformation gradient F which makes it naturally suitable for both large rotations and large strains. Stress computations are performed in an intermediate configuration and are therefore preceded by a pull-back and followed by a push-forward. The model was originally developed by Anand and Gurtin [2003] and implemented for solid elements by Bonnaud and Faleskog [2019].

Card 1	1	2	3	4	5	6	7	8
Variable	MID	RO	K	G	MR	LL	NU0	M
Type	A	F	F	F	F	F	F	F

Card 2	1	2	3	4	5	6	7	8
Variable	ALPHA	H0	SCV	B	ECV	G0	S0	
Type	F	F	F	F	F	F	F	

VARIABLE**DESCRIPTION**

MID	Material identification. A unique number or label must be specified (see *PART).
RO	Mass density
K	Bulk modulus
G	Shear modulus
MR	Kinematic hardening parameter, μ_R (see Remark 1)
LL	Kinematic hardening parameter, λ_L (see Remark 1)
NU0	Creep parameter, ν_0 (see Remark 2)
M	Creep parameter, m (see Remark 2)

VARIABLE	DESCRIPTION
ALPHA	Creep parameter, α (see Remark 2)
H0	Isotropic hardening parameter, h_0 (see Remark 3)
SCV	Isotropic hardening parameter, s_{cv} (see Remark 3)
B	Isotropic hardening parameter, b (see Remark 3)
ECV	Isotropic hardening parameter, η_{cv} (see Remark 3)
G0	Isotropic hardening parameter, g_0 (see Remark 3)
S0	Isotropic hardening parameter, s_0 (see Remark 3)

Remarks:

1. **Kinematic Hardening.** Kinematic hardening gives rise to the second hardening occurrence in the hardening-softening-hardening sequence. The constants μ_R and λ_L enter the back stress, μB (where B is the left Cauchy-Green deformation tensor), through the function μ according to:

$$\mu = \mu_R \left(\frac{\lambda_L}{3\lambda^p} \right) L^{-1} \left(\frac{\lambda^p}{\lambda_L} \right), \quad (256.1)$$

where $\lambda^p = \frac{1}{\sqrt{3}} \sqrt{\text{tr}(B^p)}$ and B^p is the plastic part of the left Cauchy-Green deformation tensor and L is the Langevin function defined by:

$$L(X) = \coth(X) - X^{-1}.$$

2. **Creep.** This material model assumes plastic incompressibility. Nevertheless in order to account for the different behaviours in tension and compression a Drucker-Prager law is included in the creep law according to:

$$\nu^p = \nu_0 \left(\frac{\bar{\tau}}{s + \alpha\pi} \right)^{1/m}, \quad (256.2)$$

where ν^p is the equivalent plastic shear strain rate, $\bar{\tau}$ is the equivalent shear stress, s is the internal variable defined below and $-\pi$ is the hydrostatic stress.

3. **Isotropic Hardening.** Isotropic hardening gives rise to the first hardening occurrence in the hardening-softening-hardening sequence. Two coupled internal variables are defined: the resistance to plastic flow, s , and the local free volume, η . Their evolution equations are:

$$\dot{s} = h_0 \left[1 - \frac{s}{\bar{s}(\eta)} \right] \nu^p \quad (256.3)$$

$$\dot{\eta} = g_0 \left(\frac{s}{s_{cv}} - 1 \right) v^p \quad (256.4)$$

$$\tilde{s}(\eta) = s_{cv} [1 + b(\eta_{cv} - \eta)] \quad (256.5)$$

4. **Typical Material Parameters.** Typical material parameters values are given in [1] for Polycarbonate:

Variable	Value
K	2.24 GPa
G	0.857 GPA
MR	11.0 MPa
LL	1.45
NUO	0.0017 s ⁻¹
M	0.011
ALPHA	0.08
H0	2.75 GPa
SCV	24.0 MPa
B	825
ECV	0.001
G0	0.006
S0	20.0 MPa

References:

- [1] Anand, L., Gurtin, M.E., 2003, "A theory of amorphous solids undergoing large deformations, with application to polymeric glasses," *International Journal of Solids and Structures*, 40, pp. 1465-1487.
- [2] Bonnaud, E.L., Faleskog, J., 2019, "Explicit, fully implicit and forward gradient numerical integration of a hyperelasto-viscoplastic constitutive model for amorphous polymers undergoing finite deformation," *Computational Mechanics*, 64, pp.1389–1401.

***MAT_NON_QUADRATIC_FAILURE**

This is Material Type 258. This is an elastic-(visco)plastic material with a non-quadratic yield surface where isotropic work hardening is included. A ductile failure model is included in the form of a damage indicator model. The extended Cockcroft-Latham criterion is used to represent the dependence of the failure strain on stress state; see Gruben et. al. [2012]. Mesh dependency of the failure strain is damped out using a regularization scheme based on the deformation mode of the shell element. A more detailed description of this model can be found in the paper by Costas et al. [2018]. The material is available for shell elements only.

Card 1	1	2	3	4	5	6	7	8
Variable	MID	RO	E	PR	SIGY	A	KSI	
Type	A	F	F	F	F	F	F	
Default	none	none	none	none	none	none	none	

Card 2	1	2	3	4	5	6	7	8
Variable	THETA1	Q1	THETA2	Q2	THETA3	Q3		
Type	F	F	F	F	F	F		
Default	none	none	none	none	none	none		

Card 3	1	2	3	4	5	6	7	8
Variable	CS	PDOTS						
Type	F	F						
Default	none	none						

Card 4	1	2	3	4	5	6	7	8
Variable	DCRIT	WCB	WCL	WCS	CC	PHI	GAMMA	THICK
Type	F	F	F	F	F	F	F	F
Default	none	none	none	none	none	none	none	none

VARIABLE**DESCRIPTION**

MID	Material identification. A unique number or label must be specified (see *PART).
RO	Mass density
E	Young's modulus
PR	Poisson's ratio
SIGY	Initial yield stress
A	Exponent of Hershey yield criterion
KSI	Coefficient governing critical strain increment for substepping
THETA _{<i>i</i>}	Initial hardening modulus of R_i
Q_i	Saturation value of R_i
CS	Rate sensitivity of flow stress
PDOTS	Reference strain rate
DCRIT	Critical damage
WCB	Constant defining the damage evolution
WCL	Constant defining the damage evolution
WCS	Constant defining the damage evolution
CC	Constant defining the damage evolution
PHI	Constant defining the damage evolution

GAMMA	Constant defining the damage evolution
THICK	Element thickness if using shell formulation 16

Remarks:

The yield function is defined on the form

$$f = \varphi(\sigma) - (\sigma_0 + R)$$

where $\sigma_{eq} \equiv \varphi(\sigma)$ is the equivalent stress, σ_0 is the initial yield stress, and R is the isotropic hardening variable, which is a function of the equivalent plastic strain p . The equivalent stress is defined as

$$\varphi(\sigma) = \left[\frac{1}{2} \{ |\sigma_1 - \sigma_2|^a + |\sigma_2 - \sigma_3|^a + |\sigma_3 - \sigma_1|^a \} \right]^{\frac{1}{a}}$$

where $\sigma_1 \geq \sigma_2 \geq \sigma_3$ are the ordered principal stresses. The isotropic hardening variable is expressed as

$$R(p) = \sum_{i=1}^3 R_i(p) = \sum_{i=1}^3 Q_i \left(1 - \exp\left(-\frac{\theta_i}{Q_i} p\right) \right)$$

where Q_i and θ_i are in turn the saturation value and initial hardening modulus of the hardening variable R_i . As $p \rightarrow \infty$, R attains its saturation value R_{sat} , given by

$$R_{sat} = \sum_{i=1}^3 Q_i .$$

Note that you can provide nonzero initial values of plastic strain with *INITIAL_STRESS_SHELL which initializes the simulation with nonzero $R_i(p)$ at $t = 0$.

Rate-dependent plasticity is described by a fully viscoplastic formulation. If rate dependence is invoked, the equivalent stress σ_{eq} is constrained by the viscoplastic relation

$$\sigma_{eq} = (\sigma_0 + R(p)) \left(1 + \frac{\dot{p}}{\dot{p}_\sigma} \right)^{C_\sigma} \quad \text{for } f > 0$$

in the plastic domain. The parameters C_σ and \dot{p}_σ govern the rate dependence of the material, where \dot{p}_σ is a reference strain rate.

The uncoupled version of the Extended Cockcroft-Latham (ECL) criterion is applied here to define damage evolution

$$\dot{D} = \frac{\varphi(\sigma)}{W_c} \left\langle \phi \frac{\sigma_1}{\varphi(\sigma)} + (1 - \phi) \frac{\sigma_1 - \sigma_3}{\varphi(\sigma)} \right\rangle^\gamma \dot{p}$$

where D is the damage variable and W_c , ϕ , and γ are parameters governing the damage evolution and its dependence of the stress triaxiality and the Lode parameter. By setting $\phi = \gamma = 1$, we get the Cockcroft-Latham criterion:

$$\dot{D} = \frac{\langle \sigma_1 \rangle}{W_c} \dot{p}$$

where W_c is the Cockcroft-Latham (CL) fracture parameter.

In simulations with shell elements, the CL fracture parameter W_c is defined by

$$W_c = \Omega W_c^b + (1 - \Omega) W_c^m$$

where W_c^b is the CL parameter in pure bending, W_c^m is a mesh-dependent CL parameter in membrane loading, and Ω is a bending indicator given as

$$\Omega = \frac{1}{2} \frac{|\dot{\epsilon}_{3p}^+ - \dot{\epsilon}_{3p}^-|}{\max(|\dot{\epsilon}_{3p}^+|, |\dot{\epsilon}_{3p}^-|)}$$

where $\dot{\epsilon}_{3p}^+$ and $\dot{\epsilon}_{3p}^-$ are the plastic thickness strain rates on the two sides of the shell element. Thus, the bending indicator is $\Omega = 1$ for pure bending ($\dot{\epsilon}_{3p}^- = -\dot{\epsilon}_{3p}^+$) and $\Omega = 0$ ($\dot{\epsilon}_{3p}^- = \dot{\epsilon}_{3p}^+$) for pure membrane loading. The mesh-dependent CL parameter for membrane loading is defined by

$$W_c^m = W_c^l + (W_c^s - W_c^l) \exp\left(-c \left(\frac{l_e}{t_e} - 1\right)\right)$$

where W_c^l , W_c^s , and c are parameters, l_e is the characteristic size of the shell element, and t_e is the thickness of the shell element.

*MAT_STOUGHTON_NON_ASSOCIATED_FLOW_{OPTION}

This is Material Type 260A. This material model is implemented based on non-associated flow rule models (Stoughton 2002 and 2004). Strain rate sensitivity can be included using a load curve. This model applies to both shell and solid elements. It is available for explicit in both MPP and SMP.

Available options include:

<BLANK>

XUE

The option XUE is available for solid elements only.

Card Summary:

Card 1. This card is required.

MID	RO	E	PR	R00	R45	R90	SIG00
-----	----	---	----	-----	-----	-----	-------

Card 2. This card is required.

SIG45	SIG90	SIG_B	LCIDS	LCIDV	SCALE		
-------	-------	-------	-------	-------	-------	--	--

Card 3. This card is included for the XUE keyword option.

EF0	PLIM	Q	GAMA	M	BETA		
-----	------	---	------	---	------	--	--

Card 4. This card is required.

AOPT							
------	--	--	--	--	--	--	--

Card 5. This card is required.

XP	YP	ZP	A1	A2	A3		
----	----	----	----	----	----	--	--

Card 6. This card is required.

V1	V2	V3	D1	D2	D3		
----	----	----	----	----	----	--	--

Data Card Definitions:

Card 1	1	2	3	4	5	6	7	8
Variable	MID	RO	E	PR	R00	R45	R90	SIG00
Type	A	F	F	F	F	F	F	F
Default	none	none	none	none	1.0	R00	R00	Rem 1

VARIABLE**DESCRIPTION**

MID	Material identification. A unique number or label must be specified (see *PART).
RO	Mass density
E	Young's Modulus
PR	Poisson's ratio
R00, R45, R90	Lankford parameters in rolling (0°), diagonal (45°) and transverse (90°) directions, respectively; determined from experiments. Note if R00, R45, and R90 are not defined or are set to 0.0, then R00 = R45 = R90 = 1.0, which degenerates to the Von-Mises yield.
SIG00	Initial yield stress from uniaxial tension tests in rolling (0°) direction

Card 2	1	2	3	4	5	6	7	8
Variable	SIG45	SIG90	SIG_B	LCIDS	LCIDV	SCALE		
Type	F	F	F	I	I	F		
Default	Rem 1	Rem 1	Rem 1	none	none	1.0		

VARIABLE**DESCRIPTION**

SIG45	Initial yield stress from uniaxial tension tests in diagonal (45°) direction
-------	--

VARIABLE	DESCRIPTION
SIG90	Initial yield stress from uniaxial tension tests in transverse (90°) directions
SIG_B	Initial yield stress from equi-biaxial stretching tests
LCIDS	ID of load curve giving stress as a function of strain hardening behavior from a uniaxial tension test along the rolling direction
LCIDV	ID of a load curve defining stress scale factors as a function strain rates, determined from experiments. An example of the curve can be found in Figure M260A-2 . To know which values are used, the strain rates and strain rate scale factors are stored in the d3plot file as history variables #5 and #6, respectively.
SCALE	Parameter for speeding up the simulation while equalizing the strain rate effect. It is useful in cases where the pulling speed or punch speed is slow. See Remark 2 .

XUE Card. This card is included for the XUE keyword option.

Card 3	1	2	3	4	5	6	7	8
Variable	EF0	PLIM	Q	GAMA	M	BETA		
Type	F	F	F	F	F	F		
Default	none	none	none	none	none	0.0		

VARIABLE	DESCRIPTION
EF0, PLIM, Q, GAMA, M, BETA	Material parameters for the option XUE. The parameter k in the original paper is assumed to be 1.0. Note the default BETA value of 0.0 means no progressive weakening damage. For details, refer to Xue, L., Wierzbicki, T.'s 2009 paper "Numerical simulation of fracture mode transition in ductile plates" in the <i>International Journal of Solids and Structures</i> . See Remark 3 .

Card 4	1	2	3	4	5	6	7	8
Variable	AOPT							
Type	I							
Default	none							

VARIABLE**DESCRIPTION**

AOPT

Material axes option (see *MAT_OPTIONTROPIC_ELASTIC*, particularly the [Material Directions](#) section, for details):

EQ.0.0: Locally orthotropic with material axes determined by element nodes 1, 2, and 4, as with **DEFINE_COORDINATE_NODES*. For shells only, the material axes are then rotated about the normal vector to the surface of the shell by the angle BETA.

EQ.1.0: Locally orthotropic with material axes determined by a point, P , in space and the global location of the element center; this is the \mathbf{a} -direction. This option is for solid elements only.

EQ.2.0: Globally orthotropic with material axes determined by vectors defined below, as with **DEFINE_COORDINATE_VECTOR*

EQ.3.0: Locally orthotropic material axes determined by a vector \mathbf{v} and the normal vector to the plane of the element. The plane of a solid element is the midsurface between the inner surface and outer surface defined by the first four nodes and the last four nodes of the connectivity of the element, respectively. Thus, for solid elements, AOPT = 3 is only available for hexahedrons. \mathbf{a} is determined by taking the cross product of \mathbf{v} with the normal vector, \mathbf{b} is determined by taking the cross product of the normal vector with \mathbf{a} , and \mathbf{c} is the normal vector. Then \mathbf{a} and \mathbf{b} are rotated about \mathbf{c} by an angle BETA. BETA may be set in the keyword input for the element.

EQ.4.0: Locally orthotropic in a cylindrical coordinate system with the material axes determined by a vector \mathbf{v} , and an originating point, P , which define the centerline axis. This option is for solid elements only.

VARIABLE**DESCRIPTION**

LT.0.0: The absolute value of AOPT is a coordinate system ID number (CID on *DEFINE_COORDINATE_OPTION).

Card 5	1	2	3	4	5	6	7	8
Variable	XP	YP	ZP	A1	A2	A3		
Type	F	F	F	F	F	F		

VARIABLE**DESCRIPTION**

XP, YP, ZP

Coordinates of point p for AOPT = 1 and 4

A1, A2, A3

Components of vector \mathbf{a} for AOPT = 2

Card 6	1	2	3	4	5	6	7	8
Variable	V1	V2	V3	D1	D2	D3		
Type	F	F	F	F	F	F		

VARIABLE**DESCRIPTION**

V1, V2, V3

Components of vector \mathbf{v} for AOPT = 3 and 4

D1, D2, D3

Components of vector \mathbf{d} for AOPT = 2**The Stoughton Non-Associated Flow Rule:**

In a non-associated flow rule, the material yield function is not equal to the plastic flow potential. According to Thomas B. Stoughton's paper titled "A non-associated flow rule for sheet metal forming" in 2002 International Journal of Plasticity 18, 687-714, and "A pressure-sensitive yield criterion under a non-associated flow rule for sheet metal forming" in 2004 International Journal of Plasticity 20, 705-731, the plastic potential is given by:

$$\bar{\sigma}_p = \sqrt{\sigma_{11}^2 + \lambda_p \sigma_{22}^2 - 2\nu_p \sigma_{11} \sigma_{22} + 2\rho_p \sigma_{12}^2}$$

where σ_{ij} is the stress tensor component. Here,

$$\lambda_p = \frac{1 + \frac{1}{r_{90}}}{1 + \frac{1}{r_0}} ,$$

$$\nu_p = \frac{r_0}{1 + r_0} ,$$

$$\rho_p = \frac{\frac{1}{r_0} + \frac{1}{r_{90}}}{1 + \frac{1}{r_0}} \left(\frac{1}{2} + r_{45} \right) .$$

r_0 , r_{45} , and r_{90} are Lankford parameters in the rolling (0°), the diagonal (45°) and the transverse (90°) directions, respectively.

The yield function is given by:

$$\bar{\sigma}_y = \sqrt{\sigma_{11}^2 + \lambda_y \sigma_{22}^2 - 2\nu_y \sigma_{11} \sigma_{22} + 2\rho_y \sigma_{12}^2} ,$$

where

$$\lambda_y = \left(\frac{\sigma_0}{\sigma_{90}} \right)^2 ,$$

$$\nu_y = \frac{1}{2} \left[1 + \lambda_y - \left(\frac{\sigma_0}{\sigma_b} \right)^2 \right] ,$$

$$\rho_y = \frac{1}{2} \left[\left(\frac{2\sigma_0}{\sigma_{45}} \right)^2 - \left(\frac{\sigma_0}{\sigma_b} \right)^2 \right] .$$

Here σ_0 , σ_{45} , σ_{90} are the initial yield stresses from uniaxial tension tests in the rolling, diagonal, and transverse directions, respectively. σ_b is the initial yield stress from an equi-biaxial stretching test.

Remarks:

1. **Defaults for SIG00, SIG45, SIG90, and SIG_B.** If not specified, SIG00, SIG45, SIG90, and SIG_B default to the first stress value in LCIDS. Note that if all four values are not specified, the non-associated flow rule degenerates to the associated flow rule.
2. **SCALE.** The variable SCALE is very useful in speeding up the simulation while equalizing the strain rate effect. For example, if the pulling speed is 15 mm/s but running the simulation at this speed will take a long time, you can increase the pulling speed to 500 mm/s while setting SCALE to 0.03. The latter settings will give the same results with the benefit of greatly reduced computational time (see [Figures M260A-3](#) and [M260A-4](#)). Note that the increased absolute value (within a reasonable range) of mass scaling, $-1.0 \times dt2ms$, frequently used in forming simulation does not affect the strain rates, as shown in the [Figure M260A-5](#). See examples in [Verification](#).

- 3. **XUE Parameters.** The following table lists variable names used in this material model with the corresponding symbols in Xue et al [2009] for the option XUE:

EF0	PLIM	Q	GAMA	M
ϵ_{f0}	P_{lim}	q	γ	m

- 4. **History Variables.** The history variables output to d3plot for this material depend on whether the XUE keyword option is used and whether this material is used with an EOS. When the XUE option is used, damage accumulation is output to d3plot. It is history variable #1 without an EOS and history variable #5 with an EOS. The value ranges from 0.0 to 1.0. When XUE is not used, history variable #5 is strain rates and history variable #6 is strain rate scale factors.

Verification:

Uniaxial tension tests were done on a single shell element as shown in Figure M260A-1. Strain rate effect LCIDV is input as shown in Figure M260A-2. In Figure M260A-3, pulling stress as a function of strain from various test conditions are compared with input stress-strain curve A. In summary, using the parameter SCALE, the element can be pulled much faster (500 mm/s vs. 15 mm/s) but achieve the same stress vs. strain results, the same strain rates (history variable #5), and the same strain rate scale factor (history variable #6 in Figure M260A-4). Simulation speed can be improved further with increased mass scaling ($-1.0 \times dt2ms$) without affecting the results; see Figure M260A-5.

A partial keyword input is provided below, for the case with pulling speed of 500 mm/s, strain hardening curve ID of 100, LCIDV curve ID of 105, and strain rate scale factor of 0.03.

```
*KEYWORD
*parameter_expression
R_endtime      0.012
R_v            500.0
*CONTROL_TERMINATION
$  ENDTIM      ENDCYC      DTMIN      ENDNEG      ENDMAS
&endtime
*MAT_STOUGHTON_NON_ASSOCIATED_FLOW
$#  mid      Ro      E      PR      R00      R45      R90      SIG00
    1  7.8000E-9  2.10E05  0.300000  1.1      1.2      1.3      311.0
$  SIG45      SIG90      SIG_B      LCIDS      LCIDV      SCALE
    305.4     321.1     290.3     100      105      0.03
$  AOPT
    3
$  XP      YP      ZP      A1      A2      A3
$  V1      V2      V3      D1      D2      D3      BETA
    1.0
*DEFINE_CURVE
  100
    0.0000E+00      0.30130E+03
    0.1000E-01      0.42295E+03
    0.2000E-01      0.47991E+03
```

*MAT_260A

*MAT_STOUGHTON_NON_ASSOCIATED_FLOW

0.30000E-01	0.52022E+03
0.40000E-01	0.55126E+03
0.50000E-01	0.57615E+03

⋮

*DEFINE_CURVE

105

0.00000E+00	0.10000E+01
0.10000E+00	0.10608E+01
0.50000E+00	0.10828E+01
0.10000E+01	0.10923E+01

⋮

*END

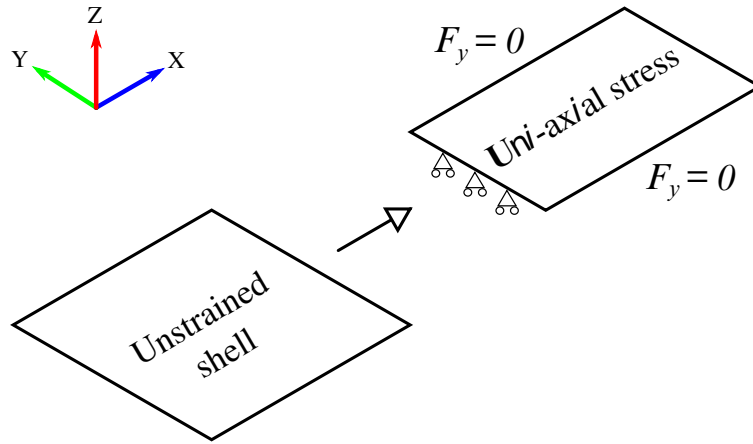

Figure M260A-1. Uniaxial tension tests on a single shell element.

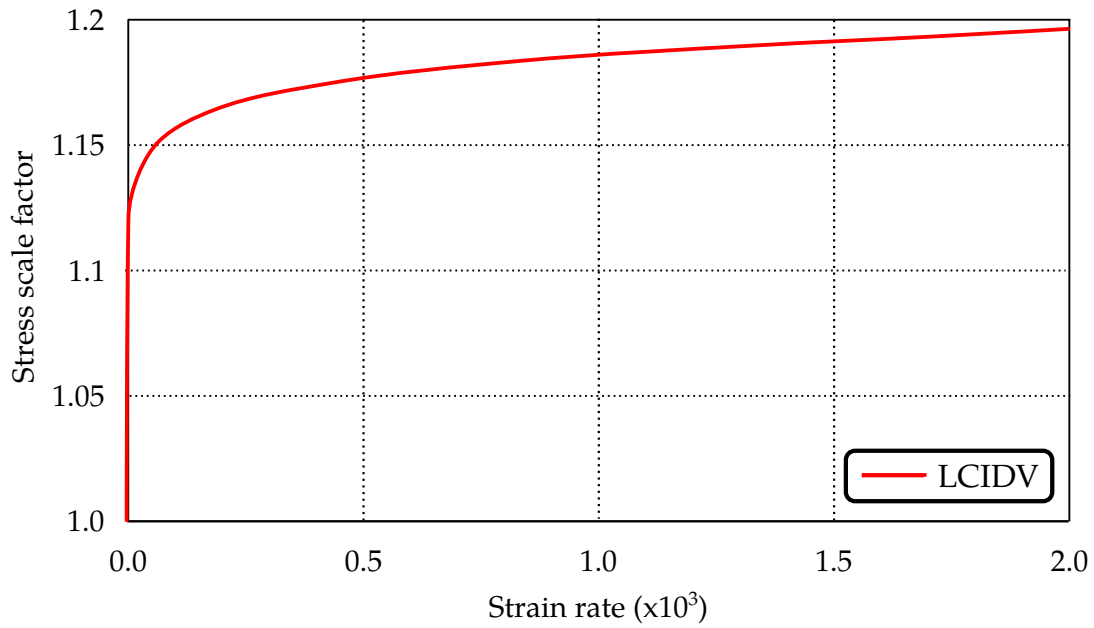

Figure M260A-2. Input LCIDV

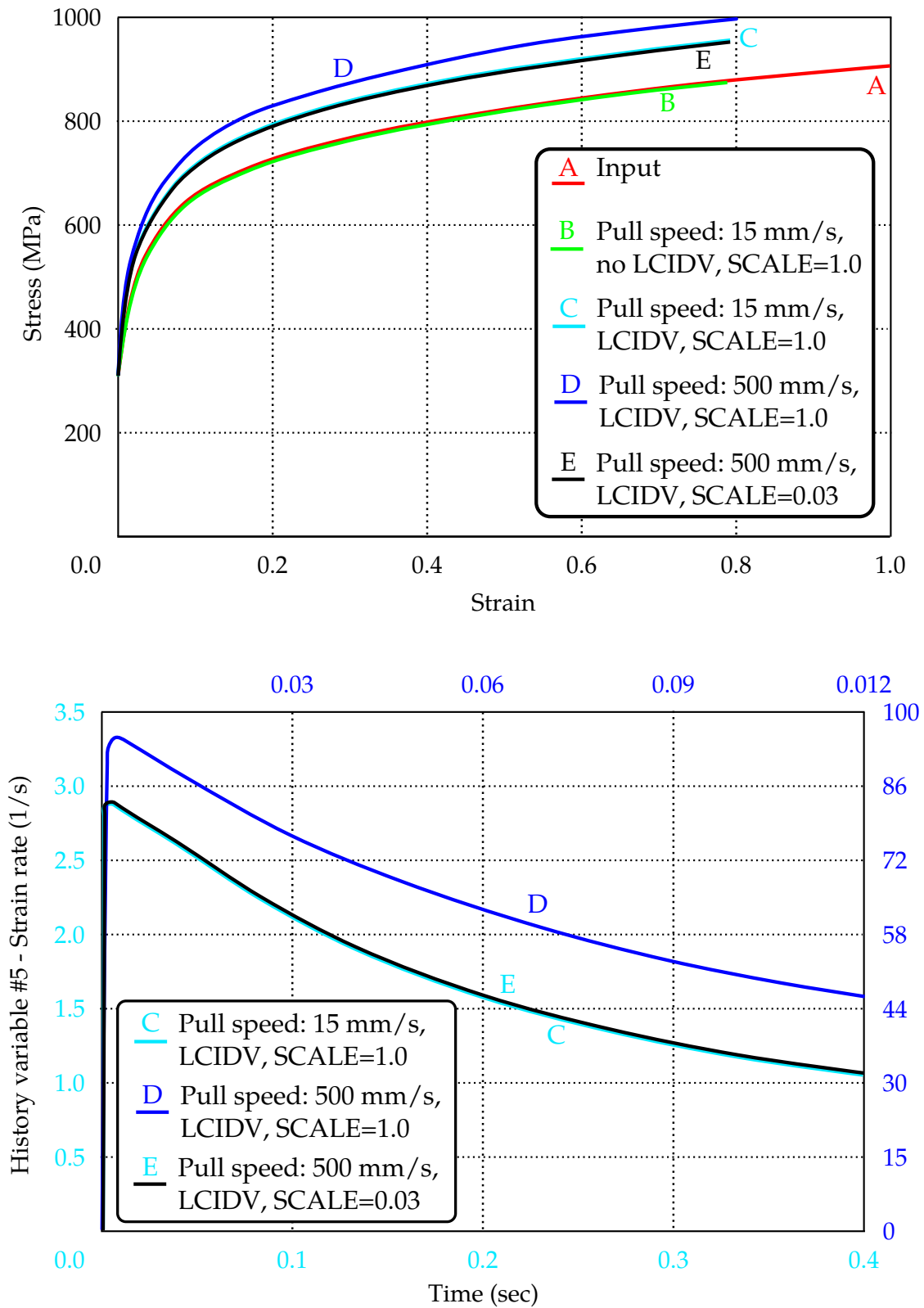

Figure M260A-3. Recovered stress-strain curve (top) and strain rates (bottom) under various conditions shown.

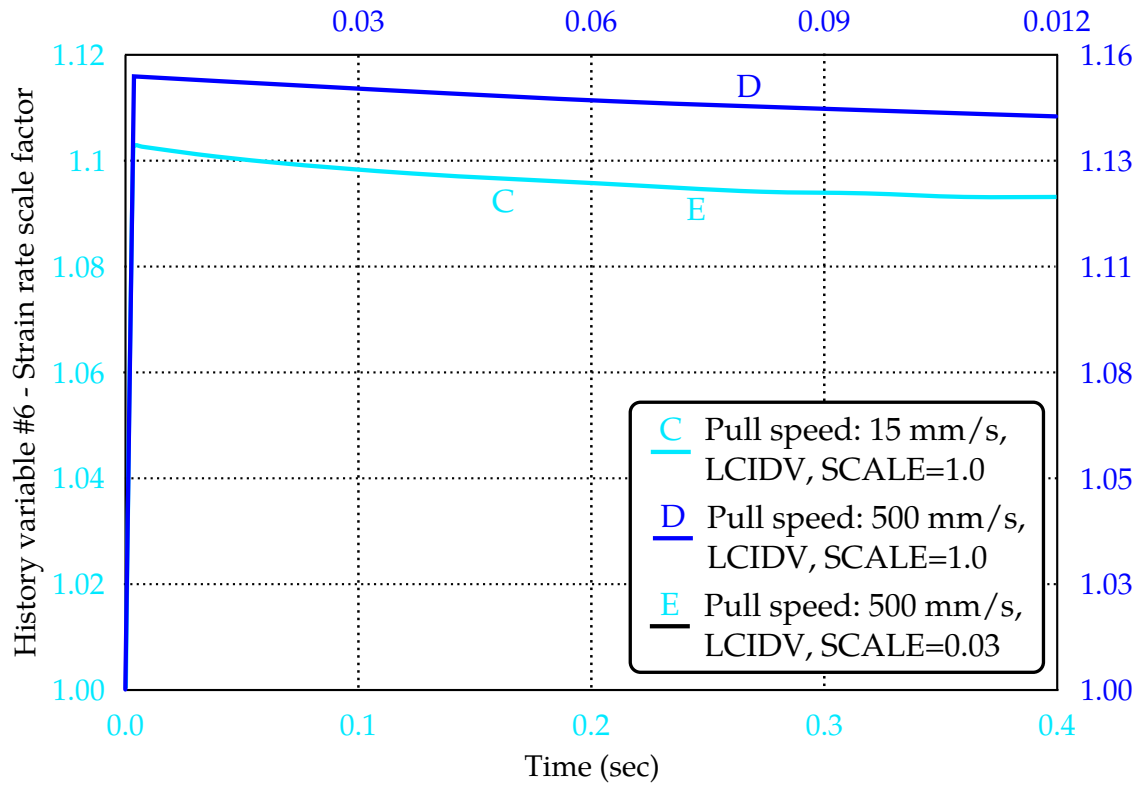

Figure M260A-4. Recovered strain rate scale factors under various conditions shown.

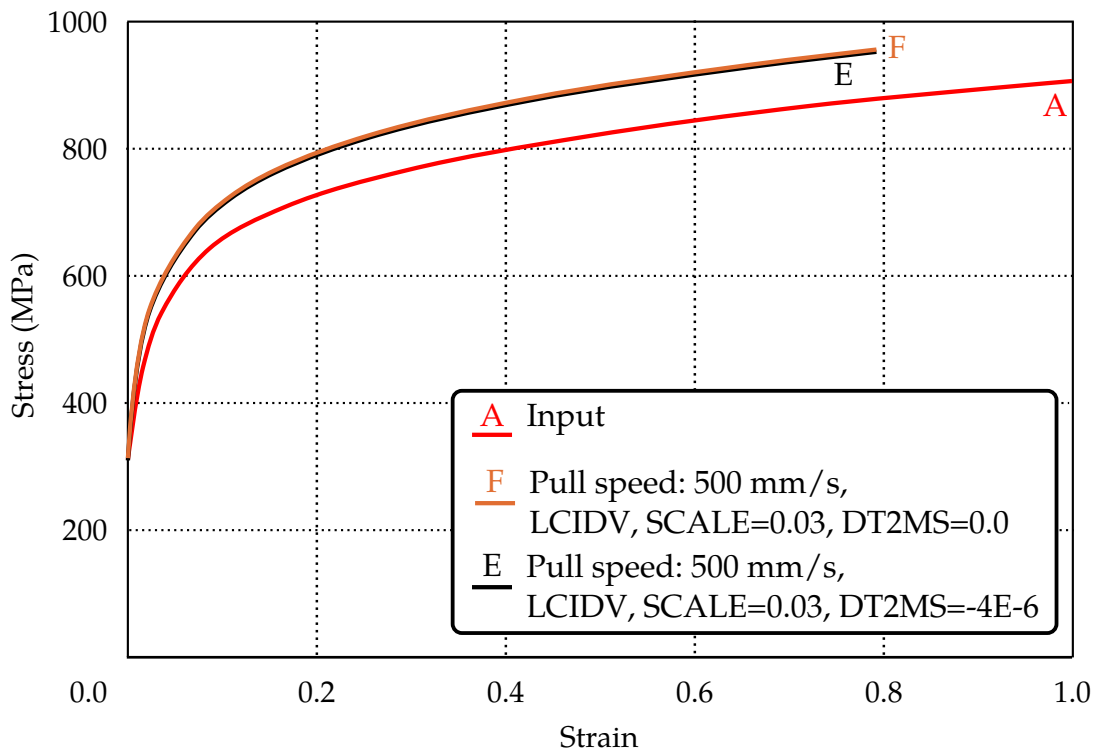

Figure M260A-5. Effect of mass scaling (-1.0*dt2ms).

***MAT_MOHR_NON_ASSOCIATED_FLOW_{OPTION}**

This is Material Type 260B. This material model is implemented based on the papers by Mohr, D., et al. (2010) and Roth, C.C. and Mohr, D. (2014) [1, 2]. The Johnson-Cook plasticity model which includes strain hardening, strain rate hardening, and temperature softening is modified with a mixed Swift-Voce strain hardening function coupled with a non-associated flow rule. For certain Advanced High Strength Steels (AHSS), the non-associated flow rule accounts for the difference between directional dependency of the r -values (planar anisotropic) and the planar isotropic material response. A ductile fracture model is included based on Hosford-Coulomb fracture initiation model. This model applies to shell elements only.

Available options include:

<BLANK>

XUE

Card Summary:

Card 1. This card is required.

MID	RO	E	PR	P12	P22	P33	G12
-----	----	---	----	-----	-----	-----	-----

Card 2. This card is required.

G22	G33	LCIDS	LCIDV	LCIDT	LFLD	LFRAC	W0
-----	-----	-------	-------	-------	------	-------	----

Card 3. This card is required.

A	B0	GAMMA	C	N	SCALE	SIZE0	
---	----	-------	---	---	-------	-------	--

Card 4. This card is required.

TREF	TMELT	M	ETA	CP	TINI	DEPSO	DEPSAD
------	-------	---	-----	----	------	-------	--------

Card 5. This card is included if the XUE keyword option is used.

EFO	PLIM	Q	GAMA	M			
-----	------	---	------	---	--	--	--

Card 6. This card is required.

AOPT							
------	--	--	--	--	--	--	--

Card 7. This card is required.

			A1	A2	A3		
--	--	--	----	----	----	--	--

Card 8. This card is required.

V1	V2	V3						
----	----	----	--	--	--	--	--	--

Data Card Definitions:

Card 1	1	2	3	4	5	6	7	8
Variable	MID	RO	E	PR	P12	P22	P33	G12
Type	A	F	F	F	F	F	F	F
Default	none	none	none	none	-0.5	1.0	3.0	-0.5

VARIABLE

DESCRIPTION

MID	Material identification. A unique number or label must be specified (see *PART).
RO	Mass density
E	Young’s Modulus
PR	Poisson’s ratio
P12, P22, P33	Yield function parameters, defined by Lankford parameters in rolling (0°), diagonal (45°) and transverse (90°) directions, respectively; see Remark 1 .
G12	Plastic flow potential parameters, defined by Lankford parameters in rolling (0°), diagonal (45°) and transverse (90°) directions; see Remark 1 .

Card 2	1	2	3	4	5	6	7	8
Variable	G22	G33	LCIDS	LCIDV	LCIDT	LFLD	LFRAC	W0
Type	F	F	I	I	I	I	I	F
Default	1.0	3.0	none	none	none	0	none	none

VARIABLE	DESCRIPTION
G22, G33	Plastic flow potential parameters, defined by Lankford parameters in rolling (0°), diagonal (45°) and transverse (90°) directions; see Remark 1 .
LCIDS	Load curve ID defining stress as a function of strain hardening from a uniaxial tension test; it must be along the rolling direction. Also see Remark 2 .
LCIDV	Load curve ID defining stress scale factors as a function of strain rates (see Figure M260B-1 middle) as determined from experiments. Strain rates are stored in history variable #5. Strain rate scale factors are stored in history variable #6. To output these history variables to d3plot, set NEIPS to at least "6" in *DATABASE_EXTENT_BINARY. Also see Remark 2
LCIDT	Load curve ID defining stress scale factors as a function of temperature in Kelvin (see Figure M260B-1 bottom) as determined from experiments. Temperatures are stored in history variable #4. Temperature scale factors are stored in history variable #7. To output these history variables to d3plot, set NEIPS to at least "7" in *DATABASE_EXTENT_BINARY. Also see Remark 2 .
LFLD	Load curve ID defining a traditional Forming Limit Diagram for linear strain paths
LFRAC	Load curve ID defining a fracture limit curve. Leave this field empty if fields A, B0, GAMMA, C, and N are defined. However, if this field is defined, fields A, B0, GAMMA, C, and N will be ignored even if they are defined.
W0	Neck (FLD failure) width which typically is the blank thickness

Card 3	1	2	3	4	5	6	7	8
Variable	A	B0	GAMMA	C	N	SCALE	SIZE0	
Type	F	F	F	F	F	F	F	
Default	none	none	none	none	none	1.0	none	

VARIABLE	DESCRIPTION
A, B0, GAM- MA, C, N	Material parameters (a , b_0 , γ , c , n) for the rate-dependent Hosford-Coulomb fracture initiation model; see Remark 3 . Ignored if LFRAC is defined.
SCALE	This field can be used to speed up the simulation while equalizing the strain rate effect, which is useful especially in cases where the pulling speed or punch speed is slow. For example, if the pulling speed is 15 mm/s but running the simulation at this speed will take a long time, the pulling speed can be increased to 500 mm/s while "SCALE" can be set to 0.03, giving the same results as those from 15 mm/s with greatly reduced computational time; see examples and Figures in *MAT_260A for details. Furthermore, the increased absolute value (within a reasonable range) of mass scaling - $1.0 \times dt2ms$ frequently used in forming simulation does not affect the strain rates, as shown in the examples and Figures in *MAT_260A.
SIZE0	Fracture gauge length used in an experimental measurement, typically between 0.2~0.5 mm

Card 4	1	2	3	4	5	6	7	8
Variable	TREF	TMELT	M	ETA	CP	TINI	DEPSO	DEPSAD
Type	F	F	F	F	F	F	F	F
Default	none	none	none	none	none	none	none	none

VARIABLE	DESCRIPTION
TREF	Material parameters for strain softening effect due to temperature. TINI is the initial temperature. See Remark 2 for other parameters' definitions.
TMELT	Reference temperature for modified Johnson-Cook Plasticity Model; see Remark 2 .
M	Exponent coefficient, m , for modified Johnson-Cook Plasticity Model; see Remark 2 .
ETA	Taylor-Quinney coefficient, η_k ; see Remark 2 .

VARIABLE	DESCRIPTION
CP	Heat capacity, C_p ; see Remark 2 .
TINI	Initial temperature; see Remark 2 .
DEPS0	$\dot{\epsilon}_{it}/\dot{\epsilon}_0$; see Remark 2 .
DEPSAD	$\dot{\epsilon}_0$; see Remark 2 .

XUE Card. This card is included if the XUE keyword option is used.

Card 5	1	2	3	4	5	6	7	8
Variable	EF0	PLIM	Q	GAMA	M			
Type	F	F	F	F	F			
Default	none	none	none	none	none			

VARIABLE	DESCRIPTION
EF0, PLIM, Q, GAMA, M	Material parameters for the option XUE. The parameter k in the original paper is assumed to be 1.0. For details, refer to Xue, L. and Wierzbicki, T.'s 2009 paper "Numerical simulation of fracture mode transition in ductile plates" in the <i>International Journal of Solids and Structures</i> [4].

Card 6	1	2	3	4	5	6	7	8
Variable	AOPT							
Type	F							
Default	none							

Card 7	1	2	3	4	5	6	7	8
Variable				A1	A2	A3		
Type				F	F	F		
Default				none	none	none		

Card 8	1	2	3	4	5	6	7	8
Variable	V1	V2	V3					
Type	F	F	F					
Default	none	none	none					

VARIABLE

DESCRIPTION

AOPT

Material axes option (see *MAT_OPTION TROPIC_ELASTIC for a more complete description):

EQ.0.0: locally orthotropic with material axes determined by element nodes 1, 2, and 4, as with *DEFINE_COORDINATE_NODES, and then rotated about the shell element normal by the angle BETA.

EQ.2.0: globally orthotropic with material axes determined by the vector **a** for shells, as with *DEFINE_COORDINATE_VECTOR.

EQ.3.0: locally orthotropic material axes determined by a line in the plane of the element defined by the cross product of the vector **v** with the element normal

LT.0.0: the absolute value of AOPT is a coordinate system ID number (CID on *DEFINE_COORDINATE_NODES, *DEFINE_COORDINATE_SYSTEM or *DEFINE_COORDINATE_VECTOR).

A1, A2, A3

Components of vector **a** for AOPT = 2

V1, V2, V3

Components of vector **v** for AOPT = 3

Remarks:

1. **Non-associated Flow Rule.** Referring to [1] and [2], Hill's 1948 quadratic yield function is written as:

$$f(\sigma, k) = \bar{\sigma} - k = 0 ,$$

where σ is the Cauchy stress tensor and $\bar{\sigma}$ is the equivalent stress, defined by:

$$\bar{\sigma} = \sqrt{(\mathbf{P}\sigma) \bullet \sigma} .$$

\mathbf{P} is a symmetric positive-definite matrix defined through three independent parameters, P_{12} , P_{22} , and P_{33} :

$$\mathbf{P} = \begin{bmatrix} 1 & P_{12} & 0 \\ P_{12} & P_{22} & 0 \\ 0 & 0 & P_{33} \end{bmatrix} .$$

The flow rule, which defines the incremental plastic strain tensor, is written as follows:

$$d\varepsilon_p = d\delta \frac{\partial g(\sigma)}{\partial \sigma} ,$$

where $d\delta$ is a scalar plastic multiplier. The plastic potential function $g(\sigma)$ can be defined as a quadratic function in stress space:

$$g(\sigma) = \sqrt{(\mathbf{G}\sigma) \bullet \sigma}$$

with,

$$\mathbf{G} = \begin{bmatrix} 1 & G_{12} & 0 \\ G_{12} & G_{22} & 0 \\ 0 & 0 & G_{33} \end{bmatrix} .$$

When $\mathbf{P} \neq \mathbf{G}$, the flow rule is non-associated. The associated flow rule is recovered if $\mathbf{P} = \mathbf{G}$. For example, \mathbf{P} can represent an isotropic von-Mises yield surface by setting $P_{11} = P_{22} = 1.0$, $P_{12} = -0.5$, and $P_{33} = 3.0$. \mathbf{G} can represent an orthotropic plastic flow potential by setting:

$$\begin{aligned} G_{12} &= -\frac{r_0}{1+r_0} , \\ G_{22} &= \frac{r_0(1+r_{90})}{r_{90}(1+r_0)} , \\ G_{33} &= \frac{(1+2r_{45})(r_0+r_{90})}{r_{90}(1+r_0)} . \end{aligned}$$

Here r_0 , r_{45} , and r_{90} are the Lankford coefficients in the rolling, diagonal and transverse directions, respectively. Experiments have shown on the stress level, some AHSS (Advanced High Strength Steel), e.g., DP590, and TRIP780 show strong directional dependency for the r -values, while nearly the same stress-strain curves have been measured in all directions. The directional dependency of r -values suggests planar anisotropy while the material response for the stress

is planar isotropic, which is the main reason to employ the non-associated flow rule.

2. **A Modified Johnson-Cook Plasticity Model with Mixed Swift-Voce Hardening.** The Johnson-Cook plasticity model (1983) multiplicatively decomposes the deformation resistance into three functions representing the effects of strain hardening, strain rate, and temperature. The Johnson-Cook model is modified to include hardening saturation with a mixed Swift-Voce hardening law (Sung et al, 2010 [3]), which gives a better description of the hardening at large strain levels, thus improving the prediction of the necking and post-necking response of metal sheet:

$$\sigma_y = \left(\alpha(A(\bar{\varepsilon}_{pl} + \varepsilon_0)^n) + (1 - \alpha)(k_0 + Q(1 - e^{-\beta\bar{\varepsilon}_{pl}})) \right) \left(1 + C \ln \left(\frac{\dot{\bar{\varepsilon}}_{pl}}{\dot{\varepsilon}_0} \right) \right) \left(1 - \left(\frac{T - T_r}{T_m - T_r} \right)^m \right)$$

where $\bar{\varepsilon}_{pl}$ and $\dot{\bar{\varepsilon}}_{pl}$ are effective plastic strain and strain rate, respectively; T_m (TMELT), T_r (TREF) and T are the melting temperature, reference temperature (ambient temperature 293 K) and current temperature, respectively; and m (M) is an exponent coefficient. For other symbols' definitions refer to the aforementioned paper.

To make this material model more general and flexible, three load curves are used to define the three components of the deformation resistance. A load curve (LCIDS) is used to describe the strain hardening:

$$\alpha(A(\bar{\varepsilon}_{pl} + \varepsilon_0)^n) + (1 - \alpha)(k_0 + Q(1 - e^{-\beta\bar{\varepsilon}_{pl}}))$$

Strain rate is described by a load curve LCIDV (stress scale factor vs. strain rates, [Figure M260B-1](#) middle), which scales the stresses based on the strain rates during a simulation:

$$1 + C \ln \left(\frac{\dot{\bar{\varepsilon}}_{pl}}{\dot{\varepsilon}_0} \right)$$

The temperature softening effect is defined by another load curve LCIDT (stress scale factor as a function of temperature, [Figure M260B-1](#) bottom), which scales the stresses based on the temperatures during the simulation:

$$1 - \left(\frac{T - T_r}{T_m - T_r} \right)^m$$

The temperature effect is a self-contained model, meaning it does not require thermal exchange with the environment. It calculates temperatures based on plastic strain and strain rate.

The temperature evolution is determined with:

$$dT = \omega[\dot{\bar{\epsilon}}_{pl}] \frac{\eta_k}{\rho C_p} \bar{\sigma} d\bar{\epsilon}_{pl} .$$

where η_k (ETA) is the Taylor-Quinney coefficient; ρ (R0) is the mass density; C_p (CP) is the heat capacity; and

$$\omega[\dot{\bar{\epsilon}}_{pl}] = \begin{cases} 0 & \text{for } \dot{\bar{\epsilon}}_{pl} < \dot{\epsilon}_{it} \\ \frac{(\dot{\bar{\epsilon}}_{pl} - \dot{\epsilon}_{it})^2 (3\dot{\epsilon}_a - 2\dot{\bar{\epsilon}}_{pl} - \dot{\epsilon}_{it})}{(\dot{\epsilon}_a - \dot{\epsilon}_{it})^3} & \text{for } \dot{\epsilon}_{it} \leq \dot{\bar{\epsilon}}_{pl} \leq \dot{\epsilon}_a \\ 1 & \text{for } \dot{\epsilon}_a < \dot{\bar{\epsilon}}_{pl} \end{cases}$$

Here $\dot{\epsilon}_{it} > 0$ and $\dot{\epsilon}_a > \dot{\epsilon}_{it}$ define the limits of the respective domains of isothermal and adiabatic conditions ($\dot{\epsilon}_a = \text{DEPSAD}$). For simplicity, $\dot{\epsilon}_{it} = \dot{\epsilon}_0 \times \text{DEPS0}$.

As shown in a single shell element undergoing uniaxial stretching (see [Figure M260B-1](#)), the general effect of LCIDV is to elevate the strain hardening behavior as the strain rate increases (curve “D” in [Figure M260B-2](#) top), while the effect of LCIDT is strain softening as the temperature rises (curve “C” in [Figure M260B-2](#) top). Initially, due to the combined effect of both LCIDV and LCIDT strain hardening may occur before the temperature rises enough to cause strain softening in the model (curve “E” in [Figure M260B-2](#) top). The temperature and strain rates calculated for each element can be viewed with history variables #4 and #5 (curves “C” and “D” in [Figure M260B-2](#) bottom), respectively, while the strain rate scale factors and temperature scale factors can be viewed with history variable #6 and #7, respectively.

3. **Rate-dependent Hosford-Coulomb Fracture Initiation Model.** An extension of the Hosford-Coulomb fracture initiation model is used to account for the effect of strain rate on ductile fracture. The damage accumulation is calculated through history variable #3. When this history variable reaches 1.0, fracture occurs at an equivalent plastic strain, $\bar{\epsilon}_f$, that is,

$$\int_0^{\epsilon_f} \frac{d\bar{\epsilon}_{pl}}{\bar{\epsilon}_f^{pr}[\eta, \bar{\theta}]} = 1 .$$

Here $\bar{\epsilon}_f^{pr}$, η , and $\bar{\theta}$ are strain to fracture, stress triaxiality, and the Lode parameter, respectively.

The fracture parameters, A, B0, GAMMA, C, and N, are used in the following equations as (a, b_0, γ, c, n) , respectively. Strain to fracture for a proportional load is given as:

$$\bar{\epsilon}_f^{pr}[\eta, \bar{\theta}] = b(1+c)^{\frac{1}{n}} \left(\left\{ \frac{1}{2} \left((f_1 - f_2)^a + (f_2 - f_3)^a + (f_1 - f_3)^a \right) \right\}^{\frac{1}{a}} + c(2\eta + f_1 + f_3) \right)^{-\frac{1}{n}}$$

where a is the Hosford exponent, c is the friction coefficient controlling the effect of triaxiality, and n is the stress state sensitivity. The Lode angle parameter dependent trigonometric functions are given as:

$$f_1[\bar{\theta}] = \frac{2}{3} \cos \left[\frac{\pi}{6} (1 - \bar{\theta}) \right]$$

$$f_2[\bar{\theta}] = \frac{2}{3} \cos \left[\frac{\pi}{6} (3 + \bar{\theta}) \right]$$

$$f_3[\bar{\theta}] = -\frac{2}{3} \cos \left[\frac{\pi}{6} (1 + \bar{\theta}) \right]$$

The coefficient b (strain to fracture for uniaxial or equi-biaxial stretching) is:

$$b = \begin{cases} b_0 & \text{for } \dot{\epsilon}_p < \dot{\epsilon}_0 \\ b_0 \left(1 + \gamma \ln \left[\frac{\dot{\epsilon}_p}{\dot{\epsilon}_0} \right] \right) & \text{for } \dot{\epsilon}_p > \dot{\epsilon}_0 \end{cases}$$

where γ is the strain rate sensitivity.

4. **Corresponding Parameters Summary.** The following table lists variable names used in this material model and corresponding symbols employed in [1], [2], and [3]:

Variable	P12	P22	P33	G12	G22	G33	A	B0
Symbol	P_{12}	P_{22}	P_{33}	G_{12}	G_{22}	G_{33}	a	b_0
Variable	GAMMA	C	N	TREF	TMELT	M	ETA	CP
Symbol	γ	c	N	T_r	T_m	m	η_k	C_p
Variable	DEPS0	DEPSAD	R0					
Symbol	$\dot{\epsilon}_{it}/\dot{\epsilon}_0$	$\dot{\epsilon}_a$	ρ					

The following table lists variable names used in this material model and corresponding symbols in Xue’s 2009 paper [4], for the option XUE:

Variable	EF0	P22	P33	G12	G22			
Symbol	ϵ_{f0}	P_{lim}	q	γ	m			

5. **Additional History Variables.** The table below lists the extra history variables associated with this material. See NEIPS on the manual page for *DATABASE_EXTENT_BINARY.

History Variable #	Description
3	Damage accumulation. Elements will be deleted if this variable reaches 1.0 for more than half of the through-thickness integration points.
4	Temperatures
5	Strain rates
6	Strain rate scale factors
7	Temperature scale factor

Keyword Example Input:

A sample material input card can be found below, with parameters from Mohr, D., et al. (2010) and Roth, C.C. and Mohr, D. (2014).

```

*MAT_MOHR_NON_ASSOCIATED_FLOW
$# mid R0 E PR P12 P22 P33 G12
1 7.8000E-9 2.10E05 0.300000 -0.5 1.0 3.0 -0.4946
$ G22 G33 LCIDS LCIDV LCIDT LFLD LFRAC W0
0.9318 2.4653 100 105 102
$ A B0 GAMMA C N SCALE
1.97 0.82 0.025 0.00 0.199 3.132E-3
$ TREF TMELT M ETA CP TIN1 DEPSO DEPSAD
293.0 1673.70 0.921 0.9 420.0 293.0 0.001164 1.379
$ AOPT
3
$ XP YP ZP A1 A2 A3
$ V1 V2 V3 D1 D2 D3 BETA
1.0
*DEFINE_CURVE
100
0.00000E+00 0.30130E+03

```

```

0.10000E-01      0.42295E+03
0.20000E-01      0.47991E+03
0.30000E-01      0.52022E+03
0.40000E-01      0.55126E+03
:
:
*DEFINE_CURVE
105
0.00000E+00      0.10000E+01
0.10000E+00      0.10608E+01
0.50000E+00      0.10828E+01
0.10000E+01      0.10923E+01
:
:
*DEFINE_CURVE
102
0.29300E+03      0.10000E+01
0.33300E+03      0.96168E+00
0.37300E+03      0.92744E+00
0.41300E+03      0.89459E+00
0.45300E+03      0.86261E+00
:
:

```

References:

- [1] D. Mohr, M. Dunand, K. Kim, "Evaluation of associated and non-associated quadratic plasticity models for advanced high strength steel sheets under multi-axial loading," *International Journal of Plasticity*, Vol 26, Issue 7, <https://doi.org/10.1016/j.ijplas.2009.11.006>, July 2010.
- [2] C.C. Roth and D. Mohr, "Effect of strain rate on ductile fracture initiation in advanced high strength steel sheets: Experiments and modeling," *International Journal of Plasticity*, Vol 56, <https://doi.org/10.1016/j.ijplas.2014.01.003>, May 2014.
- [3] J.H. Sung, J.H. Kim, R.H. Wagoner, "A plastic constitutive equation incorporating strain, strain-rate, and temperature," *International Journal of Plasticity*, Vol 26, Issue 12, <https://doi.org/10.1016/j.ijplas.2010.02.005>, December 2010.
- [4] L. Xue and T. Wierzbicki, "Numerical simulation of fracture mode transition in ductile plates," *International Journal of Solids and Structures*, Vol 46, Issue 6, <https://doi.org/10.1016/j.ijsol-str.2008.11.009>, March 2009.

Revision Information::

This material model is available in SMP starting in Revision 102375. Revision history is listed below:

- Element deletion feature based on damage accumulation: Revision 109792.
- The option XUE is available starting on Revision 111531.
- Set default values for P12, P22, P33, G12, G22 and G33: Revision 116262.

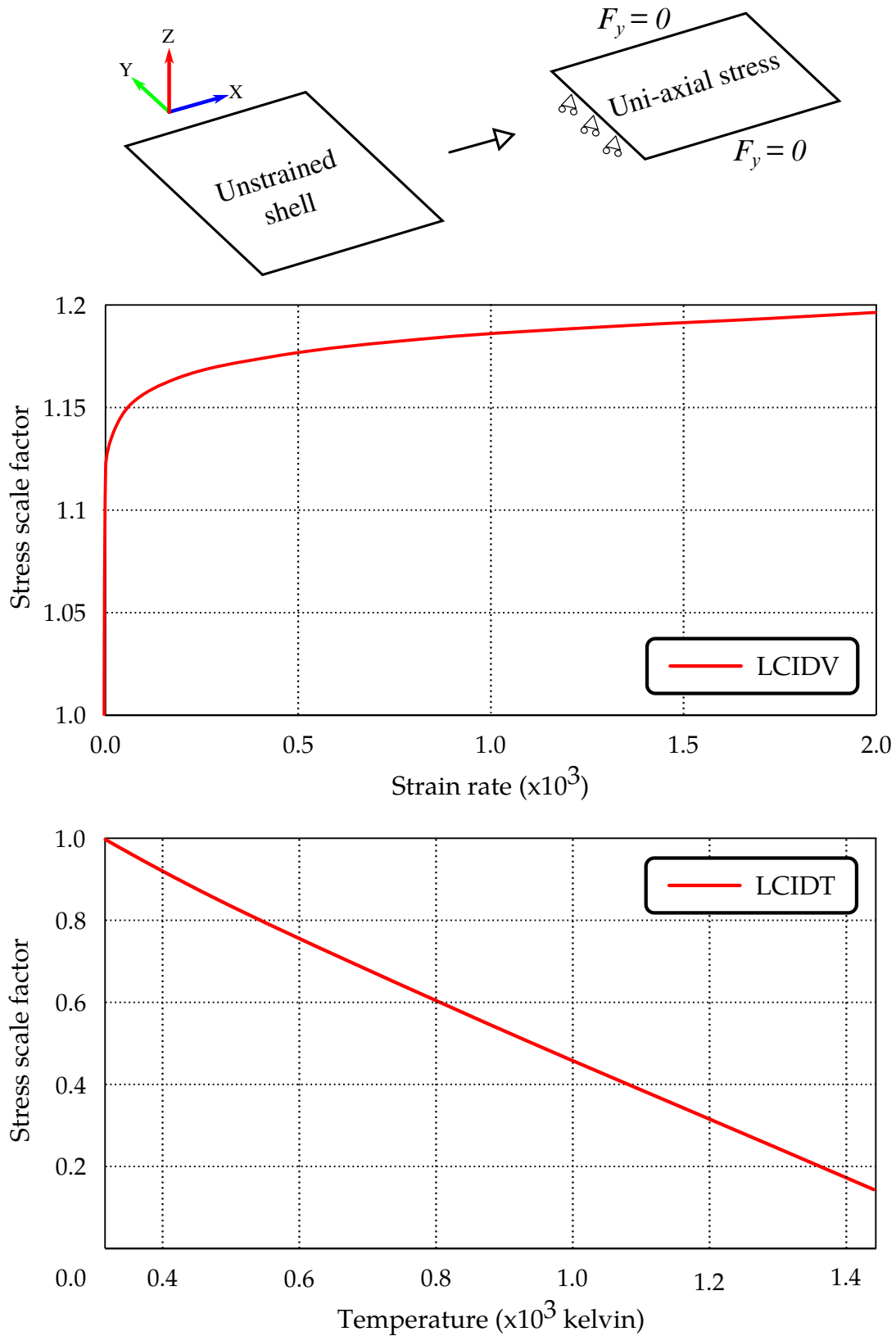

Figure M260B-1. Uniaxial stretching on a single shell element; Input curves LCIDV and LCIDT.

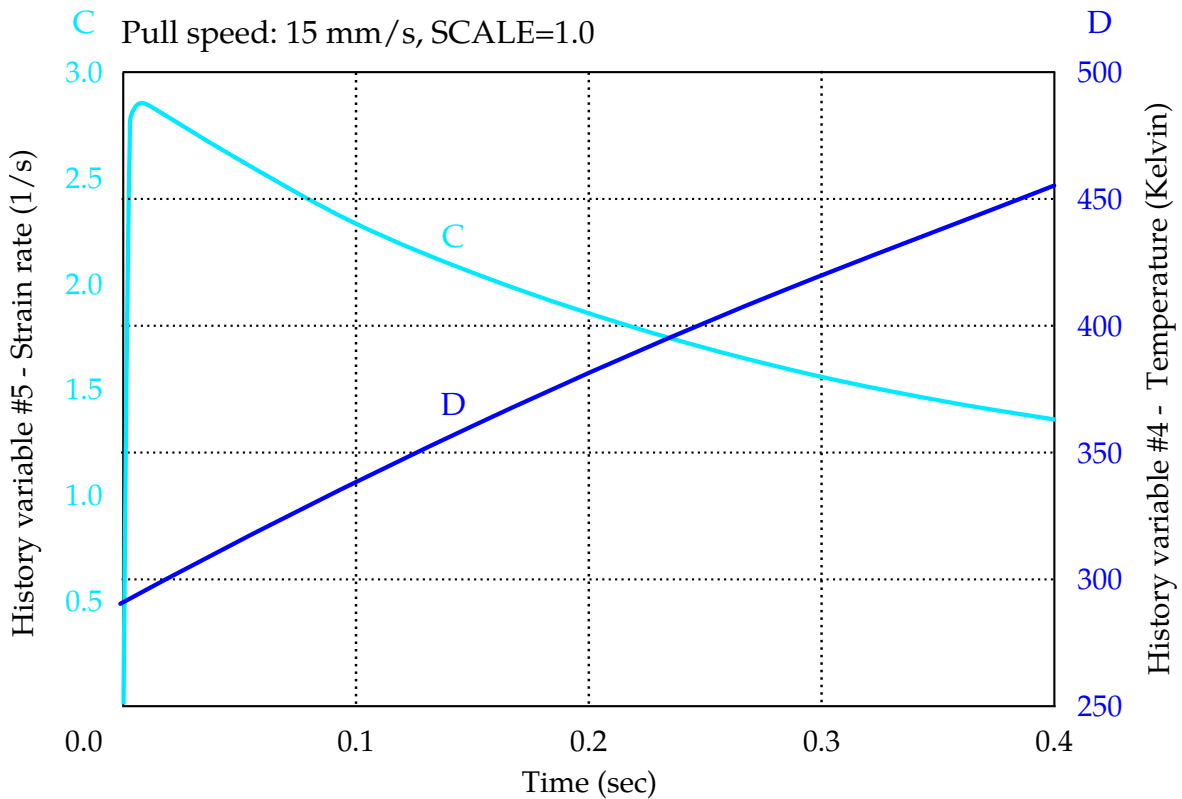
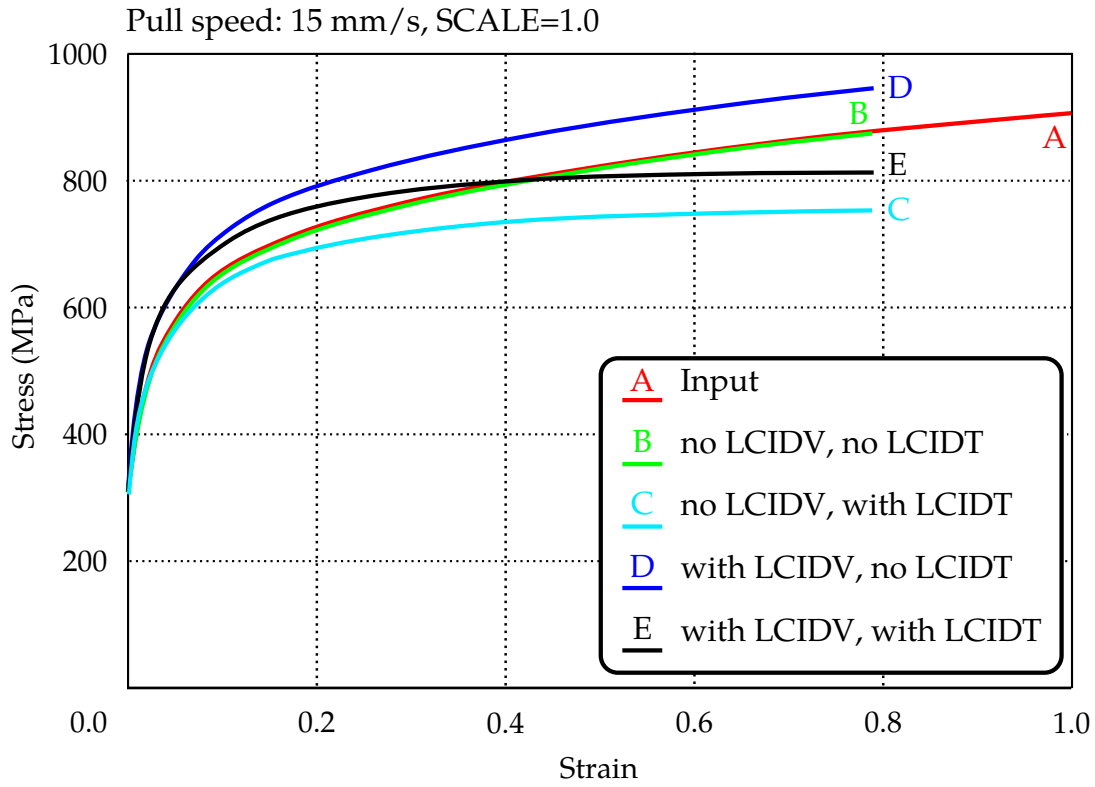

Figure M260B-2. Results of a single element uniaxial stretching - stress-strain curves (top), strain rates and temperature history under various conditions.

***MAT_LAMINATED_FRACTURE_DAIMLER_PINHO**

This is Material Type 261 which is an orthotropic continuum damage model for laminated fiber-reinforced composites. See Pinho, Iannucci and Robinson [2006]. It is based on a physical model for each failure mode and considers non-linear in-plane shear behavior.

This model is implemented for shell, thick shell and solid elements.

Note: Laminated shell theory can be applied by setting $LAMSHT \geq 3$ in *CONTROL_-SHELL.

Card Summary:

Card 1. This card is required.

MID	RO	EA	EB	EC	PRBA	PRCA	PRCB
-----	----	----	----	----	------	------	------

Card 2. This card is required.

GAB	GBC	GCA	AOPT	DAF	DKF	DMF	EFS
-----	-----	-----	------	-----	-----	-----	-----

Card 3. This card is required.

XP	YP	ZP	A1	A2	A3		
----	----	----	----	----	----	--	--

Card 4. This card is required.

V1	V2	V3	D1	D2	D3	MANGLE	
----	----	----	----	----	----	--------	--

Card 5. This card is required.

ENKINK	ENA	ENB	ENT	ENL			
--------	-----	-----	-----	-----	--	--	--

Card 6. This card is required.

XC	XT	YC	YT	SL			
----	----	----	----	----	--	--	--

Card 7. This card is required.

FIO	SIGY	LCSS	BETA	PFL	PUCK	SOFT	DT
-----	------	------	------	-----	------	------	----

Data Card Definitions:

Card 1	1	2	3	4	5	6	7	8
Variable	MID	RO	EA	EB	EC	PRBA	PRCA	PRCB
Type	A	F	F	F	F	F	F	F

VARIABLE**DESCRIPTION**

MID	Material identification. A unique number or label must be specified (see *PART).
RO	Mass density
EA	E_a , Young's modulus in a -direction (longitudinal)
EB	E_b , Young's modulus in b -direction (transverse)
EC	E_c , Young's modulus in c -direction
PRBA	ν_{ba} , Poisson's ratio ba
PRCA	ν_{ca} , Poisson's ratio ca
PRCB	ν_{cb} , Poisson's ratio cb

Card 2	1	2	3	4	5	6	7	8
Variable	GAB	GBC	GCA	AOPT	DAF	DKF	DMF	EFS
Type	F	F	F	F	F	F	F	F

VARIABLE**DESCRIPTION**

GAB	G_{ab} , shear modulus ab
GBC	G_{bc} , shear modulus bc
GCA	G_{ca} , shear modulus ca

VARIABLE	DESCRIPTION
AOPT	<p>Material axes option (see <code>MAT_OPTIONTROPIC_ELASTIC</code>, particularly the Material Directions section, for details):</p> <p>EQ.0.0: Locally orthotropic with material axes determined by element nodes 1, 2, and 4, as with <code>*DEFINE_COORDINATE_NODES</code>. For shells only, the material axes are then rotated about the normal vector to the surface of the shell by an angle (see <code>MANGLE</code> on Card 4).</p> <p>EQ.1.0: Locally orthotropic with material axes determined by a point, P, in space and the global location of the element center; this is the a-direction. This option is for solid elements only.</p> <p>EQ.2.0: Globally orthotropic with material axes determined by vectors defined below, as with <code>*DEFINE_COORDINATE_VECTOR</code></p> <p>EQ.3.0: Locally orthotropic material axes determined by a vector \mathbf{v} and the normal vector to the plane of the element. The plane of a solid element is the midsurface between the inner surface and outer surface defined by the first four nodes and the last four nodes of the connectivity of the element, respectively. Thus, for solid elements, <code>AOPT = 3</code> is only available for hexahedrons. a is determined by taking the cross product of \mathbf{v} with the normal vector, b is determined by taking the cross product of the normal vector with a, and c is the normal vector. Then a and b are rotated about c by an angle. This angle may be set in the keyword input for the element or in the input for this keyword (see <code>MANGLE</code> on Card 4).</p> <p>EQ.4.0: Locally orthotropic in a cylindrical coordinate system with the material axes determined by a vector \mathbf{v}, and an originating point, P, which define the centerline axis. This option is for solid elements only.</p> <p>LT.0.0: The absolute value of <code>AOPT</code> is a coordinate system ID number (<code>CID</code> on <code>*DEFINE_COORDINATE_OPTION</code>).</p>
DAF	<p>Flag to control failure of an integration point based on longitudinal (fiber) tensile failure:</p> <p>EQ.0.0: Integration point fails if any damage variable reaches 1.0.</p>

VARIABLE	DESCRIPTION
----------	-------------

DKF	<p>EQ.1.0: No failure of integration point due to fiber tensile failure. This condition corresponds to history variable “da(i)” reaching 1.0.</p> <p>Flag to control failure of an integration point based on longitudinal (fiber) compressive failure:</p> <p>EQ.0.0: Integration point fails if any damage variable reaches 1.0.</p> <p>EQ.1.0: No failure of integration point due to fiber compressive failure. This condition corresponds to history variable “dkink(i)” reaching 1.0.</p>
DMF	<p>Flag to control failure of an integration point based on transverse (matrix) failure:</p> <p>EQ.0.0: Integration point fails if any damage variable reaches 1.0.</p> <p>EQ.1.0: No failure of integration point due to matrix failure. This condition corresponds to history variable “dmat(i)” reaching 1.0.</p>
EFS	<p>Maximum effective strain for element layer failure. A value of unity would equal 100% strain.</p> <p>GT.0.0: Fails when effective strain calculated assuming material is volume preserving exceeds EFS</p> <p>LT.0.0: Fails when effective strain calculated from the full strain tensor exceeds EFS </p>

Card 3	1	2	3	4	5	6	7	8
Variable	XP	YP	ZP	A1	A2	A3		
Type	F	F	F	F	F	F		

VARIABLE	DESCRIPTION
----------	-------------

XP, YP, ZP	Coordinates of point <i>P</i> for AOPT = 1 and 4
A1, A2, A3	Components of vector a for AOPT = 2

Card 4	1	2	3	4	5	6	7	8
Variable	V1	V2	V3	D1	D2	D3	MANGLE	
Type	F	F	F	F	F	F	F	

VARIABLE**DESCRIPTION**

V1, V2, V3

Components of vector \mathbf{v} for AOPT = 3

D1, D2, D3

Components of vector \mathbf{d} for AOPT = 2

MANGLE

Material angle in degrees for AOPT = 0 (shells and tshells only) and AOPT = 3. MANGLE may be overridden on the element card; see *ELEMENT_SHELL_BETA, *ELEMENT_TSHELL_BETA, and *ELEMENT_SOLID_ORTHO.

Card 5	1	2	3	4	5	6	7	8
Variable	ENKINK	ENA	ENB	ENT	ENL			
Type	F	F	F	F	F			

VARIABLE**DESCRIPTION**

ENKINK

Fracture toughness for longitudinal (fiber) compressive failure mode.

GT.0.0: The given value will be regularized with the characteristic element length.

LT.0.0: Load curve ID = (-ENKINK) which defines the fracture toughness for fiber compressive failure mode as a function of characteristic element length. No further regularization.

Table ID = (-ENKINK) which defines for each strain rate value a load curve that defines the fracture toughness for fiber compressive failure mode as a function of characteristic element length. No further regularization.

VARIABLE	DESCRIPTION
ENA	<p>Fracture toughness for longitudinal (fiber) tensile failure mode.</p> <p>GT.0.0: The given value will be regularized with the characteristic element length.</p> <p>LT.0.0: Load curve ID = (-ENA) which defines the fracture toughness for fiber tensile failure mode as a function of characteristic element length. No further regularization.</p> <p>Table ID = (-ENA) which defines for each strain rate value a load curve that defines the fracture toughness for fiber tensile failure mode as a function of characteristic element length. No further regularization.</p>
ENB	<p>Fracture toughness for intralaminar matrix tensile failure.</p> <p>GT.0.0: The given value will be regularized with the characteristic element length.</p> <p>LT.0.0: Load curve ID = (-ENB) which defines the fracture toughness for intralaminar matrix tensile failure as a function of characteristic element length. No further regularization.</p> <p>Table ID = (-ENB) which defines for each strain rate value a load curve that defines the fracture toughness for intralaminar matrix tensile failure as a function of characteristic element length. No further regularization.</p>
ENT	<p>Fracture toughness for intralaminar matrix transverse shear failure.</p> <p>GT.0.0: The given value will be regularized with the characteristic element length.</p> <p>LT.0.0: Load curve ID = (-ENT) which defines the fracture toughness for intralaminar matrix transverse shear failure as a function of characteristic element length. No further regularization.</p> <p>Table ID = (-ENT) which defines for each strain rate value a load curve that defines the fracture toughness for intralaminar matrix transverse shear failure as a function of characteristic element length. No further regularization.</p>

VARIABLE	DESCRIPTION
-----------------	--------------------

ENL	Fracture toughness for intralaminar matrix longitudinal shear failure.
-----	--

GT.0.0: The given value will be regularized with the characteristic element length.

LT.0.0: Load curve ID = (-ENL) which defines the fracture toughness for intralaminar matrix longitudinal shear failure as a function of characteristic element length. No further regularization.

Table ID = (-ENL) which defines for each strain rate value a load curve that defines the fracture toughness for intralaminar matrix longitudinal shear failure as a function of characteristic element length. No further regularization.

Card 6	1	2	3	4	5	6	7	8
Variable	XC	XT	YC	YT	SL			
Type	F	F	F	F	F			

VARIABLE	DESCRIPTION
-----------------	--------------------

XC	Longitudinal compressive strength, <i>a</i> -axis (positive value).
----	---

GT.0.0: Constant value

LT.0.0: Load curve ID = (-XC) which defines the longitudinal compressive strength as a function of longitudinal strain rate ($\dot{\epsilon}_{aa}$)

XT	Longitudinal tensile strength, <i>a</i> -axis.
----	--

GT.0.0: Constant value

LT.0.0: Load curve ID = (-XT) which defines the longitudinal tensile strength as a function of longitudinal strain rate ($\dot{\epsilon}_{aa}$)

VARIABLE	DESCRIPTION
YC	<p>Transverse compressive strength, b-axis (positive value).</p> <p>GT.0.0: Constant value</p> <p>LT.0.0: Load curve ID = (-YC) which defines the transverse compressive strength as a function of transverse strain rate ($\dot{\epsilon}_{bb}$)</p>
YT	<p>Transverse tensile strength, b-axis.</p> <p>GT.0.0: Constant value</p> <p>LT.0.0: Load curve ID = (-YT) which defines the transverse tensile strength as a function of transverse strain rate ($\dot{\epsilon}_{bb}$)</p>
SL	<p>Longitudinal shear strength.</p> <p>GT.0.0: Constant value</p> <p>LT.0.0: Load curve ID = (-SL) which defines the longitudinal shear strength as a function of in-plane shear strain rate ($\dot{\epsilon}_{ab}$)</p>

Card 7	1	2	3	4	5	6	7	8
Variable	FIO	SIGY	LCSS	BETA	PFL	PUCK	SOFT	DT
Type	F	F	F	F	F	F	F	F

VARIABLE	DESCRIPTION
FIO	Fracture angle in pure transverse compression (default = 53.0°)
SIGY	In-plane shear yield stress (only used when BETA < 1.0)
LCSS	<p>Load curve ID or Table ID.</p> <p>Load Curve. When LCSS is a load curve ID, it defines the non-linear in-plane shear-stress as a function of in-plane shear-strain (γ_{ab}).</p>

VARIABLE	DESCRIPTION
	<p>Tabular Data. The table maps in-plane strain rate values ($\dot{\gamma}_{ab}$) to a load curve giving the in-plane shear-stress as a function of in-plane shear-strain. For strain rates below the minimum value, the curve for the lowest defined value of strain rate is used. Likewise, when the strain rate exceeds the maximum value, the curve for the highest defined value of strain rate is used.</p> <p>Logarithmically Defined Table. An alternative way to invoke logarithmic interpolation between discrete strain rates is described as follows. If the <i>first</i> value in the table is negative, LS-DYNA assumes that all the table values represent the natural logarithm of a strain rate. Since the tables are internally discretized to equally space the table values, it makes good sense from an accuracy standpoint that the table values represent the natural log of strain rate when the lowest strain rate and highest strain rate differ by several orders of magnitude. There is some additional computational cost associated with invoking logarithmic interpolation.</p>
BETA	<p>Hardening parameter for in-plane shear plasticity ($0.0 \leq \text{BETA} \leq 1.0$).</p> <p>EQ.0.0: Pure kinematic hardening</p> <p>EQ.1.0: Pure isotropic hardening</p> <p>$0.0 < \text{BETA} < 1.0$: Mixed hardening</p>
PFL	<p>Percentage of shell or tshell layers which must fail until crashfront is initiated. For example, if $\text{PFL} = 80.0$, then 80% of layers must fail until strengths are reduced in neighboring elements. Default: all layers must fail. A single layer fails if 1 in-plane integration point fails ($\text{PFL} > 0$) or if 4 in-plane integration points fail ($\text{PFL} < 0$).</p>
PUCK	<p>Flag for evaluation and post-processing of Puck's inter-fiber-failure criterion (IFF); see Puck, Kopp and Knops [2002].</p> <p>EQ.0.0: No evaluation of Puck's IFF-criterion.</p> <p>EQ.1.0: Puck's IFF-criterion will be evaluated.</p>
SOFT	<p>Softening reduction factor for material strength in crashfront elements (default = 1.0)</p>
DT	<p>Strain rate averaging option:</p> <p>EQ.0.0: Strain rate is evaluated using a running average.</p>

VARIABLE	DESCRIPTION
	LT.0.0: Strain rate is evaluated using an average of the last 11 time steps.
	GT.0.0: Strain rate is averaged over the last DT time units.

Remarks:

1. **Failure Surfaces.** The failure surface to limit the elastic domain is assembled by *four* sub-surfaces, representing different failure mechanisms. See [Figure M261-1](#) for a definition of angles. They are defined as follows:

- a) longitudinal (fiber) tension,

$$f_a = \frac{\sigma_a}{X_T} = 1$$

- b) longitudinal (fiber) compression (3D-kinking model) – (transformation to fracture plane),

$$f_{kink} = \begin{cases} \left(\frac{\tau_T}{S_T - \mu_T \sigma_n} \right)^2 + \left(\frac{\tau_L}{S_L - \mu_L \sigma_n} \right)^2 = 1 & \text{if } \sigma_{b^m} \leq 0 \\ \left(\frac{\sigma_n}{Y_T} \right)^2 + \left(\frac{\tau_T}{S_T} \right)^2 + \left(\frac{\tau_L}{S_L} \right)^2 = 1 & \text{if } \sigma_{b^m} > 0 \end{cases}$$

with

$$S_T = \frac{Y_C}{2 \tan(\phi_0)}$$

$$\mu_T = -\frac{1}{\tan(2\phi_0)}$$

$$\mu_L = S_L \frac{\mu_T}{S_T}$$

$$\sigma_n = \frac{\sigma_{b^m} + \sigma_{c^\psi}}{2} + \frac{\sigma_{b^m} - \sigma_{c^\psi}}{2} \cos(2\phi) + \tau_{b^m c^\psi} \sin(2\phi)$$

$$\tau_T = -\frac{\sigma_{b^m} - \sigma_{c^\psi}}{2} \sin(2\phi) + \tau_{b^m c^\psi} \cos(2\phi)$$

$$\tau_L = \tau_{a^m b^m} \cos(\phi) + \tau_{c^\psi a^m} \sin(\phi)$$

- c) transverse (matrix) failure: transverse tension,

$$f_{mat} = \left(\frac{\sigma_n}{Y_T} \right)^2 + \left(\frac{\tau_T}{S_T} \right)^2 + \left(\frac{\tau_L}{S_L} \right)^2 = 1 \quad \text{if } \sigma_n \geq 0$$

with

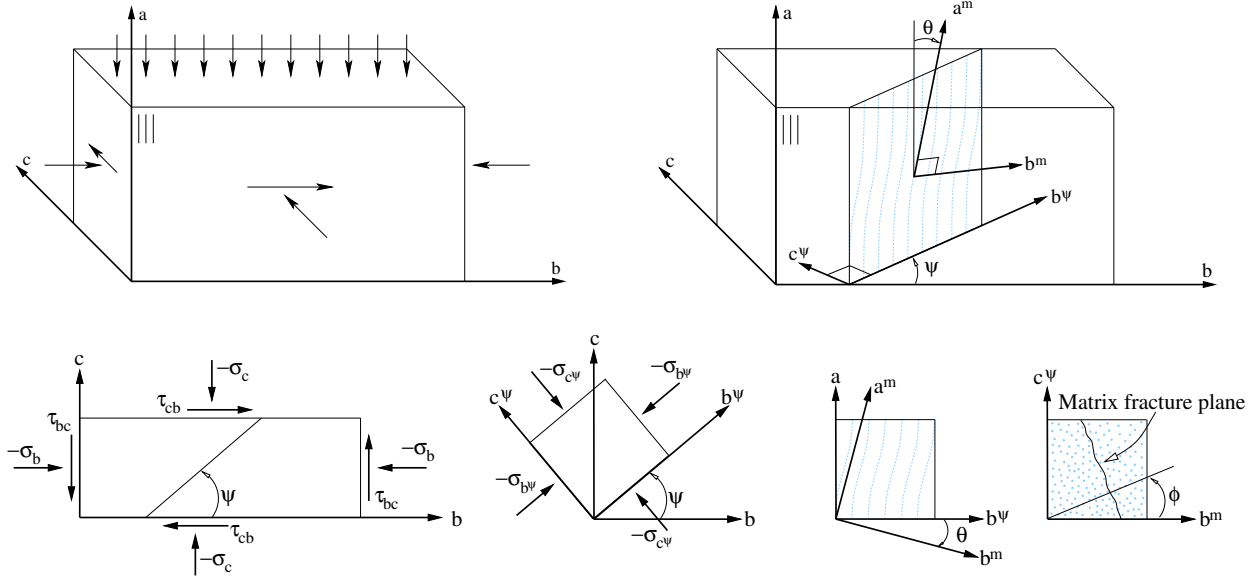

Figure M261-1. Definition of angles and stresses in fracture plane

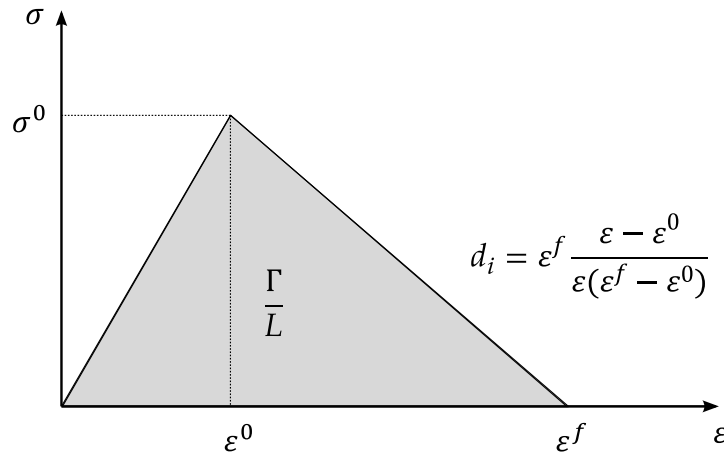

Figure M261-2. Damage evolution law

$$\sigma_n = \frac{\sigma_b + \sigma_c}{2} + \frac{\sigma_b - \sigma_c}{2} \cos(2\phi) + \tau_{bc} \sin(2\phi)$$

$$\tau_T = -\frac{\sigma_b - \sigma_c}{2} \sin(2\phi) + \tau_{bc} \cos(2\phi)$$

$$\tau_L = \tau_{ab} \cos \phi + \tau_{ca} \sin \phi$$

d) transverse (matrix) failure: transverse compression/shear,

$$f_{mat} = \left(\frac{\tau_T}{S_T - \mu_T \sigma_n} \right)^2 + \left(\frac{\tau_L}{S_L - \mu_L \sigma_n} \right)^2 = 1 \quad \text{if } \sigma_n < 0$$

2. **Damage Evolution.** As long as the stress state is located within the failure surface, the model behaves in an orthotropic elastic manner. When reaching the failure criteria, the effective (undamaged) stresses will be reduced by a factor of $(1 - d)$, where the damage variable d represents one of the damage variables

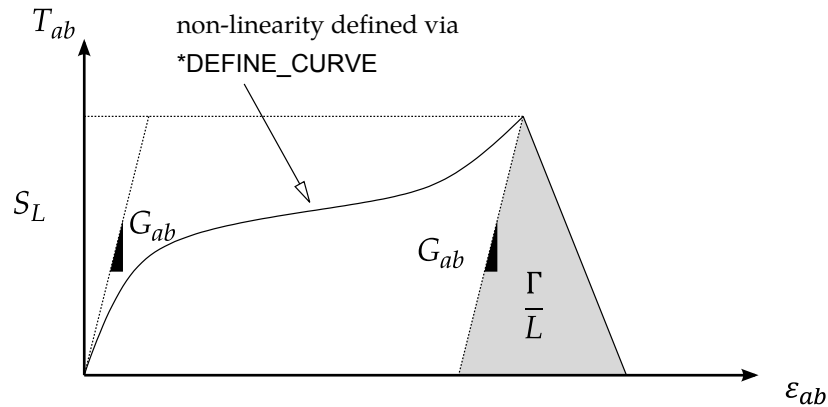

Figure M261-3. Definition of nonlinear in-plane shear behavior

defined for the different failure mechanisms (d_{da} , d_{kink} , d_{mat}). The growth of these damage variables is driven by a linear damage evolution law based on fracture toughnesses ($\Gamma \rightarrow$ ENKINK, ENA, ENB, ENT, ENL) and a characteristic internal element length, L , to account for objectivity. See [Figure M261-2](#).

3. **Nonlinear In-Plane Shear.** To account for the characteristic nonlinear in-plane shear behavior of laminated fiber-reinforced composites, a 1D elasto-plastic formulation is coupled to a linear damage behavior once the maximum allowable stress state for shear failure is reached. The non-linearity of the shear behavior can be introduced using the definition of an explicit shear stress as a function of engineering shear strain curve (LCSS) with `*DEFINE_CURVE`. See [Figure M261-3](#) (in which ϵ_{ab} designates engineering shear strain rather than tensorial shear strain).
4. **Element Deletion.** When failure has occurred in all the composite layers (through-thickness integration points), the element is deleted. Elements that share nodes with the deleted element become “crashfront” elements and can have their strengths reduced by using the `SOFT` parameter. An earlier initiation of crashfront elements is possible by using the parameter `PFL`.
5. **History Variables.** The number of additional integration point variables written to the LS-DYNA database is input by the `*DATABASE_EXTENT_BINARY` definition with the variable `NEIPS` (shells) and `NEIPH` (solids). These additional variables are tabulated below (i = integration point).

When intending to initialize the stress state using `*INITIAL_STRESS_OPTION`, the stress values `SIGXX`, `SIGYY`, etc. in `*INITIAL_STRESS_OPTION` are not used, rather stresses are determined from the total strain history variables 31 to 36.

History Variable	Description	Value	History Variable #
fa(i)	fiber tensile mode	0 → 1: elastic 1: failure criterion reached	1
fkink(i)	fiber compressive mode		2
fmat(i)	matrix mode		3
da(i)	damage fiber tension	0: elastic 1: fully damaged	5
dkink(i)	damage fiber compression		6
dmat(i)	damage transverse		7
dam(i)	crashfront	-1: element intact 10 ⁻⁸ : element in crashfront +1: element failed	9
fmt_p(i)	tensile matrix mode (Puck criteria)	0 → 1: elastic 1: failure criterion reached	10
fmc_p(i)	compressive matrix mode (Puck criteria)		11
theta_p(i)	angle of fracture plane (radians, Puck criteria)		12
d1tot(i)	Total strain in material 11-direction		31
d2tot(i)	Total strain in material 22-direction		32
d3tot(i)	Total strain in material 33-direction		33
d4tot(i)	Total strain in material 12-direction		34
d5tot(i)	Total strain in material 23-direction		35
d6tot(i)	Total strain in material 31-direction		36
theta	Angle θ in Figure M261-1		49
psi	Angle ψ in Figure M261-1		50
e1dot(i)	Averaged strain rate in longitudinal direction		54
e2dot(i)	Averaged strain rate in transverse direction		55
e4dot(i)	Averaged engineering shear strain rate in in- plane direction		56

References:

More detailed information about this material model can be found in Pinho, Iannucci and Robinson [2006].

***MAT_LAMINATED_FRACTURE_DAIMLER_CAMANHO**

This is Material Type 262 which is an orthotropic continuum damage model for laminated fiber-reinforced composites. See Maimí, Camanho, Mayugo and Dávila [2007]. It is based on a physical model for each failure mode and considers a simplified non-linear in-plane shear behavior. This model is implemented for shell, thick shell and solid elements.

NOTE: Laminated shell theory can be applied by setting $LAMSHT \geq 3$ in *CONTROL_SHELL.

Card Summary:

Card 1. This card is required.

MID	RO	EA	EB	EC	PRBA	PRCA	PRCB
-----	----	----	----	----	------	------	------

Card 2. This card is required.

GAB	GBC	GCA	AOPT	DAF	DKF	DMF	EFS
-----	-----	-----	------	-----	-----	-----	-----

Card 3. This card is required.

XP	YP	ZP	A1	A2	A3	DSF	
----	----	----	----	----	----	-----	--

Card 4. This card is required.

V1	V2	V3	D1	D2	D3	MANGLE	MSG
----	----	----	----	----	----	--------	-----

Card 5. This card is required.

GXC	GXT	GYC	GYT	GSL	GXCO	GXTO	
-----	-----	-----	-----	-----	------	------	--

Card 6. This card is required.

XC	XT	YC	YT	SL	XCO	XTO	
----	----	----	----	----	-----	-----	--

Card 7. This card is required.

FIO	SIGY	ETAN	BETA	PFL	PUCK	SOFT	DT
-----	------	------	------	-----	------	------	----

Card 8. This card is optional.

EPSF23	EPSR23	TSMD23	EPSF31	EPSR31	TSMD31		
--------	--------	--------	--------	--------	--------	--	--

Data Card Definitions:

Card 1	1	2	3	4	5	6	7	8
Variable	MID	RO	EA	EB	EC	PRBA	PRCA	PRCB
Type	A	F	F	F	F	F	F	F

VARIABLE**DESCRIPTION**

MID	Material identification. A unique number or label must be specified (see *PART).
RO	Mass density
EA	E_a , Young's modulus in a -direction (longitudinal)
EB	E_b , Young's modulus in b -direction (transverse)
EC	E_c , Young's modulus in c -direction
PRBA	ν_{ba} , Poisson's ratio ba
PRCA	ν_{ca} , Poisson's ratio ca
PRCB	ν_{cb} , Poisson's ratio cb

Card 2	1	2	3	4	5	6	7	8
Variable	GAB	GBC	GCA	AOPT	DAF	DKF	DMF	EFS
Type	F	F	F	F	F	F	F	F

VARIABLE**DESCRIPTION**

GAB	G_{ab} , shear modulus ab
GBC	G_{bc} , shear modulus bc
GCA	G_{ca} , shear modulus ca

VARIABLE	DESCRIPTION
AOPT	<p>Material axes option (see MAT_OPTIONTROPIC_ELASTIC for a more complete description):</p> <p>EQ.0.0: Locally orthotropic with material axes determined by element nodes 1, 2, and 4, as with *DEFINE_COORDINATE_NODES, and then, for shells only, rotated about the shell element normal by an angle MANGLE</p> <p>EQ.1.0: Locally orthotropic with material axes determined by a point in space and the global location of the element center; this is the a-direction. This option is for solid elements only.</p> <p>EQ.2.0: Globally orthotropic with material axes determined by vectors defined below, as with *DEFINE_COORDINATE_VECTOR</p> <p>EQ.3.0: Locally orthotropic material axes determined by rotating the material axes about the element normal by an angle (MANGLE) from a line in the plane of the element defined by the cross product of the vector \mathbf{v} with the element normal</p> <p>EQ.4.0: Locally orthotropic in cylindrical coordinate system with the material axes determined by a vector \mathbf{v}, and an originating point, p, which define the centerline axis. This option is for solid elements only.</p> <p>LT.0.0: The absolute value of AOPT is a coordinate system ID number (CID on *DEFINE_COORDINATE_NODES, *DEFINE_COORDINATE_SYSTEM or *DEFINE_COORDINATE_VECTOR).</p>
DAF	<p>Flag to control failure of an integration point based on longitudinal (fiber) tensile failure:</p> <p>EQ.0.0: Integration point fails if any damage variable reaches 1.0.</p> <p>EQ.1.0: No failure of integration point due to fiber tensile failure, $da(i) = 1.0$</p>
DKF	<p>Flag to control failure of an integration point based on longitudinal (fiber) compressive failure:</p> <p>EQ.0.0: Integration point fails if any damage variable reaches 1.0.</p>

VARIABLE	DESCRIPTION
	EQ.1.0: No failure of integration point due to fiber compressive failure, $dkink(i) = 1.0$.
DMF	<p>Flag to control failure of an integration point based on transverse (matrix) failure:</p> <p>EQ.0.0: Integration point fails if any damage variable reaches 1.0.</p> <p>EQ.1.0: No failure of integration point due to matrix failure, $dmat(i) = 1.0$</p>
EFS	<p>Maximum effective strain for element layer failure. A value of unity would equal 100% strain.</p> <p>GT.0.0: Fails when effective strain calculated assuming material is volume preserving exceeds EFS</p> <p>LT.0.0: Fails when effective strain calculated from the full strain tensor exceeds EFS </p>

Card 3	1	2	3	4	5	6	7	8
Variable	XP	YP	ZP	A1	A2	A3	DSF	
Type	F	F	F	F	F	F	F	

VARIABLE	DESCRIPTION
XP YP ZP	Coordinates of point p for AOPT = 1 and 4
A1 A2 A3	Components of vector \mathbf{a} for AOPT = 2
DSF	<p>Flag to control failure of an integration point based on in-plane shear failure:</p> <p>EQ.0.0: Integration point fails if any damage variable reaches 1.0.</p> <p>EQ.1.0: No failure of integration point due to in-plane shear failure, $dsl(i) = 1.0$</p>

Card 4	1	2	3	4	5	6	7	8
Variable	V1	V2	V3	D1	D2	D3	MANGLE	MSG
Type	F	F	F	F	F	F	F	F

VARIABLE**DESCRIPTION**

V1 V2 V3	Components of vector v for AOPT = 3
D1 D2 D3	Components of vector d for AOPT = 2
MAN- GLE	Material angle in degrees for AOPT = 0 (shells only) and AOPT = 3. MANGLE may be overridden on the element card; see *ELEMENT_SHELL_BETA and *ELEMENT_SOLID_ORTHO.
MSG	Flag to control the output of warning messages: EQ.0: Only one warning message will be written per part. GT.0: All warnings are written. LT.0: No warnings are written.

Card 5	1	2	3	4	5	6	7	8
Variable	GXC	GXT	GYC	GYT	GSL	GXCO	GXT0	
Type	F	F	F	F	F	F	F	

VARIABLE**DESCRIPTION**

GXC	Fracture toughness for longitudinal (fiber) compressive failure mode. GT.0.0: The given value will be regularized with the characteristic element length.
-----	--

VARIABLE	DESCRIPTION
	<p>LT.0.0: Load curve ID = (-GXC) which defines the fracture toughness for fiber compressive failure mode as a function of characteristic element length. No further regularization.</p> <p>Table ID = (-GXC) which defines for each strain rate value a load curve that defines the fracture toughness for fiber compressive failure mode as a function of characteristic element length. No further regularization.</p>
GXT	<p>Fracture toughness for longitudinal (fiber) tensile failure mode:</p> <p>GT.0.0: The given value will be regularized with the characteristic element length.</p> <p>LT.0.0: Load curve ID = (-GXT) which defines the fracture toughness for fiber tensile failure mode as a function of characteristic element length. No further regularization.</p> <p>Table ID = (-GXT) which defines for each strain rate value a load curve that defines the fracture toughness for fiber tensile failure mode as a function of characteristic element length. No further regularization.</p>
GYC	<p>Fracture toughness for transverse compressive failure mode.</p> <p>GT.0.0: The given value will be regularized with the characteristic element length.</p> <p>LT.0.0: Load curve ID = (-GYC) which defines the fracture toughness for transverse compressive failure mode as a function of characteristic element length. No further regularization.</p> <p>Table ID = (-GYC) which defines for each strain rate value a load curve that defines the fracture toughness for transverse compressive failure mode as a function of characteristic element length. No further regularization.</p>
GYT	<p>Fracture toughness for transverse tensile failure mode.</p> <p>GT.0.0: The given value will be regularized with the characteristic element length.</p>

VARIABLE	DESCRIPTION
	<p>LT.0.0: Load curve ID = (-GYT) which defines the fracture toughness for transverse tensile failure mode as a function of characteristic element length. No further regularization.</p> <p>Table ID = (-GYT) which defines for each strain rate value a load curve that defines the fracture toughness for transverse tensile failure mode as a function of characteristic element length. No further regularization.</p>
GSL	<p>Fracture toughness for in-plane shear failure mode.</p> <p>GT.0.0: The given value will be regularized with the characteristic element length.</p> <p>LT.0.0: Load curve ID = (-GSL) which defines the fracture toughness for in-plane shear failure mode as a function of characteristic element length. No further regularization.</p> <p>Table ID = (-GSL) which defines for each strain rate value a load curve that defines the fracture toughness for in-plane shear failure mode as a function of characteristic element length. No further regularization.</p>
GXCO	<p>Fracture toughness for longitudinal (fiber) compressive failure mode to define bi-linear damage evolution.</p> <p>GT.0.0: The given value will be regularized with the characteristic element length.</p> <p>LT.0.0: Load curve ID = (-GXCO) which defines the fracture toughness for fiber compressive failure mode to define bi-linear damage evolution as a function of characteristic element length. No further regularization.</p> <p>Table ID = (-GXCO) which defines for each strain rate value a load curve that defines the fracture toughness for fiber compressive failure mode to define bi-linear damage evolution as a function of characteristic element length. No further regularization.</p>
GXTO	<p>Fracture toughness for longitudinal (fiber) tensile failure mode to define bi-linear damage evolution.</p>

VARIABLE	DESCRIPTION
----------	-------------

GT.0.0: The given value will be regularized with the characteristic element length.

LT.0.0: Load curve ID = (-GXTO) which defines the fracture toughness for fiber tensile failure mode to define bi-linear damage evolution as a function of characteristic element length. No further regularization.

Table ID = (-GXTO) which defines for each strain rate value a load curve that defines the fracture toughness for fiber tensile failure mode to define bi-linear damage evolution as a function of characteristic element length. No further regularization.

Card 6	1	2	3	4	5	6	7	8
Variable	XC	XT	YC	YT	SL	XCO	XTO	
Type	F	F	F	F	F	F	F	

VARIABLE	DESCRIPTION
----------	-------------

XC Longitudinal compressive strength, *a*-axis (positive value):
 GT.0.0: Constant value
 LT.0.0: Load curve ID = (-XC) which defines the longitudinal compressive strength as a function of longitudinal strain rate ($\dot{\epsilon}_{aa}$)

XT Longitudinal tensile strength, *a*-axis:
 GT.0.0: Constant value
 LT.0.0: Load curve ID = (-XT) which defines the longitudinal tensile strength as a function of longitudinal strain rate ($\dot{\epsilon}_{aa}$)

YC Transverse compressive strength, *b*-axis (positive value):
 GT.0.0: Constant value
 LT.0.0: Load curve ID = (-YC) which defines the transverse compressive strength as a function of transverse strain rate ($\dot{\epsilon}_{bb}$)

VARIABLE	DESCRIPTION
YT	<p>Transverse tensile strength, <i>b</i>-axis:</p> <p>GT.0.0: Constant value</p> <p>LT.0.0: Load curve ID = (-YT) which defines the transverse tensile strength as a function of transverse strain rate ($\dot{\epsilon}_{bb}$)</p>
SL	<p>Shear strength, <i>ab</i> plane:</p> <p>GT.0.0: Constant value</p> <p>LT.0.0: Load curve ID = (-SL) which defines the longitudinal shear strength as a function of in-plane shear strain rate ($\dot{\epsilon}_{ab}$)</p>
XCO	<p>Longitudinal compressive strength at inflection point (positive value):</p> <p>GT.0.0: Constant value</p> <p>LT.0.0: Load curve ID = (-XCO) which defines the longitudinal compressive strength at inflection point as a function of longitudinal strain rate ($\dot{\epsilon}_{aa}$).</p>
XTO	<p>Longitudinal tensile strength at inflection point:</p> <p>GT.0.0: Constant value</p> <p>LT.0.0: Load curve ID = (-XTO) which defines the longitudinal tensile strength at inflection point as a function of longitudinal strain rate ($\dot{\epsilon}_{aa}$)</p>

Card 7	1	2	3	4	5	6	7	8
Variable	FIO	SIGY	ETAN	BETA	PFL	PUCK	SOFT	DT
Type	F	F	F	F	F	F	F	F

VARIABLE	DESCRIPTION
FIO	Fracture angle in pure transverse compression (in degrees, default = 53.0)

VARIABLE	DESCRIPTION
SIGY	In-plane shear yield stress: GT.0.0: Constant value LT.0.0: Load curve ID = (-SIGY) which defines the in-plane shear yield stress as a function of in-plane shear strain rate ($\dot{\epsilon}_{ab}$)
ETAN	Tangent modulus for in-plane shear plasticity: GT.0.0: Constant value LT.0.0: Load curve ID = (-ETAN) which defines the tangent modulus for in-plane shear plasticity as a function of in-plane shear strain rate ($\dot{\epsilon}_{ab}$)
BETA	Hardening parameter for in-plane shear plasticity ($0.0 \leq \text{BETA} \leq 1.0$): EQ.0.0: Pure kinematic hardening EQ.1.0: Pure isotropic hardening $0.0 < \text{BETA} < 1.0$: Mixed hardening
PFL	Percentage of layers which must fail before crashfront is initiated. For example, if $ \text{PFL} = 80.0$, then 80% of the layers must fail before strengths are reduced in neighboring elements. By default, all layers must fail. A single layer fails if 1 in-plane IP fails ($\text{PFL} > 0$) or if 4 in-plane IPs fail ($\text{PFL} < 0$).
PUCK	Flag for evaluation and post-processing of Puck's inter-fiber-failure criterion (IFF, see Puck, Kopp and Knops [2002]). EQ.0.0: No evaluation of Puck's IFF-criterion EQ.1.0: Puck's IFF-criterion will be evaluated.
SOFT	Softening reduction factor for material strength in crashfront elements (default = 1.0)
DT	Strain rate averaging option: EQ.0.0: Strain rate is evaluated using a running average. LT.0.0: Strain rate is evaluated using average of last 11 time steps. GT.0.0: Strain rate is averaged over the last DT time units.

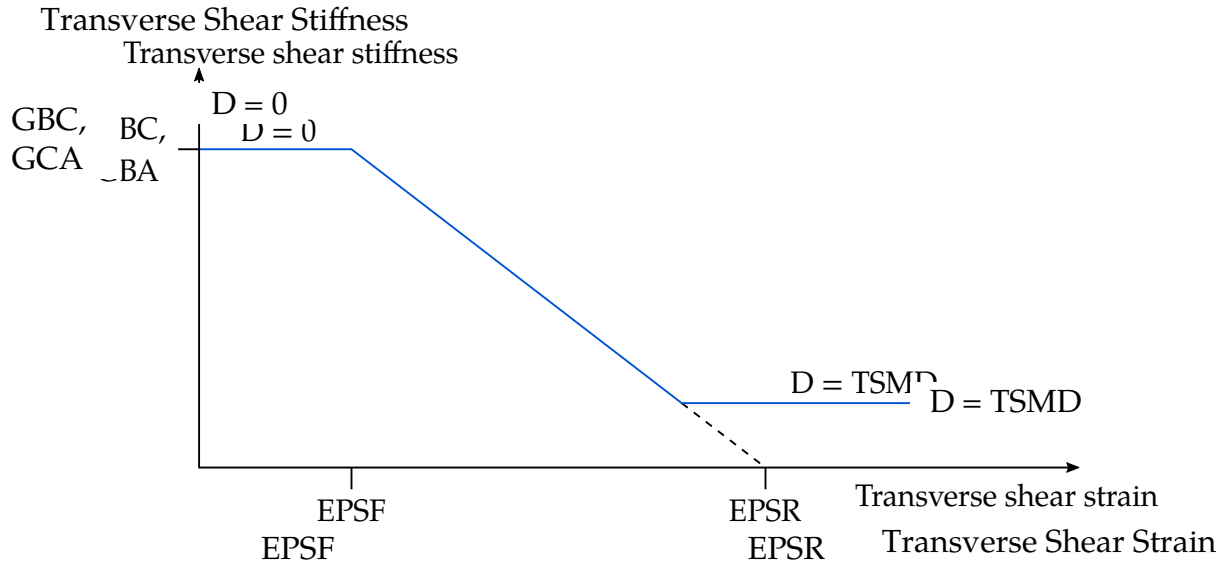

Figure M262-1. Linear Damage for Transverse Shear Behavior

Optional Transverse Shear Failure Card. This card is optional.

Card 8	1	2	3	4	5	6	7	8
Variable	EPSF23	EPSR23	TSMD23	EPSF31	EPSR31	TSMD31		
Type	F	F	F	F	F	F		

VARIABLE

DESCRIPTION

EPSF23	Damage initiation transverse shear strain (23-plane)
EPSR23	Final rupture transverse shear strain (23-plane)
TSMD23	Transverse shear maximum damage; default = 0.90 (23-plane).
EPSF31	Damage initiation transverse shear strain (31-plane)
EPSR31	Final rupture transverse shear strain (31-plane)
TSMD31	Transverse shear maximum damage; default = 0.90 (31-plane).

Remarks:

The failure surface to limit the elastic domain is assembled by *four* sub-surfaces, representing different failure mechanisms. They are defined as follows:

1. longitudinal (fiber) tension,

$$\phi_{1+} = \frac{\sigma_{11} - \nu_{12}\sigma_{22}}{X_T} = 1$$

2. longitudinal (fiber) compression – (transformation to fracture plane),

$$\phi_{1-} = \frac{\langle |\sigma_{12}^m| + \mu_L \sigma_{22}^m \rangle}{S_L} = 1$$

with

$$\begin{aligned} \mu_L &= -\frac{S_L \cos(2\phi_0)}{Y_C \cos^2(\phi_0)} \\ \sigma_{22}^m &= \sigma_{11} \sin^2(\varphi^c) + \sigma_{22} \cos^2(\varphi^c) - 2|\sigma_{12}| \sin(\varphi^c) \cos(\varphi^c) \\ \sigma_{12}^m &= (\sigma_{22} - \sigma_{11}) \sin(\varphi^c) \cos(\varphi^c) + |\sigma_{12}| (\cos^2(\varphi^c) - \sin^2(\varphi^c)) \end{aligned}$$

and

$$\varphi^c = \arctan \left[\frac{1 - \sqrt{1 - 4 \left(\frac{S_L}{X_C} + \mu_L \right) \frac{S_L}{X_C}}}{2 \left(\frac{S_L}{X_C} + \mu_L \right)} \right]$$

3. transverse (matrix) failure: perpendicular to the laminate mid-plane,

$$\phi_{2+} = \begin{cases} \sqrt{(1-g) \frac{\sigma_{22}}{Y_T} + g \left(\frac{\sigma_{22}}{Y_T} \right)^2 + \left(\frac{\sigma_{12}}{S_L} \right)^2} = 1 & \sigma_{22} \geq 0 \\ \frac{\langle |\sigma_{12}| + \mu_L \sigma_{22} \rangle}{S_L} = 1 & \sigma_{22} < 0 \end{cases}$$

4. transverse (matrix) failure: transverse compression/shear,

$$\phi_{2-} = \sqrt{\left(\frac{\tau_T}{S_T} \right)^2 + \left(\frac{\tau_L}{S_L} \right)^2} = 1 \quad \text{if} \quad \sigma_{22} < 0$$

with

$$\begin{aligned} \mu_T &= -\frac{1}{\tan(2\phi_0)} \\ S_T &= Y_C \cos(\phi_0) \left[\sin(\phi_0) + \frac{\cos(\phi_0)}{\tan(2\phi_0)} \right] \\ \theta &= \arctan \left(\frac{-|\sigma_{12}|}{\sigma_{22} \sin(\phi_0)} \right) \\ \tau_T &= \langle -\sigma_{22} \cos(\phi_0) [\sin(\phi_0) - \mu_T \cos(\phi_0) \cos(\theta)] \rangle \\ \tau_L &= \langle \cos(\phi_0) [|\sigma_{12}| + \mu_L \sigma_{22} \cos(\phi_0) \sin(\theta)] \rangle \end{aligned}$$

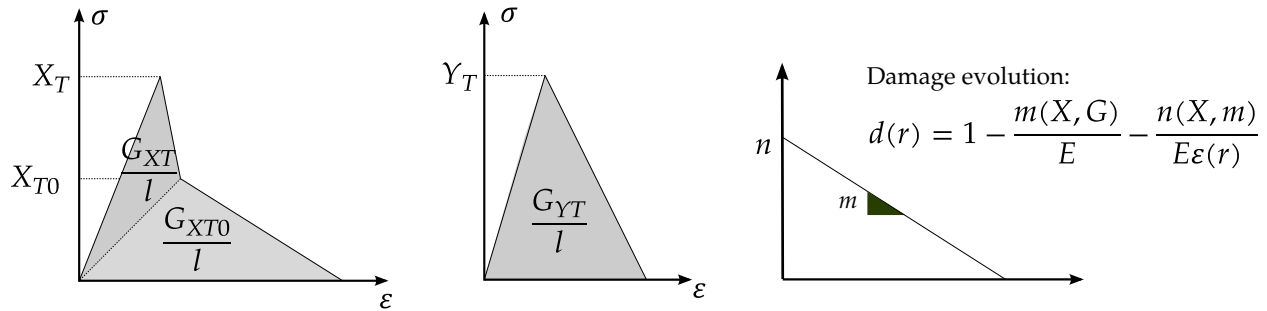

Figure M262-2. Damage evolution law

So long as the stress state is located within the failure surface the model behaves orthotropic elastic. The constitutive law is derived on basis of a proper definition for the ply complementary free energy density G , whose second derivative with respect to the stress tensor leads to the compliance tensor \mathbf{H}

$$\mathbf{H} = \frac{\partial^2 G}{\partial \sigma^2} = \begin{bmatrix} \frac{1}{(1-d_1)E_1} & -\frac{\nu_{21}}{E_2} & 0 \\ -\frac{\nu_{12}}{E_1} & \frac{1}{(1-d_2)E_2} & 0 \\ 0 & 0 & \frac{1}{(1-d_6)G_{12}} \end{bmatrix}, \quad \begin{aligned} d_1 &= d_{1+} \frac{\langle \sigma_{11} \rangle}{|\sigma_{11}|} + d_{1-} \frac{\langle -\sigma_{11} \rangle}{|\sigma_{11}|} \\ d_2 &= d_{2+} \frac{\langle \sigma_{22} \rangle}{|\sigma_{22}|} + d_{2-} \frac{\langle -\sigma_{22} \rangle}{|\sigma_{22}|} \end{aligned}$$

Once the stress state reaches the failure criterion, a set of scalar damage variables (d_{1-} , d_{1+} , d_{2-} , d_{2+} , d_6) is introduced associated with the different failure mechanisms. A bi-linear (longitudinal direction) and a linear (transverse direction) damage evolution law is used to define the development of the damage variables driven by the fracture toughness and a characteristic internal element length to account for objectivity. See [Figure M262-2](#).

To account for the characteristic non-linear in-plane shear behavior of laminated fiber-reinforced composites a 1D elasto-plastic formulation with linear hardening is coupled to a linear damage behavior once the maximum allowable stress state for shear failure is reached. See [Figure M262-3](#).

More detailed information about this material model can be found in Maimí, Camanho, Mayugo and Dávila [2007].

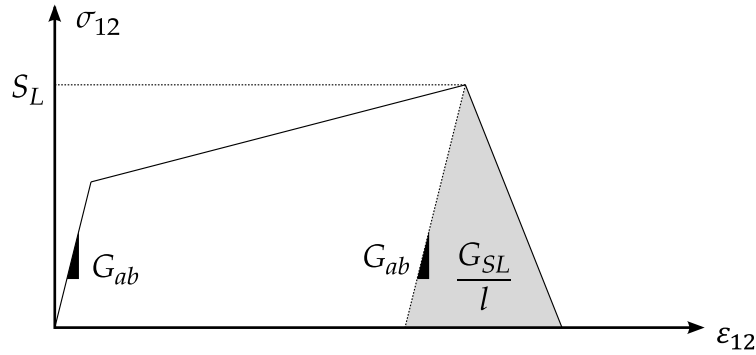

Figure M262-3. In-plane shear behavior

When failure has occurred in all the composite layers (through-thickness integration points), the element is deleted. Elements which share nodes with the deleted element become “crashfront” elements and can have their strengths reduced by using the SOFT parameter. An earlier initiation of crashfront elements is possible by using the parameter PFL.

The number of additional integration point variables written to the LS-DYNA database is input by the *DATABASE_EXTENT_BINARY definition with the variable NEIPS (shells) and NEIPH (solids). These additional variables are tabulated below (*i* = integration point).

When intending to initialize the stress state using *INITIAL_STRESS_OPTION, the stress values SIGXX, SIGYY, etc. in *INITIAL_STRESS_OPTION are not used, rather stresses are determined from the total strain history variables 31 to 36.

History Variable	Description	Value	LS-PrePost history variable
$\phi_{1+}(i)$	fiber tensile mode	0 → 1: elastic 1: failure criterion reached	1
$\phi_{1-}(i)$	fiber compressive		2
$\phi_{2+}(i)$	tensile matrix mode		3
$\phi_{2-}(i)$	compressive matrix mode		4
$d_{1+}(i)$	damage fiber tension	0: elastic 1: fully damaged	5
$d_{1-}(i)$	damage fiber compression		6
$d_2(i)$	damage transverse		7
$d_6(i)$	damage in-plane shear		8

History Variable	Description	Value	LS-PrePost history variable
dam(<i>i</i>)	crashfront	-1: element intact 10 - 8: element in crashfront +1: element failed	9
fmt_p(<i>i</i>)	tensile matrix mod (Puck criteria)	0 → 1: elastic 1: failure criterion reached	10
fmc_p(<i>i</i>)	compressive matrix mode (Puck criteria)		11
theta_p(<i>i</i>)	angle of fracture plane (radians, Puck criteria)		12
$d_1(i)$	damage longitudinal	0: elastic 1: fully damaged	16
$d_{2+}(i)$	damage transverse tension		17
$d_{2-}(i)$	damage transverse compression		18
d1tot(<i>i</i>)	Total strain in mat 11-direction		31
d2tot(<i>i</i>)	Total strain in mat 22-direction		32
d3tot(<i>i</i>)	Total strain in mat 33-direction		33
d4tot(<i>i</i>)	Total strain in mat 12-direction		34
d5tot(<i>i</i>)	Total strain in mat 23-direction		35
d6tot(<i>i</i>)	Total strain in mat 31-direction		36
e1dot(<i>i</i>)	Averaged strain rate in longitudinal direction		55
e2dot(<i>i</i>)	Averaged strain rate in transverse direction		56
e4dot(<i>i</i>)	Averaged engineering shear strain rate in in-plane direction		57

***MAT_LOU-YOON_ANISOTROPIC_PLASTICITY**

This is Material Type 263. It is based on the anisotropic yield function proposed by Lou and Yoon (Lou and Yoon, 2017). This yield function extends the original Drucker function into an anisotropic form using a fourth order linear transformation tensor. The non-associated flow rule (non-AFR) can be applied to accurately describe both the directional yield stresses and *R*-values. The anisotropic flexibility of this model can be further improved by summing up components of the anisotropic Drucker function. See the section [Constitutive relations](#) below for more details. This model is supported for shell and solid elements.

Card 1	1	2	3	4	5	6	7	8
Variable	MID	RO	E	PR	HR	P1	P2	ITER
Type	A	F	F	F	F	F	F	F
Default	none	none	none	none	none	none	none	0.0

Card 2	1	2	3	4	5	6	7	8
Variable	AFR	NFUNC	AOPT		LCID	E0	LCF	P3
Type	I	I	F		I	F	I	
Default	none	1	none		none	none	none	none

Card 3	1	2	3	4	5	6	7	8
Variable				A1	A2	A3		
Type				F	F	F		
Default				none	none	none		

MAT_263**MAT_LOU-YOON_ANISOTROPIC_PLASTICITY**

Card 4	1	2	3	4	5	6	7	8
Variable	V1	V2	V3	D1	D2	D3		
Type	F	F	F	F	F	F		
Default	none	none	none	none	none	none		

Card 5	1	2	3	4	5	6	7	8
Variable	C1	C2	C3	C4	C5	C6	CC	
Type	F	F	F	F	F	F	F	
Default	none	none	none	none	none	none	none	

Card 6	1	2	3	4	5	6	7	8
Variable	PC1	PC2	PC3	PC4	PC5	PC6	PCC	
Type	F	F	F	F	F	F	F	
Default	none	none	none	none	none	none	none	

Optional card that only needs to be included if $LCF < 0$.

Card 7	1	2	3	4	5	6	7	8
Variable	VF1	VF2	VF3	VF4	VF5			
Type	F	F	F	F	F			

VARIABLE**DESCRIPTION**

MID

Material identification. A unique number or label must be specified (see *PART).

VARIABLE	DESCRIPTION
RO	Mass density
E	Young's modulus
PR	Poisson's ratio
HR	Hardening rules (see section Hardening laws below): EQ.1.0: Linear hardening (default) EQ.2.0: Exponential hardening (Swift) EQ.3.0: Load curve EQ.4.0: Exponential hardening (Voce) EQ.5.0: Exponential hardening (Gosh) EQ.6.0: Exponential hardening (Hocken-Sherby)
P1	Material parameter: HR.EQ.1.0: Tangent modulus HR.EQ.2.0: q , coefficient for exponential hardening law (Swift) HR.EQ.4.0: a , coefficient for exponential hardening law (Voce) HR.EQ.5.0: q , coefficient for exponential hardening law (Gosh) HR.EQ.6.0: a , coefficient for exponential hardening law (Hockett-Sherby)
P2	Material parameter: HR.EQ.1.0: Yield stress for the linear hardening law HR.EQ.2.0: n , coefficient for (Swift) exponential hardening HR.EQ.4.0: c , coefficient for exponential hardening law (Voce) HR.EQ.5.0: n , coefficient for exponential hardening law (Gosh) HR.EQ.6.0: c , coefficient for exponential hardening law (Hockett-Sherby)
ITER	Iteration flag for speed: EQ.0.0: Fully iterative EQ.1.0: Fixed at three iterations. Generally, ITER = 0.0 is recommended. However, ITER = 1.0 is faster and may give acceptable results in most problems.

VARIABLE	DESCRIPTION
AFR	Flag to use associated flow rule (AFR): EQ.0: Use non-AFR. EQ.1: Use AFR.
NFUNC	Number of Drucker function components. Currently NFUNC is always set to 1.
AOPT	Material axes option (see MAT_OPTIONTROPIC_ELASTIC for more complete description). EQ.0.0: Locally orthotropic with material axes determined by element nodes. The shells only the material axes are rotated about the normal vector to the surface of the shell by the angle BETA. EQ.2.0: Globally orthotropic with material axes determined by vectors defined a and d defined below, as with *DEFINED_COORDINATE_VECTOR. EQ.3.0: Locally orthotropic material axes determined by a vector v and the normal vector to the plane of the element. The plane of a solid element is the midsurface between the inner surface and outer surface defined by the first four nodes and the last four nodes of the connectivity of the element, respectively. Thus, for solid elements, AOPT = 3 is only available for hexahedrons. The material directions are determined as follows: a is the cross product of v with the normal vector, b is the cross product of the normal vector with a , and c is the normal vector. Then a and b are rotated about c by an angle BETA. BETA may be set in the keyword input for the element. LT.0.0: The absolute value of AOPT is a coordinate system ID (CID on *DEFINE_COORDINATE_NODES, *DEFINE_COORDINATE_SYSTEM, or *DEFINE_COORDINATE_VECTOR).
LCID	Load curve ID giving the hardening law for HR = 3

VARIABLE	DESCRIPTION
E0	<p>Material parameter:</p> <p>HR.EQ.2.0: ε_0, initial yield strain for exponential hardening law (Swift) (default = 0.0)</p> <p>HR.EQ.4.0: b, coefficient for exponential hardening (Voce)</p> <p>HR.EQ.5.0: ε_0, initial yield strain for exponential hardening (Gosh), Default = 0.0</p> <p>HR.EQ.6.0: b, coefficient for exponential hardening law (Hockett-Sherby)</p>
LCF	<p>Fracture curve:</p> <p>EQ.0: No fracture curves (default)</p> <p>GT.0: Load curve or table ID of customized fracture curve/surface. If referring to a load curve ID, the fracture curve is defined as effective plastic strain as a function of triaxiality. If referring to a table ID, for each load parameter, an effective plastic strain as a function of triaxiality curve can be defined (only applicable to solids)</p> <p>EQ.-1: Drucker ductile fracture criterion. Optional Card 7 is needed in this case. VF1, VF2 and VF3 in Card 7 will be used as a, b and c in the Drucker ductile fracture criterion. See section Fracture criteria for more details.</p> <p>EQ.-2: DF2016 fracture criterion. Optional card 7 is needed in this case. VF1, VF2, VF3, VF4 and VF5 in Card 7 will be used as C1, C2, C3 and C in DF2016 criterion. See section Fracture criteria for more details.</p>
P3	<p>Material parameter:</p> <p>HR.EQ.5.0: p, coefficient for exponential hardening (Gosh)</p> <p>HR.EQ.6.0: n, exponent for exponential hardening law (Hockett-Sherby)</p>
A1, A2, A3	Components of vector a for AOPT = 2.0
V1, V2, V3	Components of vector v for AOPT = 3.0
D1, D2, D3	Components of vector d for AOPT = 2.0
C_i	Anisotropic parameters c'_1 through c'_6 that defines the fourth order linear transformation tensor L'

VARIABLE	DESCRIPTION
CC	Material constant c in Drucker yield function. c is recommended to be 1.226 for BCC metals and 2 for FCC metals.
PC <i>i</i>	Anisotropic parameters \hat{c}_1 through \hat{c}_6 that defines the fourth order linear transformation tensor \hat{L} for the plastic potential in the non-AFR case (see field AFR which is input on Card 2).
PCC	Material constant \hat{c} in Drucker function for the plastic potential. \hat{c} is recommended to be 1.226 for BCC metals and 2 for FCC metals unless calibrated otherwise.
VFi	Components of the fracture criterion included for LCF < 0. See LCF (input on Card 2) for a description.

Hardening laws:

The implemented hardening laws are the following:

1. The Swift hardening law
2. The Voce hardening law
3. The Gosh hardening law
4. The Hocket-Sherby hardening law
5. A loading curve, where the yield stress is given as a function of the effective plastic strain

The Swift hardening law can be written as:

$$\sigma_y(\varepsilon_{ep}) = q(\varepsilon_0 + \varepsilon_{ep})^n ,$$

where q and n are material parameters.

The Voce equation says that the yield stress can be written in the following form:

$$\sigma_y(\varepsilon_{ep}) = a - be^{-c\varepsilon_{ep}} ,$$

where a , b and c are material parameters. The Gosh equation is similar to the Swift equation. They only differ by a constant

$$\sigma_y(\varepsilon_{ep}) = q(\varepsilon_0 + \varepsilon_{ep})^n - p ,$$

where q , ε_0 , n and p are material constants. The Hocket-Sherby equation resemblance the Voce equation, but with an additional parameter added

$$\sigma_y(\varepsilon_{ep}) = a - be^{-c\varepsilon_{ep}^n} .$$

where a, b, c and n are material parameters.

Constitutive relations:

Drucker proposed a yield function that includes the effect of the third stress invariant in the classic Von Mises yield function. Lou and Yoon (2017) extended this yield function to an anisotropic form as shown below:

$$\bar{\sigma}_y(\sigma_{ij}) = (J_2^3 - cJ_3^2)^{1/6} .$$

Here J_2 and J_3 are the second and third invariants of the linear transformed deviatoric stress tensor \mathbf{s}' :

$$\mathbf{s}' = \mathbf{L}'\boldsymbol{\sigma} .$$

The fourth order linear transformation tensor \mathbf{L}' is given by:

$$\mathbf{L}' = \begin{bmatrix} (c'_2 + c'_3)/3 & -c'_3/3 & -c'_2/3 & 0 & 0 & 0 \\ -c'_3/3 & (c'_1 + c'_3)/3 & -c'_1/3 & 0 & 0 & 0 \\ -c'_2/3 & -c'_1/3 & (c'_2 + c'_1)/3 & 0 & 0 & 0 \\ 0 & 0 & 0 & c'_4 & 0 & 0 \\ 0 & 0 & 0 & 0 & c'_5 & 0 \\ 0 & 0 & 0 & 0 & 0 & c'_6 \end{bmatrix} .$$

c'_1, c'_2, c'_3 and c'_6 can be calibrated from uniaxial tensile yield stress along different directions and the balanced biaxial yield stress. c'_4 and c'_5 , which are related to the through-thickness material properties, are very difficult to obtain experimentally and therefore assumed to be identical with c'_6 .

With the non-associated flow rule (non-AFR), the plastic flow is not necessarily aligned with the yield surface normal and the R -values are modeled by a different plastic potential:

$$\bar{\sigma}_p(\sigma_{ij}) = (\hat{J}_2^3 - c\hat{J}_3^2)^{1/6} .$$

Here \hat{J}_2 and \hat{J}_3 are the second and third invariants of the linear transformed deviatoric stress tensor:

$$\hat{\mathbf{s}} = \hat{\mathbf{L}}\boldsymbol{\sigma} .$$

And $\hat{\mathbf{L}}$ is defined as:

$$\hat{\mathbf{L}} = \begin{bmatrix} (\hat{c}_2 + \hat{c}_3)/3 & -\hat{c}_3/3 & -\hat{c}_2/3 & 0 & 0 & 0 \\ -\hat{c}_3/3 & (\hat{c}_1 + \hat{c}_3)/3 & -\hat{c}_1/3 & 0 & 0 & 0 \\ -\hat{c}_2/3 & -\hat{c}_1/3 & (\hat{c}_2 + \hat{c}_1)/3 & 0 & 0 & 0 \\ 0 & 0 & 0 & \hat{c}_4 & 0 & 0 \\ 0 & 0 & 0 & 0 & \hat{c}_5 & 0 \\ 0 & 0 & 0 & 0 & 0 & \hat{c}_6 \end{bmatrix} .$$

The anisotropic parameters \hat{c}_1 , \hat{c}_2 , \hat{c}_3 and \hat{c}_6 can be calibrated with experimentally measured R -values along different directions.

Another approach to improve the flexibility of the yield function is to sum up n components of the anisotropic Drucker functions as follows:

$$\bar{\sigma}_y(\sigma_{ij}) = \frac{1}{n} \sum_{m=1}^n \{[(J_2^{(m)})^3 - c(J_3^{(m)})^2]^{1/6}\} .$$

where n is an integer with $n \geq 1$. The same idea can be applied to the plastic potential in the non-AFR approach, as shown in equation:

$$\bar{\sigma}_p(\sigma_{ij}) = \frac{1}{n} \sum_{m=1}^n \{[(\hat{J}_2^{(m)})^3 - c(\hat{J}_3^{(m)})^2]^{1/6}\} .$$

Fracture criteria:

The Drucker ductile fracture criterion is given by:

$$\bar{\sigma}_f(\sigma_{ij}) = a \left(bI_1 + (J_2^3 - cJ_3^2)^{1/6} \right) = 1$$

The DF2016 fracture criterion is given by:

$$\left(\frac{\sigma_1 - \sigma_3}{\bar{\sigma}_{VM}} \right)^{C_1} \left(\left\langle \frac{f(\eta, L, C)}{f(1/3, -1, C)} \right\rangle \right)^{C_2} \bar{\epsilon}_f^p = C_3$$

Here

$$\langle x \rangle = \begin{cases} x & \text{if } x \geq 0 \\ 0 & \text{if } x < 0 \end{cases}$$

and

$$f(\eta, L, C) = \eta + C_4 \frac{(3-L)}{3\sqrt{L^2+3}} + C .$$

*MAT_TABULATED_JOHNSON_COOK_ORTHO_PLASTICITY

This is Material Type 264. This is an orthotropic elastic plastic material law with J3 dependent yield surface. This material considers tensile/compressive asymmetry in the material response, which is important for HCP metals like titanium. This model is available for solid elements.

Card Summary:

Card 1. This card is required.

MID	RO	E	PR	CP	TR	BETA	NUMINT
-----	----	---	----	----	----	------	--------

Card 2. This card is required.

LCT00R	LCT00T	LCF	LCG	LCH	LCI		
--------	--------	-----	-----	-----	-----	--	--

Card 3. This card is required.

LCC00R	LCC00T	LCS45R	LCS45T	IFLAG	SFIEPM	NITER	AOPT
--------	--------	--------	--------	-------	--------	-------	------

Card 4. This card is required.

LCT90R	LCT45R	LCTTHR	LCC90R	LCC45R	LCCTHR		
--------	--------	--------	--------	--------	--------	--	--

Card 5. This card is required.

LCT90T	LCT45T	LCTTHT	LCC90T	LCC45T	LCCTHT		
--------	--------	--------	--------	--------	--------	--	--

Card 6. This card is required.

XP	YP	ZP	A1	A2	A3	MACF	
----	----	----	----	----	----	------	--

Card 7. This card is required.

V1	V2	V3	D1	D2	D3	MANGLE	
----	----	----	----	----	----	--------	--

Data Card Definitions:

Card 1	1	2	3	4	5	6	7	8
Variable	MID	RO	E	PR	CP	TR	BETA	NUMINT
Type	A	F	F	F	F	F	F	F
Default	none	none	none	none	none	0.0	1.0	1.0

VARIABLE**DESCRIPTION**

MID	Material identification. A unique number or label must be specified (see *PART).
RO	Mass density
E	Young's modulus: GT.0.0: constant value is used. LT.0.0: temperature dependent Young's modulus given by load curve ID = -E
PR	Poisson's ratio
CP	Specific heat
TR	Room temperature
BETA	Fraction of plastic work converted into heat
NUMINT	Number of integration points which must fail before the element is deleted. EQ.-200: Turns off erosion for solids. Not recommended unless used with *CONSTRAINED_TIED_NODES_FAILURE.

Card 2	1	2	3	4	5	6	7	8
Variable	LCT00R	LCT00T	LCF	LCG	LCH	LCI		
Type	I	I	I	I	I	I		
Default	0	0	0	0	0	0		

VARIABLE**DESCRIPTION**

LCT00R	Table ID defining for each plastic strain rate value a load curve ID giving the (isothermal) tensile yield stress as a function of plastic strain for that rate in the 00 degree direction
LCT00T	Table ID defining for each temperature value a load curve ID giving the (quasi-static) tensile yield stress as a function of plastic strain for that temperature in the 00 degree direction
LCF	Load curve or table ID. The load curve ID defines plastic failure strain as a function of triaxiality. The table ID defines for each Lode parameter a load curve ID giving the plastic failure strain as a function of triaxiality for that Lode parameter. (Table option not yet generally supported.)
LCG	Load curve ID defining plastic failure strain as a function of plastic strain rate
LCH	Load curve ID defining plastic failure strain as a function of temperature
LCI	Load curve ID or table ID. The load curve ID defines plastic failure strain as a function of element size. The table ID defines for each triaxiality a load curve ID giving the plastic failure strain as a function of element size for that triaxiality.

Card 3	1	2	3	4	5	6	7	8
Variable	LCC00R	LCC00T	LCS45R	LCS45T	IFLAG	SFIEPM	NITER	AOPT
Type	I	I	I	I	I	I	I	F
Default	0	0	0	0	0	1	100	none

VARIABLE**DESCRIPTION**

LCC00R	Table ID. The curves in this table define compressive yield stress as a function of plastic strain. The table ID defines for each plastic strain rate value a load curve ID giving the (isothermal) compressive yield stress as a function of plastic strain for that rate in the 00 degree direction.
LCC00T	Table ID defining for each temperature value a load curve ID giving the (quasi-static) compressive yield stress as a function of strain for that temperature. The curves in this table define compressive yield stress as a function of plastic strain in the 00 degree direction.
LCS45R	Table ID. The load curves define shear yield stress in function of plastic strain. The table ID defines for each plastic strain rate value a load curve ID giving the (isothermal) shear yield stress as a function of plastic strain for that rate in the 45 degree direction.
LCS45T	Table ID defining for each temperature value a load curve ID giving the (quasi-static) shear yield stress versus strain for that temperature. The load curves define shear yield stress as a function of plastic strain or effective plastic strain (see IFLAG) in the 45 degree direction.
IFLAG	Flag to specify abscissa for LCT00R, LCC00R, LCS45R, LCT90R, LCT45R, LCTTHR, LCC90R, LCC45R, LCCTHR: EQ.0: Compressive and shear yields are given as functions of plastic strain as defined in the remarks (default). EQ.1: Compressive and shear yields are given as functions of effective plastic strain.
SFIEPM	Scale factor on the initial estimate of the plastic multiplier
NITER	Maximum number of iterations for the plasticity algorithm

VARIABLE	DESCRIPTION
AOPT	<p>Material axes option (see MAT_OPTIONTROPIC_ELASTIC, particularly the Material Directions section, for details):</p> <p>EQ.0.0: Locally orthotropic with material axes determined by element nodes 1, 2, and 4, as with *DEFINE_COORDINATE_NODES.</p> <p>EQ.1.0: Locally orthotropic with material axes determined by a point, P, in space and the global location of the element center; this is the \mathbf{a}-direction. .</p> <p>EQ.2.0: Globally orthotropic with material axes determined by vectors defined below, as with *DEFINE_COORDINATE_VECTOR</p> <p>EQ.3.0: Locally orthotropic material axes determined by a vector \mathbf{v} and the normal vector to the plane of the element. The plane of a solid element is the midsurface between the inner surface and outer surface defined by the first four nodes and the last four nodes of the connectivity of the element, respectively. Thus, AOPT = 3 is only available for hexahedrons. \mathbf{a} is determined by taking the cross product of \mathbf{v} with the normal vector, \mathbf{b} is determined by taking the cross product of the normal vector with \mathbf{a}, and \mathbf{c} is the normal vector. Then \mathbf{a} and \mathbf{b} are rotated about \mathbf{c} by an angle. The angle may be set in the keyword input for the element or in the input for this keyword (see MANGLE). Note that the material axes may be switched depending on the choice of MACF. The switch may occur before or after applying the angle depending on the value of MACF.</p> <p>EQ.4.0: Locally orthotropic in a cylindrical coordinate system with the material axes determined by a vector \mathbf{v}, and an originating point, P, which define the centerline axis.</p> <p>LT.0.0: The absolute value of AOPT is a coordinate system ID number (CID on *DEFINE_COORDINATE_OPTION).</p>

Card 4	1	2	3	4	5	6	7	8
Variable	LCT90R	LCT45R	LCTTHR	LCC90R	LCC45R	LCCTHR		
Type	I	I	I	I	I	I		
Default	0	0	0	0	0	0		

VARIABLE**DESCRIPTION**

LCT90R	Table ID defining for each plastic strain rate value a load curve ID giving the (isothermal) tensile yield stress as a function of plastic strain for that rate in the 90 degree direction
LCT45R	Table ID defining for each plastic strain rate value a load curve ID giving the (isothermal) tensile yield stress as a function of plastic strain for that rate in the 45 degree direction
LCTTHR	Table ID defining for each plastic strain rate value a load curve ID giving the (isothermal) tensile yield stress as a function of plastic strain for that rate in the thickness degree direction
LCC90R	Table ID defining for each plastic strain rate value a load curve ID giving the (isothermal) compressive yield stress as a function of plastic strain for that rate in the 90 degree direction
LCC45R	Table ID defining for each plastic strain rate value a load curve ID giving the (isothermal) compressive yield stress as a function of plastic strain for that rate in the 45 degree direction
LCCTHR	Table ID defining for each plastic strain rate value a load curve ID giving the (isothermal) compressive yield stress as a function of plastic strain for that rate in the thickness degree direction

Card 5	1	2	3	4	5	6	7	8
Variable	LCT90T	LCT45T	LCTTHT	LCC90T	LCC45T	LCCTHT		
Type	I	I	I	I	I	I		
Default	0	0	0	0	0	0		

VARIABLE	DESCRIPTION
LCT90T	Table ID defining for each temperature value a load curve ID giving the (quasistatic) tensile yield stress as a function of plastic strain for that rate in the 90 degree direction
LCT45T	Table ID defining for each temperature value a load curve ID giving the (quasistatic) tensile yield stress as a function of plastic strain for that rate in the 45 degree direction
LCTTHT	Table ID defining for each temperature value a load curve ID giving the (quasistatic) tensile yield stress as a function of plastic strain for that rate in the thickness degree direction
LCC90T	Table ID defining for each temperature value a load curve ID giving the (quasistatic) compressive yield stress as a function of plastic strain for that rate in the 90 degree direction
LCC45T	Table ID defining for each temperature value a load curve ID giving the (quasistatic) compressive yield stress as a function of plastic strain for that rate in the 45 degree direction
LCCTHT	Table ID defining for each temperature value a load curve ID giving the (quasistatic) compressive yield stress as a function of plastic strain for that rate in the thickness degree direction

Card 6	1	2	3	4	5	6	7	8
Variable	XP	YP	ZP	A1	A2	A3	MACF	
Type	F	F	F	F	F	F	F	

VARIABLE	DESCRIPTION
XP, YP, ZP	Coordinates of point P for AOPT = 1 and 4
A1, A2, A3	Components of vector \mathbf{a} for AOPT = 2
MACF	Material axes change flag for solid elements: EQ.-4: Switch material axes b and c before BETA or MANGLE rotation

VARIABLE**DESCRIPTION**

EQ.-3: Switch material axes a and c before BETA or MANGLE rotation

EQ.-2: Switch material axes a and b before BETA or MANGLE rotation

EQ.1: No change, default

EQ.2: Switch material axes a and b after BETA or MANGLE rotation

EQ.3: Switch material axes a and c after BETA or MANGLE rotation

EQ.4: Switch material axes b and c after BETA or MANGLE rotation

Figure M2-2 indicates when LS-DYNA applies MACF during the process to obtain the final material axes. If BETA on *ELEMENT_SOLID_{OPTION} is defined, then BETA is used for the rotation for all AOPT options. Otherwise, for AOPT = 3, MANGLE input on Card 7 rotates the axes. For all other values of AOPT, the material axes will be switched as specified by MACF, but no rotation will be performed.

Card 7	1	2	3	4	5	6	7	8
Variable	V1	V2	V3	D1	D2	D3	MANGLE	
Type	F	F	F	F	F	F	F	

VARIABLE**DESCRIPTION**

V1, V2, V3

Components of vector \mathbf{v} for AOPT = 3

D1, D2, D3

Components of vector \mathbf{d} for AOPT = 2

MANGLE

Material angle in degrees for AOPT = 3. It may be overridden on the element card; see *ELEMENT_SOLID_ORTHO.

Remarks:

If IFLAG = 0 the compressive and shear curves are defined as follows:

$$\sigma_{\text{comp}}(\varepsilon_{p,\text{comp}}, \dot{\varepsilon}_{p,\text{comp}}), \quad \varepsilon_{p,\text{comp}} = \varepsilon_{\text{comp}} - \frac{\sigma_{\text{comp}}}{E}, \quad \dot{\varepsilon}_{p,\text{comp}} = \frac{\partial \varepsilon_{p,\text{comp}}}{\partial t}$$

where comp is one of the tension (0°,45°,90°), compression (0°,45°,90°), tension and compression thickness or shear components.

If IFLAG = 1, the compressive and shear curves are defined as follows:

$$\sigma_{\text{comp}}(\dot{\lambda}, \lambda) \quad \dot{W}_p = \sigma_{\text{eff}} \dot{\lambda}$$

History variables may be post-processed through additional variables. The number of additional variables for solids written to the d3plot and d3thdt databases is input by the optional *DATABASE_EXTENT_BINARY card as variable NEIPH. The relevant additional variables of this material model are tabulated below:

LS-PrePost History Variable #	Description
5	Strain Rate
6	Plastic failure strain
7	Triaxiality
8	Lode parameter
9	Plastic work
10	Damage
11	Element size
12	Temperature
13	Compressive plastic strain
14	Shear plastic strain

***MAT_CONSTRAINED_OPTION**

This is Material Type 265. This special model defines material data for *CONSTRAINED_SPR2 or *CONSTRAINED_INTERPOLATION_SPOTWELD (aka SPR3) instead of in the input for the constraint. This material model is not available for standard elements. See the [Sample Input](#) below.

Available options include:

SPR2

SPR3

The input depends on the option used, that is, SPR2 consist of two cards and SPR3 needs up to four cards.

Card Summary:

Card 1. This card is included if the keyword option SPR2 is used.

MID	RO	FN	FT	DN	DT	XIN	XIT
-----	----	----	----	----	----	-----	-----

Card 2. This card is included if the keyword option SPR2 is used.

ALPHA1	ALPHA2	ALPHA3	EXPN	EXPT			
--------	--------	--------	------	------	--	--	--

Card 3. This card is included if the keyword option SPR3 is used.

MID	RO	MODEL					
-----	----	-------	--	--	--	--	--

Card 4. This card is included if the keyword option SPR3 is used.

STIFF	RN	RS	ALPHA1	BETA1	LCF	LCUPF	LCUPR
-------	----	----	--------	-------	-----	-------	-------

Card 5a. This card is only read if the keyword option SPR3 is used and MODEL = 1, 11, or 21. It is optional.

STIFF2	STIFF3	STIFF4	LCDEXP	GAMMA	SROPT		
--------	--------	--------	--------	-------	-------	--	--

Card 5b.1. This card is only read if the keyword option SPR3 is used and MODEL = 2, 12, or 22. It is optional.

UPFN	UPFS	ALPHA2	BETA2	UPRN	UPRS	ALPHA3	BETA3
------	------	--------	-------	------	------	--------	-------

Card 5b.2. This card is read if the keyword option SPR3 is used and MODEL = 2, 12, or 22. It is optional.

MRN	MRS						
-----	-----	--	--	--	--	--	--

Data Card Definitions:

SPR2 cards. This card is included if the SPR2 keyword option is used.

Card 1	1	2	3	4	5	6	7	8
Variable	MID	RO	FN	FT	DN	DT	XIN	XIT
Type	A	F	F	F	F	F	F	F

VARIABLE

DESCRIPTION

MID	Material identification. A unique number or label must be specified (see *PART).
RO	Mass density
FN	Rivet strength in tension (pull-out)
FT	Rivet strength in pure shear
DN	Failure displacement in normal direction
DT	Failure displacement in tangential direction
XIN	Fraction of failure displacement at maximum normal force
XIT	Fraction of failure displacement at maximum tangential force

SPR2 cards. This card is included if the SPR2 keyword option is used.

Card 2	1	2	3	4	5	6	7	8
Variable	ALPHA1	ALPHA2	ALPHA3	EXPN	EXPT			
Type	F	F	F	F	F			

VARIABLE	DESCRIPTION
ALPHA1	Dimensionless parameter scaling the effective displacement
ALPHA2	Dimensionless parameter scaling the effective displacement
ALPHA3	Dimensionless parameter scaling the effective displacement. The sign of ALPHA3 can be used to choose the normal update procedure: GT.0: Incremental update (default) LT.0: Total update (recommended)
EXPN	Exponent value for load function in normal direction.
EXPT	Exponent value for load function in tangential direction.

SPR3 cards. This card is included if the SPR3 keyword option is used.

Card 3	1	2	3	4	5	6	7	8
Variable	MID	RO	MODEL					
Type	A	F	F					

VARIABLE	DESCRIPTION
MID	Material identification. A unique number or label must be specified (see *PART).
RO	Mass density
MODEL	Material behavior and damage model (see Remarks of *CONSTRAINED_INTERPOLATION_SPOTWELD). EQ.1: SPR3 (default) EQ.2: SPR4 EQ.11: Same as 1 with selected material parameters as functions EQ.12: Same as 2 with selected material parameters as functions EQ.21: Same as 11 with slight modification EQ.22: Same as 12 with slight modification

SPR3 cards. This card is included if the SPR3 keyword option is used.

Card 4	1	2	3	4	5	6	7	8
Variable	STIFF	RN	RS	ALPHA1	BETA1	LCF	LCUPF	LCUPR
Type	F	F	F	F	F	F	F	F

VARIABLE**DESCRIPTION**

STIFF

Elastic stiffness. Function ID if MODEL > 10 .

RN

Tensile strength factor, R_n .

GT.0.0: Constant value unless MODEL > 10. Function ID if MODEL > 10 (see Remarks section for *CONSTRAINED_INTERPOLATION_SPOTWELD).

LT.0.0: Load curve with ID |RN| giving R_n as a function of peel ratio (see Remarks section for *CONSTRAINED_INTERPOLATION_SPOTWELD)

RS

Shear strength factor, R_s . Function ID if MODEL > 10.

ALPHA1

Scaling factor α_1 . Function ID if MODEL > 10.

BETA1

Exponent for plastic potential β_1 . Function ID if MODEL > 10.

LCF

Load curve or table ID. Load curve ID describing force as a function of plastic displacement, that is, $F^0(\bar{u}^{pl})$. Table ID describing force as a function of mode mixity (table values) and plastic displacement (curves), that is, $F^0(\bar{u}^{pl}, \kappa)$.

LCUPF

Load curve ID describing plastic initiation displacement as a function of mode mixity, that is, $\bar{u}_0^{pl}(\kappa)$. Only for MODEL = 1, 11, or 21. For MODEL = 1, LCUPF can also be a table ID giving plastic initiation displacement as a function of peel ratio (table values) and mode mixity (curves). See Remarks section for *CONSTRAINED_INTERPOLATION_SPOTWELD.

VARIABLE	DESCRIPTION
LCUPR	Load curve ID describing plastic rupture displacement as a function of mode mixity, that is, $\bar{u}_f^{pl}(\kappa)$. Only for MODEL = 1, 11, or 21. For MODEL = 1, LCUPF can also be a table ID giving plastic initiation displacement as a function of peel ratio (table values) and mode mixity (curves). See Remarks section for *CONSTRAINED_INTERPOLATION_SPOTWELD.

SPR3 Optional Cards. This card is only read if the keyword option SPR3 is used and MODEL = 1, 11, or 21.

Card 5a	1	2	3	4	5	6	7	8
Variable	STIFF2	STIFF3	STIFF4	LCDEXP	GAMMA	SROPT		
Type	F	F	F	F	F	F		

VARIABLE	DESCRIPTION
STIFF2	Elastic shear stiffness
STIFF3	Elastic bending stiffness
STIFF4	Elastic torsional stiffness
LCDEXP	Load curve for damage exponent as a function of mode mixity
GAMMA	Scaling factor, γ_1
SROPT	Shear rotation option that defines local kinematics system: EQ.0: Pure shear does not create normal component (default). EQ.1: Pure shear creates normal component.

SPR3 Optional Cards. This card is only read if the keyword option SPR3 is used and MODEL = 2, 12, or 22.

Card 5b.1	1	2	3	4	5	6	7	8
Variable	UPFN	UPFS	ALPHA2	BETA2	UPRN	UPRS	ALPHA3	BETA3
Type	F	F	F	F	F	F	F	F

VARIABLE	DESCRIPTION
UPFN	Plastic initiation displacement in normal direction, $\bar{u}_{0,\text{ref}}^{\text{pl},n}$
UPFS	Plastic initiation displacement in shear direction, $\bar{u}_{0,\text{ref}}^{\text{pl},s}$
ALPHA2	Plastic initiation displacement scaling factor, α_2
BETA2	Exponent for plastic initiation displacement, β_2
UPRN	Plastic rupture displacement in normal direction, $\bar{u}_{f,\text{ref}}^{\text{pl},n}$
UPRS	Plastic rupture displacement in shear direction, $\bar{u}_{f,\text{ref}}^{\text{pl},s}$
ALPHA3	Plastic rupture displacement scaling factor, α_3
BETA3	Exponent for plastic rupture displacement, β_3

SPR3 Optional Cards. This card is only read if the keyword option SPR3 is used and MODEL = 2, 12, or 22.

Card 5b.2	1	2	3	4	5	6	7	8
Variable	MRN	MRS						
Type	F	F						

VARIABLE	DESCRIPTION
MRN	Proportionality factor for dependency, m_{R_n}
MRS	Proportionality factor for dependency, m_{R_s}

Sample Input:

With this material model it is possible to replace the following input example

```
*CONSTRAINED_SPR2
$  UPID  LPID  NSID  THICK  D  FN  FT  DN
$   5    8    123   5.0   8.0  2.53  4.8  4.0
$  DT   XIN   XIT  ALPHA1  ALPHA2  ALPHA3  DENS  INTP
$   7.5  0.6   0.5   0.2   0.7   1.9   7.8e-6  1
$  EXPN  EXPT  PIDVB
$   8.0   8.0   999
$  XPID1  XPID2  XPID3  XPID4
$    20
```

with this "split" one

```
*CONSTRAINED_SPR2
$   UPID      LPID      NSID      THICK      D      FN      FT      DN
    5         8        123       5.0       8.0    -555
$   DT        XIN       XIT      ALPHA1     ALPHA2  ALPHA3  DENS    INTP
                                1
$   EXPN      EXPT      PIDVB
                                999
$   XPID1     XPID2     XPID3     XPID4
    20
*MAT_CONSTRAINED_SPR2
$   MID      RO        FN      FT      DN      DT      XIN      XIT
    555     7.8e-6    2.53    4.8    4.0    7.5    0.6    0.5
$   ALPHA1   ALPHA2   ALPHA3   EXPN    EXPT
    0.2     0.7     1.9     8.0    8.0
```

and still get the same result. One can see that only the non-material data (MID, SID, NSID, THICK, D, INTP, PIDVB, XPID*i*) remains with the *CONSTRAINED keyword. Variables in grey are optional.

*MAT_TISSUE_DISPERSED

This is Material Type 266. This material is an invariant formulation for dispersed orthotropy in soft tissues, e.g., heart valves, arterial walls or other tissues where one or two collagen fibers are used. The passive contribution is composed of an isotropic and two anisotropic parts. The isotropic part is a simple neo-Hookean model. The first anisotropic part is passive, with two collagen fibers to choose from: (1) a simple exponential model and (2) a more advanced crimped fiber model from Freed et al. [2005]. The second anisotropic part is active described in Guccione et al. [1993] and is used for active contraction.

NOTE: This material model is obsolete. Please use MAT_ANISOTROPIC_HYPERELASTIC which contains most of the features of MAT_TISSUE_DISPERSED. For missing or additional features, please consult LST directly.

Card 1	1	2	3	4	5	6	7	8
Variable	MID	RO	F	SIGMA	MU	KAPPA	ACT	INIT
Type	A	F	F	F	F	F	I	I

Card 2	1	2	3	4	5	6	7	8
Variable	FID	ORTH	C1	C2	C3	THETA	NHMOD	
Type	I	I	F	F	F	F	F	

Card 3	1	2	3	4	5	6	7	8
Variable	ACT1	ACT2	ACT3	ACT4	ACT5	ACT6	ACT7	ACT8
Type	F	F	F	F	F	F	F	F

Card 4	1	2	3	4	5	6	7	8
Variable	ACT9	ACT10						
Type	F	F						

Card 5	1	2	3	4	5	6	7	8
Variable	AOPT	BETA	XP	YP	ZP	A1	A2	A3
Type	I	F	F	F	F	F	F	F

Card 6	1	2	3	4	5	6	7	8
Variable	V1	V2	V3	D1	D2	D3		
Type	F	F	F	F	F	F		

VARIABLE**DESCRIPTION**

MID	Material identification. A unique number or label must be specified (see *PART).
RO	Mass density.
F	Fiber dispersion parameter governs the extent to which the fiber dispersion extends to the third dimension. $F = 0$ and $F = 1$ apply to 2D splay with the normal to the membrane being in the β and the γ -directions, respectively (see Figure M266-1). $F = 0.5$ applies to 3D splay with transverse isotropy. Splay will be orthotropic whenever $F \neq 0.5$. This parameter is ignored if $INIT = 1$.
SIGMA	The parameter SIGMA governs the extent of dispersion, such that as SIGMA goes to zero, the material symmetry reduces to pure transverse isotropy. Conversely, as SIGMA becomes large, the material symmetry becomes isotropic in the plane. This parameter is ignored if $INIT = 1$.

VARIABLE	DESCRIPTION
MU	<p>MU is the isotropic shear modulus that models elastin. MU should be chosen such that the following relation is satisfied:</p> $0.5 (3KAPPA - 2MU) / (3KAPPA + MU) < 0.5.$ <p>Instability can occur for implicit simulations if this quotient is close to 0.5. A modest approach is a quotient between 0.495 and 0.497.</p>
KAPPA	Bulk modulus for the hydrostatic pressure.
ACT	ACT = 1 indicates that an active model will be used that acts in the mean fiber-direction. The active model, like the passive model, will be dispersed by SIGMA and F, or if INIT = 1, with the *INITIAL_FIELD_SOLID keyword.
INIT	INIT = 1 indicates that the anisotropy eigenvalues will be given by *INITIAL_FIELD_SOLID variables in the global coordinate system (see Remark 1).
FID	The passive fiber model number. There are two passive models available: FID = 1 or FID = 2. They are described in Remark 2.
ORTH	ORTH specifies the number (1 or 2) of fibers used. When ORTH = 2 two fiber families are used and arranges symmetrically THETA degrees from the mean fiber direction and lying in the tissue plane.
C1-C3	Passive fiber model parameters.
THETA	The angle between the mean fiber direction and the fiber families. The parameter is active only if ORTH = 2 and is particularly important in vascular tissues (e.g. arteries)
NHMOD	<p>Neo-Hooke model flag</p> <p>EQ.0.0: Original implementation (modified Neo-Hooke)</p> <p>EQ.1.0: Standard Neo-Hooke model (as in umat45 of dyn21.f)</p>
ACT1 - ACT10	Active fiber model parameters. Note that ACT10 is an input for a time dependent load curve that overrides some of the ACTx values. See section 2 below.
AOPT	Material axes option (see MAT_OPTIONTROPIC_ELASTIC for a more complete description):

VARIABLE	DESCRIPTION
	EQ.0.0: Locally orthotropic with material axes determined by element nodes 1, 2, and 4, as with *DEFINE_COORDINATE_NODES.
	EQ.1.0: Locally orthotropic with material axes determined by a point in space and the global location of the element center; this is the a -direction.
	EQ.2.0: Globally orthotropic with material axes determined by vectors defined below, as with *DEFINE_COORDINATE_VECTOR.
	EQ.3.0: Locally orthotropic material axes determined by rotating the material axes about the element normal by an angle, BETA, from a line in the plane of the element defined by the cross product of the vector \mathbf{v} with the element normal.
	EQ.4.0: Locally orthotropic in cylindrical coordinate system with the material axes determined by a vector \mathbf{v} , and an originating point, \mathbf{p} , which define the centerline axis.
	LT.0.0: The absolute value of AOPT is a coordinate system ID number (CID on *DEFINE_COORDINATE_NODES, *DEFINE_COORDINATE_SYSTEM or *DEFINE_COORDINATE_VECTOR).
BETA	Material angle in degrees for AOPT = 3, may be overridden on the element card *ELEMANT_SOLID_ORTHO.
XP - ZP	XP, YP and ZP define the coordinates of point P for AOPT = 1 and AOPT = 4.
A1 - A3	A1, A2 and A3 define the components of vector A for AOPT = 2.
D1 - D3	D1, D2 and D3 define components of vector D for AOPT = 2.
V1 - V3	V1, V2 and V3 define components of vector V for AOPT = 3 and AOPT = 4.

Material Formulation:

Details of the passive model can be found in Freed et al. (2005) and Einstein et al. (2005). The stress in the reference configuration consists of a deviatoric matrix term, a hydrostatic pressure term, and either one (ORTHO = 1) or two (ORTH = 2) fiber terms:

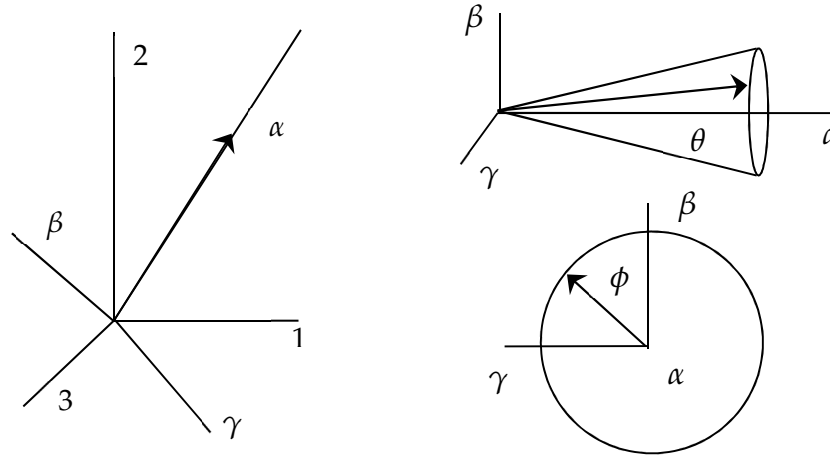

Figure M266-1. The plot on the left relates the global coordinates (1, 2, 3) to the local coordinates (α, β, γ) , selected so the mean fiber direction in the reference configuration is align with the α -axis. The plots on the right show how the unit vector for a specific fiber within the fiber distribution of a 3D tissue is oriented with respect to the mean fiber direction via angles θ and ϕ .

$$\mathbf{S} = \kappa J(J - 1)\mathbf{C}^{-1} + \mu J^{-2/3} \mathbf{DEV} \left[\frac{1}{4} (\mathbf{I} - \bar{\mathbf{C}}^{-2}) \right] + J^{-2/3} \sum_{i=1}^n [\sigma_i(\lambda_i) + \varepsilon_i(\lambda_i)] \mathbf{DEV}[\mathbf{K}_i]$$

where \mathbf{S} is the second Piola-Kirchhoff stress tensor, J is the Jacobian of the deformation gradient, κ is the bulk modulus, σ_i is the passive fiber stress model used, and ε_i is the corresponding active fiber model used. The operator \mathbf{DEV} is the deviatoric projection:

$$\mathbf{DEV}[\bullet] = (\bullet) - \frac{1}{3} \text{tr}[(\bullet)\mathbf{C}]\mathbf{C}^{-1}$$

where \mathbf{C} is the right Cauchy-Green deformation tensor. The dispersed fourth invariant $\lambda = \sqrt{\text{tr}[\mathbf{K}\bar{\mathbf{C}}]}$, where $\bar{\mathbf{C}}$ is the isochoric part of the Cauchy-Green deformation. Note that λ is not a stretch in the classical way, since \mathbf{K} embeds the concept of dispersion. \mathbf{K} is called the dispersion tensor or anisotropy tensor and is given in global coordinates. The passive and active fiber models are defined in the fiber coordinate system. In effect the dispersion tensor rotates and weights these one dimensional models, such that they are both three-dimensional and in the Cartesian framework.

In the case where, the splay parameters SIGMA and F are specified, \mathbf{K} is given by:

$$\mathbf{K}_i = \frac{1}{2} \mathbf{Q}_i \begin{bmatrix} 1 + e^{-2\text{SIGMA}^2} & 0 & 0 \\ 0 & F(1 - e^{-2\text{SIGMA}^2}) & 0 \\ 0 & 0 & (1 - F)(1 - e^{-2\text{SIGMA}^2}) \end{bmatrix} \mathbf{Q}_i^T$$

where \mathbf{Q} is the transformation tensor that rotates from the local to the global Cartesian system. In the case when INIT = 1, the dispersion tensor is given by

$$\mathbf{K}_i = \mathbf{Q}_i \begin{pmatrix} \chi_i^1 & 0 & 0 \\ 0 & \chi_i^2 & 0 \\ 0 & 0 & \chi_i^3 \end{pmatrix} \mathbf{Q}_i^T$$

where the χ :s are given on the *INITIAL_FIELD_SOLID card. For the values to be physically meaningful $\chi_i^1 + \chi_i^2 + \chi_i^3 = 1$. It is the responsibility of the user to assure that this condition is met, no internal checking for this is done. These values typically come from diffusion tensor data taken from the myocardium.

Remarks:

1. Passive fiber models. Currently there are two models available.
 - a) If FID = 1 a crimped fiber model is used. It is solely developed for collagen fibers. Given H_0 and R_0 compute:

$$L_0 = \sqrt{(2\pi)^2 + (H_0)^2}, \Lambda = \frac{L_0}{H_0}$$

and

$$E_s = \frac{E_f H_0}{H_0 + \left(1 + \frac{37}{6\pi^2} + 2\frac{L_0^2}{\pi^2}\right) (L_0 - H_0)}$$

Now if the fiber stretches $\lambda < \Lambda$ the fiber stress is given by:

$$\sigma = \xi E_s (\lambda - 1)$$

where

$$\xi = \frac{6\pi^2(\Lambda^2 + (4\pi^2 - 1)\lambda^2)\lambda}{\Lambda(3H_0^2(\Lambda^2 - \lambda^2)(3\Lambda^2 + (8\pi^2 - 3)\lambda^2) + 8\pi^2(10\Lambda^2 + (3\pi^2 - 10)\lambda^2))}$$

and if $\lambda > \Lambda$ the fiber stress equals:

$$\sigma = E_s(\lambda - 1) + E_f(\lambda - \Lambda).$$

In [Figure M266-1](#) the fiber stress is rendered with $H_0 = 27.5, R_0 = 2$ and the transition point becomes $\Lambda = 1.1$.

- b) The second fiber model available (FID = 2) is a simpler but more useful model for the general fiber reinforced rubber. The fiber stress is simply given by:

$$\sigma = C_1 \left[e^{\frac{C_2}{2}(\lambda^2 - 1)} - 1 \right].$$

The difference between the two fiber models is given in [Figure M266-2](#).

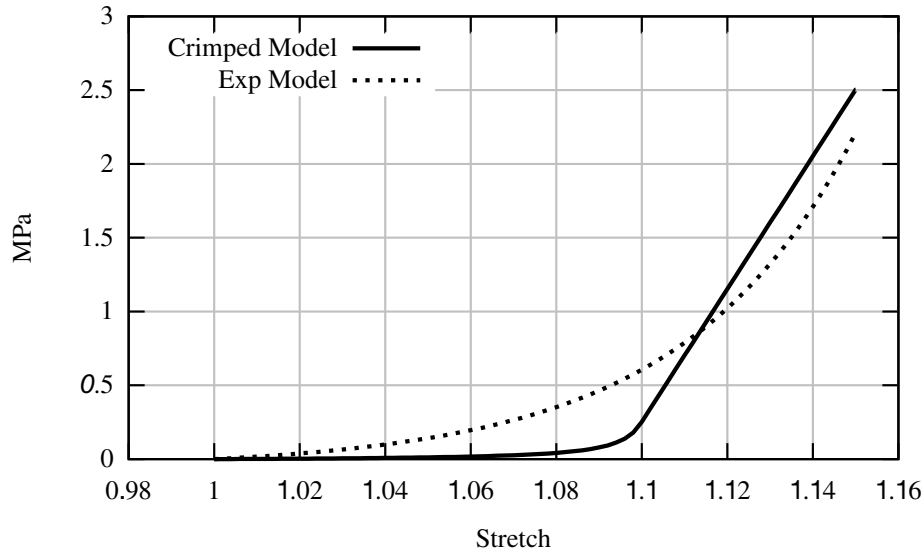

Figure M266-2. both the Crimped and the Exponential fiber models visualized. Here $\Lambda = 1.1$ is the transition point in the crimped model.

The active model for myofibers ($ACT = 1$) is defined in Guccione et al. (1993) and is given by:

$$\sigma = T_{\max} \frac{Ca_0^2}{Ca_0^2 + ECa_{50}^2} C(t)$$

where

$$ECa_{50}^2 = \frac{(Ca_0)_{\max}}{\sqrt{e^{B(l_r\sqrt{2(\lambda-1)+1}-l_0)}-1}}$$

and B is a constant, $(Ca_0)_{\max}$ is the maximum peak intracellular calcium concentration, l_0 is the sarcomere length at which no active tension develops and l_r is the stress free sarcomere length. The function $C(t)$ is defined in one of two ways. First it can be given as:

$$C(t) = \frac{1}{2} (1 - \cos\omega(t))$$

where

$$\omega = \begin{cases} \pi \frac{t}{t_0} & 0 \leq t < t_0 \\ \pi \frac{t - t_0 + t_r}{t_r} & t_0 \leq t < t_0 + t_r \\ 0 & t_0 + t_r \leq t \end{cases}$$

and $t_r = ml_R\lambda + b$. Secondly, it can also be given as a load curve. If a load curve should be used its index must be given in ACT10. Note that all variables that

correspond to ω are neglected if a load curve is used. The active parameters on Card 3 and 4 are interpreted as:

ACT1	ACT2	ACT3	ACT4	ACT5	ACT6	ACT7	ACT8	ACT9	ACT10
T_{\max}	Ca_0	$(Ca_0)_{\max}$	B	l_0	t_0	m	b	l_R	LCID

References:

1. Freed AD., Einstein DR. and Vesely I., Invariant formulation for dispersed transverse isotropy in aortic heart valves – An efficient means for modeling fiber splay, Biomechan model Mechanobiol, 4, 100-117, 2005.
2. Guccione JM., Waldman LK., McCulloch AD., Mechanics of Active Contraction in Cardiac Muscle: Part II – Cylindrical Models of the Systolic Left Ventricle, J. Bio Mech, 115, 82-90, 1993.

*MAT_EIGHT_CHAIN_RUBBER

This is Material Type 267. This is an advanced rubber-like model that is tailored for glassy polymers and similar materials. It is based on Arruda’s eight chain model but enhanced with non-elastic properties. This material is available for solid and SPH elements.

Card Summary:

Card 1. This card is required.

MID	RO	K	MU	N	MULL	VISPL	VISEL
-----	----	---	----	---	------	-------	-------

Card 2. This card is required.

YLD0	FP	GP	HP	LP	MP	NP	PMU
------	----	----	----	----	----	----	-----

Card 3. This card is required.

M1	M2	M3	M4	M5	TIME	VCON	
----	----	----	----	----	------	------	--

Card 4. This card is required.

Q1	B1	Q2	B2	Q3	B3	Q4	B4
----	----	----	----	----	----	----	----

Card 5. This card is required.

K1	S1	K2	S2	K3	S3		
----	----	----	----	----	----	--	--

Card 6. This card is required.

AOPT	MACF	XP	YP	ZP	A1	A2	A3
------	------	----	----	----	----	----	----

Card 7. This card is required.

V1	V2	V3	D1	D2	D3	BETA	
----	----	----	----	----	----	------	--

Card 8a. This card is included if VISEL = 1. Include up to 6 of this card. This next keyword (“*”) card terminates this input.

TAU _i	BETA _i						
------------------	-------------------	--	--	--	--	--	--

Card 8b. This card is included if VISEL = 2. Include up to 6 of this card. The next keyword (“*”) card terminates this input.

TAU _i	GAMMA _i						
------------------	--------------------	--	--	--	--	--	--

Data Card Definitions:

Card 1	1	2	3	4	5	6	7	8
Variable	MID	RO	K	MU	N	MULL	VISPL	VISEL
Type	A	F	F	F	I	I	I	I
Default	none	none	0.0	0.0	0	none	0	0

VARIABLE**DESCRIPTION**

MID Material identification. A unique number or label must be specified (see *PART).

RO Mass density

K Bulk modulus. To get almost incompressible behavior set K one or two orders of magnitude higher than MU. Note that the Poisson's ratio should be kept at a realistic value.

$$\nu = \frac{3K - 2MU}{2(3K + MU)}$$

MU Shear modulus. MU is the product of the number of molecular chains per unit volume (n), Boltzmann's constant (k) and the absolute temperature (T). Thus $MU = nkT$.

N Number of rigid links between crosslinks of the soft domain region. See [Remark 1](#).

MULL Parameter describing which softening algorithm that shall be used (see [Remarks 1](#) and [2](#)).

EQ.1: Strain based Mullins effect from Qi and Boyce

EQ.2: Energy based Mullins, a modified version of Roxburgh and Ogden model. M1, M2, and M3 must be set.

VISPL Parameter describing which viscoplastic formulation that should be used; see the theory section for details (see [Remark 4](#)).

EQ.0: No viscoplasticity

EQ.1: 2 parameter standard model; K1 and S1 must be set.

VARIABLE	DESCRIPTION
	EQ.2: 6 parameter G'Sells model; K1, K2, K3, S1, S2 and S3 must be set.
	EQ.3: 4 parameter strain hardening model; K1, K2, S1, and S2 must be set.
VISEL	Option for viscoelastic behavior; see the theory section for details. EQ.0: No viscoelasticity EQ.1: Free energy formulation based on Holzapfel and Ogden EQ.2: Formulation based on stiffness ratios from Simo et al.

Card 2	1	2	3	4	5	6	7	8
Variable	YLD0	FP	GP	HP	LP	MP	NP	PMU
Type	F	F	F	F	F	F	F	F
Default	0.0	0.0	0.0	0.0	0.0	0.0	0.0	0.0

VARIABLE	DESCRIPTION
YLD0	Initial yield stress (see Remark 4). EQ.0.0: No plasticity GT.0.0: Initial yield stress; hardening is defined separately. LT.0.0: -YLD0 is taken as the load curve ID for the yield stress as a function of effective plastic strain.
FP-NP	Parameters for Hill's general yield surface. For Von Mises yield criteria set FP = GP = HP = 0.5 and LP = MP = NP = 1.5. See Remark 4 .
PMU	Kinematic hardening parameter. It usually equals MU. See Remark 5 .

Card 3	1	2	3	4	5	6	7	8
Variable	M1	M2	M3	M4	M5	TIME	VCON	
Type	F	F	F	F	F	F	F	
Default	none	none	none	none	none	0.0	9.0	

VARIABLE**DESCRIPTION**

M1	<p>Mullins constant (see Remarks 1 and 2):</p> <p>MULL.EQ.1: Constant A. For the case of a dilute solution the Mullins parameter A should be equal to 3.5. See Qi and Boyce [2004].</p> <p>MULL.EQ.2: Constant M1 in the Mullins equations. $M1 > 0.0$ must be set.</p>
M2	<p>Mullins constant (see Remarks 1 and 2):</p> <p>MULL.EQ.1: Constant B. For a system with well dispersed particles B should somewhere around 18. See Qi and Boyce [2004].</p> <p>MULL.EQ.2: Constant M2 in the Mullins equations. $M2 > 0.0$ must be set.</p>
M3	<p>Mullins constant (see Remarks 1 and 2):</p> <p>MULL.EQ.1: Constant Z. Qi recommends 0.7.</p> <p>MULL.EQ.2: Constant M3 in the Mullins equations. $M3 > 0.0$ must be set.</p>
M4	<p>Mullins parameter (see Remarks 1 and 2):</p> <p>MULL.EQ.1: Initial value of v_s. v_s must be between 0 and 1 and must be less than v_{ss} (see M5).</p> <p>MULL.EQ.2: Not used</p>
M5	<p>Mullins parameter (see Remarks 1 and 2):</p> <p>MULL.EQ.1: v_{ss}, saturation value of v_s. v_{ss} must be between 0 and 1 and must be greater than v_s (see M4).</p> <p>MULL.EQ.2: Not used</p>

VARIABLE

DESCRIPTION

TIME

A time filter is used to smooth out the time derivative of the strain invariant over a TIME interval. Default is no smoothing but a value $100 \times \text{TIMESTEP}$ is recommended.

VCON

A material constant for the volumetric part of the strain energy. The default is 9.0 but any value can be used to tailor the volumetric response.

Card 4	1	2	3	4	5	6	7	8
Variable	Q1	B1	Q2	B2	Q3	B3	Q4	B4
Type	F	F	F	F	F	F	F	F
Default	0.0	0.0	0.0	0.0	0.0	0.0	0.0	0.0

VARIABLE

DESCRIPTION

Q1 - B4

Voce hardening parameters. See [Remark 4](#).

Card 5	1	2	3	4	5	6	7	8
Variable	K1	S1	K2	S2	K3	S3		
Type	F	F	F	F	F	F		
Default	0.0	0.0	0.0	0.0	0.0	0.0		

VARIABLE

DESCRIPTION

K1 - S3

Viscoplastic parameters (see [Remark 4](#)).

VISPL.EQ.1: K1 and S1 are used.

VISPL.EQ.2: K1, S1, K2, S2, K3 and S3 are used.

VISPL.EQ.3: K1, S1 and K2 are used.

Card 6	1	2	3	4	5	6	7	8
Variable	AOPT	MACF	XP	YP	ZP	A1	A2	A3
Type	F	F	F	F	F	F	F	F
Default	0.0	0.0	0.0	0.0	0.0	0.0	0.0	0.0

VARIABLE**DESCRIPTION**

AOPT

Material axes option (see *MAT_OPTIONTROPIC_ELASTIC*, particularly the [Material Directions](#) section, for details):

EQ.0.0: Locally orthotropic with material axes determined by element nodes 1, 2, and 4, as with *DEFINE_COORDINATE_NODES.

EQ.1.0: Locally orthotropic with material axes determined by a point, P , in space and the global location of the element center; this is the \mathbf{a} -direction. This option is for solid elements only.

EQ.2.0: Globally orthotropic with material axes determined by vectors defined below, as with *DEFINE_COORDINATE_VECTOR

EQ.3.0: Locally orthotropic material axes determined by a vector \mathbf{v} and the normal vector to the plane of the element. The plane of a solid element is the midsurface between the inner surface and outer surface defined by the first four nodes and the last four nodes of the connectivity of the element, respectively. Thus, for solid elements, AOPT = 3 is only available for hexahedrons. \mathbf{a} is determined by taking the cross product of \mathbf{v} with the normal vector, \mathbf{b} is determined by taking the cross product of the normal vector with \mathbf{a} , and \mathbf{c} is the normal vector. Then \mathbf{a} and \mathbf{b} are rotated about \mathbf{c} by an angle BETA. BETA may be set in the keyword input for the element or in the input for this keyword. Note that for solids, the material axes may be switched depending on the choice of MACF. The switch may occur before or after applying BETA depending on the value of MACF.

VARIABLE	DESCRIPTION
----------	-------------

EQ.4.0: Locally orthotropic in a cylindrical coordinate system with the material axes determined by a vector \mathbf{v} , and an originating point, P , which define the centerline axis. This option is for solid elements only.

MACF

Material axes change flag for solid elements:

- EQ.-4: Switch material axes b and c before BETA rotation
- EQ.-3: Switch material axes a and c before BETA rotation
- EQ.-2: Switch material axes a and b before BETA rotation
- EQ.1: No change, default
- EQ.2: Switch material axes a and b after BETA rotation
- EQ.3: Switch material axes a and c after BETA rotation
- EQ.4: Switch material axes b and c after BETA rotation

Figure M2-2 indicates when LS-DYNA applies MACF during the process to obtain the final material axes. If BETA on *ELEMENT_SOLID_{OPTION} is defined, then that BETA is used for the rotation for all AOPT options. Otherwise, if AOPT = 3, the BETA input on Card 7 rotates the axes. For all other values of AOPT, the material axes will be switched as specified by MACF, but no BETA rotation will be performed.

XP, YP, ZP

Coordinates for point p for AOPT = 1 and 4

A1, A2, A3

Components of vector \mathbf{a} for AOPT = 2

Card 7	1	2	3	4	5	6	7	8
Variable	V1	V2	V3	D1	D2	D3	BETA	
Type	F	F	F	F	F	F	F	
Default	0.0	0.0	0.0	0.0	0.0	0.0	0.0	

VARIABLE	DESCRIPTION
----------	-------------

D1, D2, D3

Components of vector \mathbf{d} for AOPT = 2

V1, V2, V3

Components of vector \mathbf{v} for AOPT = 3 and 4

VARIABLE

DESCRIPTION

BETA

Material angle in degrees for AOPT = 3. It may be overridden on the element card; see *ELEMENT_SOLID_ORTHO.

Card 8a	1	2	3	4	5	6	7	8
Variable	TAU _i	BETA _i						
Type	F	F						
Default	0.0	0.0						

VARIABLE

DESCRIPTION

TAU_i

Relaxation time. See [Remark 3](#).

BETA_i

Dissipating energy factors (see Holzapfel). See [Remark 3](#).

Card 8b	1	2	3	4	5	6	7	8
Variable	TAU _i	GAMMA _i						
Type	F	F						
Default	0.0	0.0						

VARIABLE

DESCRIPTION

TAU_i

Relaxation time. A maximum of 6 values can be used. See [Remark 3](#).

GAMMA_i

Gamma factors (see Simo). See [Remark 3](#).

Remarks:

- Basic Theory.** This model is based on the work done by Arruda and Boyce [1993], in particular Arruda’s thesis [1992]. The eight chain rubber model is based on hyper-elasticity. It is formulated with elastic strain invariants. Strain

softening is accounted for by the parameter from v_s following the work done by Qi and Boyce [2004].

The strain energy is defined in terms of the elastic deformation gradient \mathbf{F}_e through the right Cauchy-Green tensor $\mathbf{C}_e = \mathbf{F}_e^T \mathbf{F}_e$ and its determinant $J_e = \det \mathbf{F}_e$ as $\Psi = \Psi_1 + \Psi_2$. Ψ_1 and Ψ_2 are the deviatoric and volumetric contributions, respectively:

$$\Psi_1 = v_s \mu \left[\sqrt{N} \Lambda_c \beta + N \ln \left(\frac{\beta}{\sinh \beta} \right) \right]$$

$$\Psi_2 = \frac{\kappa}{\nu_{\text{con}}^2} \left(\nu_{\text{con}} \ln J_e + \frac{1}{J_e^{\nu_{\text{con}}}} - 1 \right)$$

Here

$$\beta = \mathcal{L}^{-1} \left(\frac{\Lambda_c}{\sqrt{N}} \right)$$

with \mathcal{L}^{-1} denoting the inverse of the Langevin function, $\mathcal{L}(x) = \coth x - 1/x$, and the amplified chain stretch is given by

$$\Lambda_c = \sqrt{X(v_s)(\bar{\lambda}^2 - 1) + 1},$$

where $\bar{\lambda}^2 = \text{Tr}(\bar{\mathbf{C}}_e)/3$ and $\bar{\mathbf{C}}_e = J_e^{-2/3} \mathbf{C}_e$.

Among the constant parameters, μ is the initial modulus of the soft domain, κ is the bulk modulus, ν_{con} is a pressure influential exponent and N is the number of rigid links between crosslinks of the soft domain region. X is a general polynomial describing the interaction between the soft and hard phases (Qi and Boyce [2004] and Tobin and Mullins [1957]). It is given by

$$X(v_s) = 1 + A(1 - v_s) + B(1 - v_s)^2$$

where A and B are constants. Without the Mullins effect, $v_s = 1$. Otherwise, its evolution depends on the Mullins effect. See [Remark 2](#).

The Cauchy stress is then computed as

$$\boldsymbol{\sigma} = \frac{2}{J_e} \mathbf{F}_e \frac{\partial \Psi}{\partial \mathbf{C}_e} \mathbf{F}_e^T = v_s \mu \frac{X(v_s) \sqrt{N}}{3 J_e^{5/3}} \frac{\beta}{\Lambda_c} \left(\mathbf{B}_e - \frac{\text{tr}(\mathbf{B}_e)}{3} \mathbf{I} \right) + \frac{\kappa}{\nu_{\text{con}} J_e} \left(1 - \frac{1}{J_e^{\nu_{\text{con}}}} \right) \mathbf{I},$$

where $\mathbf{B}_e = \mathbf{F}_e \mathbf{F}_e^T$ is the left elastic Cauchy-Green tensor.

2. **Mullins Effect.** Two models for the Mullins effect are implemented.

a) $MULL = 1$. The strain softening is developed by the evolution law taken from Boyce 2004:

$$\dot{v}_s = Z(v_{ss} - v_s) \frac{\sqrt{N} - 1}{(\sqrt{N} - \Lambda_c^{\max})^2} \dot{\Lambda}_c^{\max},$$

where Z is a parameter that characterizes the evolution in v_s with increasing $\dot{\Lambda}_c^{\max}$. The parameter v_{ss} is the saturation value of v_s . Note that $\dot{\Lambda}_c^{\max}$ is the maximum of Λ_c from the past:

$$\dot{\Lambda}_c^{\max} = \begin{cases} 0 & \Lambda_c < \Lambda_c^{\max} \\ \dot{\Lambda}_c & \Lambda_c > \Lambda_c^{\max} \end{cases}$$

The structure now evolves with the deformation. The dissipation inequality requires that the evolution of the structure is irreversible $\dot{v}_s \geq 0$. See Qi and Boyce [2004].

- b) *MULL* = 2. The energy driven model is based on Ogden and Roxburgh. When activated the strain energy is automatically transformed to a standard eight chain model, meaning the variables Z , v_s and X are automatically set to 0, 1, and 1, respectively. The stress is multiplicative split of the true stress and the softening factor η .

$$\bar{\sigma} = \eta\sigma, \quad \eta = 1 - \frac{1}{M1} \operatorname{erf} \left(\frac{\Psi_1^{\max} - \Psi_1}{M3 - M2\Psi_1^{\max}} \right).$$

3. **Viscoelasticity.** Two models for viscoelasticity are implemented.

- a) *VISEL* = 1. The viscoelasticity is based on work done by Holzapfel (2004)

$$\dot{\mathbf{Q}}_\alpha + \frac{\mathbf{Q}_\alpha}{\tau_\alpha} = 2\beta_\alpha \frac{d}{dt} \frac{\partial \Psi_1}{\partial \mathbf{C}_e} = \beta_\alpha \dot{\mathbf{S}}_1$$

where α is the number of viscoelastic terms (1, ..., 6).

- b) *VISEL* = 2. With this option the evolution is based on work done by Simo and Hughes (2000).

$$\dot{\mathbf{Q}}_\alpha + \frac{\mathbf{Q}_\alpha}{\tau_\alpha} = 2 \frac{\gamma_a}{\tau_a} \frac{d}{dt} \frac{\partial \Psi_1}{\partial \mathbf{C}_e} = \frac{\gamma_a}{\tau_a} \mathbf{S}_1$$

The number of Prony terms is restricted to a maximum of 6. Also τ_α and γ_α must be greater than 0. The Cauchy stress is obtained by a push forward operation on the total second Piola-Kirchhoff stress.

$$\boldsymbol{\sigma} = \frac{1}{J} \mathbf{F}_e \mathbf{S} \mathbf{F}_e^T.$$

4. **Viscoplasticity.** Plasticity is based on the general Hills' yield surface

$$\sigma_{eff}^2 = F(\sigma_{22} - \sigma_{33})^2 + G(\sigma_{33} - \sigma_{11})^2 + H(\sigma_{11} - \sigma_{22})^2 + 2L\sigma_{12}^2 + 2M\sigma_{23}^2 + 2N\sigma_{13}^2$$

The hardening is either based on a load curve ID (-YLD0) or an extended Voce hardening

$$\sigma_{\text{yld}} = \sigma_{\text{yld0}} + Q_1(1 - e^{B_1\bar{\epsilon}}) + Q_2(1 - e^{B_2\bar{\epsilon}}) + Q_3(1 - e^{B_3\bar{\epsilon}}) + Q_4(1 - e^{B_4\bar{\epsilon}}) .$$

The evolution of the elastic deformation gradient \mathbf{F}_e is written as

$$\dot{\mathbf{F}}_e = (\mathbf{L} - \mathbf{L}_p)\mathbf{F}_e$$

where \mathbf{L} is the spatial velocity gradient and \mathbf{L}_p is the spatial (Eulerian) plastic velocity gradient which is given by the associative flow rule

$$\mathbf{L}_p = \dot{\bar{\epsilon}} \frac{\partial f}{\partial \boldsymbol{\sigma}}$$

with f being the rate independent yield surface

$$f = \sigma_{\text{eff}} - \sigma_{\text{yld}} .$$

For rate independent plasticity ($\text{VISPL} = 0$) the evolution of plastic strain $\bar{\epsilon}$ follows from the consistency conditions $f \leq 0$, $\dot{\bar{\epsilon}} \geq 0$ and $f\dot{\bar{\epsilon}} = 0$. For viscoplasticity these conditions are abandoned, but we instead invoke a constitutive equation for the effective plastic strain rate. This is the Perzyna (1966) overstress model, and three different formulations are available.

a) $\text{VISPL} = 1$. The evolution equation is

$$\dot{\bar{\epsilon}} = \left(\frac{\max(f, 0)}{K_1} \right)^{S_1} ,$$

where K_1 and S_1 are viscoplastic material parameters.

b) $\text{VISPL} = 2$. The evolution equation is

$$\dot{\bar{\epsilon}} = \left[\frac{\max(f, 0)}{K_1(1 - e^{-S_1(\bar{\epsilon} + K_2)})e^{S_2\bar{\epsilon}K_3}} \right]^{S_3} ,$$

where K_1, K_2, K_3, S_1, S_2 , and S_3 are viscoplastic parameters.

c) $\text{VISPL} = 3$. The evolution equation is

$$\dot{\bar{\epsilon}} = \left(\frac{\max(f, 0)}{K_1} \right)^{S_1} (\bar{\epsilon} + K_2)^{S_2}$$

where K_1, K_2, S_1 , and S_2 are viscoplastic parameters.

5. **Kinematic Hardening.** The back stress is calculated similar to the Cauchy stress above but without the softening factors:

$$\boldsymbol{\beta} = \frac{\mu_p \sqrt{N}}{3J \Lambda_c} L^{-1} \left(\frac{\Lambda_c}{\sqrt{N}} \right) \left(\mathbf{I} - \frac{1}{3} I_p \mathbf{C}_p^{-1} \right) .$$

μ_p is a hardening material parameter (PMU). The total Piola-Kirchhoff stress is now given by $\mathbf{S}^* = \mathbf{S} - \beta$ and the total stress is given by a standard push forward operation with the elastic deformation gradient.

References:

Qi HJ., Boyce MC., Constitutive model for stretch-induced softening of stress-stretch behavior of elastomeric materials, *Journal of the Mechanics and Physics of Solids*, 52, 2187-2205, 2004.

Arrude EM., Characterization of the strain hardening response of amorphous polymers, PhD Thesis, MIT, 1992.

Mullins L., Tobin NR., Theoretical model for the elastic behavior of filler reinforced vulcanized rubber, *Rubber Chem. Technol.*, 30, 555-571, 1957.

Ogden RW. Roxburgh DG., A pseudo-elastic model for the Mullins effect in Filled rubber., *Proc. R. Soc. Lond. A.*, 455, 2861-2877, 1999.

Simo JC., Hughes TJR., *Computational Inelasticity*, Springer, New York, 2000.

Holzapfel GA., *Nonlinear Solid Mechanics*, Wiley, New-York, 2000.

***MAT_BERGSTROM_BOYCE_RUBBER**

This is material type 269. This is a rubber model based on the Arruda and Boyce (1993) chain model accompanied with a viscoelastic contribution according to Bergström and Boyce (1998). The viscoelastic treatment is based on the physical response of a single entangled chain in an embedded polymer gel matrix and the implementation is based on Dal and Kaliske (2009). This model is only available for solid elements.

Card 1	1	2	3	4	5	6	7	8
Variable	MID	RO	K	G	GV	N	NV	
Type	A8	F	F	F	F	F	F	
Default	none	none	none	none	none	none	none	

Card 2	1	2	3	4	5	6	7	8
Variable	C	M	GAMO	TAUH				
Type	F	F	F	F				
Default	none	none	none	none				

VARIABLE**DESCRIPTION**

MID	Material identification. A unique number or label not exceeding 8 characters must be specified.
RO	Mass density.
K	Elastic bulk modulus, K
G	Elastic shear modulus, G
GV	Viscoelastic shear modulus, G_v
N	Elastic segment number, N

VARIABLE	DESCRIPTION
NV	Viscoelastic segment number, N_v
C	Inelastic strain exponent, c , should be less than zero
M	Inelastic stress exponent, m
GAM0	Reference strain rate, $\dot{\gamma}_0$
TAUH	Reference Kirchhoff stress, $\hat{\tau}$

Remarks:

The deviatoric Kirchhoff stress for this model is the sum of an elastic and viscoelastic part according to

$$\bar{\boldsymbol{\tau}} = \boldsymbol{\tau}_e + \boldsymbol{\tau}_v$$

The elastic part is governed by the Arruda-Boyce strain energy potential resulting in the following expression (after a Pade approximation of the Langevin function)

$$\boldsymbol{\tau}_e = \frac{G}{3} \frac{3 - \lambda_r^2}{1 - \lambda_r^2} \left(\bar{\mathbf{b}} - \frac{Tr(\bar{\mathbf{b}})}{3} \mathbf{I} \right)$$

Here G is the elastic shear modulus,

$$\begin{aligned} \bar{\mathbf{b}} &= J^{-2/3} \mathbf{F} \mathbf{F}^T \\ J &= \det \mathbf{F} \end{aligned}$$

is the unimodular left Cauchy-Green tensor, and

$$\lambda_r^2 = \frac{Tr(\bar{\mathbf{b}})}{3N}$$

is the relative network stretch.

The viscoelastic stress is based on a multiplicative split of the unimodular deformation gradient into unimodular elastic and inelastic parts, respectively,

$$J^{-1/3} \mathbf{F} = \mathbf{F}_e \mathbf{F}_i$$

and we define

$$\mathbf{b}_e = \mathbf{F}_e \mathbf{F}_e^T$$

to be the elastic left Cauchy-Green tensor. The viscoelastic stress is given as

$$\boldsymbol{\tau}_v = \frac{G_v}{3} \frac{3 - \lambda_v^2}{1 - \lambda_v^2} \left(\mathbf{b}_e - \frac{\text{Tr}(\mathbf{b}_e)}{3} \mathbf{I} \right)$$

where

$$\lambda_v^2 = \frac{\text{Tr}(\mathbf{b}_e)}{3N_v}$$

is the relative network stretch for the viscoelastic part. The evolution of the elastic left Cauchy-Green tensor can be written

$$\dot{\mathbf{b}}_e = \bar{\mathbf{L}}\mathbf{b}_e + \mathbf{b}_e\bar{\mathbf{L}}^T - 2\mathbf{D}_i\mathbf{b}_e$$

where the inelastic rate-of-deformation tensor is given as

$$\mathbf{D}_i = \dot{\gamma}_0 (\lambda_i - 0.999)^c \left(\frac{\|\boldsymbol{\tau}_v\|}{\hat{\tau}\sqrt{2}} \right)^m \frac{\boldsymbol{\tau}_v}{\|\boldsymbol{\tau}_v\|}$$

and

$$\bar{\mathbf{L}} = \mathbf{L} - \frac{\text{Tr}(\mathbf{L})}{3} \mathbf{I}$$

is the deviatoric velocity gradient. The stretch of a single chain relaxing in a polymer is linked to the inelastic right Cauchy-Green tensor as

$$\lambda_i^2 = \frac{\text{Tr}(\mathbf{F}_i^T \mathbf{F}_i)}{3} \geq 1,$$

and this stretch is available as the plastic strain variable in the post processing of this material. The volumetric part is elastic and governed by the bulk modulus, the pressure for this model is given as

$$p = K(J^{-1} - 1).$$

***MAT_CWM**

This is material type 270. This is a thermo-elastic-plastic model with kinematic hardening that allows for material creation as well as annealing triggered by temperature. The acronym CWM stands for Computational Welding Mechanics, Lindström (2013, 2015), and the model is intended to be used for simulating multistage weld processes. This model is available for solid and shell elements.

Card 1	1	2	3	4	5	6	7	8
Variable	MID	RO	LCEM	LCPR	LCSY	LCHR	LCAT	BETA
Type	A8	F	F	F	F	F	F	F
Default	none	none	none	none	none	none	none	None

Card 2	1	2	3	4	5	6	7	8
Variable	TASTART	TAEND	TLSTART	TLEND	EGHOST	PGHOST	AGHOST	
Type	F	F	F	F	F	F	F	
Default	none	none	none	none	none	none	none	

Optional Phase Change Card.

Card 3	1	2	3	4	5	6	7	8
Variable	T2PHASE	T1PHASE	ANOPT	POSTV				
Type	F	F	F	I				
Default	optional	optional	0.0	0				

VARIABLE**DESCRIPTION**

MID

Material identification. A unique number or label not exceeding 8 characters must be specified.

RO	Material density
LCEM	Load curve for Young's modulus as function of temperature
LCPR	Load curve for Poisson's ratio as function of temperature
LCSY	Load curve or table for yield stress. GT.0: Yield stress is a load curve as function of temperature. LT.0: LCSY is a table of yield curves for different temperatures. Each yield curve is a function of plastic strain.
LCHR	Load curve for hardening modulus as function of temperature. LCHR is not used for LCSY.LT.0. Hardening modulus is then calculated from yield curve slope.
LCAT	Load curve (or table) for thermal expansion coefficient as function of temperature (and maximum temperature up to current time). In the case of a table, load curves are listed according to their maximum temperature.
BETA	Fraction isotropic hardening between 0 and 1 EQ.0: Kinematic hardening EQ.1: Isotropic hardening
TASTART	Annealing temperature start
TAEND	Annealing temperature end
TLSTART	Birth temperature start
TLEND	Birth temperature end
EGHOST	Young's modulus for ghost (quiet) material
PGHOST	Poisson's ratio for ghost (quiet) material
AGHOST	Thermal expansion coefficient for ghost (quiet) material
T2PHASE	Temperature at which phase change commences
T1PHASE	Temperature at which phase change ends

ANOPT	Annealing option for thermal expansion. EQ.0: No modification for thermal expansion EQ.1: TAEND defines the upper limit (cut-off temperature) for evaluation of thermal expansion. LT.0: ANOPT defines the upper limit (cut-off temperature) for evaluation of thermal expansion
POSTV	Define additional history variables that might be useful for post-processing. See remarks below for details.

Remarks:

1. **Material birth.** This material is initially in a quiet state, sometimes referred to as a ghost material. In this state the material has the thermo-elastic properties defined by the quiet Young's modulus, quiet Poisson's ratio and quiet thermal expansion coefficient. These should represent void, i.e., the Young's modulus should be small enough to not influence the surroundings but large enough to avoid numerical problems. A quiet material stress should never reach the yield point. When the temperature reaches the birth temperature, a history variable representing the indicator of the welding material is incremented. This variable follows

$$\gamma(t) = \min \left(1, \max \left[0, \frac{T_{\max} - T_l^{\text{start}}}{T_l^{\text{end}} - T_l^{\text{start}}} \right] \right)$$

where $T_{\max} = \max_{s \leq t} T(s)$. This parameter is available as history variable 9 in the output database. The effective thermo-elastic material properties are interpolated as

$$\begin{aligned} E &= E(T)\gamma + E_{\text{quiet}}(1 - \gamma) \\ \nu &= \nu(T)\gamma + \nu_{\text{quiet}}(1 - \gamma) \\ \alpha &= \alpha(T, T_{\max})\gamma + \alpha_{\text{quiet}}(1 - \gamma) \end{aligned}$$

where E , ν , and α are the Young's modulus, Poisson's ratio and thermal expansion coefficient, respectively. Here, the thermal expansion coefficient is either a temperature dependent curve, or a collection of temperature dependent curves, ordered in a table according to maximum temperature T_{\max} .

2. **Stress Update.** The stress update follows a classical isotropic associative thermo-elastic-plastic approach with kinematic hardening that is summarized in the following. The explicit temperature dependence is sometimes dropped for the sake of clarity.

The stress evolution is given as

$$\dot{\sigma} = \mathbf{C}(\dot{\epsilon} - \dot{\epsilon}_p - \dot{\epsilon}_T)$$

where \mathbf{C} is the effective elastic constitutive tensor and

$$\begin{aligned}\dot{\epsilon}_T &= \alpha \dot{T} \mathbf{I} \\ \dot{\epsilon}_p &= \dot{\epsilon}_p \frac{3 \mathbf{s} - \boldsymbol{\kappa}}{2 \bar{\sigma}}\end{aligned}$$

are the thermal and plastic strain rates, respectively. The latter expression includes the deviatoric stress

$$\mathbf{s} = \boldsymbol{\sigma} - \frac{1}{3} \text{Tr}(\boldsymbol{\sigma}) \mathbf{I},$$

the back stress $\boldsymbol{\kappa}$ and the effective stress

$$\bar{\sigma} = \sqrt{\frac{3}{2} (\mathbf{s} - \boldsymbol{\kappa}) : (\mathbf{s} - \boldsymbol{\kappa})}$$

that are involved in the plastic equations. To this end, the effective yield stress is given as

$$\sigma_Y = \sigma_Y(T) + \beta H(T) \epsilon_p$$

and plastic strains evolve when the effective stress exceeds this value. The back stress evolves as

$$\dot{\boldsymbol{\kappa}} = (1 - \beta) H(T) \dot{\epsilon}_p \frac{\mathbf{s} - \boldsymbol{\kappa}}{\bar{\sigma}}$$

where $\dot{\epsilon}_p$ is the rate of effective plastic strain that follows from consistency equations.

3. **Annealing.** When the temperature reaches the start annealing temperature, the material starts assuming its virgin properties. Beyond the start annealing temperature it behaves as an ideal elastic-plastic material but with no evolution of plastic strains. The resetting of effective plastic properties in the annealing temperature interval is done by modifying the effective plastic strain and back stress before the stress update as

$$\begin{aligned}\epsilon_p^{n+1} &= \epsilon_p^n \max \left[0, \min \left(1, \frac{T - T_a^{\text{end}}}{T_a^{\text{start}} - T_a^{\text{end}}} \right) \right] \\ \boldsymbol{\kappa}^{n+1} &= \boldsymbol{\kappa}^n \max \left[0, \min \left(1, \frac{T - T_a^{\text{end}}}{T_a^{\text{start}} - T_a^{\text{end}}} \right) \right]\end{aligned}$$

Depending on the choice for parameter ANOPT, annealing may also affect the thermal expansion of the structure. A cut-off temperature can be defined for the evaluation of the thermal expansion. Above this temperature limit, further expansion is suppressed. The cut-off temperature does not necessarily coincide with the annealing temperature.

4. **Average temperature rate.** The optional Card 3 is used to set history variable 11, which is the average temperature rate by which the temperature has gone from T2PHASE to T1PHASE. To fringe this variable the range should be set to positive values since it is during the simulation temporarily used to store the time when the material has reached temperature T2PHASE and is then stored as

a negative value. A strictly positive value means that the material has reached temperature T2PHASE and gone down to T1PHASE and the history variable is $(T2PHASE - T1PHASE)/(T1 - T2)$, where T2 is the time when temperature T2PHASE is reached and T1 is the time when temperature T1PHASE is reached. Note that $T2PHASE > T1PHASE$ and $T1 > T2$. A value of zero means that the element has not yet reached temperature T2PHASE. A strictly negative value means that the element has reached temperature T2PHASE but not yet T1PHASE.

- History variables.** This material formulation outputs additional data for post-processing to the set of history variables if requested by the user. The parameter POSTV defines the data to be written. Its value is calculated as

$$POSTV = a_1 + 2 a_2 + 4 a_3 + 8 a_4$$

Each flag a_i is a binary (can be either 1 or 0) and corresponds to one particular post-processing variable according to the following table.

Flag	Description	Variables	# hist
a_1	Accumulated thermal strain	ϵ_T	1
a_2	Accumulated strain tensor	ϵ	6
a_3	Plastic strain tensor	ϵ_p	6
a_4	Equivalent strain	ϵ_{VM}	1

The above table also shows the order of output as well as the number of extra history variables associated with the particular flag. The values of these user-defined histories are reset when the temperature is in the annealing range.

In total NXH extra variables are required depending on the choice of parameter POSTV. For example, the maximum number of additional variables is $NXH = 14$ for $POSTV = 15$.

A complete list of history variables for the material is given in the following table. "Position" refers to the history variable number as listed by LS-PrePost when post-processing the d3plot database. The variable NEIPS in *DATABASE_EXTENT_BINARY must to set to output these history variables.

Position	Description
1-6	Back stress
7	Temperature at last time step
8	Yield indicator: 1 if yielding, else 0
9	Welding material indicator: 0 for ghost material, else 1

10	Maximum temperature reached
11	Average temperature rate going from T2PHASE to T1PHASE
12 →	User-defined history data as described in the
11+NXH	preceding table

***MAT_POWDER**

This is Material Type 271. This model is used to analyze the compaction and sintering of cemented carbides and the model is based on the works of Brandt (1998). This material is only available for solid elements.

Card Summary:

Card 1. This card is required.

MID	RO	P11	P22	P33	P12	P23	P13
-----	----	-----	-----	-----	-----	-----	-----

Card 2. This card is required.

E0	LCK	PR	LCX	LCY	LCC	L	R
----	-----	----	-----	-----	-----	---	---

Card 3. This card is required.

CA	CD	CV	P	LCH	LCFI	SINT	TZRO
----	----	----	---	-----	------	------	------

Card 3.1. This card is included if and only if SINT = 1.

LCFK	LCFS2	DV1	DV2	DS1	DS2	OMEGA	RGAS
------	-------	-----	-----	-----	-----	-------	------

Card 3.2. This card is included if and only if SINT = 1.

LCPR	LCFS3	LCTAU	ALPHA	LCFS1	GAMMA	L0	LCFKS
------	-------	-------	-------	-------	-------	----	-------

Data Card Definitions:

Card 1	1	2	3	4	5	6	7	8
Variable	MID	RO	P11	P22	P33	P12	P23	P13
Type	A	F	F	F	F	F	F	F
Default	none	none	none	none	none	none	none	none

VARIABLE**DESCRIPTION**

MID

Material identification. A unique number or label must be specified (see *PART).

VARIABLE	DESCRIPTION
-----------------	--------------------

RO	Mass density
----	--------------

PIJ	Initial compactness tensor P_{ij}
-----	-------------------------------------

Card 2	1	2	3	4	5	6	7	8
Variable	E0	LCK	PR	LCX	LCY	LCC	L	R
Type	F	I	F	I	I	I	F	F
Default	none	none	none	none	none	none	none	none

VARIABLE	DESCRIPTION
-----------------	--------------------

E0	Initial anisotropy variable e (value between 1 and 2)
----	---

LCK	Load curve ID for bulk modulus K as function of relative density d
-----	--

PR	Poisson's ratio, ν
----	------------------------

LCX	Load curve ID for hydrostatic compressive yield X as function of relative density d
-----	---

LCY	Load curve for uniaxial compressive yield Y as function of relative density d
-----	---

LCC	Load curve ID for shear yield C_0 as function of relative density d
-----	---

L	Yield surface parameter L relating hydrostatic compressive yield to point on hydrostatic axis with maximum strength
---	---

R	Yield surface parameter R governing the shape of the yield surface
---	--

Card 3	1	2	3	4	5	6	7	8
Variable	CA	CD	CV	P	LCH	LCFI	SINT	TZRO
Type	F	F	F	F	I	I	F	F
Default	none	none	none	none	none	none	0.0	none

VARIABLE**DESCRIPTION**

CA	Hardening parameter c_a
CD	Hardening parameter c_d
CV	Hardening parameter c_v
P	Hardening exponent p
LCH	Load curve ID giving back stress parameter, H , as function of hardening parameter e
LCFI	Load curve ID giving plastic strain evolution angle, ϕ , as function of relative volumetric stress
SINT	Activate sintering: EQ.0.0: sintering off EQ.1.0: sintering on
TZRO	Absolute zero temperature, T_0

Sintering Card 1. Additional card for SINT = 1.

Card 3.1	1	2	3	4	5	6	7	8
Variable	LCFK	LCFS2	DV1	DV2	DS1	DS2	OMEGA	RGAS
Type	I	I	F	F	F	F	F	F
Default	none	none	none	none	none	none	none	none

VARIABLE	DESCRIPTION
LCFK	Load curve ID for viscous compliance, f_K , as function of relative density, d
LCFS2	Load curve ID for viscous compliance, f_{S2} , as function of temperature, T
DV1	Volume diffusion coefficient d_{V1}
DV2	Volume diffusion coefficient d_{V2}
DS1	Surface diffusion coefficient d_{S1}
DS2	Surface diffusion coefficient d_{S2}
OMEGA	Blending parameter ω
RGAS	Universal gas constant, R_{gas}

Sintering Card 2. Additional card for SINT = 1.

Card 3.2	1	2	3	4	5	6	7	8
Variable	LCPR	LCFS3	LCTAU	ALPHA	LCFS1	GAMMA	L0	LCFKS
Type	I	I	I	F	I	F	F	I
Default	none	none	none	none	none	none	none	none

VARIABLE	DESCRIPTION
LCPR	Load curve ID for viscous Poisson's ratio, ν^v , as a function of relative density, d
LCFS3	Load curve ID for evolution of mobility factor, f_{S3} , as function of temperature, T
LCTAU	Load curve for relaxation time, τ , as function of temperature, T
ALPHA	Thermal expansion coefficient, α
LCFS1	Load curve ID for sintering stress scaling, f_{S1} , as function of relative density, d

VARIABLE	DESCRIPTION
GAMMA	Surface energy density, γ , which affects sintering stress
L0	Grain size, l_0 , which affects sintering stress
LCFKS	Load curve ID scaling bulk modulus, f_{KS} , as function of temperature T

Remarks:

This model is intended to be used in two stages. During the first step the compaction of a powder specimen is simulated after which the results are dumped to file, and in a subsequent step the model is restarted for simulating sintering of the compacted specimen. In the following, an overview of the two different models is given, for a detailed description we refer to Brandt (1998). The progressive stiffening in the material during compaction makes it more or less necessary to run double precision and with constraint contacts to avoid instabilities, unfortunately this currently limits the use of this material to the smp version of LS-DYNA.

The powder compaction model makes use of a multiplicative split of the deformation gradient into a plastic and elastic part according to

$$\mathbf{F} = \mathbf{F}_e \mathbf{F}_p ,$$

where the plastic deformation gradient maps the initial reference configuration to an intermediate relaxed configuration

$$\delta \tilde{\mathbf{x}} = \mathbf{F}_p \delta \mathbf{X}$$

and subsequently the elastic part maps this onto the current loaded configuration

$$\delta \mathbf{x} = \mathbf{F}_e \delta \tilde{\mathbf{x}} .$$

The compactness tensor, \mathbf{P} , then maps the intermediate configuration onto a virtual fully compacted configuration

$$\delta \tilde{\mathbf{x}} = \mathbf{P} \delta \tilde{\mathbf{x}}$$

and we define the relative density as

$$d = \det \mathbf{P} = \frac{\rho}{\bar{\rho}} ,$$

where ρ and $\bar{\rho}$ denote the current and fully compacted density, respectively. The elastic properties depend highly on the relative density through the bulk modulus $K(d)$, but the Poisson's ratio is assumed constant.

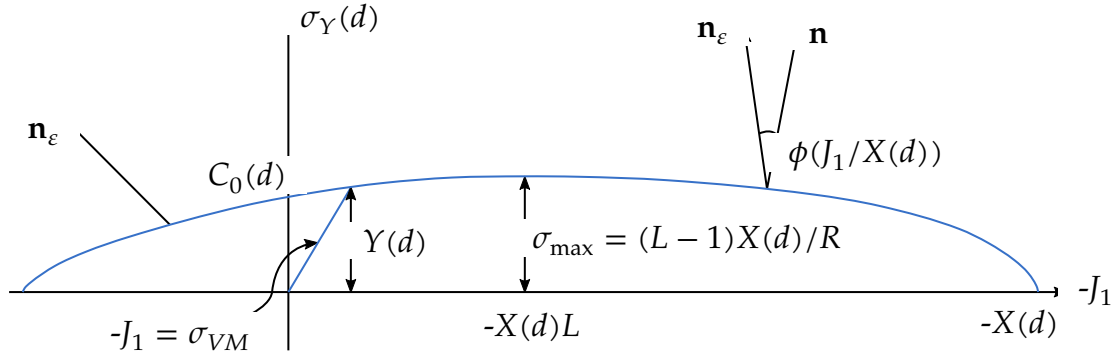

Figure M271-1. Yield Surface

The yield surface is represented by two functions in the Rendulic plane according to

$$\sigma_Y(d) = \begin{cases} \frac{1}{2}C_0(d) - C_1(d)J_1 - C_2(d)J_1^2 & J_1 \geq LX(d) \\ \frac{\sqrt{[(L-1)X(d)]^2 - [J_1 - LX(d)]^2}}{R} & J_1 < LX(d) \end{cases}$$

and is in this way capped in both compression and tension. Here

$$J_1 = 3\sigma^m = \text{Tr}(\sigma) .$$

The polynomial coefficients in the expression above are chosen to give continuity at $J_1 = LX(d)$ and to give the uniaxial compressive strength $Y(d)$. Yielding is assumed to occur when the equivalent stress (note the definition) equals the yield stress

$$\sigma_{eq} = \frac{\sigma_{VM}}{\sqrt{3}} = \sqrt{\frac{1}{2} \mathbf{s} : \mathbf{s}} \leq \sigma_Y(d) ,$$

where

$$\mathbf{s} = \frac{\boldsymbol{\sigma} - \sigma^m \mathbf{I}}{\sigma^d} - \boldsymbol{\kappa}$$

in which the last term is the back stress to be described below. The yield surface does not depend on the third stress invariant. The plastic flow is non-associated and its direction is given by

$$\mathbf{n}_\epsilon = \begin{pmatrix} \cos\phi & -\sin\phi \\ \sin\phi & \cos\phi \end{pmatrix} \mathbf{n} ,$$

where

$$\mathbf{n} = \frac{\sigma_Y(d)}{\sigma_{max}} \begin{pmatrix} \frac{\partial \sigma_Y}{\partial J_1} \\ 1 \end{pmatrix}$$

is the normal to the yield surface as depicted in the Rendulic plane above (note the sign of J_1). The angle ϕ is a function of and defined only for positive values of the relative volumetric stress $J_1/X(d) > 0$; for negative values ϕ is determined internally to achieve

smoothness in the plastic flow direction and to avoid numerical problems at the tensile cap point. The above equations are for illustrative purposes, from now on the plastic flow direction is generalized to a second order tensor. The plastic flow rule is then

$$\dot{\boldsymbol{\epsilon}}_p = \lambda \mathbf{n}_{\epsilon}, \quad \dot{\epsilon}_p^m = \frac{1}{3} \text{Tr}(\dot{\boldsymbol{\epsilon}}_p), \quad \dot{\boldsymbol{\epsilon}}_p^d = \dot{\boldsymbol{\epsilon}}_p - \dot{\epsilon}_p^m \mathbf{I} .$$

The evolution of the compactness tensor is directly related to the evolution of plastic strain as

$$\dot{\mathbf{P}} = -\frac{1}{2} (\dot{\boldsymbol{\epsilon}}_p \mathbf{P} + \mathbf{P} \dot{\boldsymbol{\epsilon}}_p) ,$$

and thus, the relative density is given by

$$\dot{d} = -3\dot{\epsilon}_p^m d .$$

The back stress is assumed coaxial with the deviatoric part of the compactness tensor and given by

$$\boldsymbol{\kappa} = J_1 H(e) \left(\mathbf{P} - \frac{\text{Tr}(\mathbf{P})}{3} \mathbf{I} \right) ,$$

where e is a measure of intensity of anisotropy. This takes a value between 1 and 2 and evolves with plastic strain and plastic work according to

$$\dot{e} = c_a \sqrt{\frac{1}{2} \dot{\boldsymbol{\epsilon}}_p^d : \dot{\boldsymbol{\epsilon}}_p^d} - c_v J_1 \dot{\epsilon}_p^m W(d, J_1) + c_d \dot{\boldsymbol{\epsilon}}_p^d : \boldsymbol{\sigma} W(d, J_1) ,$$

where

$$W(d, J_1) = - \left[\frac{J_1}{X(d)} \right]^p \int_{d_0}^d \frac{X(\xi)}{3\xi} d\xi$$

and d_0 is the density in the initial uncompressed configuration. The stress update is completed by the rate equation of stress

$$\dot{\boldsymbol{\sigma}} = \mathbf{C}(d) : (\dot{\boldsymbol{\epsilon}} - \dot{\boldsymbol{\epsilon}}_p) ,$$

where $\mathbf{C}(d)$ is the elastic constitutive matrix.

The sintering model is a thermo and viscoelastic model where the evolution of the mean and deviatoric stress can be written as

$$\begin{aligned} \dot{\sigma}^m &= 3K^s (\dot{\epsilon}^m - \dot{\epsilon}_T - \dot{\epsilon}_p^m) \\ \dot{\sigma}^d &= 2G^s (\dot{\boldsymbol{\epsilon}}^d - \dot{\boldsymbol{\epsilon}}_p^d) \end{aligned}$$

The thermal strain rate is given by the thermal expansion coefficient as

$$\dot{\epsilon}_T = \alpha \dot{T} ,$$

and the bulk and shear modulus are the same as for the compaction model with the exception that they are scaled by a temperature curve

$$K^s = f_{KS}(T)K(d)$$

$$G^s = \frac{3(1 - 2\nu)}{2(1 + \nu)}K^s$$

The inelastic strain rates are different from the compaction model and is here given by

$$\dot{\epsilon}_p = \frac{\sigma^d}{2G^v} + \frac{\sigma^m - \sigma^s}{3K^v} \mathbf{I}$$

which results in a viscoelastic behavior depending on the viscous compliance and sintering stress. The viscous bulk compliance can be written

$$\frac{1}{K^v} = 3f_K(d) \left\{ d_{V1} \exp \left[-\frac{d_{V2}}{R_{gas}(T - T_0)} \right] + \omega d_{S1} \exp \left[-\frac{d_{S2}}{R_{gas}(T - T_0)} \right] \right\} [1 + f_{S2}(T)\zeta]$$

from which the viscous shear compliance is modified with aid of the viscous Poisson's ratio

$$\frac{1}{G^v} = \frac{2[1 + \nu^v(d)]}{3[1 - 2\nu^v(d)]} \frac{1}{K^v} .$$

The mobility factor ζ evolves with temperature according to

$$\dot{\zeta} = \frac{f_{S3}(T)\dot{T} - \zeta}{\tau(T)} ,$$

and the sintering stress is given as

$$\sigma^s = f_{S1}(d) \frac{\gamma}{l_0} .$$

All this is accompanied with, again, the evolution of relative density given as

$$\dot{d} = -3\dot{\epsilon}_p^m d .$$

***MAT_RHT**

This is Material Type 272. This model is used to analyze concrete structures subjected to impulsive loadings; see Riedel et.al. (1999) and Riedel (2004).

Card Summary:

Card 1. This card is required.

MID	RO	SHEAR	ONEMPA	EPSF	B0	B1	T1
-----	----	-------	--------	------	----	----	----

Card 2. This card is required.

A	N	FC	FS*	FT*	Q0	B	T2
---	---	----	-----	-----	----	---	----

Card 3. This card is required.

E0C	E0T	EC	ET	BETAC	BETAT	PTF	
-----	-----	----	----	-------	-------	-----	--

Card 4. This card is required.

GC*	GT*	XI	D1	D2	EPM	AF	NF
-----	-----	----	----	----	-----	----	----

Card 5. This card is required.

GAMMA	A1	A2	A3	PEL	PCO	NP	ALPHA0
-------	----	----	----	-----	-----	----	--------

Data Card Definitions:

Card 1	1	2	3	4	5	6	7	8
Variable	MID	RO	SHEAR	ONEMPA	EPSF	B0	B1	T1
Type	A8	F	F	F	F	F	F	F

VARIABLE**DESCRIPTION**

MID	Material identification. A unique number or label not exceeding 8 characters must be specified.
RO	Mass density
SHEAR	Elastic shear modulus

VARIABLE	DESCRIPTION
ONEMPA	Unit conversion factor defining 1 MPa in the pressure units used. It can also be used for automatic generation of material parameters for a given compressive strength (see remarks). EQ.0: defaults to 1.0 EQ.-1: parameters generated in m, s and kg (Pa) EQ.-2: parameters generated in mm, s and tonne (MPa) EQ.-3: parameters generated in mm, ms and kg (GPa) EQ.-4: parameters generated in in, s and dozens of slugs (psi) EQ.-5: parameters generated in mm, ms and g (MPa) EQ.-6: parameters generated in cm, μ s and g (Mbar) EQ.-7: parameters generated in mm, ms and mg (kPa)
EPSF	Eroding plastic strain (default is 2.0)
B0	Parameter for polynomial EOS
B1	Parameter for polynomial EOS
T1	Parameter for polynomial EOS

Card 2	1	2	3	4	5	6	7	8
Variable	A	N	FC	FS*	FT*	Q0	B	T2
Type	F	F	F	F	F	F	F	F

VARIABLE	DESCRIPTION
A	Failure surface parameter <i>A</i>
N	Failure surface parameter <i>N</i>
FC	Compressive strength
FS*	Relative shear strength
FT*	Relative tensile strength
Q0	Lode angle dependence factor

VARIABLE	DESCRIPTION
-----------------	--------------------

B Lode angle dependence factor

T2 Parameter for polynomial EOS

Card 3	1	2	3	4	5	6	7	8
Variable	E0C	E0T	EC	ET	BETAC	BETAT	PTF	
Type	F	F	F	F	F	F	F	

VARIABLE	DESCRIPTION
-----------------	--------------------

E0C Reference compressive strain rate

E0T Reference tensile strain rate

EC Break compressive strain rate

ET Break tensile strain rate

BETAC Compressive strain rate dependence exponent (optional)

BETAT Tensile strain rate dependence exponent (optional)

PTF Pressure influence on plastic flow in tension (default is 0.001)

Card 4	1	2	3	4	5	6	7	8
Variable	GC*	GT*	XI	D1	D2	EPM	AF	NF
Type	F	F	F	F	F	F	F	F

VARIABLE	DESCRIPTION
-----------------	--------------------

GC* Compressive yield surface parameter

GT* Tensile yield surface parameter

XI Shear modulus reduction factor

D1 Damage parameter

VARIABLE	DESCRIPTION
D2	Damage parameter
EPM	Minimum damaged residual strain
AF	Residual surface parameter
NF	Residual surface parameter

Card 5	1	2	3	4	5	6	7	8
Variable	GAMMA	A1	A2	A3	PEL	PCO	NP	ALPHA0
Type	F	F	F	F	F	F	F	F

VARIABLE	DESCRIPTION
GAMMA	Gruneisen gamma
A1	Hugoniot polynomial coefficient
A2	Hugoniot polynomial coefficient
A3	Hugoniot polynomial coefficient
PEL	Crush pressure
PCO	Compaction pressure
NP	Porosity exponent
ALPHA	Initial porosity

Remarks:

In the RHT model, the shear and pressure part is coupled in which the pressure is described by the Mie-Gruneisen form with a polynomial Hugoniot curve and a $p-\alpha$ compaction relation. For the compaction model, we define a history variable representing the porosity α that is initialized to $\alpha_0 > 1$. This variable represents the current fraction of density between the matrix material and the porous concrete and will decrease with increasing pressure, that is, the reference density is expressed as $\alpha\rho$. The evolution of this variable is given as

$$\alpha(t) = \max \left(1, \min \left\{ \alpha_0, \min_{s \leq t} \left[1 + (\alpha_0 - 1) \left(\frac{p_{\text{comp}} - p(s)}{p_{\text{comp}} - p_{\text{el}}} \right)^N \right] \right\} \right),$$

where $p(t)$ indicates the pressure at time t . This expression also involves the initial pore crush pressure p_{el} , compaction pressure p_{comp} and porosity exponent N . For later use, we define the cap pressure, or current pore crush pressure, as

$$p_c = p_{\text{comp}} - \left(p_{\text{comp}} - p_{\text{el}} \right) \left(\frac{\alpha - 1}{\alpha_0 - 1} \right)^{1/N}.$$

The remainder of the pressure (EOS) model is given in terms of the porous density ρ and specific internal energy e (with respect to the porous density). Depending on user inputs, it is either governed by ($B_0 > 0$)

$$p(\rho, e) = \frac{1}{\alpha} \begin{cases} (B_0 + B_1\eta)\alpha\rho e + A_1\eta + A_2\eta^2 + A_3\eta^3 & \eta > 0 \\ B_0\alpha\rho e + T_1\eta + T_2\eta^2 & \eta < 0 \end{cases}$$

or ($B_0 = 0$)

$$p(\rho, e) = \Gamma\rho e + \frac{1}{\alpha} p_H(\eta) \left[1 - \frac{1}{2} \Gamma\eta \right]$$

$$p_H(\eta) = A_1\eta + A_2\eta^2 + A_3\eta^3$$

together with

$$\eta(\rho) = \frac{\alpha\rho}{\alpha_0\rho_0} - 1.$$

For the shear strength description we use

$$p^* = \frac{p}{f_c}$$

as the pressure normalized with the compressive strength parameter. We also use \mathbf{s} to denote the deviatoric stress tensor and $\dot{\varepsilon}_p$ the plastic strain rate. The effective plastic strain is thus denoted ε_p and can be viewed as such in the post processor of choice.

For a given stress state and rate of loading, the elastic-plastic yield surface for the RHT model is given by

$$\sigma_y(p^*, \mathbf{s}, \dot{\varepsilon}_p, \varepsilon_p^*) = f_c \sigma_y^*(p^*, F_r(\dot{\varepsilon}_p, p^*), \varepsilon_p^*) R_3(\theta, p^*)$$

and is the composition of two functions and the compressive strength parameter f_c . The first describes the pressure dependence for principal stress conditions $\sigma_1 < \sigma_2 = \sigma_3$ and is expressed in terms of a failure surface and normalized plastic strain as

$$\sigma_y^*(p^*, F_r, \varepsilon_p^*) = \sigma_f^* \left(\frac{p^*}{\gamma}, F_r \right) \gamma$$

with

$$\gamma = \varepsilon_p^* + (1 - \varepsilon_p^*) F_e F_c.$$

The failure surface is given as

$$\sigma_f^*(p^*, F_r) = \begin{cases} A \left[p^* - \frac{F_r}{3} + \left(\frac{A}{F_r} \right)^{-1/n} \right]^n & 3p^* \geq F_r \\ \frac{F_r f_s^*}{Q_1} + 3p^* \left(1 - \frac{f_s^*}{Q_1} \right) & F_r > 3p^* \geq 0 \\ \frac{F_r f_s^*}{Q_1} - 3p^* \left(\frac{1}{Q_2} - \frac{f_s^*}{Q_1 f_t^*} \right) & 0 > 3p^* > 3p_t^* \\ 0 & 3p_t^* > 3p^* \end{cases}$$

in which p_t^* is the failure cut-off pressure

$$p_t^* = \frac{F_r Q_2 f_s^* f_t^*}{3(Q_1 f_t^* - Q_2 f_s^*)}$$

F_r is a dynamic increment factor, and

$$\begin{aligned} Q_1 &= R_3 \left(\frac{\pi}{6}, 0 \right) \\ Q_2 &= Q(p^*) \end{aligned}$$

In these expressions, f_t^* and f_s^* are the tensile and shear strength of the concrete relative to the compressive strength f_c and the Q values are introduced to account for the tensile and shear meridian dependence. Further details are given in the following.

To describe reduced strength on shear and tensile meridian the factor

$$R_3(\theta, p^*) = \frac{2(1 - Q^2)\cos\theta + (2Q - 1)\sqrt{4(1 - Q^2)\cos^2\theta + 5Q^2 - 4Q}}{4(1 - Q^2)\cos^2\theta + (1 - 2Q)^2}$$

is introduced, where θ is the Lode angle given by the deviatoric stress tensor \mathbf{s} as

$$\begin{aligned} \cos 3\theta &= \frac{27 \det(\mathbf{s})}{2\bar{\sigma}(\mathbf{s})^3} \\ \bar{\sigma}(\mathbf{s}) &= \sqrt{\frac{3}{2} \mathbf{s} : \mathbf{s}} \end{aligned}$$

The maximum reduction in strength is given as a function of relative pressure

$$Q = Q(p^*) = Q_0 + Bp^*$$

Finally, the strain rate dependence is given by

$$F_r(\dot{\epsilon}_p, p^*) = \begin{cases} F_r^c & 3p^* \geq F_r^c \\ F_r^c - \frac{3p^* - F_r^c}{F_r^c + F_r^t f_t^*} (F_r^t - F_r^c) & F_r^c > 3p^* \geq -F_r^t f_t^* \\ F_r^t & -F_r^t f_t^* > 3p^* \end{cases}$$

in which

$$F_r^c(\dot{\epsilon}_p) = \begin{cases} \left(\frac{\dot{\epsilon}_p}{\dot{\epsilon}_0^c}\right)^{\beta_c/t} & \dot{\epsilon}_p \leq \dot{\epsilon}_0^c \\ \gamma_c^3 \sqrt{\dot{\epsilon}_p} & \dot{\epsilon}_p > \dot{\epsilon}_0^c \end{cases}$$

The parameters involved in these expressions are given as (f_c is in MPa below)

$$\beta_c = \frac{4}{20 + 3f_c}$$

$$\beta_t = \frac{2}{20 + f_c}$$

and $\gamma_{c/t}$ is determined from continuity requirements, but it is also possible to choose the rate parameters via inputs.

The elastic strength parameter used above is given by

$$F_e(p^*) = \begin{cases} g_c^* & 3p^* \geq F_r^c g_c^* \\ g_c^* - \frac{3p^* - F_r^c g_c^*}{F_r^c g_c^* + F_r^t g_t^* f_t^*} (g_t^* - g_c^*) & F_r^c g_c^* > 3p^* \geq -F_r^t g_t^* f_t^* \\ g_t^* & -F_r^t g_t^* f_t^* > 3p^* \end{cases}$$

while the cap of the yield surface is represented by

$$F_c(p^*) = \begin{cases} 0 & p^* \geq p_c^* \\ \sqrt{1 - \left(\frac{p^* - p_u^*}{p_c^* - p_u^*}\right)^2} & p_c^* > p^* \geq p_u^* \\ 1 & p_u^* > p^* \end{cases}$$

where

$$p_c^* = \frac{p_c}{f_c}$$

$$p_u^* = \frac{F_r^c g_c^*}{3} + \frac{G^* \epsilon_p}{f_c}$$

The hardening behavior is described linearly with respect to the plastic strain, where

$$\varepsilon_p^* = \min\left(\frac{\varepsilon_p}{\varepsilon_p^h}, 1\right)$$

$$\varepsilon_p^y = \frac{\sigma_y(p^*, \mathbf{s}, \dot{\varepsilon}_p, \varepsilon_p^*) (1 - F_e F_c)}{\gamma 3G^*}$$

here

$$G^* = \zeta G$$

where G is the shear modulus of the virgin material and ζ is a reduction factor representing the hardening in the model.

When hardening states reach the ultimate strength of the concrete on the failure surface, damage is accumulated during further inelastic loading controlled by plastic strain. To this end, the plastic strain at failure is given as

$$\varepsilon_p^f = \begin{cases} D_1 [p^* - (1 - D)p_t^*]^{D_2} & p^* \geq (1 - D)p_t^* + \left(\frac{\varepsilon_p^m}{D_1}\right)^{1/D_2} \\ \varepsilon_p^m & (1 - D)p_t^* + \left(\frac{\varepsilon_p^m}{D_1}\right)^{1/D_2} > p^* \end{cases}$$

The damage parameter is accumulated with plastic strain according to

$$D = \int_{\varepsilon_p^h}^{\varepsilon_p} \frac{d\varepsilon_p}{\varepsilon_p^f}$$

and the resulting damage surface is given as

$$\sigma_d(p^*, \mathbf{s}, \dot{\varepsilon}_p) = \begin{cases} \sigma_y(p^*, \mathbf{s}, \dot{\varepsilon}_p, 1) (1 - D) + D f_c \sigma_r^*(p^*) & 0 \leq p^* \\ \sigma_y(p^*, \mathbf{s}, \dot{\varepsilon}_p, 1) \left(1 - D - \frac{p^*}{p_t^*}\right) & (1 - D)p_t^* \leq p^* < 0 \end{cases}$$

where

$$\sigma_r^*(p^*) = A_f \{p^*\}^{n_f} .$$

Plastic flow occurs in the direction of deviatoric stress, meaning

$$\dot{\varepsilon}_p \sim \mathbf{s} ,$$

but for tension there is an option to set the parameter PFC to a number corresponding to the influence of plastic volumetric strain. If $\lambda \leq 1$ is used to denote this parameter, then for the special case of $\lambda = 1$

$$\dot{\varepsilon}_p \sim \mathbf{s} - p \mathbf{I} .$$

This was introduced to reduce noise in tension that was observed on some test problems. A failure strain can be used to erode elements with severe deformation which by default is set to 200%.

For simplicity, automatic generation of material parameters is available using ONEM-PA < 0; no other parameters are needed. If FC = 0 then the 35 MPa strength concrete in Riedel (2004) is generated in the units specified by the value of ONEMPA. For FC > 0 FC then specifies the actual strength of the concrete in the units specified by the value of ONEMPA. The other parameters are generated by interpolating between the 35 MPa and 140 MPa strength concretes as presented in Riedel (2004). Any automatically generated parameter may be overridden by the user; one of these parameters may be the initial porosity ALPHA0 of the concrete.

For post-processing, the following history variables may be of interest:

History Variable	Description
2	Internal energy per volume (ρe)
3	Porosity value (α)
4	Damage value (D)

or as an alternative use a material history list

<i>*DEFINE_MATERIAL_HISTORIES Properties</i>				
Label	Attributes			Description
Damage	-	-	-	Damage value D

*MAT_CONCRETE_DAMAGE_PLASTIC_MODEL

*MAT_CDPM

This is material type 273. CDPM is a damage plastic concrete model based on work published in Grassl et al. (2011, 2013) and Grassl and Jirásek (2006). This model is aimed to simulations where failure of concrete structures subjected to dynamic loadings is sought. It describes the characterization of the failure process subjected to multi-axial and rate-dependent loading. The model is based on effective stress plasticity and with a damage model based on both plastic and elastic strain measures. This material model is available only for solids.

There are a lot of parameters for the advanced user but note that most of them have default values that are based on experimental tests. They might not be useful for all types of concrete and all types of load paths but they are values that can be used as a good starting point. If the default values are not good enough the theory chapter at the end of the parameter description can be of use.

History variables of interest are:

- 1 – kappa, κ , see equations below
- 15 – damage in tension, ω_t , see equations below
- 16 – damage in compression, ω_c , see equations below

More details on this material can be found on:

<http://petergrassl.com/Research/DamagePlasticity/CDPMLSDYNA/index.html>

Card 1	1	2	3	4	5	6	7	8
Variable	MID	R0	E	PR	ECC	QH0	FT	FC
Type	A8	F	F	F	F	F	F	F
Default	none	none	none	0.2	AUTO	0.3	none	none

Card 2	1	2	3	4	5	6	7	8
Variable	HP	AH	BH	CH	DH	AS	DF	FC0
Type	F	F	F	F	F	F	F	F
Default	0.5	0.08	0.003	2.0	1.0E-6	15.0	0.85	AUTO

Card 3	1	2	3	4	5	6	7	8
Variable	TYPE	BS	WF	WF1	FT1	STRFLG	FAILFLG	EFC
Type	F	F	F	F	F	F	F	F
Default	0.0	1.0	none	0.15*WF	0.3*FT	0.0	0.0	1.0E-4

VARIABLE**DESCRIPTION**

MID	Material identification. A unique number or label not exceeding 8 characters must be specified.
RO	Mass density.
E	Young's modulus. The sign determines if an anisotropic (E positive, referred to as ISOFLAG = 0 in the remarks) or an isotropic (E negative, referred to as ISOFLAG = 1 in the remarks) damage formulation is used. The Young's modulus is taken as the absolute value of this parameter.
PR	Poissons ratio
ECC	Eccentricity parameter. EQ.0.0: ECC is calculated from Jirásek and Bazant (2002) as $ECC = \frac{1 + \epsilon}{2 - \epsilon'}, \quad \epsilon = \frac{f_t(f_{bc}^2 - f_c^2)}{f_{bc}(f_c^2 - f_t^2)}, \quad f_{bc} = 1.16f_c$
QH0	Initial hardening defined as FC ₀ /FC where FC ₀ is the compressive stress at which the initial yield surface is reached. Default = 0.3

FT	Uniaxial tensile strength (stress)
FC	Uniaxial compression strength (stress)
HP	Hardening parameter. Default is $HP = 0.5$ which is the value used in Grassl et al. (2011) for strain rate dependent material response ($STRFLG = 1$). For applications without strain rate effect ($STRFLG = 0$) a value of $HP = 0.01$ is recommended, which has been used in Grassl et al. (2013).
AH	Hardening ductility parameter 1
BH	Hardening ductility parameter 2
CH	Hardening ductility parameter 3
DH	Hardening ductility parameter 4
AS	Ductility parameter during damage
DF	Flow rule parameter
FC0	Rate dependent parameter. Only needed if $STRFLG = 1$. Recommended value is 10 MPa, which has to be entered consistently with the system of units used.
TYPE	Flag for damage type. EQ.0.0: Linear damage formulation EQ.1.0: Bi-linear damage formulation EQ.2.0: Exponential damage formulation EQ.3.0: No damage The best results are obtained with the bi-linear formulation.
BS	Damage ductility exponent during damage. Default = 1.0
WF	Tensile threshold value for linear damage formulation. Parameter controlling tensile softening branch for exponential tensile damage formulation.
WF1	Tensile threshold value for the second part of the bi-linear damage formulation. Default = $0.15 \times WF$

FT1	Tensile strength threshold value for bi-linear damage formulation. Default = $0.3 \times FT$
STRFLG	Strain rate flag. EQ.1.0: Strain rate dependent EQ.0.0: No strain rate dependency.
FAILFLG	Failure flag. EQ.0.0: Not active \Rightarrow No erosion. GT.0.0: Active and element will erode if w_t and w_c is equal to 1 in FAILFLG percent of the integration points. If FAILFLG = 0.60, 60% of all integration points must fail before erosion.
EFC	Parameter controlling compressive damage softening branch in the exponential compressive damage formulation. Default = $1.0E-4$

Remarks:

The stress for the anisotropic damage plasticity model (E positive, ISOFLAG = 0) is defined as

$$\sigma = (1 - \omega_t)\sigma_t + (1 - \omega_c)\sigma_c$$

where σ_t and σ_c are the positive and negative part of the effective stress σ_{eff} determined in the principal stress space. The scalar functions ω_t and ω_c are damage parameters.

The stress for the isotropic damage plasticity model (E negative, ISOFLAG = 1) is defined as

$$\sigma = (1 - \omega_t)\sigma_{\text{eff}}$$

The effective stress σ_{eff} is defined according to the damage mechanics convention as

$$\sigma_{\text{eff}} = D_e : (\varepsilon - \varepsilon_p)$$

Plasticity:

The yield surface is described by the Haigh-Westergaard coordinates: the volumetric effective stress σ_v , the norm of the deviatoric effective stress ρ and the Lode angle θ , and it is given by

$$f_p(\sigma_v, \rho, \theta, \kappa) = \left[[1 - q_1(\kappa)] \left(\frac{\rho}{\sqrt{6}f_c} + \frac{\sigma_v}{f_c} \right)^2 + \sqrt{\frac{3\rho}{2f_c}} \right]^2 + m_0 q_1(\kappa)^2 q_2(\kappa) \left[\frac{\rho}{\sqrt{6}f_c} r(\cos \theta) + \frac{\sigma_v}{f_c} \right] - q_1^2(\kappa) q_2^2(\kappa).$$

The variables q_1 and q_2 are dependent on the hardening variable κ . The parameter f_c is the uniaxial compressive strength. The shape of the deviatoric section is controlled by the function

$$r(\cos \theta) = \frac{4(1 - e^2) \cos^2 \theta + (2e - 1)^2}{2(1 - e^2) \cos \theta + (2e - 1) \sqrt{4(1 - e^2) \cos^2 \theta + 5e^2 - 4e}}$$

where e is the eccentricity parameter (ECC). The parameter m_0 is the friction parameter and it is defined as

$$m_0 = \frac{3(f_c^2 - f_t^2)}{f_c f_t} \frac{e}{e + 1}$$

where f_t is the tensile strength.

The flow rule is non-associative which means that the direction of the plastic flow is not normal to the yield surface. This is important for concrete since an associative flow rule would give an overestimated maximum stress. The plastic potential is given by

$$g(\sigma_v, \rho, \kappa) = \left\{ [1 - q_1(\kappa)] \left(\frac{\rho}{\sqrt{6}f_c} + \frac{\sigma_v}{f_c} \right)^2 + \sqrt{\frac{3\rho}{2f_c}} \right\}^2 + q_1(\kappa) \left(\frac{m_0 \rho}{\sqrt{6}f_c} + \frac{m_g(\sigma_v, \kappa)}{f_c} \right)$$

where

$$m_g(\sigma_v, \kappa) = A_g(\kappa) B_g(\kappa) f_c e^{\frac{\sigma_v - q_2 f_t / 3}{B_g f_c}}$$

and

$$A_g = \frac{3f_t q_2(\kappa)}{f_c} + \frac{m_0}{2}, \quad B_g = \frac{q_2(\kappa)}{3} \frac{1 + f_t/f_c}{\ln \frac{A_g}{3q_2 + \frac{m_0}{2}} + \ln \left(\frac{D_f + 1}{2D_f - 1} \right)}$$

The hardening laws q_1 and q_2 control the shape of the yield surface and the plastic potential, and they are defined as

$$\begin{aligned} q_1(\kappa) &= q_{h0} + (1 - q_{h0})(\kappa^3 - 3\kappa^2 + 3\kappa) - H_p(\kappa^3 - 3\kappa^2 + 2\kappa), & \kappa < 1 \\ q_1(\kappa) &= 1, & \kappa \geq 1 \\ q_2(\kappa) &= 1, & \kappa < 1 \\ q_2(\kappa) &= 1 + H_p(\kappa - 1), & \kappa \geq 1 \end{aligned}$$

The evolution for the hardening variable is given by

$$\dot{\kappa} = \frac{4\dot{\lambda} \cos^2 \theta}{x_h(\sigma_v)} \left\| \frac{d\mathcal{G}}{d\sigma} \right\|$$

It sets the rate of the hardening variable to the norm of the plastic strain rate scaled by a ductility measure which is defined below as

$$\begin{aligned} x_h(\sigma_v) &= A_h - (A_h - B_h)e^{-\frac{R_h}{C_h}}, & R_h \geq 0 \\ x_h(\sigma_v) &= E_h e^{\frac{R_h}{F_h}} + D_h, & R_h < 0 \end{aligned}$$

And finally

$$E_h = B_h - D_h, \quad F_h = \frac{(B_h - D_h)C_h}{A_h - B_h}$$

Damage:

Damage is initialized when the equivalent strain $\tilde{\epsilon}$ reaches the threshold value $\epsilon_0 = f_t/E$ where the equivalent strain is defined as

$$\tilde{\epsilon} = \frac{\epsilon_0 m_0}{2} \left[\frac{\rho}{\sqrt{6}f_c} r(\cos\theta) + \frac{\sigma_V}{f_c} \right] + \sqrt{\frac{\epsilon_0^2 m_0^2}{4} \left(\frac{\rho}{\sqrt{6}f_c} r(\cos\theta) + \frac{\sigma_V}{f_c} \right)^2 + \frac{3\epsilon_0^2 \rho^2}{2f_c^2}}$$

Tensile damage is described by a stress-inelastic displacement law. For linear and exponential damage type the stress value f_t and the displacement value w_f must be defined. For the bi-linear type two additional parameters f_{t1} and w_{f1} must be defined, see figure below how the stress softening is controlled by the input parameters.

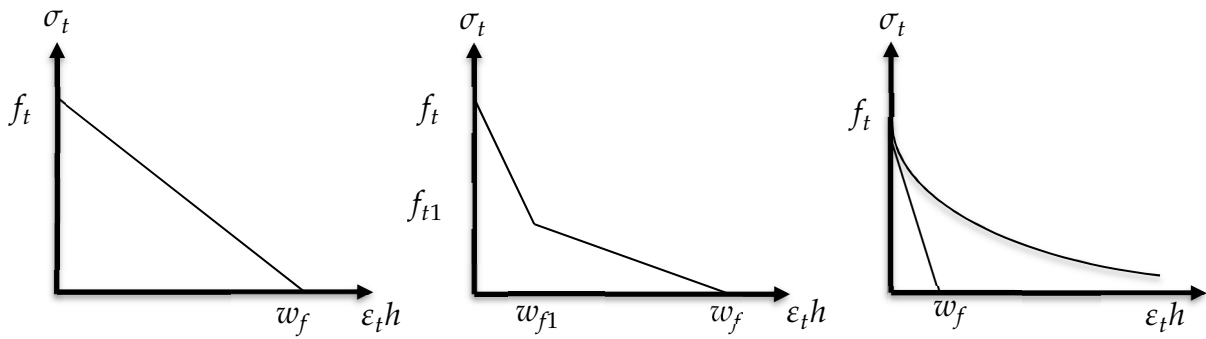

The variable h is a mesh-dependent measure used to convert strains to displacements. The variable ϵ_t is called the inelastic tensile strain and is defined as the sum of the irreversible plastic strain ϵ_p and the reversible strain $w_t(\epsilon - \epsilon_p)$ (in compression $w_c(\epsilon - \epsilon_p)$). To get the influence of multi-axial stress states on the softening a damage ductility measure x_s is added:

$$x_s = 1 + (A_s - 1)R_s^{B_s}$$

Where A_s and B_s are input parameters, and

$$R_s = -\frac{\sqrt{6}\sigma_v}{\rho}, \quad \sigma_v < 0 \text{ and } R_s = 0, \quad \sigma_v > 0$$

The inelastic strain is then modified according:

$$\epsilon_i = \frac{\epsilon_i}{x_s}$$

Compressive damage is controlled by an exponential stress-inelastic strain law. Stress value f_c and inelastic strain ϵ_{fc} need to be specified, see figure below how the stress softening is controlled by the input parameters. A small value of ϵ_{fc} , i.e. 1.0E-4 (default), provides for a rather brittle form of damage.

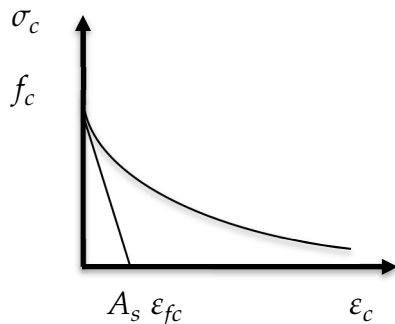

Strain rate:

Concrete is strongly rate dependent. If the loading rate is increased, the tensile and compressive strength increase and are more prominent in tension than in compression. The dependency is taken into account by an additional variable $\alpha_r \geq 1$. The rate dependency is included by scaling both the equivalent strain rate and the inelastic strain. The rate parameter is defined by

$$\alpha_r = (1 - X_{\text{compression}}) \alpha_{rt} + X_{\text{compression}} \alpha_{rc}$$

Where $X_{\text{compression}}$ is continuous compression measure (= 1 means only compression, = 0 means only tension) and for tension we have

$$\alpha_{rt} = \begin{cases} 1 & \dot{\epsilon}_{\text{max}} < 30 \times 10^{-6} \text{ s}^{-1} \\ \left(\frac{\dot{\epsilon}_{\text{max}}}{\dot{\epsilon}_{t0}} \right)^{\delta_t} & 30 \times 10^{-6} < \dot{\epsilon}_{\text{max}} < 1 \text{ s}^{-1} \\ \beta_t \left(\frac{\dot{\epsilon}_{\text{max}}}{\dot{\epsilon}_{t0}} \right)^{\frac{1}{3}} & \dot{\epsilon}_{\text{max}} > 1 \text{ s}^{-1} \end{cases}$$

where $\delta_t = \frac{1}{1+8f_c/f_{c0}}$, $\beta_t = e^{6\delta_t-2}$ and $\dot{\epsilon}_{t0} = 1 \times 10^{-6} \text{ s}^{-1}$. For compression the corresponding rate factor is given by

$$\alpha_{rc} = \begin{cases} 1 & |\dot{\epsilon}_{\text{min}}| < 30 \times 10^{-6} \text{ s}^{-1} \\ \left[S \frac{|\dot{\epsilon}_{\text{min}}|}{\dot{\epsilon}_{c0}} \right]^{1.026\delta_c} & 30 \times 10^{-6} < |\dot{\epsilon}_{\text{min}}| < 1 \text{ s}^{-1} \\ \beta_c \left[\frac{|\dot{\epsilon}_{\text{min}}|}{\dot{\epsilon}_{c0}} \right]^{\frac{1}{3}} & |\dot{\epsilon}_{\text{min}}| > 30 \text{ s}^{-1} \end{cases}$$

where $\delta_c = \frac{1}{5+9f_c/f_{c0}}$, $\beta_c = e^{6.156\delta_c-2}$ and $\dot{\epsilon}_{c0} = 30 \times 10^{-6} \text{ s}^{-1}$. The parameter f_{c0} is an input parameter. A recommended value is 10MPa.

***MAT_PAPER**

This is Material Type 274. This is an orthotropic elastoplastic model for paper materials, based on Xia (2002) and Nygard (2009). It is available for solid and shell elements. Solid elements use a hyperelastic-plastic formulation, while shell elements use a hypoelastic-plastic formulation. The material is available for explicit and implicit simulations; see [Remark 5](#).

Card Summary:

Card 1. This card is required.

MID	RO	E1	E2	E3	PR21	PR32	PR31
-----	----	----	----	----	------	------	------

Card 2. This card is required.

G12	G23	G13	E3C	CC	TWOK		ROT
-----	-----	-----	-----	----	------	--	-----

Card 3. This card is required.

S01	A01	B01	C01	S02	A02	B02	C02
-----	-----	-----	-----	-----	-----	-----	-----

Card 4. This card is required.

S03	A03	B03	C03	S04	A04	B04	C04
-----	-----	-----	-----	-----	-----	-----	-----

Card 5. This card is required.

S05	A05	B05	C05	PRP1	PRP2	PRP4	PRP5
-----	-----	-----	-----	------	------	------	------

Card 6. This card is required.

ASIG	BSIG	CSIG	TAU0	ATAU	BTAU		
------	------	------	------	------	------	--	--

Card 7. This card is required.

AOPT	MACF	XP	YP	ZP	A1	A2	A3
------	------	----	----	----	----	----	----

Card 8. This card is required.

V1	V2	V3	D1	D2	D3	BETA	
----	----	----	----	----	----	------	--

Data Card Definitions:

Card 1	1	2	3	4	5	6	7	8
Variable	MID	RO	E1	E2	E3	PR21	PR32	PR31
Type	A	F	F	F	F	F	F	F
Default	none	none	none	none	none	none	none	none

VARIABLE**DESCRIPTION**

MID	Material identification. A unique number or label must be specified (see *PART).
RO	Material density
E_i	Young's modulus in direction i , E_i
PR_{ij}	Elastic Poisson's ratio ν_{ij}

Card 2	1	2	3	4	5	6	7	8
Variable	G12	G23	G13	E3C	CC	TWOK		ROT
Type	F	F	F	F	F	F		F
Default	none	none	none	none	none	none		0.0

VARIABLE**DESCRIPTION**

G_{ij}	Elastic shear modulus in direction, G_{ij}
E3C	Elastic compression parameter
CC	Elastic compression exponent
TWOK	Exponent in in-plane yield surface

VARIABLE	DESCRIPTION
----------	-------------

ROT	<p>Option for two-dimensional solids (shell element forms 13, 14, or 15):</p> <p>EQ.0.0: No rotation of material axes (default). Direction of material axes are solely defined by AOPT. It is only possible to rotate in shell-plane.</p> <p>EQ.1.0: Rotate coordinate system around material 1-axis such that 2-axis coincides with shell normal. This rotation is done in addition to AOPT.</p> <p>EQ.2.0: Rotate coordinate system around material 2-axis such that 1-axis coincides with shell normal. This rotation is done in addition to AOPT.</p>
-----	---

In plane Yield Surface Card 1.

Card 3	1	2	3	4	5	6	7	8
Variable	S01	A01	B01	C01	S02	A02	B02	C02
Type	F	F	F	F	F	F	F	F
Default	none	none	none	none	none	none	none	none

In plane Yield Surface Card 2.

Card 4	1	2	3	4	5	6	7	8
Variable	S03	A03	B03	C03	S04	A04	B04	C04
Type	F	F	F	F	F	F	F	F
Default	none	none	none	none	none	none	none	none

In plane Yield Surface Card 3.

Card 5	1	2	3	4	5	6	7	8
Variable	S05	A05	B05	C05	PRP1	PRP2	PRP4	PRP5
Type	F	F	F	F	F	F	F	F
Default	none	none	none	none	1/2	2/15	1/2	2/15

VARIABLE**DESCRIPTION**

$S0i$	i^{th} in-plane plasticity yield parameter LT.0.0: $ S0i $ is a load curve ID; see Remark 1 .
$A0i$	i^{th} in-plane plasticity hardening parameter
$B0i$	i^{th} in-plane plasticity hardening parameter
$C0i$	i^{th} in-plane plasticity hardening parameter
PRP1	Tensile plastic Poisson's ratio in direction 1
PRP2	Tensile plastic Poisson's ratio in direction 2
PRP4	Compressive plastic Poisson's ratio in direction 1
PRP5	Compressive plastic Poisson's ratio in direction 2

Out of Plane and Transverse Shear Yield Surface Card.

Card 6	1	2	3	4	5	6	7	8
Variable	ASIG	BSIG	CSIG	TAU0	ATAU	BTAU		
Type	F	F	F	F	F	F		
Default	none	none	none	none	none	none		

VARIABLE**DESCRIPTION**

ASIG	Out-of-plane plasticity yield parameter
------	---

VARIABLE	DESCRIPTION
BSIG	Out-of-plane plasticity hardening parameter
CSIG	Out-of-plane plasticity hardening parameter
TAU0	Transverse shear plasticity yield parameter
ATAU	Transverse shear plasticity hardening parameter
BTAU	Transverse shear plasticity hardening parameter

Orthotropic Parameter Card 1.

Card 7	1	2	3	4	5	6	7	8
Variable	AOPT	MACF	XP	YP	ZP	A1	A2	A3
Type	F	F	F	F	F	F	F	F
Default	none	none	none	none	none	none	none	none

VARIABLE	DESCRIPTION
AOPT	<p>Material axes option (see MAT_OPTIONTROPIC_ELASTIC, particularly the Material Directions section, for details):</p> <p>EQ.0.0: Locally orthotropic with material axes determined by element nodes 1, 2, and 4, as with *DEFINE_COORDINATE_NODES. For shells only, the material axes are then rotated about the normal vector to the surface of the shell by the angle BETA.</p> <p>EQ.1.0: Locally orthotropic with material axes determined by a point, P, in space and the global location of the element center; this is the a-direction. This option is for solid elements only.</p> <p>EQ.2.0: Globally orthotropic with material axes determined by vectors defined below, as with *DEFINE_COORDINATE_VECTOR</p>

VARIABLE

DESCRIPTION

EQ.3.0: Locally orthotropic material axes determined by a vector \mathbf{v} and the normal vector to the plane of the element. The plane of a solid element is the midsurface between the inner surface and outer surface defined by the first four nodes and the last four nodes of the connectivity of the element, respectively. Thus, for solid elements, AOPT = 3 is only available for hexahedrons. \mathbf{a} is determined by taking the cross product of \mathbf{v} with the normal vector, \mathbf{b} is determined by taking the cross product of the normal vector with \mathbf{a} , and \mathbf{c} is the normal vector. Then \mathbf{a} and \mathbf{b} are rotated about \mathbf{c} by an angle BETA. BETA may be set in the keyword input for the element or in the input for this keyword. Note that for solids, the material axes may be switched depending on the choice of MACF. The switch may occur before or after applying BETA depending on the value of MACF.

EQ.4.0: Locally orthotropic in a cylindrical coordinate system with the material axes determined by a vector \mathbf{v} , and an originating point, P , which define the centerline axis. This option is for solid elements only.

LT.0.0: The absolute value of AOPT is a coordinate system ID number (CID on *DEFINE_COORDINATE_OPTION).

MACF

Material axes change flag for solid elements:

EQ.-4: Switch material axes b and c before BETA rotation

EQ.-3: Switch material axes a and c before BETA rotation

EQ.-2: Switch material axes a and b before BETA rotation

EQ.1: No change, default

EQ.2: Switch material axes a and b after BETA rotation

EQ.3: Switch material axes a and c after BETA rotation

EQ.4: Switch material axes b and c after BETA rotation

Figure M2-2 indicates when LS-DYNA applies MACF during the process to obtain the final material axes. If BETA on *ELEMENT_SOLID_{OPTION} is defined, then that BETA is used for the rotation for all AOPT options. Otherwise, if AOPT = 3, the BETA input on Card 8 rotates the axes. For all other values of AOPT, the material axes will be switched as specified by MACF, but no BETA rotation will be performed.

VARIABLE	DESCRIPTION
XP, YP, ZP	Coordinates of point p for AOPT = 1 and 4
A1, A2, A3	Components of vector \mathbf{a} for AOPT = 2

Orthotropic Parameter Card 2.

Card 8	1	2	3	4	5	6	7	8
Variable	V1	V2	V3	D1	D2	D3	BETA	
Type	F	F	F	F	F	F	F	
Default	none	none	none	none	none	none	none	

VARIABLE	DESCRIPTION
V1, V2, V3	Components of vector \mathbf{v} for AOPT = 3 and 4
D1, D2, D3	Components of vector \mathbf{d} for AOPT = 2
BETA	Material angle in degrees for AOPT = 3. It may be overridden on the element card; see *ELEMENT_SHELL_BETA or *ELEMENT_SOLID_ORTHO.

Remarks:

- Hardening Function.** Each hardening function, q_i (note that $q_6 = q_3$), is given by a load curve if $S_i^0 < 0$, otherwise

$$q_i(\epsilon_p^f) = S_i^0 + A_i^0 \tanh(B_i^0 \epsilon_p^f) + C_i^0 \epsilon_p^f.$$

- Material Model for Solid Elements.** The stress-strain relationship for solid elements is based on a multiplicative split of the deformation gradient into an elastic and a plastic part

$$\mathbf{F} = \mathbf{F}_e \mathbf{F}_p .$$

The elastic Green strain is formed as

$$\mathbf{E}_e = \frac{1}{2} (\mathbf{F}_e^T \mathbf{F}_e - \mathbf{I}) ,$$

and the 2nd Piola-Kirchhoff stress as

$$\mathbf{S} = \mathbf{C}\mathbf{E}_e ,$$

where the constitutive matrix is taken as orthotropic and can be represented in Voigt notation by its inverse as

$$\mathbf{C}^{-1} = \begin{bmatrix} \frac{1}{E_1} & -\frac{\nu_{21}}{E_2} & -\frac{\nu_{31}}{E_3} & & & \\ -\frac{\nu_{12}}{E_1} & \frac{1}{E_2} & -\frac{\nu_{32}}{E_3} & & & \\ -\frac{\nu_{13}}{E_1} & -\frac{\nu_{23}}{E_2} & \frac{1}{E_3} & & & \\ & & & \frac{1}{G_{12}} & & \\ & & & & \frac{1}{G_{23}} & \\ & & & & & \frac{1}{G_{13}} \end{bmatrix} .$$

In out-of-plane compression the stress is modified according to

$$S_{33} = C_{31}E_{11}^e + C_{32}E_{22}^e + \begin{cases} E_3E_{33}^e, & E_{33}^e \geq 0 \\ E_3^c[1 - \exp(-C_cE_{33}^e)], & E_{33}^e < 0 \end{cases}$$

Three yield surfaces are present: in-plane, out-of-plane, and transverse shear. The in-plane yield surface is given as (see [Remark 1](#))

$$f = \sum_{i=1}^6 \left[\frac{\max(0, S: N_i)}{q_i(\epsilon_p^f)} \right]^{2k} - 1 \leq 0 ,$$

with the six yield plane normals (in strain Voigt notation)

$$\begin{aligned} N_1 &= \begin{bmatrix} \frac{1}{\sqrt{1 + \nu_{1p}^2}} & -\frac{\nu_{1p}}{\sqrt{1 + \nu_{1p}^2}} & 0 & 0 & 0 & 0 \end{bmatrix}^T , \\ N_2 &= \begin{bmatrix} -\frac{\nu_{2p}}{\sqrt{1 + \nu_{2p}^2}} & \frac{1}{\sqrt{1 + \nu_{2p}^2}} & 0 & 0 & 0 & 0 \end{bmatrix}^T , \\ N_3 &= [0 \ 0 \ 0 \ \sqrt{2} \ 0 \ 0]^T , \\ N_4 &= -\begin{bmatrix} \frac{1}{\sqrt{1 + \nu_{4p}^2}} & -\frac{\nu_{4p}}{\sqrt{1 + \nu_{4p}^2}} & 0 & 0 & 0 & 0 \end{bmatrix}^T , \\ N_5 &= -\begin{bmatrix} -\frac{\nu_{5p}}{\sqrt{1 + \nu_{5p}^2}} & \frac{1}{\sqrt{1 + \nu_{5p}^2}} & 0 & 0 & 0 & 0 \end{bmatrix}^T , \\ N_6 &= -N_3 . \end{aligned}$$

The yield planes describe the following states

Plane	Stress State
1	Tension in material direction 1
2	Tension in material direction 2
3	Positive shear in the 1, 2-direction
4	Compression in material direction 1
5	Compression in material direction 2
6	Negative shear in the 1, 2-direction

The out-of-plane surface is given as

$$g = \frac{-S_{33}}{A_{\sigma} + B_{\sigma} \exp(-C_{\sigma} \epsilon_p^g)} - 1 \leq 0 ,$$

and the transverse shear surface is

$$h = \frac{\sqrt{S_{13}^2 + S_{23}^2}}{\tau_0 + [A_{\tau} - \min(0, S_{33}) B_{\tau}] \epsilon_p^h} - 1 \leq 0 .$$

The flow rule is given by the evolution of the plastic deformation gradient

$$\dot{\mathbf{F}}_p = \mathbf{L}_p \mathbf{F}_p ,$$

where the plastic velocity gradient is given as

$$\mathbf{L}_p = \begin{bmatrix} \dot{\epsilon}_p^f \frac{\partial f}{\partial S_{11}} & \dot{\epsilon}_p^f \frac{\partial f}{\partial S_{12}} & \dot{\epsilon}_p^h \frac{\partial h}{\partial S_{13}} \\ \dot{\epsilon}_p^f \frac{\partial f}{\partial S_{12}} & \dot{\epsilon}_p^f \frac{\partial f}{\partial S_{22}} & \dot{\epsilon}_p^h \frac{\partial h}{\partial S_{23}} \\ \dot{\epsilon}_p^h \frac{\partial h}{\partial S_{13}} & \dot{\epsilon}_p^h \frac{\partial h}{\partial S_{23}} & \dot{\epsilon}_p^g \frac{\partial g}{\partial S_{33}} \end{bmatrix} ,$$

and where it is implicitly assumed that the involved derivatives in the expression of the velocity gradient is appropriately normalized.

3. **Material Model for Shell Elements.** The stress-strain relationship for shell elements is based on an additive split of the rate of deformation into an elastic and a plastic part

$$\mathbf{D} = \mathbf{D}_e + \mathbf{D}_p ,$$

and the rate of Cauchy stress is given by

$$\dot{\sigma} = \mathbf{C} \mathbf{D}_e .$$

In out-of-plane compression the stress rate is modified according to

$$\dot{\sigma}_{33} = C_{31} D_{11}^e + C_{32} D_{22}^e + D_{33}^e \begin{cases} E_3, & \varepsilon_{33}^e \geq 0 \\ E_3^c C_c \exp(-C_c \varepsilon_{33}^e), & \varepsilon_{33}^e < 0 \end{cases}$$

For shell elements, $D_{33}^p = 0$, and only two yield surfaces are present: the in-plane yield surface (see [Remark 1](#)),

$$f = \sum_{i=1}^6 \left[\frac{\max(0, \sigma : N_i)}{q_i(\varepsilon_p^f)} \right]^{2k} - 1 \leq 0 ,$$

and the transverse-shear yield surface,

$$h = \frac{\sqrt{\sigma_{13}^2 + \sigma_{23}^2}}{\tau_0 + [A_\tau - \min(0, \sigma_{33}) B_\tau] \varepsilon_p^h} - 1 \leq 0 .$$

For this case, the plastic flow rule is given by

$$\dot{\varepsilon}_p = \mathbf{D}_p = \mathbf{L}_p ,$$

where the plastic velocity gradient is given as

$$\mathbf{L}_p = \begin{bmatrix} \dot{\varepsilon}_p^f \frac{\partial f}{\partial \sigma_{11}} & \dot{\varepsilon}_p^f \frac{\partial f}{\partial \sigma_{12}} & \dot{\varepsilon}_p^h \frac{\partial h}{\partial \sigma_{13}} \\ \dot{\varepsilon}_p^f \frac{\partial f}{\partial \sigma_{12}} & \dot{\varepsilon}_p^f \frac{\partial f}{\partial \sigma_{22}} & \dot{\varepsilon}_p^h \frac{\partial h}{\partial \sigma_{23}} \\ \dot{\varepsilon}_p^h \frac{\partial h}{\partial \sigma_{13}} & \dot{\varepsilon}_p^h \frac{\partial h}{\partial \sigma_{23}} & 0 \end{bmatrix} .$$

4. **History Variables.** The *Effective Plastic Strain* is

$$\varepsilon_p = \sqrt{(\varepsilon_p^f)^2 + (\varepsilon_p^g)^2 + (\varepsilon_p^h)^2} .$$

The other history variables are listed below.

History Variable #	Solid Elements	Shell Elements
1	ε_p^f	Q_{11} in element to material rotation tensor
2	ε_p^g	Q_{12} in element to material rotation tensor
3	ε_p^h	ε_p^f
4	-	ε_p^h

5. **Tangent Stiffness.** The shell hypoelastic-plastic formulation produces a symmetric tangent stiffness. For the solid hyperelastic-plastic formulation, the tangent stiffness is nonsymmetric. However, unless LCPACK on *CONTROL_IMPLICIT_SOLVER is set to 3, a simplified symmetric tangent will be used for solid elements. This simplified tangent is based on the assumption of small elastic strains. For some problems, using the nonsymmetric tangent significantly improves the convergence rate.

***MAT_SMOOTH_VISCOELASTIC_VISCOPLASTIC**

This is Material Type 275, a smooth viscoelastic viscoplastic model based on the works of Hollenstein et.al. [2013, 2014] and Jabareen [2015]. The stress response is rheologically represented by HJR (Hollenstein-Jabareen-Rubin) elements in parallel (see [Figure M275-1](#)), where each element exhibits combinations of viscoelastic and viscoplastic characteristics. The model is based on large displacement hyper-elastoplasticity and the numerical implementation is strongly objective; this together with the smooth characteristics makes it especially suitable for implicit analysis.

Card 1	1	2	3	4	5	6	7	8
Variable	MID	RO	K					
Type	A	F	F					

HJR Element Cards. At least 1 and optionally up to 6 cards should be input. The next keyword ("*") card terminates this input.

Card 2	1	2	3	4	5	6	7	8
Variable	A0	B0	A1	B1	M	KAPAS	KAPA0	SHEAR
Type	F	F	F	F	F	F	F	F

VARIABLE**DESCRIPTION**

MID	Material identification. A unique number or label must be specified (see *PART).
RO	Mass density
K	Elastic bulk modulus
A0	Rate dependent understress viscoplastic parameter
B0	Rate independent understress plasticity parameter
A1	Rate dependent overstress viscoplastic parameter
B1	Rate independent overstress plasticity parameter
M	Exponential hardening parameter

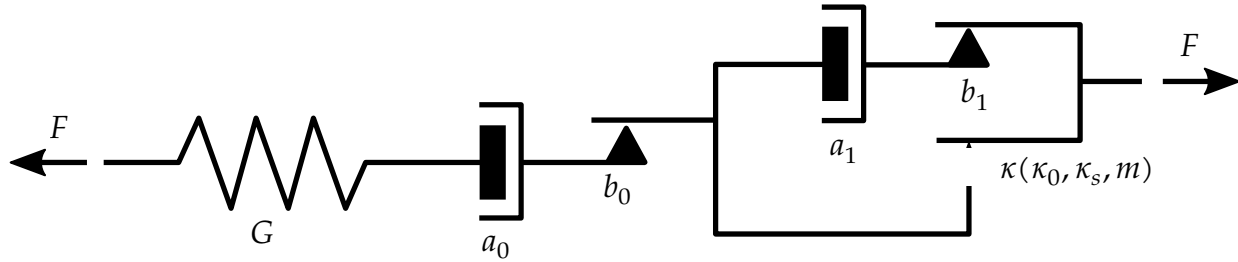

Figure M275-1. Rheological representation of an HJR element, including the associated parameters

VARIABLE	DESCRIPTION
KAPAS	Saturated yield strain
KAPA0	Initial yield strain
SHEAR	Elastic shear modulus

Remarks:

The Cauchy stress for this smooth viscoelastic viscoplastic material is given by

$$\sigma = K(J - 1)\mathbf{I} + \sum_{i=1}^6 \mathbf{s}_i ,$$

where K is the elastic bulk modulus provided on the first card and $J = \det(\mathbf{F})$ is the relative volume with \mathbf{F} being the total deformation gradient. The deviatoric stresses, \mathbf{s}_i , are coming from the HJR (Hollenstein-Jabareen-Rubin) elements in parallel. Up to 6 such elements can be defined for the deviatoric response and a rheological representation of one is shown in Figure M275-1. Each element is associated with 8 material parameters that are provided on the optional cards and characterize its inelastic response. All this allows for a wide range of stress strain relationships. The critical part involves estimating parameters for a given test suite. Some elaboration on the physical interpretation of the individual parameters in the context of uniaxial stress is given following a general description of the model.

We analyze one HJR element by letting $\bar{\mathbf{B}}$ denote the associated isochoric elastic left Cauchy-Green tensor. Define

$$\tilde{\mathbf{B}} = \bar{\mathbf{B}} - \frac{1}{3}\alpha\mathbf{I}, \text{ where } \alpha = \text{tr}(\bar{\mathbf{B}}) .$$

The evolution of $\bar{\mathbf{B}}$ is given by

$$\dot{\bar{\mathbf{B}}} = \mathbf{L}\bar{\mathbf{B}} + \bar{\mathbf{B}}\mathbf{L}^T - \frac{2}{3}\text{tr}(\mathbf{D})\bar{\mathbf{B}} - \dot{\Gamma}\mathbf{A}, \text{ where } \mathbf{A} = \bar{\mathbf{B}} - \left[\frac{3}{\text{tr}(\bar{\mathbf{B}}^{-1})} \right] \mathbf{I} ,$$

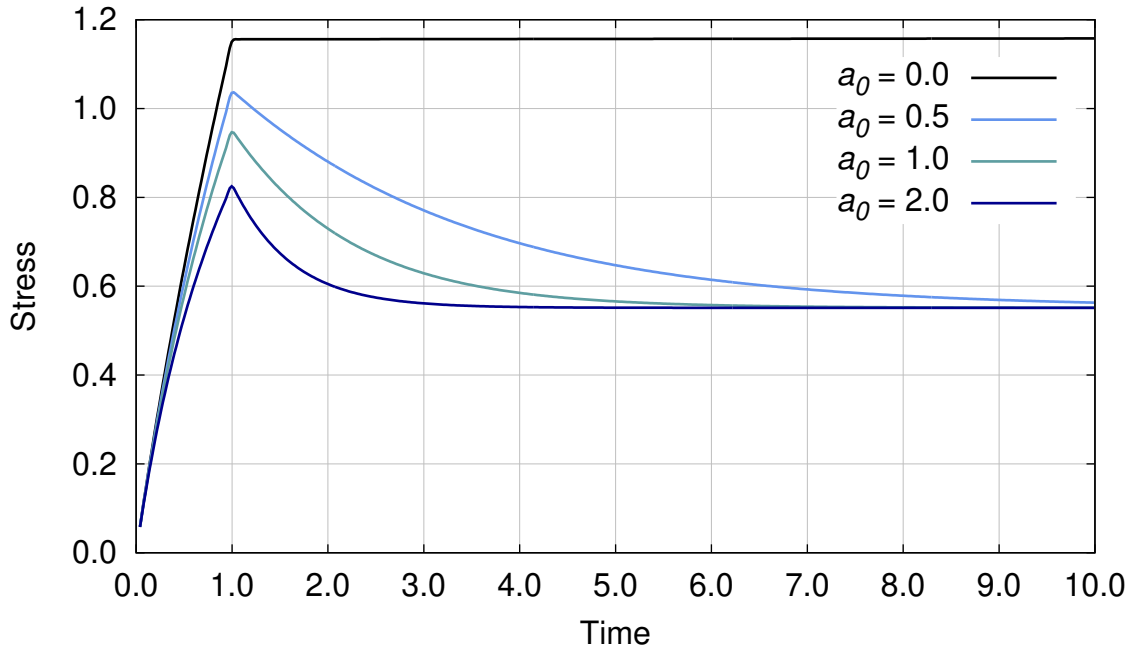

Figure M275-2. Influence of parameter a_0 on stress relaxation

where \mathbf{D} is the rate-of-deformation and $\dot{\Gamma}$ governs the inelastic deformation. The functional form of $\dot{\Gamma}$ is summarized in the following set of equations

$$\begin{aligned} \dot{\Gamma} &= \dot{\Gamma}_0 + \langle g \rangle \dot{\Gamma}_1 \\ \dot{\Gamma}_i &= a_i + b_i \dot{\epsilon}, \quad i = 0,1 \\ g &= 1 - \frac{\kappa}{\tilde{\gamma}} \end{aligned}$$

where

$$\begin{aligned} \langle g \rangle &= \max(0, g) \\ \dot{\epsilon} &= \sqrt{\frac{2}{3} \tilde{\mathbf{D}} : \tilde{\mathbf{D}}} \\ \tilde{\mathbf{D}} &= \mathbf{D} - \frac{1}{3} \text{tr}(\mathbf{D}) \mathbf{I} \\ \tilde{\gamma} &= \sqrt{\frac{3}{8} \tilde{\mathbf{B}} : \tilde{\mathbf{B}}} \\ \dot{\kappa} &= m \dot{\Gamma}_1 \langle g \rangle (\kappa_s - \kappa) \end{aligned}$$

A hyperelastic law with a strain energy potential for the distortional deformation given by

$$\psi(\alpha) = \frac{G}{2} (\alpha - 3)$$

yields a contribution to the deviatoric Cauchy stress of

$$\mathbf{s} = GJ^{-1} \tilde{\mathbf{B}} .$$

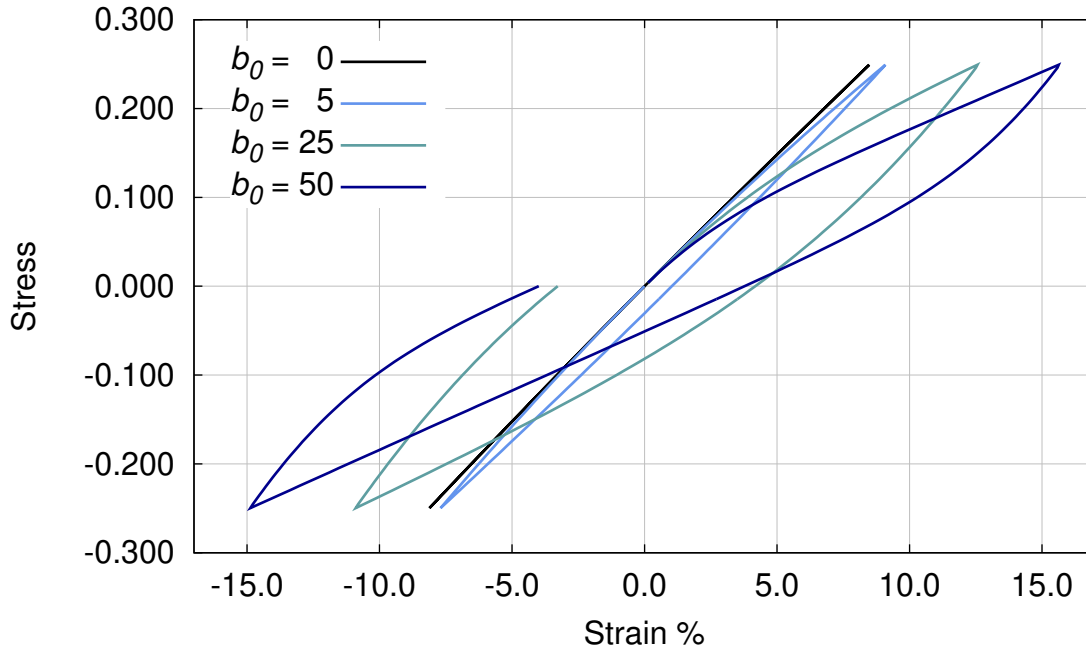

Figure M275-3. Influence of b_0 in cyclic loading

In uniaxial stress at constant total distortional rate of deformation $\pm \dot{\epsilon}$ (tension or compression), these equations can be reduced to scalar correspondents

$$\frac{\dot{\bar{b}}}{\bar{b}} = 2 \left(\pm \dot{\epsilon} - \dot{\Gamma} \frac{\bar{b}\sqrt{\bar{b}} - 1}{2\bar{b}\sqrt{\bar{b}} + 1} \right)$$

$$\tau = G \left(\bar{b} - \frac{1}{\sqrt{\bar{b}}} \right) \quad (\text{M275.1})$$

where \bar{b} is the component of $\bar{\mathbf{B}}$ in the direction of deformation and τ is the uniaxial Kirchhoff stress. The evolution of Γ follows the equations above with

$$\tilde{\gamma} = \frac{1}{2} \left| \bar{b} - 1/\sqrt{\bar{b}} \right|.$$

Even though analytical solutions may be out of reach, this would be the basis for estimating as well as interpreting the material parameters. Obviously the shear modulus G (SHEAR) provides the elastic deviatoric stiffness, for a purely elastic material just define one such parameter and leave out all the other parameters on the same card. If several cards are used, the effective elastic shear stiffness is the sum of the contributions from each of the corresponding HJR elements. An interesting observation is that the stress in a HJR element saturates to a value given by the solution of $\dot{\bar{b}}$ to

$$\bar{b}\sqrt{\bar{b}} \left(\pm 2 - \left\{ b_0 + b_1 + \frac{a_0 + a_1}{\dot{\epsilon}} \right\} \right) \pm 2\sqrt{\bar{b}}\kappa_s \left(b_1 + \frac{a_1}{\dot{\epsilon}} \right) + \left(\pm 1 + \left\{ b_0 + b_1 + \frac{a_0 + a_1}{\dot{\epsilon}} \right\} \right) = 0 \quad (\text{M275.2})$$

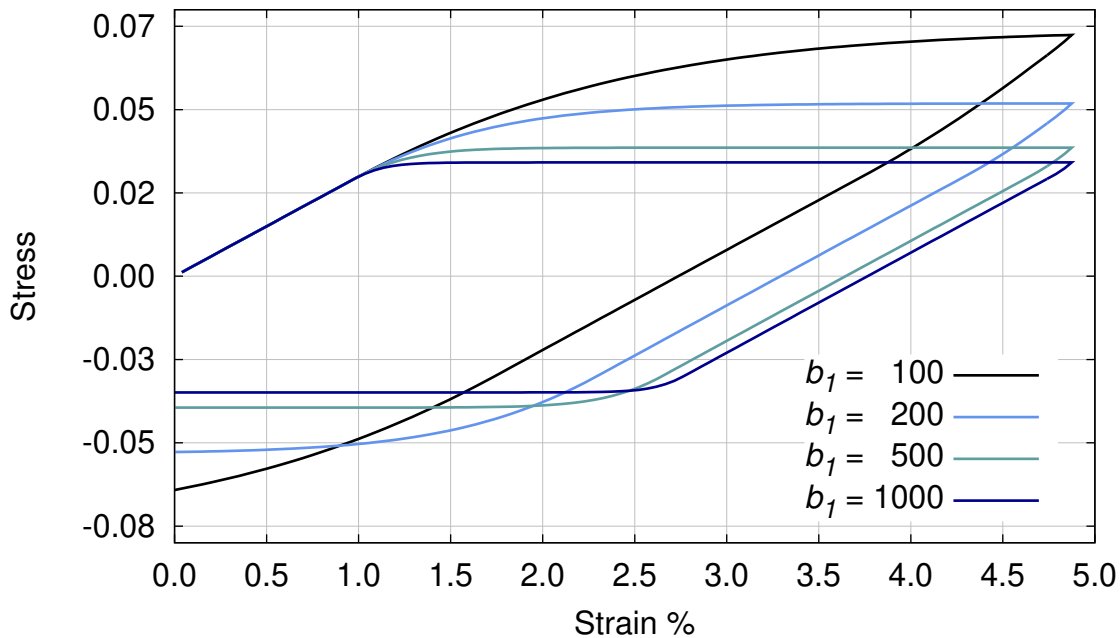

Figure M275-4. Effect of b_1 in cyclic loading

in tension (+) and compression (-), followed by application of (M275.1) above, assuming that

$$b_0 + b_1 + \frac{a_0 + a_1}{\dot{\epsilon}} > 2$$

in tension and

$$b_0 + b_1 + \frac{a_0 + a_1}{\dot{\epsilon}} > 1$$

in compression. This expression will be used in special cases below when examining each inelastic material parameter individually; the material parameters above are input on the HJR element cards as A0, B0, A1, B1 and KAPAS.

A Maxwell material is obtained by providing an element with a nonzero a_0 (A0) and with other parameters set to zero. This parameter should be interpreted as the viscoelastic relaxation coefficient determining the rate at which the stress relaxes to zero (see parameter BETA in *MAT_VISCOELASTIC). In Figure M275-2 a stress relaxation is shown for a strain controlled problem using two HJR elements and normalized material parameters using a bulk modulus of $K = 1$. For the first element $G = 0.5$ and for the other $G = 1$ while a_0 varies; all other parameters are zero. The engineering strain is ramped to 50% from $t = 0$ to $t = 1$ and then kept constant. The response is very similar to other viscoelastic models in LS-DYNA. Not surprisingly, a HJR element with $a_0 > 0$ (and $a_1 = b_1 = 0$) will always relax to zero stress, which follows from (M275.1) and (M275.2); thus the relaxed stress in this case comes from the purely elastic element. A general viscoelastic material can be obtained by putting several such HJR elements in parallel, in analogy to *MAT_GENERAL_VISCOELASTIC.

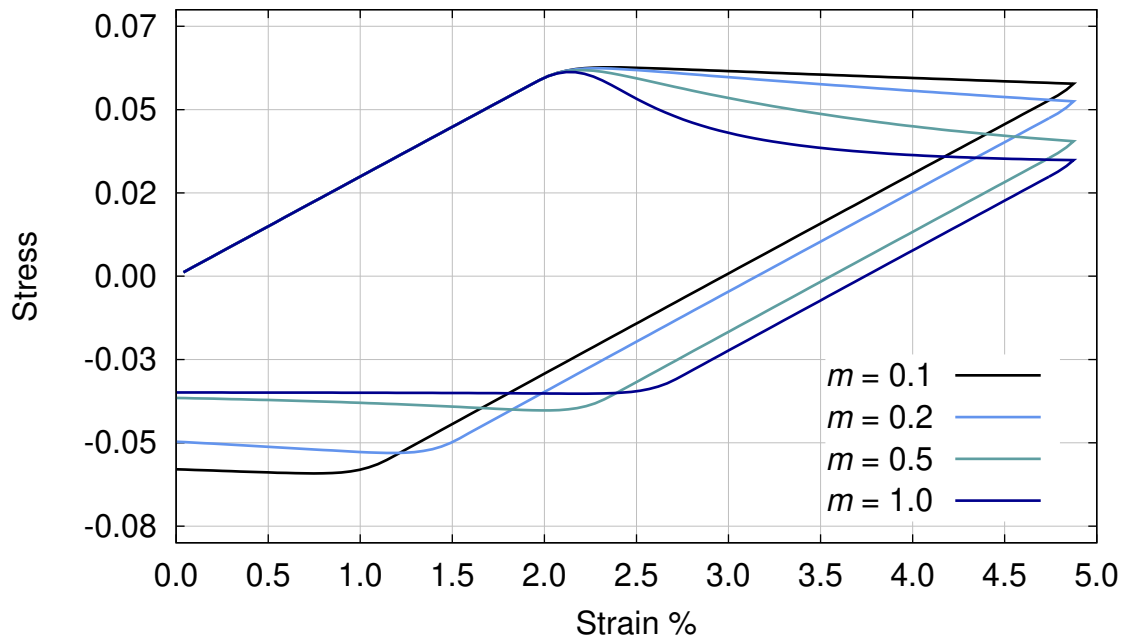

Figure M275-5. Softening response in cyclic loading for various values of m

For a nonzero b_0 (B0) with other parameters set to zero, a rate independent plastic response is obtained exhibiting zero yield stress, that is, inelastic strains develop immediately upon loading. From (M275.2) the value of b_0 determines the saturated stress value for the associated HJR element by (M275.1) and

$$\bar{b} = \left(\frac{b_0 \pm 1}{b_0 \mp 2} \right)^{2/3}$$

in tension (+) and compression (–), respectively. A smooth response is obtained that is characterized by hysteresis as shown in Figure M275-3. The same material parameters as in the previous example are used with the exception of varying b_0 instead of a_0 . The deformation is controlled by a cyclic Cauchy stress between -0.25 and 0.25 ; for larger b_0 a hysteresis is observed. It should however be mentioned that the hysteresis vanishes as $b_0 \rightarrow \infty$ as the stress for the second element saturates quickly to a small value, so it is not trivial to quantitatively estimate the amount of hysteresis for a given parameter setting and deformation.

Rate independent plasticity with a nonzero yield stress can be obtained by a nonzero b_1 (B1) in combination with parameters κ_0 (KAPA0), κ_s (KAPAS) and m (M). The yield stress in the sense of von Mises is given by

$$\sigma_Y = 2GJ^{-1}\kappa$$

from which κ is interpreted as the current yield strain. Here b_1 determines the amount of overstress through (M275.1) and (M275.2), requiring the solution of a non-trivial

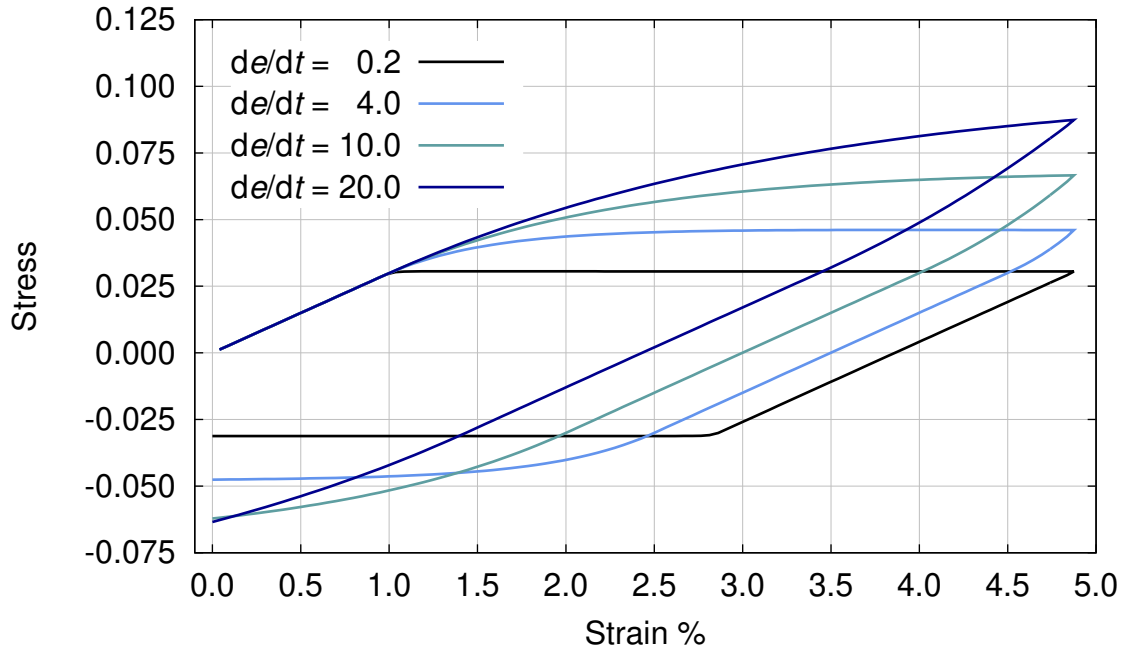

Figure M275-6. Strain rate dependence for $a_1 = 1000$ and $b_1 = 10$

polynomial equation. This is exemplified in Figure M275-4 using one HJR element with $K = 1, G = 1.5, \kappa_0 = \kappa_s = 0.01$ and $m = 0$. The engineering strain is ramped up to 5% and down to 0 and b_1 is varied with all other parameters zero; the response tends to an elastic-perfectly plastic as b_1 increases. The saturated stress value for $b_1 \rightarrow \infty$ can be calculated as

$$\bar{b} = \left[\left(\frac{1}{2} + \sqrt{\frac{1}{4} \mp \frac{8\kappa_s^3}{27}} \right)^{1/3} + \left(\frac{1}{2} - \sqrt{\frac{1}{4} \mp \frac{8\kappa_s^3}{27}} \right)^{1/3} \right]^2 \quad (\text{M275.3})$$

employing (M275.1).

Isotropic strain hardening ($\kappa_s > \kappa_0$) or softening ($\kappa_s < \kappa_0$) is obtained with $m > 0$; κ tends exponentially towards κ_s at a rate determined by m . Using $b_1 = 1000$ (meaning very little overstress), $\kappa_0 = 0.02$, and $\kappa_s = 0.01$ while varying m , the softening response in Figure M275-5 is obtained. The rate at which the element hardens is difficult to quantitatively estimate, but presumably it depends not only on m but also on b_1 . It is important to note however that for small to moderate b_1 the model appears to harden with $m = 0$, which is due to larger overstress. The hardening determined by m can be determined from a loading, unloading and reloading cycle to detect how the the yield strain κ changes; see Holtenstein et.al. [2013].

Finally, a_1 (A1) is the viscoplastic parameter determining how stress responds to change in strain rate. Its interpretation is very similar to that of a_0 ; stress increases with increasing loading rate and relaxes to the saturated stress value given by (M275.1) and (M275.2). In Figure M275-6 a rate dependency is illustrated for $K = 1, G = 1.5, \kappa_0 = \kappa_s = 0.01$ and

$m = 0$, where we have set $a_1 = 1000$ and $b_1 = 10$. The engineering strain rate varies from 0.2 to 20 and for small strain rates (M275.3) can be used for estimating the saturated stress, but in general (M275.2) must be used.

Putting several HJR elements in parallel can thus provide a fairly general combination of viscoelastic/viscoplastic response with isotropic hardening/softening, but this of course requires a rich test suite and a good way of estimating the material parameters. Presumably it is often sufficient to neglect some effects and work with only a subset of the material parameters.

For post-processing, the effective plastic strain in this model is defined as

$$\varepsilon_p = \sqrt{\frac{2}{3} \boldsymbol{\varepsilon}_p : \boldsymbol{\varepsilon}_p} ,$$

where

$$\boldsymbol{\varepsilon}_p = \boldsymbol{\varepsilon}_t - \boldsymbol{\varepsilon}_e$$

is a crude estimation of the difference between total and elastic strain. We set

$$\boldsymbol{\varepsilon}_t = \frac{1}{2J} \left[\mathbf{B} - \frac{1}{3} \text{tr}(\mathbf{B}) \mathbf{I} \right]$$

$$\boldsymbol{\varepsilon}_e = \frac{1}{2G} \left[\boldsymbol{\sigma} - \frac{1}{3} \text{tr}(\boldsymbol{\sigma}) \mathbf{I} \right]$$

where

$$\mathbf{B} = J^{-2/3} \mathbf{F} \mathbf{F}^T$$

and G here is the sum of all shear moduli defined on the HJR element cards. Note that this does not correspond to the traditional measure of effective plastic strain which should be accounted for when validating results.

***MAT_CHRONOLOGICAL_VISCOELASTIC**

This is Material Type 276. This material model provides a general viscoelastic Maxwell model having up to 6 terms in the Prony series expansion and is useful for modeling dense continuum rubbers and solid explosives. It is similar to Material Type 76 but allows the incorporation of aging effects on the material properties. Either the coefficients of the Prony series expansion or a relaxation curve may be specified to define the viscoelastic deviatoric and bulk behavior.

The material model can also be used with laminated shell with either an elastic or viscoelastic layer. To activate the laminated shell set the formulation flag on *CONTROL_-SHELL. With the laminated option a user defined integration rule is needed.

Card 1	1	2	3	4	5	6	7	8
Variable	MID	RO	BULK	PCF	EF	TREF	A	B
Type	A8	F	F	F	F	F	F	F

Relaxation Curve. If fitting is done from a relaxation curve, specify fitting parameters on this card, *otherwise* if constants are set on Viscoelastic Constant Cards *LEAVE THIS CARD BLANK*.

Card 2	1	2	3	4	5	6	7	8
Variable	LCID	NT	BSTART	TRAMP	LCIDK	NTK	BSTARTK	TRAMPK
Type	F	I	F	F	F	I	F	F

Viscoelastic Constant Cards. Up to 12 cards may be input. The next keyword ("*") card terminates this input. These cards are not needed if relaxation data is defined. The number of terms for the shear behavior may differ from that for the bulk behavior: simply insert zero if a term is not included. If an elastic layer is defined, only G_i and K_i need to be defined (note in an elastic layer only one card is needed).

Card 3	1	2	3	4	5	6	7	8
Variable	G_i	$BETA_i$	K_i	$BETA K_i$				
Type	F	F	F	F				

VARIABLE	DESCRIPTION
MID	Material identification. A unique number or label not exceeding 8 characters must be specified.
RO	Mass density
BULK	Elastic bulk modulus
PCF	Tensile pressure elimination flag for solid elements only. If set to unity, tensile pressures are set to zero.
EF	Elastic flag: EQ.0: layer is viscoelastic. EQ.1: layer is elastic.
TREF	Reference temperature for shift function (must be greater than zero)
A	Chronological coefficient $\alpha(t_a)$. See Remarks below.
B	Chronological coefficient $\beta(t_a)$. See Remarks below.
LCID	Load curve ID for deviatoric behavior if constants, G_i and β_i , are determined using a least squares fit. See Figure M76-1 for an example relaxation curve.
NT	Number of terms in shear fit. The default is 6. Fewer than NT terms will be used if the fit produces one or more negative shear moduli. Currently, the maximum number is 6.
BSTART	In the fit, β_1 is set to zero, β_2 is set to BSTART, β_3 is 10 times β_2 , β_4 is 10 times β_3 , and so on. If zero, BSTART is determined by an iterative trial and error scheme.
TRAMP	Optional ramp time for loading
LCIDK	Load curve ID for bulk behavior if constants, K_i , and β_{K_i} are determined via a least squares fit. See Figure M76-1 for an example relaxation curve.
NTK	Number of terms desired in bulk fit. The default is 6. Currently, the maximum number is 6.

VARIABLE	DESCRIPTION
BSTARTK	In the fit, β_{K_1} is set to zero, β_{K_2} is set to BSTARTK, β_{K_3} is 10 times β_{K_2} , β_{K_4} is 10 times β_{K_3} , and so on. If zero, BSTARTK is determined by an iterative trial and error scheme.
TRAMPK	Optional ramp time for bulk loading
G_i	Optional shear relaxation modulus for the i^{th} term
BETA <i>i</i>	Optional shear decay constant for the i^{th} term
K_i	Optional bulk relaxation modulus for the i^{th} term
BETA <i>Ki</i>	Optional bulk decay constant for the i^{th} term

Remarks:

The Cauchy stress, σ_{ij} , is related to the strain rate by

$$\sigma_{ij}(t) = -p\delta_{ij} + \int_0^t g_{ijkl}(t - \tau) \frac{\partial \varepsilon_{kl}(\tau)}{\partial \tau} d\tau$$

For this model, it is postulated that the mathematical form is preserved in the constitutive equation for aging; however two new material functions, $g'_0(t_a)$ and $g'_1(t_a, t)$ are introduced to replace g_0 and $g_1(t)$, which is expressed in terms of a Prony series as in material model 76, *MAT_GENERAL_VISCOELASTIC. The aging time is denoted by t_a .

$$\sigma_{ij}(t_a, t) = -p\delta_{ij} + \int_0^t g'_{ijkl}(t_a, t - \tau) \frac{\partial \varepsilon_{kl}(\tau)}{\partial \tau} d\tau$$

where

$$g'_{ijkl}(t_a, t) = \alpha(t_a) g_{ijkl}[\beta(t_a)t] .$$

Here $\alpha(t_a)$ and $\beta(t_a)$ are two new material properties that are functions of the aging time t_a . The material properties functions $\alpha(t_a)$ and $\beta(t_a)$ will be determined using experimental results. For determination of $\alpha(t_a)$ and $\beta(t_a)$, the above equations can be written in the following form

$$\begin{aligned} \log(\sigma_{ij} - p\delta_{ij})_{t_a, t} &= \log \alpha(t_a) + \log(\sigma_{ij} - p\delta_{ij})_{t_a=0, t \rightarrow \xi} \\ \log \xi &= \log \beta(t_a) + \log t \end{aligned}$$

Therefore, if one plots the stress as a function of time on log-log scales, with the vertical axis being the stress and the horizontal axis being the time, then the stress-relaxation curve for any aged time history can be obtained directly from the stress-relaxation curve at $t_a = 0$ by imposing a vertical shift and a horizontal shift on the stress-relaxation curves. The vertical shift and the horizontal shift are $\log \alpha(t_a)$ and $\log \beta(t_a)$ respectively.

*MAT_ADHESIVE_CURING_VISCOELASTIC

This is Material Type 277. It is useful for modeling adhesive materials during chemical curing. This material model provides a general viscoelastic Maxwell model having up to 16 terms in the Prony series expansion. It is similar to Material Type 76, but the viscoelastic properties not only depend on the temperature but also on an internal variable representing the state of cure for the adhesive. The kinematics of the curing process depend on temperature as well as on temperature rate and follow the Kamal model.

Card 1	1	2	3	4	5	6	7	8
Variable	MID	RO	K1	K2	C1	C2	M	N
Type	A	F	F	F	F	F	F	F

Card 2	1	2	3	4	5	6	7	8
Variable	CHEXP1	CHEXP2	CHEXP3	LCHEXP	LCTHEXP	R	TREFEXP	DOCREXP
Type	F	F	F	I	I	F	F	F

Card 3	1	2	3	4	5	6	7	8
Variable	WLTREF	WLFA	WLFB	LCGO	LCK0	IDOC	INCR	QCURE
Type	F	F	F	I	I	F	I	F

Viscoelastic Constant Cards. Up to 16 cards may be input. A keyword ("*") card terminates this input if fewer than 16 cards are used. The number of terms for the shear behavior may differ from that for the bulk behavior: simply insert zero if a term is not included.

Card 4	1	2	3	4	5	6	7	8
Variable	G_i	BETAG $_i$	K_i	BETAK $_i$				
Type	F	F	F	F				

VARIABLE	DESCRIPTION
MID	Material identification. A unique number or label must be specified (see *PART).
RO	Mass density
K1	Parameter k_1 for Kamal model
K2	Parameter k_2 for Kamal model
C1	Parameter c_1 for Kamal model
C2	Parameter c_2 for Kamal model
M	Exponent m for Kamal model
N	Exponent n for Kamal model
CHEXP1	Quadratic parameter γ_2 for chemical shrinkage
CHEXP2	Linear parameter γ_1 for chemical shrinkage
CHEXP3	Constant parameter γ_0 for chemical shrinkage
LCCHEXP	LCCHEXP is a load curve ID defining the coefficient for chemical shrinkage $\gamma(\alpha)$ as a function of the state of cure, α . If set, parameters CHEXP1, CHEXP2 and CHEXP3 are ignored. See Remark 1 below.
LCTHEXP	LCTHEXP is a load curve ID or table ID defining the coefficient of thermal expansion $\beta(\alpha, T)$ as a function of cure, α , and temperature, T . If referring to a load curve, parameter $\beta(T)$ is a function of temperature, T .
R	Gas constant, R , for Kamal model
TREFEXP	Reference temperature, T_0 , for secant form of thermal expansion. See Remark 1 below.
DOCREXP	Reference degree of cure, α_0 , for sequential form of chemical expansion. See Remark 1 below.
WLFTRF	Reference temperature for either the Arrhenius or Williams-Landel-Ferry shift function (must be greater than zero for the shift function). Set to zero (along with WLFA and WLFB) to not apply scaling. See Remark 2 .

VARIABLE	DESCRIPTION
WLFA	Coefficient for the Arrhenius and the Williams-Landel-Ferry shift functions. Set to zero (along with WLFTREF and WLFB) to not apply scaling. See Remark 2 .
WLFB	Coefficient for the Williams-Landel-Ferry shift function. Set to zero for the Arrhenius shift function or to not apply scaling (to not apply scaling also set WLFTREF and WLFA to zero). See Remark 2 .
LCG0	Load curve ID defining the instantaneous shear modulus, G_0 , as a function of state of cure
LCK0	Load curve ID defining the instantaneous bulk modulus, K_0 , as a function of state of cure
IDOC	Initial degree of cure, α_I
INCR	Switch between incremental and total stress formulation: EQ.0: Total form (default) EQ.1: Incremental form (recommended)
QCURE	Heat generation factor, relating the heat generated in one time step with the increment of the degree of cure in that step
G_i	Shear relaxation modulus for the i^{th} term for fully cured material
BETAG i	Shear decay constant for the i^{th} term for fully cured material
K_i	Bulk relaxation modulus for the i^{th} term for fully cured material.
BETAK i	Bulk decay constant for the i^{th} term for fully cured material

Remarks:

- Material Formulation.** Within this material formulation an internal variable α has been included to represent the degree of cure for the adhesive. The evolution equation for this variable is given by the Kamal model and reads

$$\frac{d\alpha}{dt} = \left(k_1 \exp\left(\frac{-c_1}{RT}\right) + k_2 \exp\left(\frac{-c_2}{RT}\right) \alpha^m \right) (1 - \alpha)^n .$$

The chemical reaction of the curing process results in a shrinkage of the material. The coefficient of the chemical shrinkage $\gamma(\alpha)$ can either be given by a load curve or by using the quadratic expression

$$\gamma(\alpha) = \gamma_2 \alpha^2 + \gamma_1 \alpha + \gamma_0 .$$

For positive values of the parameter LCCHEXP, a differential form is used to compute the chemical strains:

$$d\varepsilon^{\text{ch}} = \gamma(\alpha)d\alpha .$$

Otherwise a secant form defines the strains:

$$\varepsilon^{\text{ch}} = \gamma(\alpha)(\alpha - \alpha_0) - \gamma(\alpha_I)(\alpha_I - \alpha_0) .$$

Consequently, the definition of $\gamma(\alpha)$ as quadratic expression goes along the secant formulation.

Analogously, the thermal strains are either defined in a secant or differential form, depending on the load curve parameter LCTHEXP. For positive values of that parameter, the differential form is applied, otherwise the secant form is used. For the latter the reference temperature T_0 is identified with the input parameter TREFEXP. In both cases the coefficient of thermal expansion can be given as table depending on degree of cure and temperature.

Finally, the Cauchy stress, σ_{ij} , is related to the strain rate by

$$\sigma_{ij}(t) = \int_0^t g_{ijkl}(t - \tau) \frac{\partial \varepsilon_{kl}(\tau)}{\partial \tau} d\tau .$$

The relaxation functions $g_{ijkl}(t - \tau)$ are represented in this material formulation by up to 16 terms (not including the instantaneous modulus G_0) of the Prony series:

$$g(t, \alpha) = G_0(\alpha) - \sum_i G_i(\alpha) + \sum_i G_i(\alpha) e^{-\beta_i t} .$$

For the sake of simplicity, a constant ratio $G_i(\alpha)/G_0(\alpha)$ for all degrees of cure is assumed. Consequently, it suffices to define one term $G_0(\alpha)$ as a function of the degree of cure and further coefficients for the fully cured state of the adhesive:

$$g(t, \alpha) = G_0(\alpha) \left(1 - \sum_i \frac{G_{i,\alpha=1.0}}{G_{0,\alpha=1.0}} (1 - e^{-\beta_i t}) \right) .$$

2. **Temperature Effect on the Stress Relaxation.** A possible temperature effect on the stress relaxation (see [Remark 1](#)) is accounted for by the Williams-Landel-Ferry (WLF) shift function or the Arrhenius shift function. For details on this function, please see material formulation 76, *MAT_GENERAL_VISCOELASTIC. If all three values (WLF_TREF, WLF_A, and WLF_B) are nonzero, the WLF function is used; the Arrhenius function is used if WLF_B is zero; and no scaling is applied if all three values are zero.

*MAT_CF_MICROMECHANICS

This is Material Type 278 developed for draping and curing analysis of pre-impregnated (prepreg) carbon fiber sheets. This material model is a mixture of MAT_234 [Tabiei et. al.] and MAT_277. It was developed with the collaboration of Professor Tabiei from UC. MAT_234 provides the reorientation and locking phenomenon of fibers while MAT_277 provides the viscoelastic behavior of epoxy resin. Both the epoxy resin and the fiber orientation and deformation contribute to the overall stress.

Card Summary:

Card 1. This card is required.

MID	RO	E1	E2	G12	G23	EU	C
-----	----	----	----	-----	-----	----	---

Card 2. This card is required.

EKA	EUA	VMB	EKB	THL	TA	TH1	TH2
-----	-----	-----	-----	-----	----	-----	-----

Card 3. This card is required.

W	SPAN	THICK	H	AREA	E3	PR13	PR23
---	------	-------	---	------	----	------	------

Card 4. This card is required.

AOPT	A1	A2	A3	XP	YP	ZP	
------	----	----	----	----	----	----	--

Card 5. This card is required.

V1	V2	V3	D1	D2	D3		
----	----	----	----	----	----	--	--

Card 6. This card is required.

VYARN							
-------	--	--	--	--	--	--	--

Card 7. This card is required.

K1	K2	C1	C2	M	N		
----	----	----	----	---	---	--	--

Card 8. This card is required.

CHEXP1	CHEXP2	CHEXP3	LCCHEXP	LCTHEXP	R	TREF	DOCREF
--------	--------	--------	---------	---------	---	------	--------

Card 9. This card is required.

WLFTRF	WLFA	WLFB	LCG0	LCK0	IDOC	INCR	QCURE
--------	------	------	------	------	------	------	-------

Card 10. Up to 14 cards may be input. The next keyword ("*") card terminates this input.

<i>G_i</i>	BETAG _i	<i>K_i</i>	BETAK _i				
----------------------	--------------------	----------------------	--------------------	--	--	--	--

Data Card Definitions:

Card 1	1	2	3	4	5	6	7	8
Variable	MID	RO	E1	E2	G12	G23	EU	C
Type	A8	F	F	F	F	F	F	F

VARIABLE**DESCRIPTION**

MID	Material identification. A unique number or label not exceeding 8 characters must be specified.
RO	Mass density
E1	Young's modulus in the yarn's axial direction, E_1
E2	Young's modulus in the yarn's transverse direction, E_2
G12	Shear modulus of the yarns, G_{12}
G23	Transverse shear modulus
EU	Ultimate strain at failure
C	Coefficient of friction between the fibers

Card 2	1	2	3	4	5	6	7	8
Variable	EKA	EUA	VMB	EKB	THL	TA	THI1	THI2
Type	F	F	F	F	F	F	F	F

VARIABLE**DESCRIPTION**

EKA	Elastic constant of element "a"
-----	---------------------------------

VARIABLE	DESCRIPTION
EUA	Ultimate strain of element "a"
VMB	Damping coefficient of element "b"
EKB	Elastic constant of element "b"
THL	Yarn locking angle
TA	Transition angle of locking
THI1	Initial braid angle 1
THI2	Initial braid angle 2

Card 3	1	2	3	4	5	6	7	8
Variable	W	SPAN	THICK	H	AREA	E3	PR13	PR23
Type	F	F	F	F	F	F	F	F

VARIABLE	DESCRIPTION
W	Fiber width
SPAN	Span between the fibers
THICK	Real fiber thickness
H	Effective fiber thickness
AREA	Fiber cross-sectional area
E3	Young's modulus E_3 in "thickness" direction as defined by the 3 rd axis of the material coordinate system (solids only)
PR13	Transverse Poisson's ratio ν_{13} (solids only)
PR23	Transverse Poisson's ratio ν_{23} (solids only)

Card 4	1	2	3	4	5	6	7	8
Variable	AOPT	A1	A2	A3	XP	YP	ZP	
Type	F	F	F	F	F	F	F	

VARIABLE**DESCRIPTION**

AOPT

Material axes option (see *MAT_OPTION TROPIC_ELASTIC* for a more complete description):

EQ.0.0: locally orthotropic with material axes determined by element nodes 1, 2, and 4, as with **DEFINE_COORDINATE_NODES*.

EQ.1.0: locally orthotropic with material axes determined by a point in space and the global location of the element center; this is the *a*-direction.

EQ.2.0: globally orthotropic with material axes determined by vectors defined below, as with **DEFINE_COORDINATE_VECTOR*.

EQ.3.0: locally orthotropic material axes for each integration point determined by rotating the material axes about the element normal by an angle, B_i (see **PART_COMPOSITE*), from a line in the plane of the element defined by the cross product of the vector \mathbf{v} with the element normal.

EQ.4.0: locally orthotropic in cylindrical coordinate system with the material axes determined by a vector \mathbf{v} , and an originating point, \mathbf{p} , which define the centerline axis. This option is for solid elements only.

LT.0.0: the absolute value of AOPT is a coordinate system ID number (CID on **DEFINE_COORDINATE_NODES*, **DEFINE_COORDINATE_SYSTEM* or **DEFINE_COORDINATE_VECTOR*).

A1, A2, A3

Components of vector \mathbf{a} for AOPT = 2.0

XP, YP, ZP

Coordinates of point \mathbf{p} for AOPT = 1.0 and 4.0

Card 5	1	2	3	4	5	6	7	8
Variable	V1	V2	V3	D1	D2	D3		
Type	F	F	F	F	F	F		

VARIABLE**DESCRIPTION**

V1, V2, V3

Components of vector \mathbf{v} for AOPT = 3.0 and 4.0

D1, D2, D3

Components of vector \mathbf{d} for AOPT = 2.0

Card 6	1	2	3	4	5	6	7	8
Variable	VYARN							
Type	F							

VARIABLE**DESCRIPTION**

VYARN

Volume fraction of yarn

Card 7	1	2	3	4	5	6	7	8
Variable	K1	K2	C1	C2	M	N		
Type	F	F	F	F	F	F		

VARIABLE**DESCRIPTION**

K1

Parameter k_1 for Kamal model

K2

Parameter k_2 for Kamal model

C1

Parameter c_1 for Kamal model

C2

Parameter c_2 for Kamal model

M

Exponent m for Kamal model

N

Exponent n for Kamal model

Card 8	1	2	3	4	5	6	7	8
Variable	CHEXP1	CHEXP2	CHEXP3	LCCHEXP	LCTHEXP	R	TREF	DOCREF
Type	F	F	F	I	I	F	F	F

VARIABLE**DESCRIPTION**

CHEXP1	Quadratic parameter γ_2 for chemical shrinkage
CHEXP2	Quadratic parameter γ_1 for chemical shrinkage
CHEXP3	Quadratic parameter γ_0 for chemical shrinkage
LCCHEXP	Load curve ID to define the coefficient for chemical shrinkage $\gamma(\alpha)$ as a function of the state of cure α . If set, parameters CHEXP1, CHEXP2, and CHEXP3 are ignored.
LCTHEXP	Load curve ID or table ID defining the instantaneous coefficient of thermal expansion $\beta(\alpha, T)$ as a function of cure α and temperature T . If referring to a load curve, parameter $\beta(T)$ is a function of temperature T .
R	Gas constant R for Kamal model
TREF	Reference temperature T_0 for secant form of thermal expansion
DOCREF	Reference degree of cure α_0 for sequential form of chemical expansion

Card 9	1	2	3	4	5	6	7	8
Variable	WLF TREF	WLF A	WLF B	LCG0	LCK0	IDOC	INCR	QCURE
Type	F	F	F	I	I	F	I	F

VARIABLE**DESCRIPTION**

WLF TREF	Reference temperature for WLF shift function
WLF A	Parameter A for WLF shift function

VARIABLE	DESCRIPTION
WLFB	Parameter B for WLF shift function
LCG0	Load curve ID defining the instantaneous shear modulus G_0 as a function of state of cure
LCK0	Load curve ID defining the instantaneous bulk modulus K_0 as a function of state of cure
IDOC	Initial degree of cure
INCR	Flag for stress formulation: EQ.0: total formulation (default) EQ.1: incremental formulation (recommended)
QCURE	Heat generation factor, relating the heat generated in one time step with the increment of the degree of cure in that step

Viscoelastic Constant Cards. Up to 14 cards may be input. A keyword (“*”) card terminates this input if fewer than 14 cards are used. The number of terms for the shear behavior may differ from that for the bulk behavior: simply insert zero if a term is not included.

Card 10	1	2	3	4	5	6	7	8
Variable	G_i	BETAG i	K_i	BETAK i				
Type	F	F	F	F				

VARIABLE	DESCRIPTION
G_i	Shear relaxation modulus for the i^{th} term for fully cured material
BETAG i	Shear decay constant for the i^{th} term for fully cured material
K_i	Bulk relaxation modulus for the i^{th} term for fully cured material
BETAK i	Bulk decay constant for the i^{th} term for fully cured material

***MAT_COHESIVE_PAPER**

This is Material Type 279. This is a cohesive model for paper materials and can be used only with cohesive element formulations; see the variable ELFORM in *SECTION_SOLID and *SECTION_SHELL.

Card 1	1	2	3	4	5	6	7	8
Variable	MID	RO	ROFLG	INTFAIL	ENO	ET0	EN1	ET1
Type	A	F	F	F	F	F	F	F
Default	none	none	none	none	none	none	none	none

Card 2	1	2	3	4	5	6	7	8
Variable	T0N	DN	T1N	T0T	DT	T1T	E3C	CC
Type	F	F	F	F	F	F	F	F
Default	none	none	none	none	none	none	none	none

Card 3	1	2	3	4	5	6	7	8
Variable	ASIG	BSIG	CSIG	FAILN	FAILT			
Type	F	F	F	F	F			
Default	none	none	none	none	none			

VARIABLE**DESCRIPTION**

MID Material identification. A unique number or label must be specified (see *PART).

RO Mass density

VARIABLE	DESCRIPTION
ROFLG	<p>Flag for whether density is specified per unit area or volume:</p> <p>EQ.0: Specifies density per unit volume (default)</p> <p>EQ.1: Specifies the density is per unit area for controlling the mass of cohesive elements with an initial volume of zero.</p>
INTFAIL	<p>The number of integration points required for the cohesive element to be deleted. The value of INTFAIL may range from 1 to 4 with 1 the recommended value.</p> <p>LT.0.0: Employs a Newton-Cotes integration scheme. The element will be deleted when INTFAIL integration points have failed.</p> <p>EQ.0.0: Employs a Newton-Cotes integration scheme. The element will <i>not</i> be deleted even if it satisfies the failure criterion.</p> <p>GT.0.0: Employs a Gauss integration scheme. The element will be deleted when INTFAIL integration points have failed.</p>
EN0	<p>The initial tensile stiffness (units of stress / length) normal to the plane of the cohesive element.</p>
EN1	<p>The final tensile stiffness (units of stress / length) normal to the plane of the cohesive element.</p>
ET0	<p>The initial stiffness (units of stress / length) tangential to the plane of the cohesive element.</p>
ET1	<p>The final stiffness (units of stress / length) tangential to the plane of the cohesive element.</p>
T0N	<p>Peak tensile traction in normal direction.</p>
DN	<p>Scale factor (unit of length).</p>
T1N	<p>Final tensile traction in normal direction.</p>
T0T	<p>Peak tensile traction in tangential direction. If negative, the absolute value indicates a curve with respect to the normal traction.</p>
DT	<p>Scale factor (unit of length). If negative, the absolute value indicates a curve with respect to the normal stress.</p>

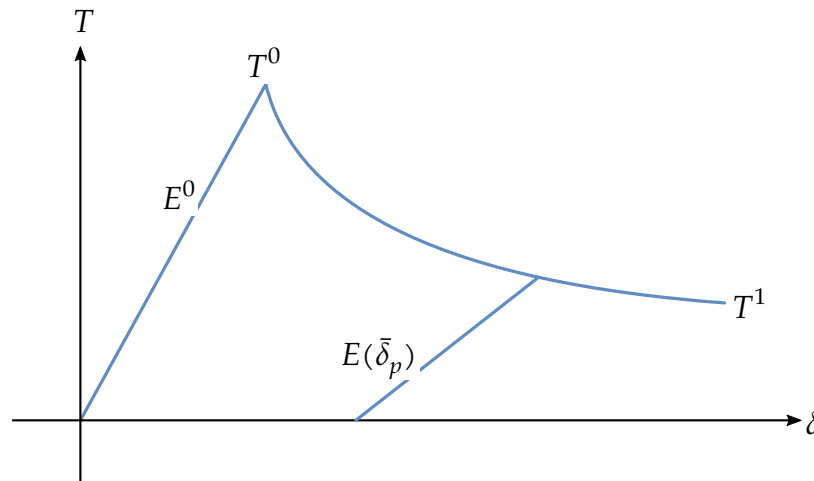

Figure M279-1. Traction-separation law

VARIABLE	DESCRIPTION
T1T	Final traction in tangential direction. If negative, the absolute value indicates a curve with respect to the normal traction.
E3C	Elastic parameter in normal compression.
CC	Elastic parameter in normal compression.
ASIG	Plasticity hardening parameter in normal compression.
BSIG	Plasticity hardening parameter in normal compression.
CSIG	Plasticity hardening parameter in normal compression.
FAILN	Maximum effective separation distance in normal direction. Beyond this distance failure occurs.
FAILT	Maximum effective separation distance in tangential direction. Beyond this distance failure occurs.

Remarks:

In this elastoplastic cohesive material, the normal and tangential directions are treated separately, but can be connected by expressing the in-plane traction parameters as functions of the normal traction. In the normal direction the material uses different models in tension and compression.

Normal tension:

Assume the total separation is an additive split of the elastic and plastic separation

$$\delta = \delta_e + \delta_p .$$

In normal tension ($\delta_e > 0$) the elastic traction is given by

$$T = E\delta_e = E(\delta - \delta_p) \geq 0,$$

where the tensile normal stiffness

$$E = (E_N^0 - E_N^1) \exp\left(\frac{-\bar{\delta}_p}{\delta_N}\right) + E_N^1 ,$$

depends on the effective plastic separation in the normal direction

$$\bar{\delta}_p = \int |d\delta_p| .$$

Yield traction for tensile loads in normal direction is given by

$$T_{\text{yield}} = (T_N^0 - T_N^1) \exp\left(\frac{-\bar{\delta}_p}{\delta_N}\right) + T_N^1 \geq 0,$$

and yielding occurs when $T > T_{\text{yield}} \geq 0$. The above elastoplastic model gives the traction-separation law depicted in [Figure M279-1](#).

Normal compression:

In normal compression the elastic traction is

$$T = E_3^c [1 - \exp(-C_c \delta_e)] \leq 0,$$

and the yield traction is

$$T_{\text{yield}} = -[A_\sigma + B_\sigma \exp(-C_\sigma \bar{\delta}_p)] \leq 0,$$

with yielding if $T < T_{\text{yield}} \leq 0$.

Tangential traction:

Assume the total separation is an additive split of the elastic and plastic separation in each in-plane direction

$$\delta_i = \delta_e^i + \delta_p^i, \quad i = 1, 2.$$

The elastic traction is given by

$$T_i = E\delta_e^i = E(\delta_i - \delta_p^i),$$

where the tensile normal stiffness

$$E = (E_T^0 - E_T^1) \exp\left(\frac{-\bar{\delta}_p}{\delta_T}\right) + E_T^1,$$

depends on the effective plastic separation

$$\bar{\delta}_p = \int d\delta_p, \quad d\delta_p = \sqrt{(d\delta_p^1)^2 + (d\delta_p^2)^2}.$$

Yield traction is given by

$$T_{\text{yield}} = (T_T^0 - T_T^1) \exp\left(\frac{-\bar{\delta}_p}{\delta_T}\right) + T_T^1,$$

and yielding occurs when

$$T_1^2 + T_2^2 - T_{\text{yield}}^2 \geq 0.$$

The plastic flow increment follows the flow rule

$$d\delta_p^i = \frac{T_i}{\sqrt{T_1^2 + T_2^2}} d\delta_p.$$

The above elastoplastic model gives the traction-separation law depicted in [Figure M279-1](#).

History variables

This material uses five history variables. Effective separation in the tangential direction is saved as Effective Plastic Strain. History variable 1 and 2 indicates the plastic separation in each tangential direction. Effective plastic separation and plastic separation in the normal direction are saved as history variable 3 and 4, respectively.

***MAT_GLASS_{OPTION}**

Available options include:

<BLANK>

STOCHASTIC

This is Material Type 280. It is a smeared fixed crack model with a selection of different brittle, stress-state dependent failure criteria such as Rankine, Mohr-Coulomb, or Drucker-Prager. The model incorporates up to 2 (orthogonal) cracks per integration point, simultaneous failure over element thickness, and crack closure effects. It is available for shell elements and thick shell types 1, 2 and 6. It is only available for explicit analysis.

The STOCHASTIC keyword option allows spatially varying tensile strength behavior. See *DEFINE_STOCHASTIC_VARIATION for additional information.

Card 1	1	2	3	4	5	6	7	8
Variable	MID	RO	E	PR			IMOD	ILAW
Type	A	F	F	F			F	F

Card 2	1	2	3	4	5	6	7	8
Variable	FMOD	FT	FC	AT	BT	AC	BC	FTSCL
Type	F	F	F	F	F	F	F	F

Card 3	1	2	3	4	5	6	7	8
Variable	SFSTI	SFSTR	CRIN	ECRCL	NCYCR	NIPF		
Type	F	F	F	F	F	F		

Optional card.

Card 4	1	2	3	4	5	6	7	8
Variable	EPSCR	ENGCR	RADCRT	RATENL	RFILTF	FRACEN		
Type	F	F	F	F	F	F		

VARIABLE**DESCRIPTION**

MID	Material identification. A unique number or label must be specified (see *PART).
RO	Mass density, ρ
E	Young's modulus, E
PR	Poisson's ratio, ν
IMOD	Flag to choose degradation procedure when critical stress is reached: EQ.0.0: Softening in NCYCR load steps. Define SFSTI, SFSTR, and NCYCR (default). EQ.1.0: Damage model for softening. Define ILAW, AT, BT, AC, and BC.
ILAW	Flag to choose damage evolution law if IMOD = 1.0 (see Remark 5): EQ.0.0: Same damage evolution for tensile and compressive failure (default) EQ.1.0: Different damage evolution for tensile failure and compressive failure.
FMOD	Flag to choose between failure criteria (see Remark 1): EQ.0.0: Rankine maximum stress (default) EQ.1.0: Mohr-Coulomb EQ.2.0: Drucker-Prager EQ.10.0: Rankine with modified compressive failure EQ.11.0: Mohr-Coulomb with modified compressive failure EQ.12.0: Drucker-Prager with modified compressive failure

VARIABLE	DESCRIPTION
FT	<p>Tensile strength, f_t.</p> <p>GT.0.0: Constant value</p> <p>LT.0.0: Load curve ID = FT , which gives tensile strength as a function of effective strain rate (RFILTF is recommended). If used with FTSCCL > 0, FT specifies a curve for tensile strength vs. strain rate, and FTSCCL scales the strength values from that curve as long as the material is intact. If cracked, neighbors get non-scaled values from that curve. RATENL is set to zero in that case.</p>
FC	Compressive strength, f_c .
AT	Tensile damage evolution parameter α_t . Can be interpreted as the residual load carrying capacity ratio for tensile failure ranging from 0 to 1.
BT	Tensile damage evolution parameter, β_t . It controls the softening velocity for tensile failure.
AC	Compressive damage evolution parameter, α_c . Can be interpreted as the residual load carrying capacity ratio for compressive failure ranging from 0 to 1.
BC	Compressive damage evolution parameter β_c . It controls the softening velocity for compressive failure.
FTSCL	<p>Scale factor for the tensile strength (default = 1.0):</p> $FT_{\text{mod}} = \text{FTSCL} \times FT$ <p>If RATENL = 0.0 (see Card 4), then the tensile strength drops to its original value, FT, as soon as the first crack happens in the associated part. In this case, FTSCL > 1.0 can be helpful to model high force peaks in impact events.</p> <p>If RATENL \neq 0.0, then, when a crack forms in a neighboring element, the tensile strength for an element is evaluated depending on the smoothed effective strain rate (see Remark 7).</p>
SFSTI	Scale factor for stiffness after failure. For example, SFSTI = 0.001 means that stiffness is reduced to 0.1% of the elastic stiffness at failure.
SFSTR	Scale factor for stress in case of failure. For example, SFSTR = 0.01 means that stress is reduced to 1% of the failure stress at failure.
ICRIN	Flag for crack strain initialization:

VARIABLE	DESCRIPTION
	EQ.0.0: Initial crack strain is strain at failure (default). EQ.1.0: Initial crack strain is zero.
ECRCL	Crack strain necessary to reactivate certain stress components after crack closure
NCYCR	Number of cycles in which the stress is reduced to SFSTR × failure stress
NIPF	Number of failed through thickness integration points needed to fail <i>all</i> through thickness integration points for IMOD = 0
EPSCR	Critical value to trigger element deletion. This can be useful to get rid of highly distorted elements. GT.0.0: EPSCR is effective critical strain. LT.0.0: EPSCR is critical crack opening displacement.
ENGCR	Critical energy for nonlocal failure criterion; see Remark 6 .
RADCRT	Critical radius for nonlocal failure criterion; see Remark 6 .
RATENL	Quasi-static strain rate threshold variable which activates a non-local, strain rate dependent tensile strength adaption; see Remark 7 .
RFILTF	Smoothing factor on the effective strain rate for the evaluation of the current tensile strength if RATENL > 0.0; see Remark 7 . $\dot{\epsilon}_n^{\text{avg}} = \text{RFILTF} \times \dot{\epsilon}_{n-1}^{\text{avg}} + (1 - \text{RFILTF}) \times \dot{\epsilon}_n$
FRACEN	Fracture energy (units of stress × length). An alternative orthotropic damage model with linear softening is invoked with this option. Values smaller than $0.5 \times f_t \times \frac{f_t}{E} \times l_e$ (element size) lead to immediate failure. This is the area under the elastic stress-displacement line until f_t is reached. Only larger values result in actual residual energy after crack initiation. Variables SFSTI, SFSTR, and NCYCR are ignored with this option. You can specify a spatially-varying scale factor for FRACEN by setting history variable #14 with *INITIAL_STRESS_SHELL.

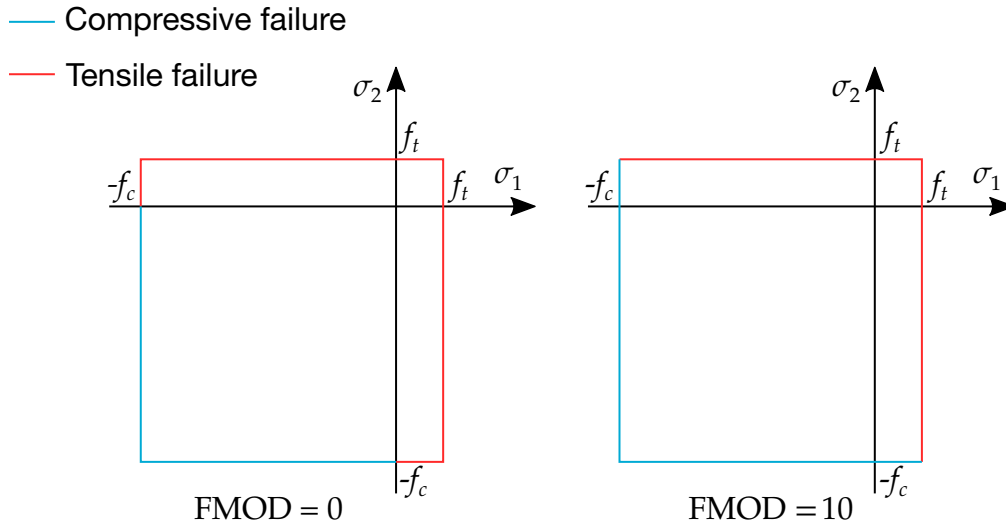

Figure M280-1. Rankine failure criterion. With FMOD = 10, the form of the failure criterion does not change but what is considered compressive failure is modified.

Remarks:

1. **Plane Stress Failure Criteria.** The underlying material behavior before failure is isotropic, small strain linear elasticity with Young’s modulus, E , and Poisson’s ratio, ν . Asymmetric (tension-compression dependent) failure happens as soon as one of the following plane stress failure criteria is violated.

a) *Rankine Maximum Stress.* For FMOD = 0, a maximum stress criterion (Rankine) is used where principal stresses, σ_1 and σ_2 , are bound by tensile strength, f_t , and compressive strength, f_c , as follows:

$$-f_c < \{\sigma_1, \sigma_2\} < f_t$$

b) *Mohr-Coulomb.* With FMOD = 1, the Mohr-Coulomb criterion with expressions in four different categories is used:

$$\sigma_1 > 0 \text{ and } \sigma_2 > 0: \quad \max\left(\frac{\sigma_1}{f_t}, \frac{\sigma_2}{f_t}\right) < 1$$

$$\sigma_1 < 0 \text{ and } \sigma_2 < 0: \quad \max\left(-\frac{\sigma_1}{f_c}, -\frac{\sigma_2}{f_c}\right) < 1$$

$$\sigma_1 > 0 \text{ and } \sigma_2 < 0: \quad \frac{\sigma_1}{f_t} - \frac{\sigma_2}{f_c} < 1$$

$$\sigma_1 < 0 \text{ and } \sigma_2 > 0: \quad -\frac{\sigma_1}{f_c} + \frac{\sigma_2}{f_t} < 1$$

c) *Drucker-Prager*. For FMOD = 2, the plane stress Drucker-Prager criterion is given by:

$$\frac{1}{2f_c} \left[\left(\frac{f_c}{f_t} - 1 \right) (\sigma_1 + \sigma_2) + \left(\frac{f_c}{f_t} + 1 \right) \sqrt{\sigma_1^2 + \sigma_2^2 - \sigma_1 \sigma_2} \right] < 1$$

The modified versions, FMOD = 10, 11, 12, change what is considered tensile and compressive failure. The form of the failure stays the same for each type. In each case, a line with slope $-f_c/f_t$ distinguishes the difference between the two types of failure. See [Figure M280-1](#) for an example of how the tensile and compressive failure are modified for the Rankine failure criterion.

2. **Crack Formation.** As soon as failure happens in the tensile regime, a crack occurs perpendicular to the maximum principal stress direction. That means a crack coordinate system is set up and stored, defined by a relative angle with respect to the element coordinate system. Appropriate stress and stiffness tensor components (e.g. normal to the crack) are reduced according to SFSTR and SFSTI if IMOD = 0. The stress reduction takes place in a period of NCYCR time step cycles. For IMOD = 1.0 the stress and stiffness tensor are reduced by a damage model (see [Remark 5](#)). A second crack orthogonal to the first crack is possible which can open and close independently from the first one, further reducing the element stiffness.
3. **Crack Closure.** To deal with crack closure, the current strain in principal stress direction is stored as initial crack strain (ICRIN = 0, default) or the initial crack strain is set to zero (ICRIN = 1). After failure, the crack strain is tracked, so that later crack closure will be detected. If that is the case, appropriate stress and stiffness tensor components (e.g. compressive) are reactivated so that e.g. under pressure a load could be carried and cause a nonzero stress perpendicular to the crack.
4. **Number of Failed Integration Points.** If the critical number of failed integration points (NIPF) in one element is reached, all integration points over the element thickness fail as well. The default value of NIPF=1 resembles the fact, that a crack in a glass plate immediately runs through the thickness.
5. **Damage Model.** Starting with the release of LS-DYNA version R10, a damage model for stress and stiffness softening can be activated with IMOD = 1. The corresponding evolution law for ILAW = 0 is given by:

$$D = \begin{cases} 0 & \text{for } \kappa \leq \kappa^0 \\ 1 - \frac{\kappa^0}{\kappa} \left(1 - \alpha_{t,c} + \alpha_{t,c} e^{-\beta_{t,c}(\kappa - \kappa^0)} \right) & \text{otherwise} \end{cases}$$

meaning tensile and compressive failure are treated in the same fashion.

However, with ILAW = 1 the damage evolution for tensile failure is given by:

$$D = \begin{cases} 0 & \text{for } \kappa \leq \kappa^0 \\ 1 - \frac{\kappa^0}{\kappa} (1 - \alpha_t + \alpha_t e^{-\beta_t(\kappa - \kappa^0)}) & \text{otherwise} \end{cases}$$

while damage for compressive failure evolves as (more delayed stress reduction):

$$D = \begin{cases} 0 & \text{for } \kappa \leq \kappa^0 \\ 1 - \frac{\kappa^0}{\kappa} (1 - \alpha_c) - \alpha_c e^{-\beta_c(\kappa - \kappa^0)} & \text{otherwise} \end{cases}$$

6. **Nonlocal Failure.** A nonlocal failure criterion which is mainly intended for windshield impact can be defined using ENGCRIT and RADCRT. The same procedure is used as in *MAT_ADD_EROSION; see [Remark 1i](#) there.
7. **Strain Rate Dependent, Nonlocal Tensile Strength.** If RATENL > 0.0, all elements in the appropriate part are initialized with a tensile strength of FTSCl × FT. If one integration point in an element fails, then the tensile strength in the neighboring elements is set to \widetilde{FT} where

$$\widetilde{FT} = \begin{cases} FT & \text{if } \dot{\epsilon}^{avg} \leq RATENL \\ FT + (FTSCL \times FT - FT) \frac{\ln\left(\frac{\dot{\epsilon}^{avg}}{RATENL}\right)}{\ln\left(\frac{\dot{\epsilon}^{max}}{RATENL}\right)} & \text{if } RATENL < \dot{\epsilon}^{avg} < \dot{\epsilon}^{max} \\ FTSCL \times FT & \text{if } \dot{\epsilon}^{avg} > \dot{\epsilon}^{max} \end{cases}$$

Here $\dot{\epsilon}^{max} = 10^9 \times RATENL$. See [Figure M280-2](#) for a plot of this tensile strength as a function of average strain rate. The average strain rate in this case is calculated as:

$$\dot{\epsilon}_n^{avg} = RFILTF \times \dot{\epsilon}_{n-1}^{avg} + (1 - RFILTF) \times \dot{\epsilon}_n$$

where n is the time step.

8. **Element based (or stochastically varied) tensile strength.** You can define a spatially varying tensile strength with history variable #13 which is a scale factor on the strength. The history variable #13 value can be filled with *INITIAL_STRESS_SHELL or can come from *DEFINE_STOCHASTIC_VARIATION.

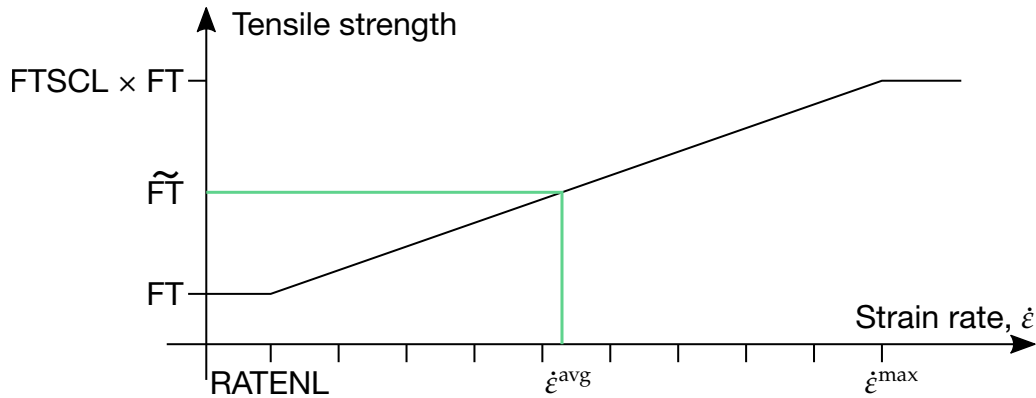

Figure M280-2. Modified tensile strength of elements neighboring an element that has at least one failed integration point as a function of strain rate when $RATENL > 0.0$. $\dot{\epsilon}^{max} = 10^9 \times RATENL$.

9. **History Variables.** This material has the following additional history variables that can be output to the d3plot file.

History Variable #	Description
1	Crack flag: EQ.0: No crack EQ.1: One crack EQ.2: Two cracks EQ.-1: Failed under compression
2	Direction of 1 st principle stress as angle in radians with respect to the element direction. The shell normal defines the positive angle direction. The 1 st crack direction is perpendicular to the direction of 1 st principle stress.
3	Angle in radians that defines the orthogonal to the 2 nd crack direction (with respect to the element direction).
4	Failure criterion value, see Remark 1
7	Current tensile strength value
8	Effective strain rate (if $FT < 0$ or $RATENL > 0$ is used)
9	Crack opening displacement (1 st crack)

History Variable #	Description
10	Time to failure
11	Damage in 1 st crack direction (only with FRACEN > 0)
12	Damage in 2 nd crack direction (only with FRACEN > 0)
13	Scale factor for tensile strength
14	Scale factor for fracture energy

***MAT_SHAPE_MEMORY_ALLOY**

This is Material Type 291, a micromechanics-inspired constitutive model for shape-memory alloys that accounts for initiation and saturation of phase. This model is based on Kelly, Stebner, Bhattacharya (2016) and is available for solid elements only.

Card Summary:

Card 1. This card is required.

MID	RHO	EM	EA	PRM	PRA	AOPT	STYPE
-----	-----	----	----	-----	-----	------	-------

Card 2. This card is required.

CPM	CPA	LH	TC	TMF	TMS	TAS	TAF
-----	-----	----	----	-----	-----	-----	-----

Card 3. This card is required.

A1I	A2I	BI	CI	KI	MI	KL	ML
-----	-----	----	----	----	----	----	----

Card 4. This card is required.

A1S	A2S	BS	CS	KS	MS		
-----	-----	----	----	----	----	--	--

Card 5. This card is required.

DOL	DOM						
-----	-----	--	--	--	--	--	--

Card 6. This card is required.

XP	YP	ZP	A1	A2	A3	MACF	
----	----	----	----	----	----	------	--

Card 7. This card is required.

V1	V2	V3	D1	D2	D3	BETA	REF
----	----	----	----	----	----	------	-----

Card 8.1. This card is included if STYPE = 1.

N11	N22	N33	N44	N55	N66	N12	N23
-----	-----	-----	-----	-----	-----	-----	-----

Card 8.2. This card is included if STYPE = 1.

N34	N45	N56	N13	N24	N35	N46	N14
-----	-----	-----	-----	-----	-----	-----	-----

Card 8.3. This card is included if STYPE = 1.

N25	N36	N15	N26	N16			
-----	-----	-----	-----	-----	--	--	--

Data Card Definitions:

Card 1	1	2	3	4	5	6	7	8
Variable	MID	RHO	EM	EA	PRM	PRA	AOPT	STYPE
Type	A	F	F	F	F	F	I	I

VARIABLE**DESCRIPTION**

MID	Material identification. A unique number or label must be specified (see *PART).
RHO	Mass density
EM	Martensite Young's modulus
EA	Austenite Young's modulus
PRM	Martensite Poisson's ratio
PRA	Austenite Poisson's ratio
AOPT	Material axes option (see MAT_OPTIONTROPIC_ELASTIC, particularly the Material Directions section, for details): <ul style="list-style-type: none"> EQ.0.0: Locally orthotropic with material axes determined by element nodes 1, 2, and 4, as with *DEFINE_COORDINATE_NODES. EQ.1.0: Locally orthotropic with material axes determined by a point, P, in space and the global location of the element center; this is the a-direction. EQ.2.0: Globally orthotropic with material axes determined by vectors defined below, as with *DEFINE_COORDINATE_VECTOR

VARIABLE

DESCRIPTION

EQ.3.0: Locally orthotropic material axes determined by a vector \mathbf{v} and the normal vector to the plane of the element. The plane of a solid element is the midsurface between the inner surface and outer surface defined by the first four nodes and the last four nodes of the connectivity of the element, respectively. Thus, AOPT = 3 is only available for hexahedrons. \mathbf{a} is determined by taking the cross product of \mathbf{v} with the normal vector, \mathbf{b} is determined by taking the cross product of the normal vector with \mathbf{a} , and \mathbf{c} is the normal vector. Then \mathbf{a} and \mathbf{b} are rotated about \mathbf{c} by an angle BETA. BETA may be set in the keyword input for the element or in the input for this keyword. Note that the material axes may be switched depending on the choice of MACF. The switch may occur before or after applying BETA depending on the value of MACF.

EQ.4.0: Locally orthotropic in a cylindrical coordinate system with the material axes determined by a vector \mathbf{v} , and an originating point, P , which define the centerline axis.

LT.0.0: The absolute value of AOPT is a coordinate system ID number (CID on *DEFINE_COORDINATE_OPTION).

STYPE

Initiation/saturation surface type (see Remark 1):

EQ.0: Uses strain invariants (default)

EQ.1: Uses principal strains

Card 2	1	2	3	4	5	6	7	8
Variable	CPM	CPA	LH	TC	TMF	TMS	TAS	TAF
Type	F	F	F	F	F	F	F	F

VARIABLE

DESCRIPTION

CPM Martensite volumetric heat capacity (density times specific heat capacity)

CPA Austenite volumetric heat capacity (density times specific heat capacity)

VARIABLE	DESCRIPTION
LH	Volumetric latent heat of transformation (density times specific latent heat)
TC	Thermodynamic temperature
TMF	Martensite finish temperature, optional; see Remark 2 .
TMS	Martensite start temperature, optional; see Remark 2 .
TAS	Austenite start temperature, optional; see Remark 2 .
TAF	Austenite finish temperature, optional; see Remark 2 .

Card 3	1	2	3	4	5	6	7	8
Variable	A1I	A2I	BI	CI	KI	MI	KL	ML
Type	F	F	F	F	F	F	F	F

VARIABLE	DESCRIPTION
A1I	Tension/compression asymmetry for initiation surface
A2I	Tension/compression asymmetry for initiation surface
BI	Radius for initiation surface
CI	Eccentricity of initiation surface with respect to material direction
KI	Coefficient in initiation energy
MI	Exponent in initiation energy
KL	Coefficient in volume fraction energy
ML	Exponent in volume fraction energy

Card 4	1	2	3	4	5	6	7	8
Variable	A1S	A2S	BS	CS	KS	MS		
Type	F	F	F	F	F	F		

VARIABLE**DESCRIPTION**

A1S	Tension/compression asymmetry for saturation surface
A2S	Tension/compression asymmetry for saturation surface
BS	Radius for saturation surface
CS	Eccentricity of saturation surface with respect to material direction
KS	Coefficient in saturation energy
MS	Exponent in saturation energy

Card 5	1	2	3	4	5	6	7	8
Variable	D0L	D0M						
Type	F	F						

VARIABLE**DESCRIPTION**

D0L	Initial driving force for volume fraction transformation
D0M	Initial driving force for martensite strain transformation

Card 6	1	2	3	4	5	6	7	8
Variable	XP	YP	ZP	A1	A2	A3	MACF	
Type	F	F	F	F	F	F	F	

VARIABLE**DESCRIPTION**

XP, YP, ZP	Coordinates of point <i>P</i> for AOPT = 1 and 4
------------	--

VARIABLE	DESCRIPTION
----------	-------------

A1, A2, A3 Components of vector **a** for AOPT = 2

MACF Material axes change flag for solid elements:
 EQ.-4: Switch material axes *b* and *c* before BETA rotation
 EQ.-3: Switch material axes *a* and *c* before BETA rotation
 EQ.-2: Switch material axes *a* and *b* before BETA rotation
 EQ.1: No change, default
 EQ.2: Switch material axes *a* and *b* after BETA rotation
 EQ.3: Switch material axes *a* and *c* after BETA rotation
 EQ.4: Switch material axes *b* and *c* after BETA rotation

Figure M2-2 indicates when LS-DYNA applies MACF during the process to obtain the final material axes. If BETA on *ELEMENT_SOLID_{OPTION} is defined, then that BETA is used for the rotation for all AOPT options. Otherwise, for AOPT = 3, the BETA input on Card 7 rotates the axes. For all other values of AOPT, the material axes will be switched as specified by MACF, but no BETA rotation will be performed.

Card 7	1	2	3	4	5	6	7	8
Variable	V1	V2	V3	D1	D2	D3	BETA	REF
Type	F	F	F	F	F	F	F	F

VARIABLE	DESCRIPTION
----------	-------------

V1, V2, V3 Components of vector **v** for AOPT = 3 and 4

D1, D2, D3 Components of vector **d** for AOPT = 2

BETA Material angle in degrees for AOPT = 3. This angle may be overridden on the element card; see *ELEMENT_SOLID_ORTHO.

REF Use reference geometry to initialize the stress tensor. The reference geometry is defined by the keyword: *INITIAL_FOAM_REFERENCE_GEOMETRY.

EQ.0.0: Off

EQ.1.0: On

Anisotropy Parameters Cards. This card and the following two cards are included if and only if STYPE = 1.

Card 8.1	1	2	3	4	5	6	7	8
Variable	N11	N22	N33	N44	N55	N66	N12	N23
Type	F	F	F	F	F	F	F	F

Card 8.2	1	2	3	4	5	6	7	8
Variable	N34	N45	N56	N13	N24	N35	N46	N14
Type	F	F	F	F	F	F	F	F

Card 8.3	1	2	3	4	5	6	7	8
Variable	N25	N36	N15	N26	N16			
Type	F	F	F	F	F	F	F	F

VARIABLE

DESCRIPTION

N_{ij}

Additional anisotropy parameters for initiation/saturation surface, relative to material axis given by AOPT. Used for STYPE = 1.

Remarks:

- Material Model.** The total strain ϵ is composed of elastic strain ϵ_e and martensite strain ϵ_m according to the additive split

$$\epsilon = \epsilon_e + \lambda \epsilon_m ,$$

where $0 \leq \lambda \leq 1$ is the volume fraction of martensite. Initially, the material is only composed of austenite, that is, $\lambda = 0$. The material is assumed to be isotropic elastic

$$\sigma = C(\lambda) : \epsilon_e ,$$

and the martensite strain is assumed to be trace-free

$$\text{tr}(\epsilon_m) = 0 .$$

Given the total strain ε and temperature T , this model finds λ and ε_m that minimize the mechanical energy

$$U = W + D ,$$

where W is the Helmholtz' free energy and D is the dissipated energy. The Helmholtz' free energy is here given by

$$W(\varepsilon, \lambda, \varepsilon_m, T) = \frac{1}{2} \sigma : \varepsilon + \lambda \omega(T) - c(\lambda) T \ln \left(\frac{T}{TC} \right) + \lambda G_I(\varepsilon_m) + G_S(\lambda \varepsilon_m) + G_\lambda(\lambda) ,$$

where

$$\omega(T) = LH \frac{T - TC}{TC} ,$$

$$c(\lambda) = \lambda \cdot CPM + (1 - \lambda) \cdot CPA .$$

The functions G_I and G_S denote initiation energy and saturation energy, respectively, and are defined as

$$G_i(x) = Ki \times \max(g_i(x), 0)^{Mi+1} , \quad i = I, S, \quad Ki, Mi > 0 ,$$

where the functions of g_I and g_S depends on the parameter STYPE. For negative values of g_i , there will be no contribution to the free energy and $g_i \leq 0$ thus defines the set of admissible values for λ and ε_m .

The function G_λ denotes volume fraction energy and is defined as

$$G_\lambda(\lambda) = \frac{KL \times \lambda^{ML+1}}{ML + 1} , \quad KL, ML \geq 0 .$$

Thus, the amount of stored energy in the system can increase with increasing volume fraction.

For STYPE = 0, we have

$$g_i(x) = -1 + \frac{1}{Bi} \left[\left(\frac{1}{2} x : x \right)^{\frac{3}{2}} - A1i \times \det(x) - Ci \times |n^T x n|^3 \right] , \quad i = I, S ,$$

where $Bi > 0$. The direction vector, n , is given by the main material direction defined with AOPT.

For STYPE = 1, we have

$$g_i(x) = -1 + \frac{1}{B_i^{A2i+1}} \sum_{n=1,2,3} [|\mu_n(N:x)| - A1i \times \mu_n(N:x)]^{A2i+1} , \quad i = I, S ,$$

for $-1 < A1i < 1$, $A2i > 0$, $Bi > 0$, and the principal values μ_n . The anisotropy tensor, N , is relative to the main material direction, n , defined with AOPT.

The driving forces for λ and ε_m are defined as

$$d_\lambda = -\frac{\partial W}{\partial \lambda} = -\frac{1}{2}C'(\lambda)\varepsilon_e:\varepsilon_e + \sigma:\varepsilon_m - \omega(T) + c'(\lambda)T_{t+\Delta t}\ln\left(\frac{T}{TC}\right) - G_i(\varepsilon_m) - \varepsilon_m:G'_s(\lambda\varepsilon_m) - G'_\lambda(\lambda_{t+\Delta t}),$$

$$d_{\varepsilon_m} = -\frac{\partial W}{\partial \varepsilon_m} = \lambda(\sigma - G'_i(\varepsilon_m) - G'_s(\lambda\varepsilon_m)),$$

and typically govern the evolution of λ , ε_m through evolution equations

$$\dot{\lambda} = f_\lambda(d_\lambda),$$

$$\dot{\varepsilon}_m = f_{\varepsilon_m}(d_{\varepsilon_m}).$$

In this model, λ and ε_m can, however, evolve freely, and the evolution is instead postulated to satisfy the kinetic relations:

$$\dot{\lambda} = 0, \text{ if } |d_\lambda| < \text{D0L},$$

$$d_\lambda \dot{\lambda} \geq 0,$$

$$|d_\lambda| \leq \text{D0L},$$

and

$$\dot{\varepsilon}_m = 0, \quad \text{if } \|d_{\varepsilon_m}\| < \lambda \frac{\text{D0M}}{\sqrt{1.5}},$$

$$d_{\varepsilon_m}:\dot{\varepsilon}_m \geq 0,$$

$$\|d_{\varepsilon_m}\| \leq \lambda \frac{\text{D0M}}{\sqrt{1.5}}, \quad \text{if } g_i(\varepsilon_m) \leq 0.$$

The norm is here defined as

$$\|d\| = \sqrt{d:d},$$

and the scaling factor $\sqrt{1.5}$ implies that D0M corresponds to the von Mises stress at which the martensite strains start to develop.

The above kinetic relations correspond to the rate of dissipation

$$\dot{D} = d_\lambda \dot{\lambda} + d_{\varepsilon_m}:\dot{\varepsilon}_m \geq 0,$$

and are incorporated in the model by minimizing the mechanical energy over one time-step

$$\Delta U = \int_t^{t+\Delta t} \dot{U} ds = \int_t^{t+\Delta t} (\dot{W} + \dot{D}) ds = \Delta W + \int_t^{t+\Delta t} \dot{D} ds$$

$$\leq \Delta W + \int_t^{t+\Delta t} \left(\text{D0L}|\dot{\lambda}| + \lambda \frac{\text{D0M}}{\sqrt{1.5}} \|\dot{\varepsilon}_m\| \right) ds$$

$$\approx \Delta W + \text{D0L}|\lambda_{t+\Delta t} - \lambda_t| + \lambda_t \frac{\text{D0M}}{\sqrt{1.5}} \|\varepsilon_m^{t+\Delta t} - \varepsilon_m^t\|,$$

with respect to $\lambda_{t+\Delta t}$ and $\varepsilon_m^{t+\Delta t}$. The evolution of λ and ε_m is thus constrained by the time step.

Minimizing the mechanical energy over one time-step with respect to $\lambda_{t+\Delta t}$ and $\varepsilon_m^{t+\Delta t}$ gives the optimality constraints

$$\begin{aligned}\frac{\partial U_{t+\Delta t}}{\partial \lambda_{t+\Delta t}} &= -d_\lambda^{t+\Delta t} + \text{D0L} \times \text{sign}(\lambda_{t+\Delta t} - \lambda_t) = 0, \\ \frac{\partial U_{t+\Delta t}}{\partial \varepsilon_m^{t+\Delta t}} &= -d_{\varepsilon_m}^{t+\Delta t} + \lambda_t \frac{\text{D0M} (\varepsilon_m^{t+\Delta t} - \varepsilon_m^t)}{\sqrt{1.5} \|\varepsilon_m^{t+\Delta t} - \varepsilon_m^t\|} = 0,\end{aligned}$$

and incorporating the trace-free condition on ε_m gives

$$\begin{aligned}\frac{\partial U_{t+\Delta t}}{\partial \lambda_{t+\Delta t}} &= 0, \\ \frac{\partial U_{t+\Delta t}}{\partial (\varepsilon_m^{t+\Delta t})_i} - \frac{\partial U_{t+\Delta t}}{\partial (\varepsilon_m^{t+\Delta t})_3} &= 0, \quad i = 1,2, \\ \frac{\partial U_{t+\Delta t}}{\partial (\varepsilon_m^{t+\Delta t})_i} &= 0, \quad i = 4,5,6.\end{aligned}$$

2. **Transition Temperatures.** The initial (zero stress) austenite and martensite start and finish temperatures, $\text{TMF} \leq \text{TMS} \leq \text{TAS} \leq \text{TAF}$, can be given instead of the parameters TC, KL, and D0L. The temperatures are defined as

$$\begin{aligned}\text{TMS} &= \text{TC} \left(1 - \frac{\text{D0L}}{\text{LH}} \right) \\ \text{TMF} &= \text{TC} \left(1 - \frac{\text{D0L} + \text{KL}}{\text{LH}} \right) \\ \text{TAS} &= \text{TC} \left(1 + \frac{\text{D0L} - \text{KL}}{\text{LH}} \right) \\ \text{TAF} &= \text{TC} \left(1 + \frac{\text{D0L}}{\text{LH}} \right)\end{aligned}$$

which gives

$$\begin{aligned}\text{TC} &= \frac{1}{2} (\text{TMS} + \text{TAF}) \\ \frac{\text{KL}}{\text{LH}} &= 1 - \frac{\text{TMF} + \text{TAS}}{\text{TMS} + \text{TAF}} \\ \frac{\text{D0L}}{\text{LH}} &= \frac{\text{TAF} - \text{TMS}}{\text{TAF} + \text{TMS}}\end{aligned}$$

Thus, if $0 < \text{TMF} \leq \text{TMS} \leq \text{TAS} \leq \text{TAF}$ are given as keyword input, then TC, KL, and D0L are calculated as above, and their keyword values are ignored.

3. **Heat Generation.** The internal energy is

$$\epsilon = W - \eta T ,$$

and the entropy is defined as

$$\eta = -\frac{\partial W}{\partial T} = -\lambda \frac{\text{LH}}{\text{TC}} + c(\lambda) \left(1 + \ln \left(\frac{T}{\text{TC}} \right) \right) .$$

From the differential of W , we have

$$\dot{W} = \sigma : \dot{\varepsilon} - D - \eta \dot{T} ,$$

and thus

$$\dot{\varepsilon} = \sigma : \dot{\varepsilon} - D - \eta \dot{T} - (\dot{\eta}T + \eta \dot{T}) = \sigma : \dot{\varepsilon} - D - \dot{\eta}T .$$

Combining this with the energy balance

$$\dot{\varepsilon} = \sigma : \dot{\varepsilon} + \nabla \cdot (k \nabla T) ,$$

we get

$$c(\lambda) \dot{T} = \nabla \cdot (k \nabla T) + Q ,$$

with the volumetric heat generation rate

$$Q = T \frac{LH}{TC} \dot{\lambda} - T c'(\lambda) \dot{\lambda} \left(1 + \ln \left(\frac{T}{TC} \right) \right) + D .$$

4. **History Variables.** The following history variables are available:

History Variable #	Description
1-6	Strain in local coordinate system (ε)
7-12	Martensite strain in local system (ε_m)
13	Martensite volume fraction (λ)
14	Volumetric heat generation (Q)
15-20	Stress in local system (σ)

In a thermal analysis, *MAT_291 can be coupled with *MAT_THERMAL_ISO-TROPIC_TD_LC with load curves HCLC/TCLC depending on history variable 13, and load curve TGRLC depending on history variable 14. Note that *MAT_291 uses volumetric quantities for CPA, CPM, and LH while the thermal materials use specific quantities, meaning the volumetric quantity divided by density.

***MAT_ELASTIC_PERI**

This is Material Type 292. This material is valid for modeling brittle elastic materials with peridynamics solids. Material failure is captured through a bond-based peridynamics model. See Ren et al 2017 for details about this model.

Card 1	1	2	3	4	5	6	7	8
Variable	MID	RO	E	GT	GS			
Type	I/A	I	F	F	F			
Default	none	none	none	10 ²⁰	10 ²⁰			

VARIABLE**DESCRIPTION**

MID	Material identification. A unique number or label must be specified (see *PART).
RO	Material density
E	Young's modulus
GT	Fracture energy release rate
GS	Fracture energy release rate for compression

References:

B Ren, CT Wu, E Askari (2017) A 3D discontinuous Galerkin finite element method with the bond-based peridynamics model for dynamic brittle failure analysis, International Journal of Impact Engineering 99, 14-25.

***MAT_ELASTIC_PERI_LAMINATE**

This is Material Type 292A. This material is for modeling unidirectional fiber reinforced polymer laminates with peridynamics. Each lamina is modeled as a transversely isotropic material while the matrix is assumed to be isotropic. See Ren et al 2018 for details about this model.

Card 1	1	2	3	4	5	6	7	8
Variable	MID	RO	E1	E2	PR12	G12		
Type	I/A	F	F	F	F	F		
Default	none	none	none	none	none	none		

Card 2	1	2	3	4	5	6	7	8
Variable	FOPT	FC1	FC2	FCC1	FCC2	FCD	FCDC	
Type	I	F	F	F	F	F	F	
Default	none	none	none	none	none	none	none	

Card 3	1	2	3	4	5	6	7	8
Variable	V1	V2	V3					
Type	F	F	F					
Default	none	none	none					

VARIABLE**DESCRIPTION**

MID Material identification. A unique number or label must be specified (see *PART).

RO Material density

VARIABLE	DESCRIPTION
E1	Young's modulus-longitudinal direction for one lamina (1-direction)
E2	Young's modulus-transverse direction for one lamina (2-direction)
PR12	Poisson's ratio in the lamina plane
G12	Shear modulus in the 12-direction
FOPT	Failure criterion type for FC1, FC2, FCC1, FCC2, FCD, and FCDC: EQ.1: Energy release rate EQ.2: Failure stretch ratio for tension (recommended)
FC1	Tension failure criterion for longitudinal direction, 1-direction
FC2	Tension failure criterion for transverse direction, 2-direction
FCC1	Compression failure criterion for longitudinal direction, 1-direction
FCC2	Compression failure criterion for transverse direction, 2-direction
FCD	Tension delamination failure criterion
FCDC	Compression delamination failure criterion
V1, V2, V3	Components of the reference fiber direction in the global coordinate system

References:

B Ren, CT Wu, P Seleson, D Zeng, D Lyu (2018) A peridynamic failure analysis of fiber-reinforced composite laminates using finite element discontinuous Galerkin approximations, International Journal of Fracture 214 (1), 49-68.

***MAT_COMPFR**

This is Material Type 293. This material models the behavior of pre-impregnated (pre-preg) composite fibers during the high temperature preforming process. In addition to providing stress and strain, it also provides warp and weft yarn directions and stretch ratios after the forming process. The major applications of the model are for materials used in light weight automobile parts.

Card 1	1	2	3	4	5	6	7	8
Variable	MID	RO	ET	EC	PR	G121	G122	G123
Type	A8	F	F	F	F	F	F	F

Card 2	1	2	3	4	5	6	7	8
Variable	G124	G125	G126	GAMMAL	VF	EF3	VF23	EM
Type	F	F	F	F	F	F	F	F

Card 3	1	2	3	4	5	6	7	8
Variable	VM	EPSILON	THETA	BULK	G			
Type	F	F	F	F	F			

VARIABLE**DESCRIPTION**

MID	Material identification. A unique number or label not exceeding 8 characters must be specified.
RO	Continuum equivalent mass density.
ET	Tensile modulus along the fiber yarns, corresponding to the slope of the curve in Figure M293-2 in the Stable Modulus region from a uniaxial tension test. See Remark 6 .
EC	Compression modulus along the fiber yarns, reversely calculated using bending tests when all the other material properties are determined. See Remark 6 .

VARIABLE	DESCRIPTION
PR	Poisson's ratio. See Remark 6 .
G12 _i	Coefficients for the bias-extension angle change-engineering stress curve in Figure M293-3 . G121 to G126 corresponds to the 6 th order to 1 st order factors of the loading curve. See Remark 6 .
GAMMAL	Shear locking angle, in degrees. See Remark 6 .
VF	Fiber volume fraction in the prepreg composite.
EF3	Transverse compression modulus of the dry fiber.
VF23	Transverse Poisson's ratio of the dry fiber
EM	Young's modulus of the cured resin.
VM	Poisson's ratio of the cured resin
EPSILON	Stretch ratio at the end of undulation stage during the uniaxial tension test. Example shown in Figure M293-2 . See Remark 6 .
THETA	Initial angle offset between the fiber direction and the element direction. To reduce simulation error, when building the model, the elements should be aligned to the same direction as much as possible.
BULK	Bulk modulus of the prepreg material
G	Shear modulus of the prepreg material

Remarks:

- Fiber and Resin Properties.** The dry fiber properties, EF3 and VF23, and the cure resin properties, EM and VM, are used to calculate the through thickness elastic modulus of the prepreg using the rule of mixture. These properties will not affect the in-plane deformation of the prepreg during the preforming simulation.
- Shear Locking.** In most of the preforming cases, the angle between the fiber yarns will not reach the shear locking state. This model is not designed for, and, therefore, not recommended for simulating shear locking.
- History Variables.** hsv1 represents the angle between warp/weft yarns, and hsv2,3 are the stretch ratio of fibers in 1,2 directions respectively.

4. **BULK and G.** BULK and G are used by the contact algorithm. Changing these parameters will not affect the final simulation result significantly (but it may affect the time step).
5. **Model Description.** Woven composite prepregs are characterized using a non-orthogonal coordinate system having two principal directions: one aligned with the longitudinal warp yarns and the other with the transverse weft yarns. Prior to deformation the warp and weft yarns are orthogonal. The directions and the fiber stretch ratios are determined from the deformation gradient. In [Figure M293-1](#), the angles α and β refer to the relative of the rotation of the warp yarn coordinate to the local corotational x coordinate and the angle between the warp and weft yarns, respectively [2,3,4].

The stress from material deformation is divided into two parts: (1) stress caused by the fiber stretch, σ^f , as shown in [Figure M293-1](#) (a); (2) stress caused by the fiber rotation, σ^m , as shown in [Figure M293-1](#) (b). The total stress tensor, σ , in the local corotational $x - y$ coordinate system is the sum where the components are given below [3]:

$$\sigma_{xx}^f = \sigma_1^f \cos^2 \alpha + \sigma_2^f \cos^2(\alpha + \beta) \quad (1)$$

$$\sigma_{xy}^f = \sigma_{yx}^f = \frac{1}{2} \sigma_1^f \sin 2\alpha + \frac{1}{2} \sigma_2^f \sin 2(\alpha + \beta) \quad (2)$$

$$\sigma_{yy}^f = \sigma_1^f \sin^2 \alpha + \sigma_2^f \sin^2(\alpha + \beta) \quad (3)$$

$$\sigma_{xx}^m = \frac{\sigma_1^m + \sigma_2^m}{2} + \frac{\sigma_1^m - \sigma_2^m}{2} \cos(2\alpha + \beta) \quad (4)$$

$$\sigma_{xy}^m = \sigma_{yx}^m = \frac{\sigma_1^m - \sigma_2^m}{2} \sin(2\alpha + \beta) \quad (5)$$

$$\sigma_{yy}^m = \frac{\sigma_1^m + \sigma_2^m}{2} - \frac{\sigma_1^m - \sigma_2^m}{2} \cos(2\alpha + \beta) \quad (6)$$

$$\sigma_{xx} = \sigma_{xx}^f + \sigma_{xx}^m \quad (7)$$

$$\sigma_{xy} = \sigma_{yx} = \sigma_{xy}^f + \sigma_{xy}^m \quad (8)$$

$$\sigma_{yy} = \sigma_{yy}^f + \sigma_{yy}^m \quad (9)$$

6. **Material Property Characterization.** The non-orthogonal stress components caused by yarn stretch and rotation at various deformation states will be characterized via a set of experiments, which are uniaxial tension, bias-extension and cantilever beam bending tests. All the tests need to be performed at the pre-forming temperature. See references [1] and [3] for more details.

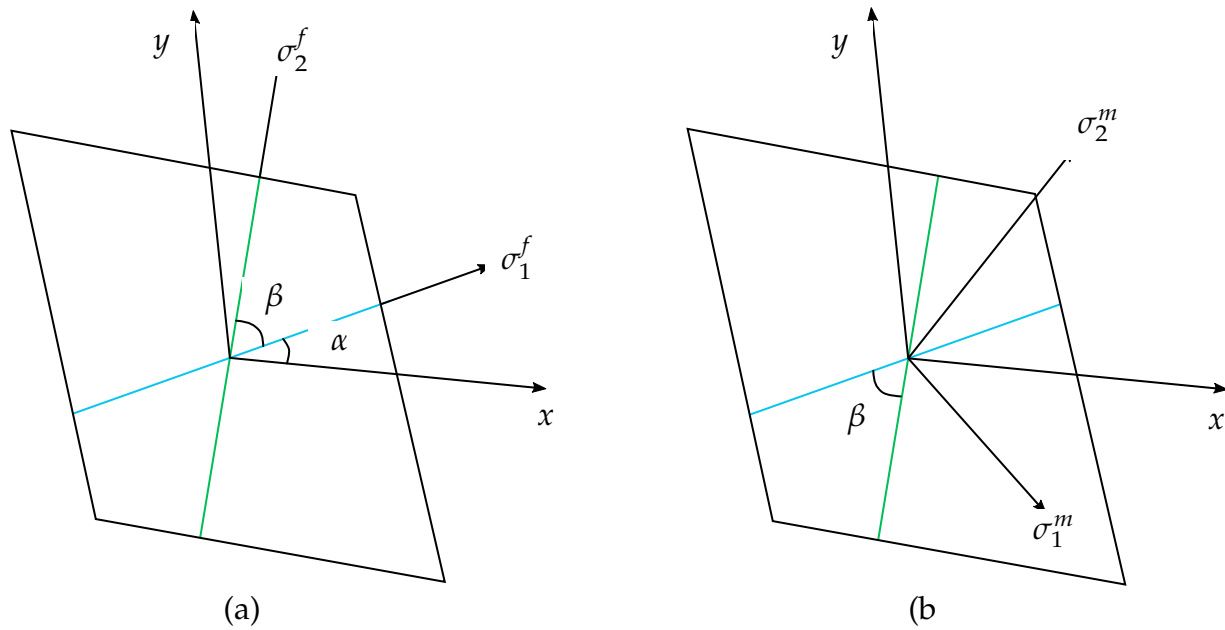

Figure M293-1. Stress components caused by (a) stretch in fiber directions and (b) rotation of the fibers [3].

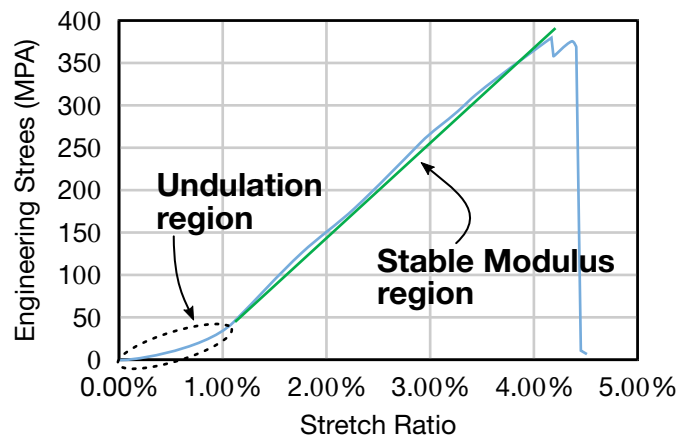

Figure M293-2. An example of the engineering stress as a function of stretch ratio from the uniaxial tension test [3].

The uniaxial tension test is used to obtain the fiber direction undulation strains and the stable tensile moduli, together with the in-plane Poisson’s ratio (PR). A typical test result is shown in [Figure M293-2](#). From the stretch ratio-engineering stress curve, the tensile modulus, ET, and the stretch ratio at the end of undulation, EPSILON, can be captured.

The bias-extension test is used to characterize the shear behavior of the composite needed for fields G12i. The test procedure comes from the benchmark test literature [1]. An example of the bias-extension test angle change-engineering stress curve is shown in [Figure M293-3](#).

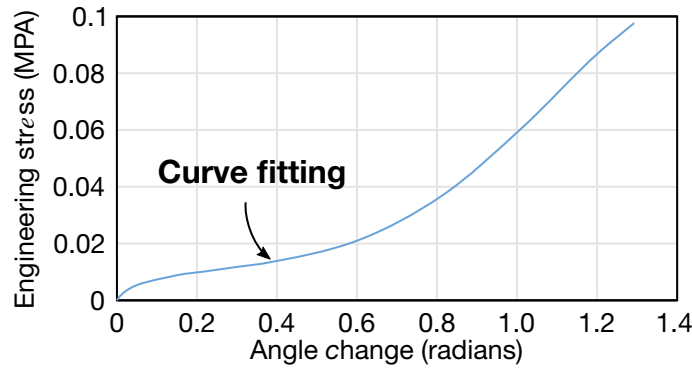

Figure M293-3. An example of the angle change-engineering stress curve from the bias-extension test. The curve fit for this example is $y = -0.29x^6 + 1.09x^5 - 1.68x^4 + 1.37x^3 - 0.56x^2 + 0.12x$. For this example curve the inputs into LS-DYNA are $G121 = -0.29$, $G122 = 1.09$, $G123 = -1.68$, $G124 = 1.37$, $G125 = -0.56$, and $G126 = -0.12$ [3].

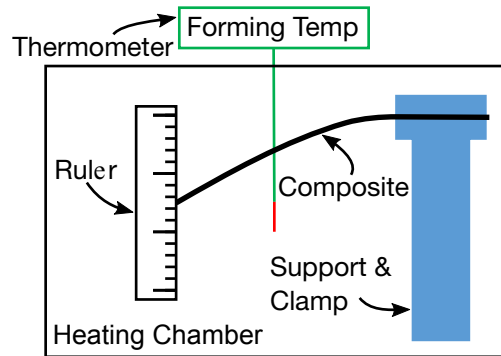

Figure M293-4. Bending test setup [3]

The angle change is calculated by using the equation [1]:

$$\gamma = \frac{\pi}{2} - 2 \cos^{-1} \frac{D + d}{\sqrt{2}D}$$

where d is the cross-head displacement and D is the difference between the original height and the original width of the sample. This equation holds only before the shear locking angle, specified in field GAMMAL, which is measured directly at the end of the test, so the curve should end when the fiber yarn angle reaches the shear locking state.

The bending test should be performed to characterize the compression modulus along the yarn directions, as specified in the EC field. The test setup is shown in [Figure M293-4](#). The composite specimen is held in a clamp and deforms under its own gravity. During the test, the composite is heated to the preforming temperature and the tip displacement is recorded. Due to the nonlinearity of the tensile modulus, the compression modulus is reversely calculated using a simulation: it is adjusted until the simulation leads to similar tip displacement to the

real experiment case. The starting point for the compression modulus iteration can be set as about 100X of the shear modulus when the warp and weft yarns are perpendicular to each other.

7. **Element Type.** The material model is available for shell elements with OSU=1 and INN=2 in the CONTROL_ACCURACY card. It is recommended to use a double precision version of LS-DYNA.

References:

- [1] J. Cao, R. Akkerman, P. Boisse, J. Chen, H.S. Cheng, E.F. de Graaf, J.L. Gorczyca, P. Harrison, G. Hivet, J. Launay, W. Lee, L. Liu, S.V. Lomov, A. Long, E. de Luycker, F. Morestin, J. Padvoiskis, X.Q. Peng, J. Sherwood, Tz. Stoilova, X.M. Tao, I. Verpoest, A. Willems, J. Wiggers, T.X. Yu, B. Zhu, Characterization of mechanical behavior of woven fabrics: Experimental methods and benchmark results, *Composites Part A: Applied Science and Manufacturing*, Volume 39, Issue 6, 2008, Pages 1037-1053, ISSN 1359-835X.
- [2] Pu Xue, Xiongqi Peng, Jian Cao, A non-orthogonal constitutive model for characterizing woven composites, *Composites Part A: Applied Science and Manufacturing*, Volume 34, Issue 2, 2003, Pages 183-193, ISSN 1359-835X.
- [3] Weizhao Zhang, Huaqing Ren, Biao Liang, Danielle Zeng, Xuming Su, Jeffrey Dahl, Mansour Mirdamadi, Qiangsheng Zhao, Jian Cao, A non-orthogonal material model of woven composites in the preforming process, *CIRP Annals - Manufacturing Technology*, Volume 66, Issue 1, 2017, Pages 257-260, ISSN 0007-8506.
- [4] X.Q. Peng, J. Cao, A continuum mechanics-based non-orthogonal constitutive model for woven composite fabrics, *Composites Part A: Applied Science and Manufacturing*, Volume 36, Issue 6, 2005, Pages 859-874, ISSN 1359-835X.

***MAT_ANISOTROPIC_HYPERELASTIC**

This is Material Type 295 which includes a collection of *(nearly-in)compressible, (an)isotropic, hyperelastic* material models primarily aimed at describing the mechanical behavior of biological soft tissues. Some of the material models may also be used to analyze a wider class of materials including fiber-reinforced elastomers and stretchable fabrics.

The constitutive laws are implemented in a modular fashion. Each module may be invoked at most once, however, the order of modules is interchangeable. Each module may comprise of different models. Consequently, one may easily change models in a module and include additional modules to account for more complex material behavior within the same keyword. Extending an existing module with a new model or even including a new module is straightforward and does not require a new material keyword.

Card Summary:

Card 1. This card is required.

MID	RHO	AOPT					
-----	-----	------	--	--	--	--	--

Card 2. ISOtropic module. This card and all related cards below are required.

TITLE	ITYPE	BETA	NU				
-------	-------	------	----	--	--	--	--

Card 2.1a. Include this card if ITYPE = ± 1 .

MU1	MU2	MU3	MU4	MU5	MU6	MU7	MU8
-----	-----	-----	-----	-----	-----	-----	-----

Card 2.2a. Include this card if ITYPE = ± 1 .

ALPHA1	ALPHA2	ALPHA3	ALPHA4	ALPHA5	ALPHA6	ALPHA7	ALPHA8
--------	--------	--------	--------	--------	--------	--------	--------

Card 2.1b. Include this card if ITYPE = -2.

C1	C2	C3					
----	----	----	--	--	--	--	--

Card 2.1c. Include this card if ITYPE = ± 3 .

K1	K2						
----	----	--	--	--	--	--	--

Card 3. ANISOtropic module. This card and all related cards below are optional.

TITLE	ATYPE	INTYPE	NF				
-------	-------	--------	----	--	--	--	--

Card 3.1. Include this card if $ATYPE = \pm 1$. Include a pair of this card and one of the following two cards for each fiber family $i = 1, \dots, NF$, that is, $2 \times NF$ cards in total.

THETA	A	B					
-------	---	---	--	--	--	--	--

Card 3.2a. Include this card if $FTYPE = 1$.

FTYPE	FCID	K1	K2				
-------	------	----	----	--	--	--	--

Card 3.2b. Include this card if $FTYPE = 2$.

FTYPE	FCID	E	RONORM	HONORM			
-------	------	---	--------	--------	--	--	--

Card 3.3. Include this card if $INTYPE = 1$.

K1	K2						
----	----	--	--	--	--	--	--

Card 4. ACTIVE module. This and all related cards below are optional and may only be used in combination with the ANISOTropic module.

TITLE	ACTYPE	ACDIR	ACID	ACTHR	SF	SS	SN
-------	--------	-------	------	-------	----	----	----

Card 4.1a. Include this card if $ACTYPE = 1$.

T0	CA2ION	CA2IONM	N	TAUMAX	ST	B	L0
----	--------	---------	---	--------	----	---	----

Card 4.2a. Include this card if $ACTYPE = 1$.

L	DTMAX	MR	TR				
---	-------	----	----	--	--	--	--

Card 4.1b. Include this card if $ACTYPE = 2$.

T0	CA2ION	CA2IONM	N	TAUMAX	ST	B	L0
----	--------	---------	---	--------	----	---	----

Card 4.2b. Include this card if $ACTYPE = 2$.

L	ETA						
---	-----	--	--	--	--	--	--

Card 4.1c. Include this card if $ACTYPE = 3$.

T0	CA2ION	CA2ION50	N	TAUMAX	ST	L	ETA
----	--------	----------	---	--------	----	---	-----

Card 4.1d. Include this card if $ACTYPE = 4$.

T0	CA2ION50	CA2IONM	N	TAUMAX	ST	CA2ION0	TCA
----	----------	---------	---	--------	----	---------	-----

Card 4.2d. Include this card if ACTYPE = 4.

L	ETA						
---	-----	--	--	--	--	--	--

Card 4.1e. Include this card if ACTYPE = 5.

FSEID	FLID	FVID	ALPHAID				
-------	------	------	---------	--	--	--	--

Card 5. This card is optional and must be used in combination with the ANISOTropic module only.

XP	YP	ZP	A1	A2	A3	MACF	
----	----	----	----	----	----	------	--

Card 6. This card is optional and must be used in combination with the ANISOTropic module only.

V1	V2	V3	D1	D2	D3	BETA	REF
----	----	----	----	----	----	------	-----

Data Card Definitions:

Card 1	1	2	3	4	5	6	7	8
Variable	MID	RHO	AOPT					
Type	A	F	F					

VARIABLE

DESCRIPTION

MID	Material identification. A unique number or label must be specified (see *PART).
RHO	Mass density
AOPT	Material axes option (see *MAT_002 for a more complete description):

EQ.0.0: Locally orthotropic with material axes determined by element nodes. The **a**-direction is from node 1 to node 2 of the element. The **b**-direction is orthogonal to the **a**-direction and is in the plane formed by nodes 1, 2, and 4. For shells only, the material axes are then rotated about the normal vector to the surface of the shell by the angle BETA.

VARIABLE**DESCRIPTION**

- EQ.1.0: Locally orthotropic with material axes determined by a point, P , in space and the global location of the element center; this is the \mathbf{a} -direction. This option is for solid elements only.
- EQ.2.0: Globally orthotropic with material axes determined by vectors \mathbf{a} and \mathbf{d} input below, as with *DEFINE_COORDINATE_VECTOR
- EQ.3.0: Locally orthotropic material axes determined by a vector \mathbf{v} and the normal vector to the plane of the element. The plane of a solid element is the midsurface between the inner surface and outer surface defined by the first four nodes and the last four nodes of the connectivity of the element, respectively. Thus, for solid elements, AOPT = 3 is only available for hexahedrons. \mathbf{a} is determined by taking the cross product of \mathbf{v} with the normal vector, \mathbf{b} is determined by taking the cross product of the normal vector with \mathbf{a} , and \mathbf{c} is the normal vector. Then \mathbf{a} and \mathbf{b} are rotated about \mathbf{c} by an angle BETA. BETA may be set in the keyword input for the element or in the input for this keyword. Note that for solids, the material axes may be switched depending on the choice of MACF. The switch may occur before or after applying BETA depending on MACF.
- EQ.4.0: Locally orthotropic in a cylindrical coordinate system with the material axes determined by a vector \mathbf{v} , and an originating point, P , which define the centerline axis. This option is for solid elements only.
- LT.0.0: |AOPT| is a coordinate system ID (see *DEFINE_COORDINATE_OPTION).

Isotropic Module Card.

Card 2	1	2	3	4	5	6	7	8
Variable	TITLE	ITYPE	BETA	NU				
Type	A10	I	F	F				
Default	none	none	0.0	none				

VARIABLE	DESCRIPTION
TITLE	Module title which must be set to ISO
ITYPE	Type of isotropic model (see Remarks 1 and 2): EQ.±1: Compressible/nearly-incompressible Ogden [12] (see Remark 4) EQ.-2: Yeoh [13] EQ.±3: Compressible/nearly-incompressible Holzapfel-Ogden [1] , [7]
BETA	Volumetric response function coefficient
NU	Poisson’s ratio (see Remark 3)

Ogden Model Card 1. This card is only defined if $ITYPE = \pm 1$.

Card 2.1a	1	2	3	4	5	6	7	8
Variable	MU1	MU2	MU3	MU4	MU5	MU6	MU7	MU8
Type	F	F	F	F	F	F	F	F

Ogden Model Card 2. This card is only defined if $ITYPE = \pm 1$.

Card 2.2a	1	2	3	4	5	6	7	8
Variable	ALPHA1	ALPHA2	ALPHA3	ALPHA4	ALPHA5	ALPHA6	ALPHA7	ALPHA8
Type	F	F	F	F	F	F	F	F

VARIABLE	DESCRIPTION
MU_i	Ogden moduli, with $i = 1, \dots, 8$
$ALPHA_i$	Ogden constants, with $i = 1, \dots, 8$

Yeoh Model Card. This card is only defined if ITYPE = -2.

Card 2.1b	1	2	3	4	5	6	7	8
Variable	C1	C2	C3					
Type	F	F	F					

VARIABLE

DESCRIPTION

C_i Yeoh moduli, with $i = 1,2,3$

Holzappel-Ogden Model Card. This card is only defined if ITYPE = ±3.

Card 2.1c	1	2	3	4	5	6	7	8
Variable	K1	K2						
Type	F	F						

VARIABLE

DESCRIPTION

K1 Holzappel-Ogden modulus
 K2 Holzappel-Ogden constant

Anisotropic Module Card.

Card 3	1	2	3	4	5	6	7	8
Variable	TITLE	ATYPE	INTYPE	NF				
Type	A10	I	I	I				
Default	none	none	none	none				

VARIABLE

DESCRIPTION

TITLE Module title which must be set to ANISO

VARIABLE	DESCRIPTION
ATYPE	Type of anisotropic model: EQ.±1: General structure tensor-based; see Holzapfel et al. [8] (see Remark 5)
INTYPE	Type of interaction/coupling (see Remarks 6 and 7): EQ.0: None EQ.1: Holzapfel-Ogden [1], [5]
NF	Number of fiber families (see Remarks 5 and 6)

General Structure Tensor-Based Model Card A. This card is only defined if ATYPE = ±1. Include a pair of this card and one of the 2 cards following this card for each fiber family $i = 1, \dots, NF$, that is, $2 \times NF$ cards in total.

Card 3.1	1	2	3	4	5	6	7	8
Variable	THETA	A	B					
Type	F	F	F					

VARIABLE	DESCRIPTION
THETA	Mean fiber family orientation angle with respect to the a material axis in the ab material plane in degrees
A	First structure tensor parameter
B	Second structure tensor parameter

Holzapfel-Gasser-Ogden Model Card. This card is only defined if FTYPE = 1.

Card 3.2a	1	2	3	4	5	6	7	8
Variable	FTYPE	FCID	K1	K2				
Type	I	I	F	F				

Freed-Doehring Model Card. This card is only defined if FTYPE = 2.

Card 3.2b	1	2	3	4	5	6	7	8
Variable	FTYPE	FCID	E	R0NORM	H0NORM			
Type	I	I	F	F	F			

VARIABLE

DESCRIPTION

FTYPE	Type of fiber model: EQ.1: Holzapfel-Gasser-Ogden [6] EQ.2: Freed-Doehring [2]
FCID	Curve ID defining the fiber stress as a function of fiber stretch, default if nonzero.
K1	Holzapfel-Gasser-Ogden modulus
K2	Holzapfel-Gasser-Ogden constant
E	Fiber modulus
R0NORM	Initial crimp/coil amplitude normalized with respect to the initial fiber radius (R_0/r_0)
H0NORM	Initial crimp/coil wavelength normalized with respect to the initial fiber radius (H_0/r_0)

Holzapfel-Ogden Coupling Model Card(s). These cards are only defined if IN-TYPE = 1.

Card 3.3	1	2	3	4	5	6	7	8
Variable	K1	K2						
Type	F	F						

VARIABLE

DESCRIPTION

K1	Coupling modulus between the fiber and sheet directions
K2	Coupling constant between the fiber and sheet directions

Active Module Card.

Card 4	1	2	3	4	5	6	7	8
Variable	TITLE	ACTYPE	ACDIR	ACID	ACTHR	SF	SS	SN
Type	A10	I	I	I	F	F	F	F
Default	none	none	0	0	0.0	none	none	none

VARIABLE**DESCRIPTION**

TITLE	Module title which must be set to ACTIVE
ACTYPE	Type of active model: EQ.1: Guccione-Waldman-McCulloch [4] EQ.2: Guccione-Waldman-McCulloch [4] and Hunter-Nash-Sands [9] EQ.3: Hunter-Nash-Sands [9] EQ.4: Hunter-Nash-Sands [9] and Hunter-McCulloch-ter Keurs [10] EQ.5: Martins-Pato-Pires [14]
ACDIR	Direction of active tension: EQ.0: Active tension develops along the mean fiber orientation of all fiber families. GT.0: Active tension develops along the mean orientation of the ACDIR th fiber family.
ACID	Activation curve ID (takes priority over T0 for ACTYPE = 1, 2, 3, or 4 when defined, see Remark 8)
ACTHR	(De/re)activation threshold (see Remark 8)
SF	Active stress scaling factor in the fiber direction (see Remark 9)
SS	Active stress scaling factor in the transverse sheet direction (see Remark 9)

VARIABLE	DESCRIPTION
SN	Active stress scaling factor in the transverse normal direction (see Remark 9)

Guccione-Waldman-McCulloch Model Card 1. This card is only defined if AC-TYPE = 1.

Card 4.1a	1	2	3	4	5	6	7	8
Variable	T0	CAION	CAIONM	N	TAUMAX	ST	B	L0
Type	F	F	F	F	F	F	F	F

Guccione-Waldman-McCulloch Model Card 2. This card is only defined if AC-TYPE = 1.

Card 4.2a	1	2	3	4	5	6	7	8
Variable	L	DTMAX	MR	TR				
Type	F	F	F	F				

VARIABLE	DESCRIPTION
T0	Starting time of active stress development
CA2ION	Intercellular calcium ion concentration
CA2IONM	Maximum intercellular calcium ion concentration
N	Hill coefficient
TAUMAX	Peak isometric tension under maximum activation
ST	Active fiber stress scaling factor in the transverse directions (see Remark 9)
B	Shape coefficient
L0	Sarcomere length with no active tension
L	Reference (stress-free) sarcomere length

VARIABLE	DESCRIPTION
DTMAX	Time to peak tension
MR	Slope of linear relaxation versus sarcomere length relation
TR	Time intercept of linear relaxation as a function of sarcomere length relation

Guccione-Waldman-McCulloch and Hunter-Nash-Sands Model Card 1. This card is only defined if ACTYPE = 2.

Card 4.1b	1	2	3	4	5	6	7	8
Variable	T0	CA2ION	CA2IONM	N	TAUMAX	ST	B	L0
Type	F	F	F	F	F	F	F	F

Guccione-Waldman-McCulloch and Hunter-Nash-Sands Model Card 2. This card is only defined if ACTYPE = 2.

Card 4.2b	1	2	3	4	5	6	7	8
Variable	L	ETA						
Type	F	F						

VARIABLE	DESCRIPTION
T0	Starting time of active stress development
CA2ION	Intercellular calcium ion concentration
CA2IONM	Maximum intercellular calcium ion concentration
N	Hill coefficient
TAUMAX	Peak isometric tension under maximum activation
ST	Active fiber stress scaling factor in the transverse directions (see Remark 9)
B	Shape coefficient

VARIABLE	DESCRIPTION
L0	Sarcomere length with no active tension
L	Reference (stress-free) sarcomere length
ETA	Scaling parameter

Hunter-Nash-Sands Model Card 1. This card is only defined if ACTYPE = 3.

Card 4.1c	1	2	3	4	5	6	7	8
Variable	T0	CA2ION	CA2ION50	N	TAUMAX	ST	L	ETA
Type	F	F	F	F	F	F	F	F

VARIABLE	DESCRIPTION
T0	Starting time of active stress development
CA2ION	Intercellular calcium ion concentration
CA2ION50	Intercellular calcium ion concentration at half of peak isometric tension
N	Hill coefficient
TAUMAX	Peak isometric tension under maximum activation
ST	Active fiber stress scaling factor in the transverse directions (see Remark 9)
L	Reference (stress-free) sarcomere length
ETA	Scaling parameter

Hunter-Nash-Sands and Hunter-McCullogh-ter Keurs Model Card A. This card is only defined if ACTYPE = 4.

Card 4.1d	1	2	3	4	5	6	7	8
Variable	T0	CA2ION50	CA2IONM	N	TAUMAX	ST	CA2ION0	TCA
Type	F	F	F	F	F	F	F	F

Hunter-Nash-Sands and Hunter-McCullogh-ter Keurs Model Card B. This card is only defined if ACTYPE = 4.

Card 4.2d	1	2	3	4	5	6	7	8
Variable	L	ETA						
Type	F	F						

VARIABLE**DESCRIPTION**

T0	Starting time of active stress development
CA2ION50	Intercellular calcium ion concentration at half of peak isometric tension
CA2IONM	Maximum intercellular calcium ion concentration
N	Hill coefficient
TAUMAX	Peak isometric tension under maximum activation
ST	Active fiber stress scaling factor in the transverse directions (see Remark 9)
CA2ION0	Intercellular calcium ion concentration at rest
TCA	Shape coefficient
L	Reference (stress-free) sarcomere length
ETA	Scaling parameter

Martins-Pato-Pires Model Card A. This card is only defined if ACTYPE = 5.

Card 4.1e	1	2	3	4	5	6	7	8
Variable	FSEID	FLID	FVID	ALPHAID				
Type	I	I	I	I				

VARIABLE**DESCRIPTION**

FSEID	Serial stress function ID (see Remark 10)
FLID	Normalized force-contractile stretch curve ID
FVID	Normalized force-contractile stretch rate curve ID
ALPHAID	Activation curve ID

Local Coordinate System Card A. These cards are only defined in combination with the ANISOTropic module.

Card 5	1	2	3	4	5	6	7	8
Variable	XP	YP	ZP	A1	A2	A3	MACF	
Type	F	F	F	F	F	F	I	

Local Coordinate System Card B.

Card 6	1	2	3	4	5	6	7	8
Variable	V1	V2	V3	D1	D2	D3	BETA	REF
Type	F	F	F	F	F	F	F	F

VARIABLE**DESCRIPTION**

XP, YP, ZP	Coordinates of point <i>P</i> for AOPT = 1 and 4
A1, A2, A3	Components of vector a for AOPT = 2
MACF	Material axes change flag for solid elements (see *MAT_002 for more details):

VARIABLE	DESCRIPTION
	EQ.-4: Switch material axes <i>b</i> and <i>c</i> before BETA rotation EQ.-3: Switch material axes <i>a</i> and <i>c</i> before BETA rotation EQ.-2: Switch material axes <i>a</i> and <i>b</i> before BETA rotation EQ.1: No change, default EQ.2: Switch material axes <i>a</i> and <i>b</i> after BETA rotation EQ.3: Switch material axes <i>a</i> and <i>c</i> after BETA rotation EQ.4: Switch material axes <i>b</i> and <i>c</i> after BETA rotation
V1, V2, V3	Components of vector v for AOPT = 3 and 4
D1, D2, D3	Components of vector d for AOPT = 2
BETA	Material angle in degrees for AOPT = 0 (shells and thick shells only) and AOPT = 3 (all element types). This angle may be overridden on the element card; see *ELEMENT_SHELL_BETA, *ELEMENT_TSHELL_BETA, and *ELEMENT_SOLID_ORTHO.
REF	Use reference geometry to initialize the stress tensor. The reference geometry is defined by the keyword: *INITIAL_FOAM_REFERENCE_GEOMETRY. EQ.0.0: Off EQ.1.0: On

Remarks:

1. **Volumetric Strain Energy Function.** The pure volumetric part of the strain energy function is defined as part of the ISOTropic module.
2. **Compressible and Nearly-Incompressible Models.** Depending on the sign of ITYPE and ATYPE, several formulations are available. Negative model numbers indicate that the corresponding part of the strain energy function is considered isochoric. Furthermore, the sign of FTYPE and INTYPE is directly linked to ATYPE. For example, if ATYPE is negative, both fiber and fiber interaction models are in their isochoric form. Consequently, compressible and nearly-incompressible anisotropy is obtained by using both INTYPE and ATYPE with or without a sign, respectively.
3. **Incompressibility Limit.** While there is no strict lower bound on the Poisson's ratio (ν_L), for nearly-incompressible materials, LS-DYNA will issue a warning message if $\nu < \nu_L = 0.49$.

4. **Special Cases of the Compressible/Nearly-Incompressible Ogden Model.** The following described special cases of the OGDEN Model (ITYPE = ± 1).
 - a) The (nearly-in)compressible neo-Hookean model is obtained as special case of ITYPE = (-)1 with $\mu_1 > 0$, $\alpha_1 = 1$.
 - b) The Mooney-Rivlin model is obtained as a special case of ITYPE = -1 with $\mu_i \alpha_i > 0$ for $i = 1, 2$, $\alpha_1 = 2$, and $\alpha_2 = -2$.
 - c) By setting $\beta = -1$ and ITYPE = -1, one obtains an equivalent formulation with *MAT_077_O.

5. **General Structure Tensor.** Considering the anisotropic part of the strain energy function, one may distinguish angular integration (AI) and general structure tensor (GST) based models. Owing to their numerical efficacy, currently all models in LS-DYNA rely on the general structure tensor [7], [8]. Parameters defining the structure tensor and fiber models need to be provided for each fiber family. Consequently, one may use different structure tensors and/or fiber models to describe the behavior of the individual fiber families.

The model proposed by Freed *et al.* [3] is a special case of the general structure tensor-based models assuming rotational symmetric fiber dispersion, determining the parameters A and B using a normal distribution, and invoking the fiber model introduced by Freed and Doehring [2].

6. **Fiber Families.** Characteristic material directions within the plane are defined by fiber families. The number of fiber families for INTYPE = 0 is currently limited to 3. If INTYPE = 1, the number of fiber families is limited to 2 that represent the fiber and sheet directions, respectively. The fiber and sheet directions form an orthonormal basis.

7. **Coupling (Quasi-)Invariants.** To further enhance the material model, coupling (quasi-) invariants associated with pairs of directions may be included in the strain-energy function. Following the formulation in Holzapfel and Ogden [7] and Eriksson *et al.* [1], a single coupling invariant defined between the orthonormal fiber and sheet directions is included with INTYPE = 1.

8. **Onset of Active Stress.** The input for this model gives you several different methods for triggering the activation and deactivation of the active stress development.
 - a) For ACTYPE = 1, 2, 3, and 4, T0 specifies the time at which active stress development is activated. This method does not include deactivation. The other methods take priority over setting T0.

- b) For all ACTYPE options, you can specify ACID and ACTHR. ACID represents the evolution of either the calcium ion concentration (ACTYPE = 1, 2, 3, or 5) or the transmembrane potential (ACTYPE = 4) over time. ACTHR is a threshold value for one of these quantities depending on ACTYPE. When the calcium ion concentration or transmembrane potential from the curve exceeds the threshold, the active stress development is activated. When it is less than the threshold, the active stress development is deactivated. With this method, the active stress development can be reactivated again when the value in the curve exceeds the threshold.
- c) For all ACTYPE methods, if you set up a coupled problem with the electrophysiology solver, ACTHR again gives the threshold value for the calcium ion concentration (ACTYPE = 1, 2, 3, or 5) or transmembrane potential (ACTYPE = 4). The electrophysiology solver provides the value to compare to the threshold to activate and deactivate the active stress development. As with ACID, the active stress development is activated when the value exceeds ACTHR and deactivates when the value is less than ACTHR. With this method, the active stress development can be reactivated again when the value exceeds the threshold.
9. **Active stress development.** Active stress is developed along direction(s) defined by ACDIR and may be scaled using the scaling factors SF, SS, and SN. For ACTYPE < 5, if SS and SN are zero, they are reset internally to ST.

Depending on ACDIR active stress may develop along one or multiple fiber families. Consider a single fiber family with unit fiber orientation vector \mathbf{e}_f . Let τ_A be the active stress. Then, the active stress tensor in the local fiber frame is:

$$\boldsymbol{\tau}_A = \tau_A (\text{SF } \mathbf{e}_f \otimes \mathbf{e}_f + \text{SS } \mathbf{e}_s \otimes \mathbf{e}_s + \text{SN } \mathbf{e}_n \otimes \mathbf{e}_n) .$$

Here \mathbf{e}_s and \mathbf{e}_n are the unit vectors in the sheet and normal directions that form a basis with \mathbf{e}_f .

If active tension develops along multiple fiber families, then the active stress tensor is:

$$\boldsymbol{\tau}_A = \sum_{i=1}^{\text{NF}} \boldsymbol{\tau}_{A_i} .$$

In the above NF is the number of fiber families and $\boldsymbol{\tau}_{A_i}$ is the active stress tensor for the i^{th} fiber family.

10. **Serial stress function.** The serial stress function needs to be expressed in terms of the fiber stretch λ and contractile stretch λ^{CE} . Thus, the elastic stretch in the serial element λ^{SE} needs to be eliminated using the multiplicative decomposition of the fiber stretch, that is, $\lambda = \lambda^{\text{CE}} \lambda^{\text{SE}}$.

11. **History Variables.** The history variables are listed in the table below. The default number of history variables depends on the used modules. If only the mandatory ISOtropic module is used, the number of history variables is 9. Including the ANISOtropic and ACTIVE modules in a hierarchical fashion yields an additional 12 and 9 history variables, that is, making the total number of history variables 21 and 30, respectively.

History Variable #	Definition
1-9	Deformation gradient (column-wise storage)
10-15	First two rows of the rotation matrix defining the material coordinate system a-b-c
16-18	Fiber stretch in each fiber family
19-21	Fiber stress in each fiber family
22-24	Active fiber stress in each fiber family
25	Calcium ion concentration at t^n if ACTYPE = 1,2,3,5) Transmembrane potential at t^n if ACTYPE = 4
26	Calcium ion concentration at t^{n-1} if AC- TYPE = 1,2,3,5) Transmembrane potential at t^{n-1} if ACTYPE = 4
27	Time since onset of activation
28-30	Contractile stretch in the dashpot at t^n if AC- TYPE = 5

References:

- [1] Eriksson T.S.E., Prassl A.J., Plank G., and Holzapfel G.A., Influence of myocardial fiber/sheet orientations on left ventricular mechanical contraction. *Mathematics and Mechanics of Solids* (2013) **18**:592-606
- [2] Freed A.D. and Doehring T.C., Elastic response of crimped collagen fibrils. *Journal of Biomechanical Engineering* (2005) **127**:587-593
- [3] Freed A.D., Einstein D.R., and Vesely I., Invariant formulation for dispersed transverse isotropy in aortic heart valves. *Biomechanics and Modeling in Mechanobiology* (2005) **4**:100-117

- [4] Guccione J.M., Waldman L.K., McCulloch A.D., Mechanics of active contraction in cardiac muscle: Part II – Cylindrical Models of the systolic left ventricle. *Journal of Biomechanical Engineering* (1993) **115**:82-90
- [5] Gültekin O., Sommer G., and Holzapfel G.A., An orthotropic viscoelastic model for the passive myocardium: continuum basis and numerical treatment. *Computer Methods in Biomechanics and Biological Engineering* (2016) **15**:1647-1664
- [6] Holzapfel G.A., Gasser T.C., and Ogden R.W., A new constitutive framework for arterial wall mechanics and a comparative study of material models. *Journal of Elasticity* (2000) **61**:1-48
- [7] Holzapfel G.A. and Ogden R.W., Constitutive modelling of passive myocardium: a structurally based framework for material characterization. *Philosophical Transactions of the Royal Society A* (2009) **367**:3445–3475
- [8] Holzapfel G.A., Niestrawska J.A., Ogden R.W., Reinisch A.J., and Schriefl A.J., Modelling non-symmetric collagen fibre dispersion in arterial walls. *Journal of the Royal Society Interface* (2015) **12**:1–14
- [9] Hunter P.J., Nash, M.P., and Sands, G.B., Computational Electromechanics of the Heart, *Computational Biology of the Heart*. John Wiley and Sons, London (1997) 346–407
- [10] Hunter P.J., McCulloch A.D., and ter Keurs H.E.D.J., Modelling the mechanical properties of cardiac muscle. *Progress in Biophysics and Molecular Biology* (1998) **69**:289–331
- [11] Nolan D.R., Gower A.L., Destrade M., Ogden R.W., and McGarry J.P., A robust anisotropic hyperelastic formulation for the modeling of soft tissue. *Journal of the Mechanical Behavior of Biomedical Materials* (2014) **29**:48-60
- [12] Ogden, R.W., Non-linear Elastic Deformations, *Dover Publishing Inc.*, New York (1997).
- [13] Yeoh O.H., Characterization of elastic properties of carbon-black filled rubber vulcanizates. *Rubber Chemistry and Technology* (1990) **63**:792-805
- [14] Martins J.A.C, Pato P.M.P, and Pires E.B, A finite element model of skeletal muscles, *Virtual and Physical Prototyping* (2006) **1**:159-170

***MAT_ANAND_VISCOPLASTICITY**

This is Material Type 296. This visco-plastic model by Professor Anand uses a set of evolution equations instead of loading-unloading criterion to describe dislocation motion and hardening or softening behavior of materials. This model can be applied to simulate solders used in electronic packaging.

Card 1	1	2	3	4	5	6	7	8
Variable	MID	RO	YM	PR	ALPHA	A1	RATIOQR	XI
Type	A8	F	F	F	F	F	F	F

Card 2	1	2	3	4	5	6	7	8
Variable	M	S0	H0	A2	SBAR	N		TREF
Type	F	F	F	F	F	F		F

VARIABLE**DESCRIPTION**

MID	Material identification. A unique number or label not exceeding 8 characters must be specified.
RO	Mass density
YM	Young's Modulus
PR	Poisson's ratio
ALPHA	Coefficient of thermal expansion, α
A1	Pre-exponential factor, A
RATIOQR	Ratio of the activation energy, Q (J/mol), to the universal gas constant, R (J/mol/K)
XI	Multiplier of stress, ζ
M	Strain rate sensitivity, m
S0	Initial value of deformation resistance, s_0

VARIABLE	DESCRIPTION
H0	Hardening/softening constant, H_0
A2	Strain rate sensitivity of hardening or softening, a
SBAR	Coefficient of deformation resistance saturation value, \bar{s}
N	Strain rate sensitivity of deformation resistance saturation value, n
TREF	Reference temperature, T_{ref}

Remarks:

In the Anand model, the equivalent stress σ is proportional to the deformation resistance s and depends upon the temperature T and the equivalent elastic strain $\dot{\epsilon}^p$ as

$$\sigma = c(T, \dot{\epsilon}^p) s ,$$

where c is a material parameter defined by

$$c = \frac{1}{\xi} \sinh^{-1} \left[\left(\frac{\dot{\epsilon}^p}{A} \exp\left(\frac{Q}{RT}\right) \right)^m \right] .$$

The material parameter c depends on material constants defined in the variable list above and the universal gas constant R .

The above equations can be rearranged to express the equivalent inelastic strain rate $\dot{\epsilon}^p$ in terms σ , T , and s as

$$\dot{\epsilon}^p = A \exp\left(-\frac{Q}{RT}\right) \left[\sinh\left(\xi \frac{\sigma}{s}\right) \right]^{1/m} .$$

This is called the flow equation.

The rate of deformation resistance \dot{s} is defined as

$$\dot{s} = H \dot{\epsilon}^p ,$$

where

$$H = H_0 \left| 1 - \frac{s}{s_s} \right|^a \operatorname{sign} \left(1 - \frac{s}{s_s} \right) .$$

In the above equation, s_s is the deformation resistance saturation value which is defined as

$$s_s = \bar{s} \left[\frac{\dot{\epsilon}^p}{A} \exp\left(\frac{Q}{RT}\right) \right]^n .$$

With the equivalent inelastic strain rate $\dot{\epsilon}^p$, the inelastic strain components can be computed based on a normality hypothesis of the Prandtl-Reuss flow law:

$$\dot{\epsilon}^p = \sqrt{\frac{3}{2}} \dot{\epsilon}^p \mathbf{N} .$$

In the above equation, the direction of plastic flow \mathbf{N} is defined as

$$\mathbf{N} = \sqrt{\frac{3}{2}} \frac{\mathbf{S}}{\sigma} ,$$

where \mathbf{S} is the deviatoric part of the stress σ .

The Cauchy Stress \mathbf{T} for this model is

$$\mathbf{T} = J^{e-1} \mathbf{R}^e \mathbf{M}^e \mathbf{R}^{eT} ,$$

where

$$\mathbf{M}^e = \mathbf{C}[\mathbf{E}^e - \alpha(T - T_0)] .$$

T_0 is the initial temperature. \mathbf{C} is defined as

$$\mathbf{C} \stackrel{\text{def}}{=} 2G \left(\mathbb{I}^s - \frac{1}{3} \mathbf{I} \otimes \mathbf{I} \right) + K \mathbf{I} \otimes \mathbf{I} .$$

References:

- [1] Brown, Stuart B., Kwon H. Kim, and Lallit Anand. "An internal variable constitutive model for hot working of metals." International journal of plasticity 5.2 (1989): 95-130.
- [2] Lallit Anand, Constitutive equations for hot-working of metals, International Journal of Plasticity, (1985), 213-231.

***MAT_DMN_COMPOSITE_FRC**

This is Material Type 303. It is a machine learning-based multiscale material model for analysis of injection-molded fiber-reinforced composites (FRC). The multiscale material model can predict the macroscopic material responses (stress, equivalent plastic strain, etc.) based on the microscopic material information. To use this material model, you need to provide the geometric descriptors for material microstructures (i.e., fiber orientation tensor, fiber volume fraction, etc.) and the material properties of each base material (i.e., fiber and matrix), respectively. In the current version, only certain constitutive laws described in [Remarks 2](#) and [3](#) are supported for the base materials. To obtain the geometrical information for the microstructures, you can use an injection molding simulation software, such as Moldex3D. LS-PrePost can be used to import the injection molding results into LS-DYNA models (see [Remark 4](#) and [Workflow to import fiber data from Moldex3D](#)).

This model is available in R14 or newer versions of MPP/SMP double precision LS-DYNA. Currently, this 3D multiscale material model supports explicit dynamic finite element analysis using eight-node hexahedron solid elements, four-node tetrahedron solid elements, and type 25 four-node shell elements.

Card Summary:

Card 1. This card is required.

MID							
-----	--	--	--	--	--	--	--

Card 2. This card is required.

FVF	RO	RF	RM	FL	FD		
-----	----	----	----	----	----	--	--

Card 3. This card is required.

F_E	F_PR	ISO					
-----	------	-----	--	--	--	--	--

Card 3.1. This card is included if ISO = 1 in Card 3.

F_EL	F_ET	F_PRTL	F_PRTT	F_GLT			
------	------	--------	--------	-------	--	--	--

Card 4. This card is required.

M_E	M_PR	M_SY	M_H1	M_H2	M_H3	ITC	
-----	------	------	------	------	------	-----	--

Card 4.1. This card is included if ITC = 1 in Card 4.

M_EC	M_PRC	M_SYC	M_H1C	M_H2C	M_H3C	PT	PC
------	-------	-------	-------	-------	-------	----	----

Card 5. This card is required.

LCIDT	LCIDC							
-------	-------	--	--	--	--	--	--	--

Data Card Definitions:

Card 1	1	2	3	4	5	6	7	8
Variable	MID							
Type	A							
Default	none							

VARIABLE

DESCRIPTION

MID

Material identification. A unique number or label must be specified (see *PART).

Card 2	1	2	3	4	5	6	7	8
Variable	FVF	RO	RF	RM	FL	FD		
Type	F	F	F	F	F	F		
Default	none	none	none	none	none	none		

VARIABLE

DESCRIPTION

FVF

ϕ^f , fiber volume fraction. If RF and RM are given, a nonzero FVF must be specified to calculate the mass density of the overall fiber-reinforced composite. This value can be overwritten by *INITIAL_STRESS_SHELL or *INITIAL_STRESS_SOLID. See Remark 4.

RO

ρ^c , mass density of the overall fiber-reinforced composite. This value will be neglected if RF and RM are given, respectively.

RF

ρ^f , mass density of the fiber phase

VARIABLE	DESCRIPTION							
RM	ρ^m , mass density of the matrix phase							
FL	Fiber length. Alternatively, if you want to specify the fiber aspect ratio, set FL to the fiber aspect ratio and FD to 1.0.							
FD	Fiber diameter. Alternatively, if you want to directly specify the fiber aspect ratio, set FD to 1.0 and FL to the fiber aspect ratio.							

Card 3	1	2	3	4	5	6	7	8
Variable	F_E	F_PR	ISO					
Type	F	F	I					
Default	none	none	0					

VARIABLE	DESCRIPTION							
F_E	E^f , Young's modulus of the fiber phase if the fiber property is isotropic. See Remark 2 .							
F_PR	ν_{H}^f , Poisson's ratio of the fiber phase if the fiber property is isotropic.							
ISO	Flag for anisotropy of the fiber phase: EQ.0: Isotropic fiber material property EQ.1: Transversely isotropic fiber material property							

Transversely Isotropic Fiber Material Card. Include this card if ISO = 1 on Card 3.

Card 3.1	1	2	3	4	5	6	7	8
Variable	F_EL	F_ET	F_PRTL	F_PRTT	F_GLT			
Type	F	F	F	F	F			
Default	none	none	none	none	none			

VARIABLE	DESCRIPTION
F_EL	E_l^f , Young's modulus of the fiber phase along the fiber's longitudinal direction, l . See Remark 2 .
F_ET	E_t^f , Young's modulus of the fiber phase along the fiber's transverse direction t . Note that the transversely isotropic model becomes isotropic by setting $E_t^f = E_l^f$, $\nu_{tt}^f = \nu_{tl}^f$, and $G_{tt}^f = E_l^f / [2(1 + \nu_{tl}^f)]$.
F_PRTL	ν_{tl}^f , Poisson's ratio of the fiber phase
F_PRTT	ν_{tt}^f , Poisson's ratio of the fiber phase. Note that the transversely isotropic model becomes isotropic by setting $E_t^f = E_l^f$, $\nu_{tt}^f = \nu_{tl}^f$, and $G_{tt}^f = E_l^f / [2(1 + \nu_{tl}^f)]$.
F_GLT	G_{lt}^f , shear modulus of the fiber phase in the lt direction. Note that the transversely isotropic model becomes isotropic by setting $E_t^f = E_l^f$, $\nu_{tt}^f = \nu_{tl}^f$, and $G_{lt}^f = E_l^f / [2(1 + \nu_{tl}^f)]$.

Card 4	1	2	3	4	5	6	7	8
Variable	M_E	M_PR	M_S1	M_S2	M_S3	M_S4	ITC	
Type	F	F	F	F	F	F	I	
Default	none	none	none	none	none	none	0	

VARIABLE	DESCRIPTION
M_E	E^m , Young's modulus of the matrix phase. See Remark 3 .
M_PR	ν^m , Poisson's ratio of the matrix phase
M_S1	s_1^m , plastic yielding parameter of the matrix phase
M_S2	s_2^m , plastic yielding parameter of the matrix phase
M_S3	s_3^m , plastic yielding parameter of the matrix phase
M_S4	h_0^m , plastic yielding parameter of the matrix phase

VARIABLE	DESCRIPTION
ITC	Option for the elastoplastic material law for the matrix phase. EQ.0: No tension-compression asymmetry in material properties EQ.1: Use tension-compression asymmetric material properties

Tension-Compression Asymmetry Card. This card is included if ITC = 1.

Card 4.1	1	2	3	4	5	6	7	8
Variable	M_EC	M_PRC	M_S1C	M_S2C	M_S3C	M_S4C	PT	PC
Type	F	F	F	F	F	F	F	F
Default	none	none	none	none	none	none	0.0	0.0

VARIABLE	DESCRIPTION
M_EC	E^m , Young's modulus of the matrix phase in compression
M_PRC	ν^m , Poisson's ratio of the matrix phase in compression
M_S1C	s_1^m , plastic yielding parameter of the matrix phase in compression
M_S2C	s_2^m , plastic yielding parameter of the matrix phase in compression
M_S3C	s_3^m , plastic yielding parameter of the matrix phase in compression
M_S4C	h_0^m , plastic yielding parameter of the matrix phase in compression
PT	Absolute value of the tensile mean stress threshold beyond which the tensile material properties are adopted. If the mean stress $(\sigma_{XX} + \sigma_{YY} + \sigma_{ZZ})/3$ falls within the range $[-PC, PT]$, a weighted average of the tensile and compressive material properties is used for the matrix phase. See Remark 3 .
PC	Absolute value of the compressive mean stress threshold beyond which compressive material properties are adopted.

Card 5	1	2	3	4	5	6	7	8
Variable	LCIDT	LCIDC						
Type	I	I						
Default	0	0						

VARIABLE**DESCRIPTION**

LCIDT

ID for an optional load curve (see *DEFINE_CURVE) giving the yield strength for the matrix (second column) as a function of accumulated equivalent plastic strain of the matrix (first column). If ITC = 1 is specified in Card4, then this load curve describes the matrix material in tension only. See [Remark 3](#).

LCIDC

ID for an optional load curve that is only used if ITC = 1 on Card 4. This curve gives the yield strength for the matrix (second column) as a function of accumulated equivalent plastic strain of the matrix (first column) in compression. See [Remark 3](#).

Remarks:

1. **Mechanistic machine learning-based multiscale simulation.** The core algorithm of this multiscale simulation is the DMN (Deep Material Network) based upon a mechanistic machine learning technique [1, 2, 3, 4, 5]. As described in [4, 5], the machine learning model creation requires an “offline” training process, which involves the learning of composite material physics hidden in the high-fidelity RVE simulation-based data. To cover a wide variety of material microstructures of fiber-reinforced composites, we adopted a transfer learning method [3, 4] to generate different networks based on the actual material microstructure information at each integration point of the finite element mesh. In LS-DYNA, we have implemented a trained DMN database. It can effectively predict the highly nonlinear macroscopic material behaviors. The computational cost of DMN is orders-of-magnitude lower than finite element simulation of high-fidelity 3D RVEs containing complex material microstructures. The overall concurrent multiscale simulation framework enabled by DMN is depicted in [Figure M303-1](#).

Different from conventional material models, this machine learning-based multiscale material model is data-driven, so its simulation capability can be continuously enhanced as more high-quality training data for fiber-reinforced

composites are supplied in the future. Enhanced DMN databases with new functions will be available in the future release of LS-DYNA.

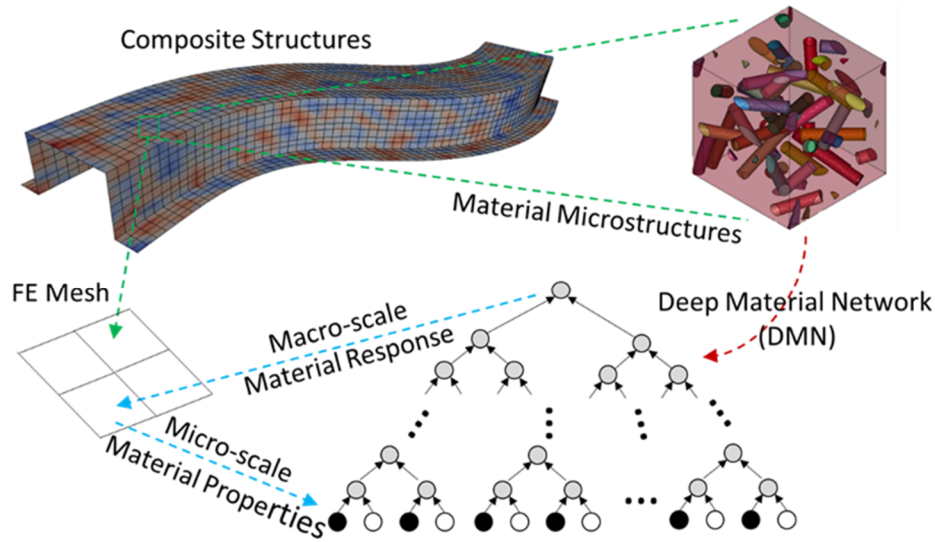

Figure M303-1. Schematic of the simulation framework for concurrent multiscale nonlinear analysis of injection-molded fiber-reinforced composite structures.

2. **Constitutive laws for fiber materials.** By default, the constitutive behaviors of the fiber material are modeled with isotropic elasticity. If you set ISO to 1 on Card 3, then the fiber material is modeled with a transversely isotropic elasticity. Its symmetric compliance matrix takes the following form:

$$\begin{bmatrix} 1/E_l^f & -\nu_{tl}^f/E_t^f & -\nu_{tl}^f/E_t^f & 0 & 0 & 0 \\ -\nu_{tl}^f/E_t^f & 1/E_t^f & -\nu_{tt}^f/E_t^f & 0 & 0 & 0 \\ -\nu_{tl}^f/E_t^f & -\nu_{tt}^f/E_t^f & 1/E_t^f & 0 & 0 & 0 \\ 0 & 0 & 0 & 1/G_{lt}^f & 0 & 0 \\ 0 & 0 & 0 & 0 & 2(1 + \nu_{tl}^f)/E_l^f & 0 \\ 0 & 0 & 0 & 0 & 0 & 1/G_{lt}^f \end{bmatrix}$$

Here E_l^f and E_t^f are the Young’s moduli along the fiber’s longitudinal (l) and transverse (t) directions, respectively; ν_{tl}^f and ν_{tt}^f are the Poisson’s ratios; and G_{lt}^f is the shear modulus. If the five material parameters given in Card 3.1 satisfy $E_l^f = E_t^f$, $\nu_{tl}^f = \nu_{tt}^f$, and $G_{lt}^f = E_l^f / [2(1 + \nu_{tl}^f)]$, then the elastic fiber’s material model becomes isotropic which is the same as simply providing the two material constants in Card 3.

3. **Constitutive laws for matrix materials.** The matrix materials are model with an associated elastoplastic constitutive model. If ITC = 0 in Card 4, then the

material properties given in Card 4 and/or LSIDT in Card 5 will be used for the matrix material, and Card 4.1 should not appear in the input file. However, if $ITC = 1$ is specified in Card 4, then tension-compression asymmetry will be considered for the matrix material. In this case, Card 4 and/or LCIDT specify tensile material properties while Card 4.1 and/or LCIDC specify compressive material properties. By default, tension is determined by the sign of the mean stress $(\sigma_{XX} + \sigma_{YY} + \sigma_{ZZ})/3$, where a positive sign indicates that the material is in tension. Numerically, an abrupt transition from the tensile and compressive yield surfaces may cause convergence difficulty. To avoid this numerical issue, we can assign small positive numbers (e.g., a small percentage of the yield strength) to PT and PC in Card 4.1 which define a mean stress range $[-PC, PT]$ for which weighted averaged values of the tensile and compressive properties are used in the simulation.

Two von Mises yield functions with different hardening laws are available, including:

- a) A yield function based on the following isotropic hardening law:

$$s_Y^m = s_1^m + s_2^m \bar{\epsilon}_P^m - s_3^m \exp(-h_0^m \bar{\epsilon}_P^m)$$

where s_Y^m denotes the current yield strength for the matrix phase, $\bar{\epsilon}_P^m$ denotes the accumulated equivalent plastic strain of the matrix material, and plastic yielding parameters h_0^m , s_1^m , s_2^m , and s_3^m are defined in Card 4 or Card 4.1. If $s_3^m = 0$, the yield function becomes equivalent to a linear hardening law with a hardening coefficient s_2^m an initial yield strength s_1^m . Otherwise, $s_1^m - s_3^m$ represents the initial yield strength.

- b) A yield function based on an input hardening curve. The curve ID is given as LCIDT or LCIDC in Card 5, where the curve data's first and second columns represent, respectively, the accumulated equivalent plastic strain, $\bar{\epsilon}_P^m$, and the corresponding yield strength, s_Y^m .

If a hardening curve is provided in Card 5, then the corresponding hardening parameters defined in Card 4 or Card 4.1 will be ignored. In other words, if nonzero LCIDT is specified, then the initial yield strength and hardening parameters given in Card 4 are ignored. Similarly, if nonzero LCIDC is specified, then the initial yield strength and hardening parameters given in Card 4 are ignored in the simulation.

Based on feedback and requests, we will develop other constitutive laws for the base materials to capture more complex behaviors of composites, such as material failures.

4. **Heterogeneous distributions of fiber orientations and fiber volume fractions.** Due to the manufacturing process, fiber-reinforced composites contain heterogeneous distributions of material microstructures, such as different fiber

```

...
$
*END
$
$$$$$$$$$$$$$$$$$$$$$$$$$$$$$$$$$$$$$$$$$$$$$$$$$$$$$$$$$$$$$$$$$$$$$$$$$$$$$$$$$$$$$$$$$$$$

```

b) If shell finite elements (shell formulation 25 that supports the use of 3D constitutive laws) are used, the *INITIAL_STRESS_SHELL keyword can be used to define the fiber information. If we assume that the one-point quadrature scheme is adopted in the in-plane direction while 3 integration points exist along the shell thickness direction (note: you can define the number of through-thickness integration points), then we need to define 6 history variables at each of the 3 integration points of every shell finite element. These history variables include the components of the symmetric fiber orientation tensor, $(A_{XX})_e^p$, $(A_{YY})_e^p$, $(A_{XY})_e^p$, $(A_{YZ})_e^p$, $(A_{XZ})_e^p$, and the fiber volume fraction, $(fvf)_e^p$. The subscript $e = 1, 2, 3, \dots$ denotes the finite element index, and the superscript $p = 1, 2, 3, \dots$ denotes the integration point index. Please refer to the following example.

```

$$$$$$$$$$$$$$$$$$$$$$$$$$$$$$$$$$$$$$$$$$$$$$$$$$$$$$$$$$$$$$$$$$$$$$$$$$$$$$$$$$$$$$$$$$$$
$
$$$ Define Fiber Information in *INITIAL_STRESS_SHELL
$
$$$$$$$$$$$$$$$$$$$$$$$$$$$$$$$$$$$$$$$$$$$$$$$$$$$$$$$$$$$$$$$$$$$$$$$$$$$$$$$$$$$$$$$$$$$$
$
*KEYWORD
$
$. . . > . . . 1 . . . > . . . 2 . . . > . . . 3 . . . > . . . 4 . . . > . . . 5 . . . > . . . 6 . . . > . . . 7 . . . > . . . 8
*INITIAL_STRESS_SHELL
$      EID      NPLANE      NTHICK      NHISV      NTENSR      LARGE
$      e            1            3            6            0            1
$ . . . > . . . . 1 . . . > . . . . 2 . . . > . . . . 3 . . . > . . . . 4 . . . > . . . . 5
$      T            SIGXX            SIGYY            SIGZZ            SIGXY
$      -0.77459      0.0            0.0            0.0            0.0
$      SIGYZ            SIGZX            EPS
$      0.0            0.0            0.0
$      HISV1            HISV2            HISV3            HISV4            HISV5
$      (AXX)e1      (AYY)e1      (AXY)e1      (AYZ)e1      (AXZ)e1
$      HISV6
$      (fvf)e1
$      T            SIGXX            SIGYY            SIGZZ            SIGXY
$      0.00000      0.0            0.0            0.0            0.0
$      SIGYZ            SIGZX            EPS
$      0.0            0.0            0.0
$      HISV1            HISV2            HISV3            HISV4            HISV5
$      (AXX)e2      (AYY)e2      (AXY)e2      (AYZ)e2      (AXZ)e2
$      HISV6
$      (fvf)e2
$      T            SIGXX            SIGYY            SIGZZ            SIGXY
$      0.77459      0.0            0.0            0.0            0.0
$      SIGYZ            SIGZX            EPS
$      0.0            0.0            0.0
$      HISV1            HISV2            HISV3            HISV4            HISV5
$      (AXX)e3      (AYY)e3      (AXY)e3      (AYZ)e3      (AXZ)e3
$      HISV6
$      (fvf)e3

```

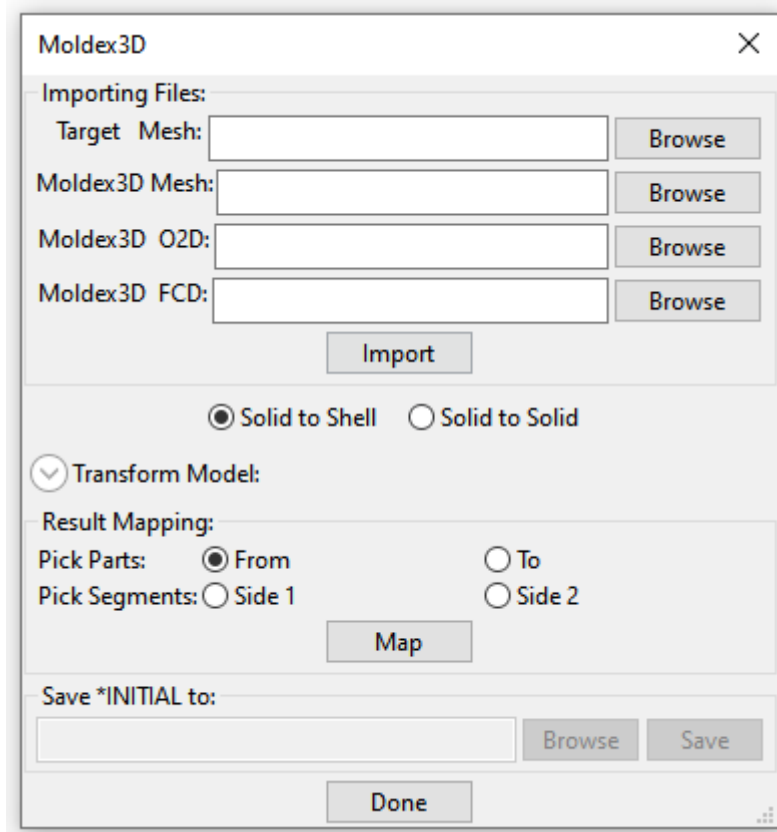



Figure M303-2. Moldex3D mapping GUI in LS-PrePost 4.9 (available in March 2022).

coordinates for the ‘source’ parts that are used in the injection molding analysis in Moldex3D.

4. Click the *Browse* button under *Moldex3D O2D* and select the .o2d file exported from Moldex3D. The .o2d file contains the fiber orientation tensor distribution in the ‘source’ part.
5. Click the *Browse* button under *Moldex3D FCD* and select the .fcd file exported from Moldex3D. The .fcd file contains the fiber concentration (meaning fiber volume fraction $\times 100$) distribution in the ‘source’ part. If the .fcd file is not available, then this step can be skipped, and the fiber volume fraction distribution will be considered homogeneous in the target part based on the parameter FVF given in *MAT_DMN_COMPOSITE_FRC.
6. Click *Import* so that all the previously selected files will be read in LS-PrePost. The source model and the target model are both visualized in the same global coordinate system, as shown in [Figure M303-3](#).
7. Choose “Solid to Shell”, if the target part is discretized by shell finite elements. Alternatively, choose “Solid to Solid”, if the target part is discretized by solid

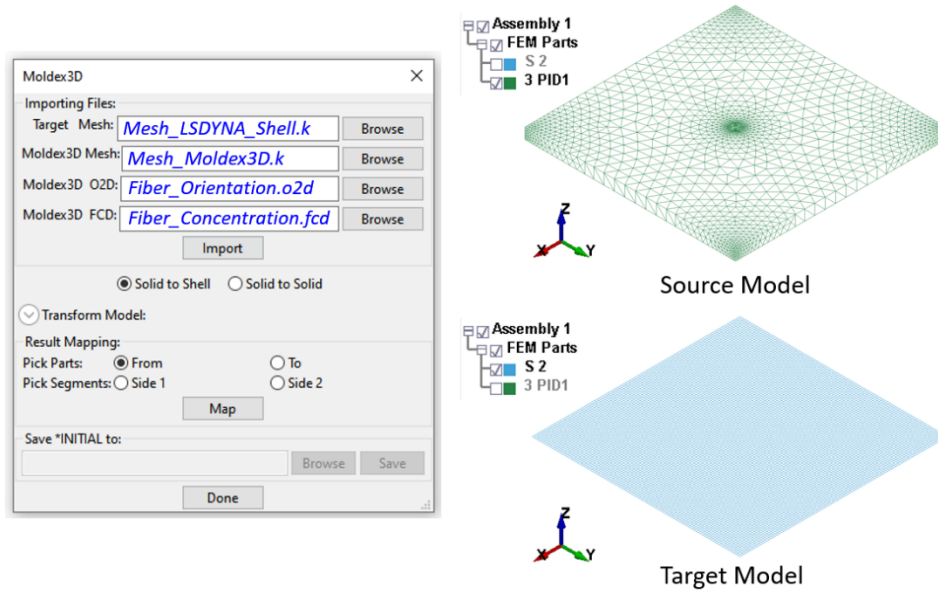

Figure M303-3. After importing the files chosen in steps 2-5, the source model and target model will be visualized automatically in the same global coordinate system in LS-PrePost v4.9. In this illustration, the source model is discretized by solid finite elements, and the target model is discretized by shell finite elements.

finite elements. Note that, in the current LS-PrePost mapping function, only solid elements can be used as the source part from Moldex3D.

8. If the source part and the target part are oriented in the same direction in the global coordinate system, then this step should be skipped. Otherwise, a rigid body rotation should be performed to rotate the source part into the same orientation as the target part. To do so, as shown in [Figure M303-4](#), click “Transform Model”, and select three nodes in the source model that define a plane (plane A), and then select three nodes in the target model that define a plane (plane B). LS-PrePost then automatically applies a 3D rigid body rotation that transforms plane A to plane B when it maps the fiber information from the source part to the target part in subsequent steps.
9. In “Pick Parts”, click “From”, then select the part from the Moldex3D source model.
10. In “Pick Parts”, click “To”, then select the part from the LS-DYNA target model.

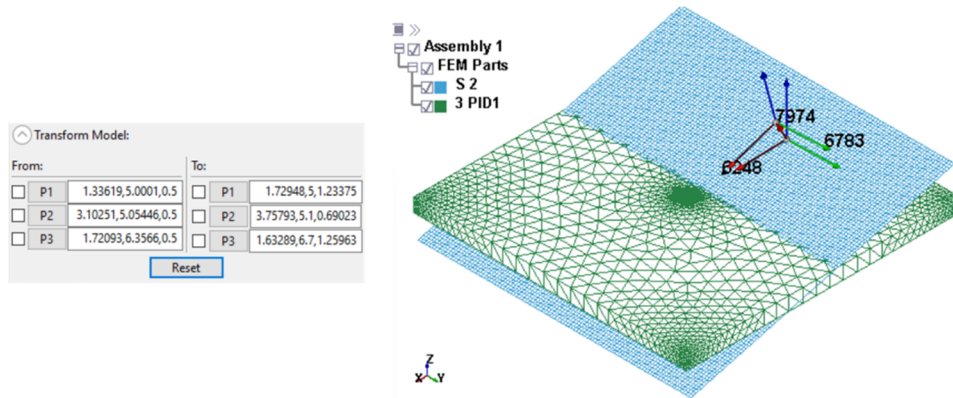

Figure M303-4. The source part and the target part are not always oriented in the same direction in the global coordinate system, but mapping fiber information in LS-PrePost requires that the rigid body transformation between the parts be known. With “Transform Model”, you define planes in the source and target so that the rigid body rotation can be determined.

11. If “Solid to Solid” is chosen in Step 8, then skip this step. Otherwise, in “Pick Segments”, select two surfaces from the source part as “Side 1” and “Side 2”, as shown in Figure M303-5. These two surfaces of the solid model should, respectively, correspond to the top and bottom surfaces of shell finite element mesh in the target part.

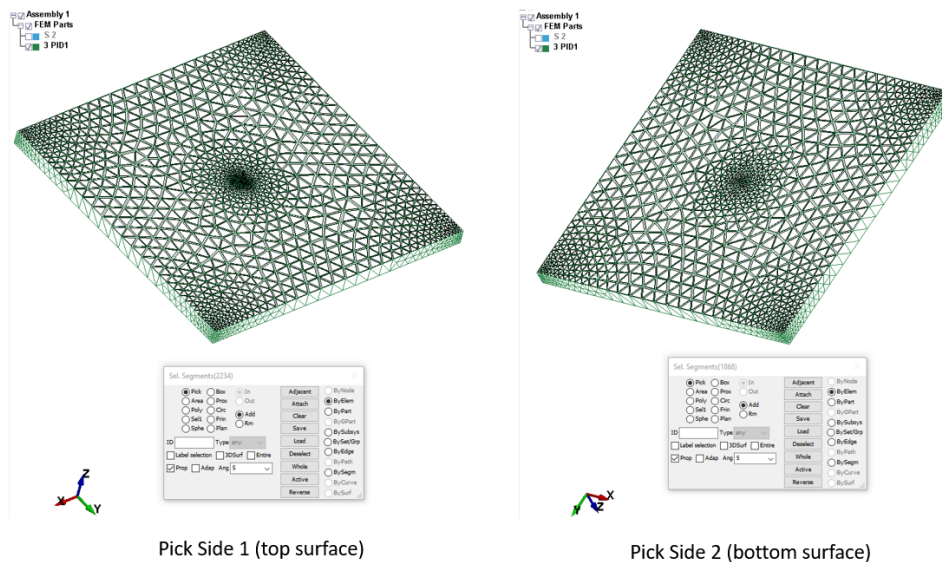

Figure M303-5. For the “Solid to Shell” mapping, select two opposite sides of the source part that correspond to the top and bottom surfaces of the target shell model.

12. If “Solid to Shell” is chosen in Step 8, the number of through-thickness integration points defined in the keyword card *SECTION_SHELL for shell finite

elements in the target part will be recognized automatically by LS-PrePost. If the number of through-thickness integration points is not defined for the target part, 3 through-thickness integration points will be used by LS-PrePost in the solid-to-shell mapping.

13. Click “Map” to map the data from the source part to the target part.
14. Under “Save *INITIAL to”, click “Browser” to specify the path and filename for the new keyword file. Then click “Save” so that the keyword cards *INITIAL_STRESS_SHELL or *INITIAL_STRESS_SOLID will be created in the specified file. This file should be included for the LS-DYNA finite element analysis.
15. Click “Done” to exit the Moldex3D mapping function.
16. Click “Post”, choose “Fringe Component”, and select either the source part or the target part to view contour plots of the original data or mapped data, respectively.

References:

- [1] Liu, Z., C.T. Wu, and M. Koishi, “A deep material network for multiscale topology learning and accelerated nonlinear modeling of heterogeneous materials,” *Computer Methods in Applied Mechanics and Engineering*, Vol. 345, pp. 1138-1168, (2019).
- [2] Liu, Z. and C.T. Wu, “Exploring the 3D architectures of deep material network in data-driven multiscale mechanics,” *Journal of the Mechanics and Physics of Solids*, Vol. 127, pp. 20-46, (2019).
- [3] Liu, Z., C.T. Wu, and M. Koishi, “Transfer learning of deep material network for seamless structure-property predictions,” *Computer Mechanics*, Vol. 64, pp. 451-465, (2019).
- [4] Liu, Z., H. Wei, T. Huang, and C.T. Wu, “Intelligent multiscale simulation based on process-guided composite database,” (2020). <https://arxiv.org/abs/2003.09491>
- [5] Wei, H., C.T. Wu, D. Lyu, W. Hu, F.H. Rouet, K. Zhang, P. Ho, H. Oura, M. Nishi, T. Naito, and L. Shen, “Multiscale simulation of short-fiber-reinforced composites from computational homogenization to mechanistic machine learning in LS-DYNA,” 13th European LS-DYNA Conference, Ulm, Germany (2021). Vol. 64, pp. 451-465, (2019). <https://www.dynalook.com/conferences/13th-european-ls-dyna-conference-2021>

*MAT_HOT_PLATE_ROLLING

This is Material Type 305. This model is for hot rolling of steel. It can only be used with solid elements for explicit simulation. The model contains the following features: work hardening, dynamic softening, static recovery, and static recrystallization. Input parameters are calibrated from Gleeble tests at various deformation rates and temperatures; see Schill et. al. [2021] and references therein.

Card Summary:

Card 1. This card is required.

MID	RO	E	PR	ALPHAT	BETA	VP	TOL
-----	----	---	----	--------	------	----	-----

Card 2. This card is required.

YB	QDEF	R	A	B	MINRT	POST	ODESOL
----	------	---	---	---	-------	------	--------

Card 3. This card is required.

ASIGO	BSIGO	ASIGS	BSIGS	ASIGSS	BSIGSS	AEPS	BEPS
-------	-------	-------	-------	--------	--------	------	------

Card 4. This card is required.

THRES	M	ALPHA	NUD	U0	K	NU	BNU
-------	---	-------	-----	----	---	----	-----

Card 5. This card is required.

T50	N	A50	D	GSF	P	Q	QREX
-----	---	-----	---	-----	---	---	------

Data Card Definitions:

Card 1	1	2	3	4	5	6	7	8
Variable	MID	RO	E	PR	ALPHAT	BETA	VP	TOL
Type	A	F	F	F	F	F	F	F
Default	none	none	none	none	none	0.0	0.0	1.0

VARIABLE	DESCRIPTION
MID	Material identification. A unique number or label must be specified (see*PART).
RO	Mass density
E	Young's modulus
PR	Poisson's ratio
ALPHAT	Thermal expansion coefficient, α_T .
BETA	Mixed hardening parameter, $0 \leq \beta \leq 1$. $\beta = 0$ for isotropic and $\beta = 1$ for kinematic hardening.
VP	Formulation for rate effects in plasticity update: EQ.0.0: No plastic strain rate dependence in yield stress (default) EQ.1.0: Plastic strain rate dependence in yield stress. Slower but more stable (recommended).
TOL	Multiplication factor (must be > 0.0) on tolerance criteria for plasticity and annealing iterations. LT.1.0: Increases accuracy at greater computational cost EQ.1.0: Default value GT.1.0: Decreases accuracy at less computational cost

Work Hardening and Dynamic Softening Parameters Card.

Card 2	1	2	3	4	5	6	7	8
Variable	YB	QDEF	R	A	B	MINRT	POST	ODESOL
Type	F	F	F	F	F	F	F	F
Default	none	none	none	none	none	0.0	0.0	0.0

VARIABLE	DESCRIPTION
BY	Work hardening parameter, B_y . See Work Hardening and Dynamic Softening .

VARIABLE	DESCRIPTION
QDEF	Work hardening activation energy, Q_{def} . See Work Hardening and Dynamic Softening .
R	Work hardening gas constant, R . See Work Hardening and Dynamic Softening .
A	Dynamic softening parameter, a . See Work Hardening and Dynamic Softening .
B	Dynamic softening parameter, b . See Work Hardening and Dynamic Softening .
MINRT	Work hardening minimum (plastic) strain rate, $\dot{\epsilon}_{\text{min}}$, in Zener-Hollomon parameter. See Work Hardening and Dynamic Softening .
POST	Save additional history variables for post-processing with POST = 1
ODESOL	Solver for static recovery stress: EQ.0.0: Trapezoidal rule (default) EQ.1.0: Heun's method: Faster but less stable.

Second Work Hardening and Dynamic Softening Parameters Card.

Card 3	1	2	3	4	5	6	7	8
Variable	ASIG0	BSIG0	ASIGS	BSIGS	ASIGSS	BSIGSS	AEPS	BEPS
Type	F	F	F	F	F	F	F	F
Default	none	none	none	none	none	none	none	none

VARIABLE	DESCRIPTION
ASIG0, ASIGS	Parameters a_i , $i = 0, s, ss$, to calculate σ_0 , σ_s , and σ_{ss} , respectively, from the Zener-Hollomon parameter. See Work Hardening and Dynamic Softening .
BSIG0, BSIGS	Parameters b_i , $i = 0, s, ss$, to calculate σ_0 , σ_s , and σ_{ss} , respectively, from the Zener-Hollomon parameter. See Work Hardening and Dynamic Softening .

VARIABLE	DESCRIPTION
AEPS	Parameter a_{ϵ_s} used to calculate the saturation strain, ϵ_s , for dynamic relaxation from the Zener-Hollomon parameter. See Work Hardening and Dynamic Softening .
BEPS	Parameter a_{ϵ_s} used to calculate the saturation strain, ϵ_s , for dynamic relaxation from the Zener-Hollomon parameter. See Work Hardening and Dynamic Softening .

Static Recovery Parameters Card. See [Static Recovery and Static Recrystallization](#).

Card 4	1	2	3	4	5	6	7	8
Variable	THRES	M	ALPHA	NUD	U0	K	NU	BNU
Type	F	F	F	F	F	F	F	F
Default	none	none	none	none	none	none	none	none

VARIABLE	DESCRIPTION
THRES	Static recovery strain rate threshold. THRES > 0 turns off dynamic softening, meaning sets A = 0.
M	Taylor factor, M , for static recovery stress
ALPHA	α parameter for static recovery stress
NUD	Debye frequency, ν_D , for static recovery stress
U0	Activation energy, U_0 , for static recovery stress
K	Boltzmann constant, k
NU	Interaction volume, ν , for static recovery stress
BNU	Burger's vector, b_{ν} , for static recovery stress

Static Recrystallization Parameters Card. See [Static Recovery](#) and [Static Recrystallization](#).

Card 5	1	2	3	4	5	6	7	8
Variable	T50	N	A50	D	GSF	P	Q	QREX
Type	F	F	F	F	F	F	F	F
Default	none	none	none	none	none	none	none	none

VARIABLE**DESCRIPTION**

T50	Time required to reach 50% static recrystallization
N	Static recrystallization exponent
A50	Scale parameter for strain dependent recrystallization time: EQ.0.0: T50 parameter is used for recrystallization time. GT.0.0: T50 parameter is ignored. Recrystallization time is calculated with A50, D, GSF, P, Q, and QREX. LT.0.0: T50 parameter is used. Recrystallization factor and combined recovery stress calculated using A50, D, GSF, P, Q, QREX are additional history variables if POST = 1.
D	Length parameter for strain dependent recrystallization time
GSF	Exponent for strain dependent recrystallization time
P	Exponent for strain dependent recrystallization time
Q	Exponent for strain dependent recrystallization time
QREX	Activation energy for strain dependent recrystallization time

Material Model:

This material model uses a hypo-elastoplastic formulation

$$\dot{\sigma} = \mathbf{C}\dot{\epsilon}_e = \mathbf{C}(\dot{\epsilon} - \dot{\epsilon}_T - \dot{\epsilon}_p) ,$$

with thermal strain rate

$$\dot{\epsilon}_T = \alpha_T \dot{T} \mathbf{I} ,$$

and plastic strain rate

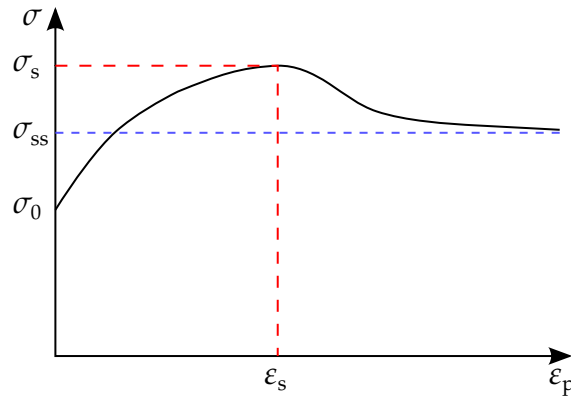

Figure M305-1. Stress-strain with work hardening and dynamic softening

$$\dot{\epsilon}_p = \dot{\epsilon}_p \frac{3 \mathbf{s} - \boldsymbol{\alpha}}{2 \sigma_{VM}} ,$$

where \mathbf{s} is the deviatoric stress, $\boldsymbol{\alpha}$ is the back stress, ϵ_p is the effective plastic strain, and

$$\sigma_{VM} = \sqrt{\frac{3}{2} (\mathbf{s} - \boldsymbol{\alpha}) : (\mathbf{s} - \boldsymbol{\alpha})} ,$$

is the Von Mises stress.

Using a mixed kinematic isotropic-kinematic hardening with mixing factor $\beta \in [0,1]$ and a nonlinear hardening function $h(T, \epsilon_p, \dot{\epsilon}_p)$, the back stress evolves according to

$$\dot{\boldsymbol{\alpha}} = \beta H \dot{\epsilon}_p \frac{\mathbf{s} - \boldsymbol{\alpha}}{\sigma_{VM}} ,$$

where $H = \partial h / \partial \epsilon_p$ is the material hardening. The yield stress becomes

$$\sigma_y = h + \beta(\sigma_0 - h) ,$$

where σ_0 is the initial yield stress. We will discuss the nonlinear hardening function in [Work Hardening and Dynamic Softening](#) below.

We will next discuss the models for work hardening, dynamic recrystallization, static recovery, and static recrystallization.

Work Hardening and Dynamic Softening

To begin this discussion, we need to introduce the Zener-Hollomon parameter. The initial yield stress (σ_0), the saturation or peak stress (σ_s), the steady state stress (σ_{ss}), and the saturation strain (ϵ_s) which describe the stress-strain curve in the work hardening and dynamic softening regime (see [Figure M305-1](#)) can depend on the deformation temperature and strain rate. The Zener-Hollomon provides this dependence. The parameter is given by

$$Z = \max(\dot{\epsilon}, \dot{\epsilon}_{\min}) \exp\left(\frac{Q_{\text{def}}}{RT}\right) .$$

The stresses then have the general form of:

$$\sigma_i = a_i \ln Z + b_i, \quad i = 0, s, ss,$$

and the saturation strain, similarly, is given by

$$\varepsilon_s = a_{\varepsilon_s} \ln Z + b_{\varepsilon_s}.$$

In the above, $\dot{\varepsilon}$ is the effective strain rate, and $\dot{\varepsilon}_{\min}$ is the minimum strain rate for which the parameter fit is done to prevent unphysical values of σ_i and ε_s . If $VP = 1$ the effective *plastic* strain rates are used here. Q_{def} is the activation energy, R is the gas constant, and T is the temperature.

The work hardening model is based on the interplay between storage and annihilation of dislocations described by the Estrin and Mecking model

$$\sigma_{\text{EM}} = \sqrt{\sigma_s^2 - (\sigma_s^2 - \sigma_0^2) \exp(-2B_y \varepsilon_p)},$$

where B_y is a material parameter and ε_p is the effective plastic strain.

We include the effect of softening due to dynamic recrystallization in the prediction of the flow stress beyond a saturation strain, ε_s . To model this effect, we introduce the dynamic recrystallization fraction

$$X_{\text{drx}} = \begin{cases} 0, & \varepsilon_p < \varepsilon_s \\ 1 - \exp(-a(\varepsilon_p - \varepsilon_s)^b), & \varepsilon_p \geq \varepsilon_s \end{cases}$$

The transient flow stress due to work hardening and dynamic softening is, then, predicted using a mixture law between the steady state stress, σ_{ss} , and the Estrin Mecking stress, σ_{EM} :

$$\sigma = \sigma_{\text{EM}} - X_{\text{drx}}(\sigma_s - \sigma_{ss}).$$

The resulting hardening function then becomes

$$h = (1 - X_{\text{drx}})\sigma_{\text{EM}} + X_{\text{drx}}\sigma_{ss}.$$

Static Recovery and Static Recrystallization

After deformation, the material softens due to static recovery and static recrystallization. The static recovery stress, σ_{srx} , is modeled by

$$\sigma_{\text{srx}} = \sigma_0 + \Delta\sigma$$

where σ_0 is the initial yield stress and $\Delta\sigma$ is the change in stress due to dislocation climb. $\Delta\sigma$ changes with time by

$$\frac{d\Delta\sigma}{dt} = -\frac{64\Delta\sigma^2}{9M^3\alpha^2E(T)}\nu_D \exp\left(-\frac{U_0}{RT}\right) \sinh\left(\frac{\Delta\sigma\nu b_\nu^3}{kT}\right).$$

At the start of recovery $\Delta\sigma = \sigma_{\text{VM}} - \sigma_0$. M , α , ν_D , and b_ν are physical constants related to the properties of the FCC iron lattice, U_0 is the activation energy for climb, ν is the

interaction volume, and R and k are the universal gas constant and Boltzmann constant, respectively.

Static recovery starts when the material is under plastic load and the plastic strain rate is lower than THRES. It stops when the plastic strain rate is higher than THRES.

Softening is assumed to be caused by recrystallized grain growth. Deformed structure with high dislocation density is replaced with new grains with a low dislocation density and constant stress σ_0 . The recrystallized fraction is described by the static recrystallization fraction X_{srx} which is described via a standard JMAK expression

$$X_{\text{srx}} = 1 - \exp\left(-0.693 \left(\frac{t - t_{\text{start}}}{t_{50}}\right)^n\right),$$

where t is the total time, t_{start} is the start time of the recovery and t_{50} is the time required to reach 50% recrystallization.

Finally, the combined recovery stress state is expressed by a law of mixtures

$$\sigma_r = X_{\text{srx}}\sigma_0 + (1 - X_{\text{srx}})\sigma_{\text{srx}}.$$

If $A_{50} \neq 0$, the recrystallization time t_{50} may be calculated from

$$t_{50} = |A_{50}|(\varepsilon_p^{\text{tstart}})^p \left(\varepsilon_p^{\text{tstart}} \exp\left(\frac{Q_{\text{def}}}{RT}\right)\right)^q d^{G_{\text{sf}}} \exp\left(\frac{Q_{\text{rex}}}{RT}\right),$$

where $\varepsilon_p^{\text{tstart}}$ is the plastic strain at start of recovery. For $A_{50} > 0$, the parameter T50 is ignored, and the material routine calculates t_{50} with the above expression. For $A_{50} < 0$, the material routine uses the parameter T50, but, if POST = 1, LS-DYNA additionally calculates history variables $X_{\text{srx}}^{\text{post}}$ and σ_r^{post} with t_{50} from the expression above.

During static recovery, stress and effective plastic strain is annealed, meaning stress and back stress is scaled with

$$\gamma = \frac{\sigma_r - \sigma_0}{\sigma_{\text{VM}} - \sigma_0}, \quad 0 \leq \gamma \leq 1,$$

and the annealed plastic strain solves

$$\sigma_y(\varepsilon_p^{\text{annealed}}) = \gamma\sigma_y(\varepsilon_p).$$

History variables:

The following history variables are available by default:

History Variable #	Description
1-6	Back stress

History Variable #	Description
7	Temperature
8	Plastic strain rate
9	Plastic strain at start of recovery
10	Time since start of recovery ($t - t_{\text{start}}$). It is set to -1 when inactive.
11	Static recovery stress, σ_{srx}
12	Combined recovery stress, σ_r

The following additional variables are available if POST = 1:

History Variable #	Description
13	Initial yield stress, σ_0
14	Saturation stress, σ_s
15	Steady state stress, σ_{ss}
16	Saturation strain, ε_s
17	Dynamic recrystallization fraction, X_{drx}
18	Yield stress, σ_y
19	Static recrystallization fraction, X_{srx}

The following additional variables are available if POST = 1 and A50 < 0:

History Variable #	Description
20	Derived static recrystallization fraction, $X_{\text{srx}}^{\text{post}}$
21	Derived combined recovery stress, σ_r^{post}

References:

Schill, M., Karlsson, J., Magnusson, H., Huyan, F., Nosar, N.S., Lagergren, J., Narström, T., and Johansson, F. "Simulation of Hot Plate Rolling using LS-DYNA," *13th European LS-DYNA Conference* (2021).

***MAT_GENERALIZED_ADHESIVE_CURING**

This is Material Type 307. It incorporates a modular approach for modeling adhesive materials during chemical curing. This material model provides a general viscoelastic Maxwell model defined by its Prony series expansion with up to 18 terms that considers effects of temperature and degree of cure. It is supported for solid and cohesive solid elements.

Card Summary:

Card 1. This card is required.

MID	RO	GASC	IDOC	INCR	QCURE		
-----	----	------	------	------	-------	--	--

Card 2. This card is required.

CKOPT	CK1	CK2	CK3	CK4	CK5	CK6	CK7
-------	-----	-----	-----	-----	-----	-----	-----

Card 3. This card is required.

CEOPT	CE1	CE2	CE3	CE4			
-------	-----	-----	-----	-----	--	--	--

Card 4. This card is required.

TEOPT	TE1	TE2					
-------	-----	-----	--	--	--	--	--

Card 5. This card is required.

THOPT	TH1	TH2	TH3	TH4			
-------	-----	-----	-----	-----	--	--	--

Card 6. This card is required.

TVOPT	TV1	TV2					
-------	-----	-----	--	--	--	--	--

Card 7. This card is required.

PHOPT	PH1	PH2	PH3	PH4	PH5	PH6	
-------	-----	-----	-----	-----	-----	-----	--

Card 8. This card is required.

PVOPT	PV1	PV2	PV3	PV4			
-------	-----	-----	-----	-----	--	--	--

Card 9. This card is required.

PL10OPT	PL11	PL12	PL13	PL14	PL15		
---------	------	------	------	------	------	--	--

Card 10. This card is required.

PL20PT	PL21	PL22	PL23	PL24	PL25	PL26	
--------	------	------	------	------	------	------	--

Card 11. This card is required.

DAOPT	DAEVO	DATRIA	DA1	DA2	DA3	DA4	DA5
-------	-------	--------	-----	-----	-----	-----	-----

Card 12. This card is required.

DA6	DA7	DA8	DA9	DA10	DA11	PDA1	PDA2
-----	-----	-----	-----	------	------	------	------

Card 13. Up to 18 instantiations of this card may be input. A keyword ("*") card terminates this input if fewer than 18 cards are used. The number of terms for the shear behavior may differ from that for the bulk behavior: simply insert zero if a term is not included.

G_i	BETAG $_i$	K_i	BETAK $_i$				
-------	------------	-------	------------	--	--	--	--

Data Card Definitions:

Card 1	1	2	3	4	5	6	7	8
Variable	MID	RO	GASC	IDOC	INCR	QCURE		
Type	A	F	F	F	F	F		

VARIABLE

DESCRIPTION

MID	Material identification. A unique number or label must be specified (see *PART).
RO	Mass density
GASC	Gas constant, R
IDOC	Initial degree of cure, p_I
INCR	Switch between incremental and total stress formulation: EQ.1: Incremental form (default, recommended) EQ.2: Total form

VARIABLE**DESCRIPTION**

QCURE

Heat generation factor, relating the heat generated in one time step with the increment of the degree of cure in that step

Card 2	1	2	3	4	5	6	7	8
Variable	CKOPT	CK1	CK2	CK3	CK4	CK5	CK6	CK7
Type	I	F	F	F	F	F	F	F

VARIABLE**DESCRIPTION**

CKOPT

Curing kinetics option (see [Remark 1](#) for details):

EQ.0: No curing kinetics

EQ.1: Generalized model, with load curves for pre-exponential factors

EQ.2: Extended Kamal model

EQ.3: Kamal model

CK_{*i*}

*i*th curing kinetics model parameter. The meaning of the parameter depends on the choice of CKOPT. For details, see [Remark 1](#).

Card 3	1	2	3	4	5	6	7	8
Variable	CEOPT	CE1	CE2	CE3	CE4			
Type	I	F	F	F	F			

VARIABLE**DESCRIPTION**

CEOPT

Chemical expansion option (see [Remark 2](#) for details):

EQ.0: No chemical expansion

EQ.1: Differential form with load curve input

EQ.2: Secant form with load curve input

EQ.3: Secant form with polynomial expression

VARIABLE**DESCRIPTION**CE_i

i^{th} chemical expansion model parameter. The meaning of the parameter depends on the choice of CEOPT. For details, see [Remark 2](#).

Card 4	1	2	3	4	5	6	7	8
Variable	TEOPT	TE1	TE2					
Type	I	F	F					

VARIABLE**DESCRIPTION**

TEOPT

Thermal expansion option (see [Remark 3](#)):

EQ.0: No thermal expansion

EQ.1: Differential form with load curve input

EQ.2: Secant form with load curve input

TE_i

i^{th} thermal expansion parameter. The meaning of the parameter depends on the choice of TEOPT. For details, see [Remark 3](#).

Card 5	1	2	3	4	5	6	7	8
Variable	THOPT	TH1	TH2	TH3	TH4			
Type	I	F	F	F	F	F	F	

VARIABLE**DESCRIPTION**

THOPT

Option for horizontal temperature shift of the viscoelastic master curve as given by the Prony series expansion (see [Remarks 4](#) and [5](#)):

EQ.0: No temperature shift

EQ.1: Williams-Landel-Ferry (WLF) shift function

EQ.2: Arrhenius shift function

EQ.3: Combined WLF (above glass transition temperature T_g) and Arrhenius (below T_g) shift function

VARIABLE	DESCRIPTION							
	EQ.4: As 3, but with glass transition temperature $T_g(p)$ as function of degree of cure p							
	EQ.5: Direct input of shift factors as function of temperature							
TH <i>i</i>	i^{th} shifting parameter. The meaning of the parameter depends on the choice of THOPT. For details, see Remark 5 .							

Card 6	1	2	3	4	5	6	7	8
Variable	TVOPT	TV1	TV2					
Type	I	F	F					

VARIABLE	DESCRIPTION							
TVOPT	Option for vertical temperature shift of the master viscoelastic curve as given by the Prony series expansion. See Remarks 4 and 6 for details. EQ.0: No temperature shift EQ.1: Shifting of the complete master curves $G(t)$ EQ.2: Shifting of all terms G_i and K_i , but not G_∞ and K_∞							
TV <i>i</i>	The meaning of the shifting parameters depends on the choice of TVOPT. For details, see Remark 6 .							

Card 7	1	2	3	4	5	6	7	8
Variable	PHOPT	PH1	PH2	PH3	PH4	PH5	PH6	
Type	I	F	F	F	F	F	F	

VARIABLE	DESCRIPTION							
PHOPT	Option for horizontal shift due to curing effects of the master viscoelastic curve as given by the Prony series expansion (see Remarks 4 and 7): EQ.0: No shift							

VARIABLE	DESCRIPTION							
	EQ.1: Eom model							
	EQ.2: Direct input of shift factors as function of degree of cure							
PH <i>i</i>	<i>i</i> th shifting parameter. The meaning of the parameter depends on the choice of PHOPT. For details, see Remark 7 .							

Card 8	1	2	3	4	5	6	7	8
Variable	PVOPT	PV1	PV2	PV3	PV4			
Type	I	F	F	F	F			

VARIABLE	DESCRIPTION							
PVOPT	Option for vertical shift of the master viscoelastic curve due to curing effects as given by the Prony series expansion (see Remarks 4 and 8 for details):							
	EQ.0: No shift							
	EQ.1: Input of instantaneous moduli G_0 and K_0 as a function of degree of cure p . Assumption of constant ratios $G_i(p)/G_0(p)$ and $K_i(p)/K_0(p)$.							
	EQ.2: Input of long-term moduli $G_\infty(p)$ and $K_\infty(p)$ as functions of degree of cure p and of scaling functions for other moduli G_i and K_i .							
PV <i>i</i>	<i>i</i> th shifting parameter. The meaning of the parameter depends on the choice of PVOPT. For details, see Remark 8 .							

Card 9	1	2	3	4	5	6	7	8
Variable	PL1OPT	PL11	PL12	PL13	PL14	PL15		
Type	I	F	F	F	F	F		

VARIABLE	DESCRIPTION							
PL1OPT	Option for yield function description (see Remarks 9 and 10):							
	EQ.0: No plasticity							

VARIABLE	DESCRIPTION
	EQ.1: Version of Toughened Adhesive Polymer model (TAPO) with cap in tension and Drucker & Prager in compression with distortional hardening under plastic flow
	EQ.2: Version of Toughened Adhesive Polymer model (TAPO) with cap in tension and von Mises in compression
	EQ.3: Version of Toughened Adhesive Polymer model (TAPO) with cap in tension and Drucker & Prager in compression with distortional hardening under temperature change.

PL1*i* *i*th yield surface parameter. The meaning of the parameter depends on the choice of PL1OPT. For details, see [Remark 10](#).

Card 10	1	2	3	4	5	6	7	8
Variable	PL20PT	PL21	PL22	PL23	PL24	PL25	PL26	PL27
Type	I	F	F	F	F	F	F	F

VARIABLE	DESCRIPTION
PL2OPT	<p>Option for yield stress description (see Remarks 9 and 11 for details):</p> <p>EQ.0: No plasticity</p> <p>EQ.1: Tabular input for yield stress as function of curing, temperature, and plastic strains.</p> <p>EQ.2: Tabular input for initial yield stress as function of curing and temperature and for hardening as function of curing, temperature, and plastic strains.</p> <p>EQ.3: Load curve inputs for effects of curing on initial yield stress and on hardening. Load curve input for temperature dependence of initial yield stress. Tabular input for hardening as function of temperature and strain</p> <p>EQ.4: Load curve inputs for effects of curing and temperature on the parameters for the yield stress definitions in the Toughened Adhesive Polymer model (TAPO)</p> <p>EQ.5: Yield stress definitions in the Toughened Adhesive Polymer model (TAPO). No influence of temperature or curing.</p>

VARIABLE	DESCRIPTION
----------	-------------

PL2*i* *i*th yield stress parameter. The meaning of the parameter depends on the choice of PL2OPT. For details, see [Remark 11](#).

Card 11	1	2	3	4	5	6	7	8
Variable	DAOPT	DAEVO	DATRIA	DA1	DA2	DA3	DA4	DA5
Type	I	I	I	F	F	F	F	F

VARIABLE	DESCRIPTION
----------	-------------

DAOPT Material damaging option (damage parameter D_1), defines the strain thresholds γ_c and γ_f for damage initiation and rupture (see [Remark 12](#)):

EQ.0: No material damage

EQ.1: Version of Toughened Adhesive Polymer model (TAPO): Strain threshold exponential function of triaxiality. Load curve inputs for temperature and cure dependence.

EQ.2: Version of Toughened Adhesive Polymer model (TAPO). Same as 1, but without temperature and cure dependence.

EQ.3: Version of Toughened Adhesive Polymer model (TAPO). Same as 1, but with additional strain rate dependency.

DAEVO Effective strain measure used for material damage evolution (see [Remark 12](#)):

EQ.0: Arc length of damage plastic strain

EQ.1: Arc length of plastic strain

EQ.2: Arc length of viscoelastic-plastic strain rate

DATRIAX Triaxiality flag for calculation of strain thresholds γ_c and γ_f for damage initiation and rupture of material damage option (see [Remark 12](#)):

EQ.0: Use triaxiality factor only in tension

EQ.1: Use triaxiality factor in tension and compression

VARIABLE	DESCRIPTION
----------	-------------

DA_i	i^{th} material damage parameter. The meaning of the parameter depends on the choice of DAOPT for the evolution of damage parameter D_1 . For details, see Remark 12 .
--------	---

Card 12	1	2	3	4	5	6	7	8
Variable	DA6	DA7	DA8	DA9	DA10	DA11	PDA1	PDA2
Type	F	F	F	F	F	F	F	F

VARIABLE	DESCRIPTION
----------	-------------

DA_i	i^{th} material damage parameter. The meaning of the parameter depends on the choice of DAOPT for the evolution of damage parameter D_1 . For details, see Remark 12 .
--------	---

PDA1	Parameter for the (pre-) damage formulation due to for example viscous fingering. It defines the damage parameter D_2 as function of the thickness strain ϵ_{33} and the degree of cure p . For details, see Remark 13 .
------	---

- EQ.0: No damage
- GT.0: Use exponential approach
- LT.0: Load curve input with ID |PDA1| input for $D_2(\epsilon_{33})$

PDA2	Gelation point p_{gel} as needed for calculation of damage parameter D_2 . For details, see Remark 13 .
------	--

Viscoelastic Constant Cards. Up to 18 cards may be input. A keyword (“*”) card terminates this input if fewer than 18 cards are used. The number of terms for the shear behavior may differ from that for the bulk behavior: simply insert zero if a term is not included. See [Remark 4](#).

Card 13	1	2	3	4	5	6	7	8
Variable	G_i	BETAG i	K_i	BETAK i				
Type	F	F	F	F				

VARIABLE	DESCRIPTION
G_i	Shear relaxation modulus for the i^{th} term
BETAG i	Shear decay constant for the i^{th} term
K_i	Bulk relaxation modulus for the i^{th} term
BETAK i	Bulk decay constant for the i^{th} term

Remarks:

- Curing Kinetics.** Within this material formulation an internal variable p has been included to represent the degree of cure for the adhesive. The evolution equation for this variable in the most general form that is used here reads

$$\frac{dp}{dt} = K_1(T) \times (1 - p)^{n_1} + K_2(T) \times p^m \times (1 - p)^{n_2} .$$

For CKOPT = 1, the functions $K_1(T)$ and $K_2(T)$ can be defined as load curves. For the other options CKOPT = 2 and 3, analytical equations for those functions are assumed:

$$K_i(T) = k_i \exp\left(-\frac{Q_i}{RT}\right) .$$

In the above, R is the universal gas constant. Its value is set with GASC in Card 1. The standard Kamal model (CKOPT = 3) introduces a simplification to the above equations with $n_1 = n_2 = n$.

The input structure is summarized in the following table:

CKOPT	CK1	CK2	CK3	CK4	CK5	CK6	CK7
1	$K_1(T)$	$K_2(T)$	m	n_1	n_2		
2	k_1	k_2	Q_1	Q_2	m	n_1	n_2
3	k_1	k_2	Q_1	Q_2	m	n	

- Chemical Shrinkage.** The chemical reaction of the curing process results in shrinkage of the material. Three options are available to model this behavior.

For CEOPT = 1 and 2, the coefficient of chemical shrinkage, $\gamma(p)$, is specified with a load curve. For CEOPT = 3, the coefficient is given by the following quadratic expression:

$$\gamma(p) = \gamma_2 p^2 + \gamma_1 p + \gamma_0 .$$

For CEOPT = 1, this load curve is used to compute the chemical strains by the following differential form:

$$d\epsilon^{ch} = \gamma(p)dp.$$

CEOPT = 2 and 3 invoke a secant form, such that the strains are computed as:

$$\epsilon^{ch} = \gamma(p) \times (p - p_R) - \gamma(p_I) \times (p_I - p_R),$$

with a reference degree of cure p_R and initial degree of cure p_I .

The following table summarizes the input structure.

CEOPT	CE1	CE2	CE3	CE4
1	$\gamma(p)$			
2	$\gamma(p)$	p_R		
3	γ_0	γ_1	γ_2	p_R

- Thermal Expansion.** Like the strains resulting from chemical shrinkage discussed in Remark 2, the thermal strains are either defined in a secant or differential form. In both cases the coefficient of thermal expansion $\eta(p, T)$ can be given as function of degree of cure p and temperature T and requires the input by of two-dimensional tabular data.

Option TEOPT = 1 refers to the differential form

$$d\epsilon^{th} = \eta(p, T) dT .$$

TEOPT = 2 invokes the secant formulation which requires the specification of an additional reference temperature T_R

$$\epsilon^{th} = \eta(p, T) \times (T - T_R) - \eta(p, T_I) \times (T_I - T_R) .$$

Coefficient $\eta(p, T)$ is specified with a 2D table (*DEFINE_TABLE_2D) whose ID is provided by parameter TE1. The values given in the table input correspond to the degree of cure and the abscissa of the referenced curve to temperature. If a load curve is reference by parameter TE1, the coefficient η is assumed to be a function of temperature.

The following table summarizes the input structure.

TEOPT	TE1	TE2
1	$\eta(p, T)$	

TEOPT	TE1	TE2
2	$\eta(p, T)$	T_R

4. **Stress Relaxation.** The Cauchy stress, σ_{ij} , is related to the strain rate by:

$$\sigma_{ij}(t) = \int_0^t g_{ijkl}(t - \tau) \frac{\partial \varepsilon_{kl}(\tau)}{\partial \tau} d\tau .$$

The relaxation functions $g_{ijkl}(t - \tau)$ are represented in this material formulation by up to 18 terms of the Prony series for the shear modulus G and the bulk modulus K as functions of time t . For the shear modulus G , the series expansion is given by:

$$G(t) = G_\infty + \sum_i G_i e^{-\beta_i^G t} = G_0 - \sum_i G_i + \sum_i G_i e^{-\beta_i^G t},$$

with shear relaxation moduli G_i and decay constants β_i^G . The relation between the shear equilibrium modulus G_∞ and the instantaneous shear modulus G_0 are given by

$$G_\infty = G_0 - \sum_i G_i.$$

A similar Prony series definition is expected for the bulk modulus $K(t)$.

In most applications the viscoelastic properties depend on temperature and degree of cure. In this material, these dependencies are realized with shifting functions acting on the moduli G_i , G_0 and G_∞ (vertical shifting) and on the decay constants β_i (horizontal shifting). Note that if not stated otherwise the same shifting operations are used for shear and bulk moduli. The shifting functions are defined by Cards 5 to 8 and discussed in [Remarks 5, 6, 7 and 8](#).

5. **Horizontal Temperature Shift.** You can account for a possible temperature effect on the stress relaxation (see [Remark 4](#)) by a horizontal shift operation on the relaxation curve, implemented by the scaling of the decay constants β_i with a factor $a_T(T)$.

For THOPT = 1, the Williams-Landel-Ferry (WLF) shift function is used:

$$\ln(a_T(T)) = \frac{-A(T - T_R)}{B + T - T_R}$$

with constant parameters A and B and the reference temperature T_R .

THOPT = 2 invokes the Arrhenius shift function which requires the input of a reference temperature T_R and one parameter C :

$$\ln(a_T(T)) = C \left(\frac{1}{T} - \frac{1}{T_R} \right)$$

For many adhesive materials, the qualitative behavior of the temperature dependence changes with the glass transition temperature T_G from an Arrhenius- to a WLF-type description of the shifting. THOPT = 3 provides this behavior:

$$\ln(a_T(T)) = \begin{cases} C \left(\frac{1}{T} - \frac{1}{T_G} \right) & T \leq T_G \\ \frac{-A(T - T_G)}{B + T - T_G} & T > T_G \end{cases}$$

It has been proposed in literature to extend this option by a curing that depends on the glass transition temperature $T_G = T_G(p)$, such that the shifting factor reads

$$\ln(a_T(T, p)) = \begin{cases} C \left(\frac{1}{T} - \frac{1}{T_G(p)} \right) & T \leq T_G(p) \\ \frac{-A(T - T_G(p))}{B + T - T_G(p)} & T > T_G(p) \end{cases}$$

This feature corresponds to THOPT = 4. The glass transition temperature must be input as a load curve.

For the options discussed so far, no difference in temperature dependence is made between the shear and bulk moduli. The same scaling is applied to both Prony series expansions.

Finally, THOPT = 5 allows defining direct input for scaling factors a_T^G and a_T^K for the shear and bulk moduli, respectively. Load curve or table IDs are expected as input. The load curves (either referenced by the table or by the input) define the logarithm of the factors, that is, $\ln(a_T^G)$ and $\ln(a_T^K)$, as functions of temperature. In case of a table ID input, an additional dependence on the degree of cure can be accounted for.

The parameters input for the different options are shown in the following table.

THOPT	TH1	TH2	TH3	TH4
1	A	B	T_R	
2	C	T_R		
3	A	B	C	T_G
4	A	B	C	$T_G(p)$
5	$\ln(a_T^G(T)) / \ln(a_T^G(p, T))$	$\ln(a_T^K(T)) / \ln(a_T^K(p, T))$		

6. **Vertical Temperature Shift.** To model the effect of temperature on the viscoelastic response, you can apply a vertical shift to the master relaxation curve (see [Remark 4](#)). The shear relaxation moduli (G_i and G_∞) and bulk relaxation moduli (K_i and K_∞) are scaled by temperature dependent scaling factors $b_T^G(T)$ and $b_T^K(T)$, respectively, to achieve this shift. The input parameters for the factors need to be load curves. Here, parameter TV1 refers to $b_T^G(T)$ and TV2 to $b_T^K(T)$.

For TVOPT = 1 the entire relaxation curve is scaled. In contrast, TVOPT = 2 causes shifting of only the time dependent terms of the Prony series and, consequently, only the moduli G_i and K_i are scaled.

7. **Horizontal p -Shift.** The effect of curing on the viscoelastic property of an adhesive material can be modelled by a horizontal shift of the relaxation curve (see [Remark 4](#)), meaning by scaling the decay moduli β_i . The scaling factors are denoted in this case by a_c .

For PHOPT = 1, an analytical expression based on Eom et al is implemented

$$\log(a_c(p)) = \begin{cases} c(p - p_{\text{gel}}) + a_{\text{gel}} & p < p_{\text{gel}} \\ a_{\text{gel}} H^{(p-p_{\text{gel}})} \left(\frac{p_f - p}{p_f - p_{\text{gel}}} \right)^m & p \geq p_{\text{gel}} \end{cases}$$

with p_{gel} and a_{gel} being properties at the gelation point of the material. This shift is applied to both the shear and bulk moduli.

PHOPT = 2 offers the possibility of a direct input of the scaling factors as functions of degree of cure. Here, load curves defining $\log(a_c^G)$ for shifting the shear curve and $\log(a_c^K)$ for shifting the bulk curve are expected.

The set of input parameters is summarized in the following table.

PHOPT	PH1	PH2	PH3	PH4	PH5	PH6
1	p_{gel}	a_{gel}	c	H	p_f	m
2	$\log(a_c^G(p))$	$\log(a_c^K(p))$				

8. **Vertical p -Shift.** We have implemented two different approaches to represent the effect of curing on the viscoelasticity through vertical shifting operations. The vertical shifting operations apply to the master curves $G(t)$ and $K(t)$ as defined in [Remark 4](#).

The first approach (PVOPT = 1) is taken from *MAT_277 and assumes a constant ratio $G_i(p)/G_0(p)$ for all degrees of cure. Consequently, it suffices to define one

term $G_0(p)$ as a function of the degree of cure and further coefficients for the fully cured state of the adhesive:

$$G(t, p) = G_0(p) \left(1 - \sum_i \frac{G_{i,p=1.0}}{G_{0,p=1.0}} (1 - e^{-\beta_i t}) \right).$$

PVOPT = 2 distinguishes the effect of curing on the equilibrium moduli from its effect on the time-depending terms of the Prony series. Consequently, load curve IDs are expected to define $G_\infty(p)$ and $K_\infty(p)$ as well as scaling factors $b_c^G(p)$ and $b_c^K(p)$. The latter are applied to all G_i and K_i , respectively. This is also reflected by the input structure shown in the following table.

PVOPT	PV1	PV2	PV3	PV4
1	$G_0(p)$	$K_0(p)$		
2	$G_\infty(p)$	$K_\infty(p)$	$b_c^G(p)$	$b_c^K(p)$

9. **Plasticity.** This material features an isotropic plasticity formulation with a non-associated flow rule closely related to the TAPO model implemented in *MAT_252. Both, the yield criterion F as well as the flow potential F^* , are defined in terms of invariants \tilde{I}_1 and \tilde{J}_2 of the effective stress tensor:

$$\tilde{\sigma} = \sigma / (1 - D_1)(1 - D_2),$$

where the evolution of the damage parameters D_1 and D_2 is defined separately.

The general form of F and F^* in this model is given by

$$\begin{aligned} F &= f(\tilde{I}_1, \tilde{J}_2, r, T) - \tau_Y^2(p, T, r) = 0 \\ F^* &= f^*(\tilde{I}_1, \tilde{J}_2) - \tau_Y^2(p, T, r) \end{aligned}$$

The yield surface f and yield strength τ_Y are functions of the arc length of the damage plastic strain rate \dot{r} , which is defined by means of the arc length of the plastic strain rate $\dot{\gamma}_v$ as in Lemaitre [1992]:

$$\dot{r} = (1 - D_1)\dot{\gamma}_v = (1 - D_1)\sqrt{2 \text{tr}(\dot{\epsilon}^P)^2}.$$

The plastic strain rate $\dot{\epsilon}^P$ is given by the non-associated flow rule

$$\dot{\epsilon}^P = \lambda \frac{\partial F^*}{\partial \sigma}.$$

The expressions for f and f^* or in other words the form of yield surface and flow potential are determined by the choice of parameters in Card 9. The yield strength computation is defined by Card 10. For details, see [Remarks 10](#), [11](#), [12](#), and [13](#).

10. **Yield Surface.** The yield surface definition is controlled by choice of parameter PL1OPT in Card 9. For the currently available options PL1OPT = 1, 2 or 3, the same flow potential is assumed:

$$f^*(\tilde{I}_1, \tilde{J}_2) = \tilde{J}_2 + \frac{a_2^*}{3} \langle \tilde{I}_1 \rangle^2 ,$$

where a_2^* is a user-defined material parameter.

Choosing PL1OPT = 1 results in a cap model in tension and nonlinear Drucker & Prager in compression with a distortional hardening under plastic flow. There is no temperature dependence for function f in this case, which reads:

$$f(\tilde{I}_1, \tilde{J}_2, r) = \tilde{J}_2 + \frac{1}{\sqrt{3}} a_1(r) \tau_0 \tilde{I}_1 + \frac{a_2(r)}{3} \langle \tilde{I}_1 \rangle^2 .$$

Distortional hardening is introduced by phenomenological descriptions for parameters $a_1(r)$ and $a_2(r)$:

$$\begin{aligned} a_1(r) &= a_{10} + a_1^H r \\ a_2(r) &= \max(a_{20} + a_2^H r, 0.0) \end{aligned}$$

PL1OPT = 2 does not consider distortional hardening and refers to a cap model in tension and a von Mises yield function in compression:

$$f(\tilde{I}_1, \tilde{J}_2) = \tilde{J}_2 + \frac{a_{20}}{3} \left\langle \tilde{I}_1 + \frac{\sqrt{3} a_{10} \tau_0}{2 a_{20}} \right\rangle^2 - \frac{a_{10}^2 \tau_0^2}{4 a_{20}} .$$

Finally, PL1OPT = 3 refers to a temperature dependent yield surface. Equivalently to PL1OPT = 1 a cap model in tension and nonlinear Drucker & Prager in compression is used, but the distortional hardening is defined with respect to the current temperature:

$$f(\tilde{I}_1, \tilde{J}_2, T) = \tilde{J}_2 + \frac{1}{\sqrt{3}} a_{10} \tau_0 \tilde{I}_1 + \frac{a_2(T)}{3} \langle \tilde{I}_1 \rangle^2 ,$$

with the simple linear temperature dependence

$$a_2(T) = a_{20} (1 - m_{a2} (T - T_0)) .$$

Input parameters for the different options can be found in the following table:

PL1OPT	PL11	PL12	PL13	PL14	PL15
1	a_{10}	a_{20}	a_2^*	a_1^H	a_2^H
2	a_{10}	a_{20}	a_2^*		
3	a_{10}	a_{20}	a_2^*	m_{a2}	T_0

11. **Yield strength.** The yield strength τ_Y is defined by the parameters in Card 10. Different options are available to define temperature and degree of cure dependent hardening behavior. The most general option (PL2OPT = 1) is a three-dimensional tabular input for $\tau_Y(p, T, r)$, employing *DEFINE_TABLE_3D. Here p is the degree of cure, T is the temperature, and r is the damage plastic strain.

For PL2OPT = 2, initial strength τ_0 and hardening R are defined independently with tabular data. Their sum represents the current yield strength:

$$\tau_Y(p, T, r) = \tau_0(p, T) + R(p, T, r).$$

A two-dimensional table (*DEFINE_TABLE_2D) is required to define $\tau_0(p, T)$ as a function of degree of cure p and temperature T . The hardening part $R(p, T, r)$ naturally requires a three-dimensional table (*DEFINE_TABLE_3D).

PL2OPT = 3 employs the same split between initial and hardening part as the second option, but it is further assumed, that the effect of curing can be modelled by different scaling operations $\chi_c(p)$ and $\phi_c(p)$:

$$\tau_Y(p, T, r) = \tau_{0\theta}(T)\chi_c(p) + R_\theta(T, r)\phi_c(p).$$

The input only requires a two-dimensional tabular input for the hardening $R_\theta(T, r)$ and three load curve definitions (see *DEFINE_CURVE) for $\tau_{0\theta}(T)$, $\chi_c(p)$ and $\phi_c(p)$.

PL2OPT = 4 only differs from PL2OPT = 3 in the input of the temperature dependent hardening part $R_\theta(T, r)$. Instead of tabular data, an exponential hardening behavior is assumed. When PL2OPT = 4 is invoked, the following analytical expression for $R_\theta(T, r)$ is used:

$$R_\theta(T, r) = H_\theta(T)r + q_\theta(T)(1 - e^{-b_\theta(T)r}) .$$

Temperature dependencies for the parameters H_θ , q_θ , and b_θ requires load curve input.

The simplest version is invoked by PL2OPT = 5, where the yield strength $\tau_Y(r)$ is a function solely of the plastic strain data. Again, an exponential hardening is assumed:

$$\tau_Y(r) = \tau_0 + Hr + q(1 - e^{-br}).$$

The input of the parameters is shown in the following table.

PL2OPT	PL21	PL22	PL23	PL24	PL25	PL26
1	$\tau_Y(p, T, r)$					
2	$\tau_0(p, T)$	$R(p, T, r)$	a_2^*			

PL2OPT	PL21	PL22	PL23	PL24	PL25	PL26
3	$\tau_{0\theta}(T)$	$\chi_c(p)$	$R_\theta(T, r)$	$\phi_c(p)$		
4	$\tau_{0\theta}(T)$	$\chi_c(p)$	$q_\theta(T)$	$b_\theta(T)$	$H_\theta(T)$	$\phi_c(p)$
5	τ_0	q	B	H		

12. **Material Damage.** Material damage is defined in terms of the damage parameter D_1 . Its evolution is based on the approach in Lemaitre [1985]. The general formulation can be defined in terms of a chosen strain measure ζ as follows:

$$\dot{D}_1 = \dot{D}_1(\zeta, \dot{\zeta}) = n \left\langle \frac{\zeta - \gamma^c}{\gamma^f - \gamma^c} \right\rangle^{n-1} \frac{\dot{\zeta}}{\gamma^f - \gamma^c}.$$

The parameter DAEVO defines the strain measure ζ . For DAEVO = 0, the arc length of the damage plastic strain rate is used: $\dot{\zeta} = \dot{r}$. The arc length of plastic strain rate $\dot{\gamma}_v$ governs the damage evolution for DAEVO = 1, that is, $\dot{\zeta} = \dot{\gamma}_v$. DAEVO = 2 employs the viscoelastic-plastic strain rate $\dot{\gamma}$ as strain rate measure:

$$\dot{\zeta} = \dot{\gamma} = \sqrt{2\text{tr}((\dot{\epsilon}^{\text{VP}})^2)}, \quad \dot{\epsilon}^{\text{VP}} = \dot{\epsilon} - \dot{\epsilon}^{\text{th}} - \dot{\epsilon}^{\text{ch}}.$$

The strains at the thresholds γ_c and γ_f for damage initiation and rupture depend on a function $\zeta(\eta)$ of the triaxiality η . This function $\zeta(\eta)$ determines if triaxiality is considered only under tensile loading or under tensile and compressive loading. Consequently, there are two choices available: For DATRIAX = 0, the Maccauley bracket is used ($\zeta(\eta) = \langle \eta \rangle$), whereas DATRIAX = 1 reduces ζ to the identity ($\zeta(\eta) = \eta$).

The particular equations for the strain thresholds γ_c and γ_f are determined by the damage option parameter DAOPT. Choosing DAOPT = 1 allows for temperature and degree of cure dependence:

$$\begin{aligned} \gamma^c &= \left(d_1^c + d_2^c(e^{-d_3\zeta(\eta)}) \right) d_\theta(T)\beta(p) \\ \gamma^f &= \left(d_1 + d_2(e^{-d_3\zeta(\eta)}) \right) d_\theta(T)\delta(p) \end{aligned}$$

Functions $d_\theta(T)$, $\beta(p)$, and $\delta(p)$ each require a load curve input. These functions are omitted in the simplified option DAOPT = 2, for which the strain thresholds reduce to

$$\begin{aligned} \gamma^c &= \left(d_1^c + d_2^c(e^{-d_3\zeta(\eta)}) \right) \\ \gamma^f &= \left(d_1 + d_2(e^{-d_3\zeta(\eta)}) \right) \end{aligned}$$

Strain rate effects for the definition of the thresholds are incorporated into option DAOPT = 3 following Johnson and Cook [1985], which leads to

$$\gamma^c = \left(d_1^c + d_2^c(e^{-d_3 \xi(\eta)}) \right) d_\theta(T) \beta(p) \left(1 + d_4 \left\langle \ln \dot{\gamma} / \dot{\gamma}_0 \right\rangle \right)$$

$$\gamma^f = \left(d_1 + d_2(e^{-d_3 \xi(\eta)}) \right) d_\theta(T) \delta(p) \left(1 + d_4 \left\langle \ln \dot{\gamma} / \dot{\gamma}_0 \right\rangle \right)$$

The parameter input is summarized in the following table:

DAOPT	DA1	DA2	DA3	DA4	DA5	DA6
1	n	d_1^c	d_2^c	d_1	d_2	d_3
2	n	d_1^c	d_2^c	d_1	d_2	d_3
3	n	d_1^c	d_2^c	d_1	d_2	d_3
DAOPT	DA7	DA8	DA9	DA10	DA11	
1	$d_\theta(T)$	$\beta(p)$	$\delta(p)$			
2						
3	$d_\theta(T)$	$\beta(p)$	$\delta(p)$	d_4	$\dot{\gamma}_0$	

13. **Viscous Fingering.** Viscous fingering can occur if the connected partners (partially) separate while the connecting adhesive is still in the liquid phase, resulting in an incomplete bonding of the partners. For this material model we implemented a rather simple phenomenological approach. An additional damage parameter D_2 models the effect of viscous fingering. D_2 accounts for the reduction of the effective adhesive area. Furthermore, we assume that D_2 can be expressed as function $\delta_A(\epsilon_{33})$ of the thickness strain ϵ_{33} of the element.

In the liquid phase $p < p_{gel}$, this damage mechanism is active if parameter PDA1 is nonzero. For positive values of PDA1, the parameter is interpreted as scalar input β_A for an exponential approach:

$$D_2 = \delta_A(\epsilon_{33}) = 1 - \exp(-\beta_A \epsilon_{33})$$

Alternatively, a negative input for PDA1 implies a direct input of $D_2 = \delta_A(\epsilon_{33})$ as a load curve with ID = |PDA1|.

As soon as the degree of cure exceeds the gelation point p_{gel} , the mechanism is stopped and the damage parameter D_2 remains constant. The value for p_{gel} is to be given as input parameter PDA2.

14. **Histories Variables.** The most important history variables are listed in the following table:

History Variable #	Description
1	Temperature, T
2	Degree of cure, p
3	Chemical expansion
4	Thermal expansion
5	Initial temperature, T_0
6	Material damage parameter, D_1
7	Viscous fingering damage parameter, D_2
8	Effective strain measure, ζ , for material damage
10	Current effective shear modulus, $G(t)$
11	Current effective bulk modulus, $K(t)$

***MAT_IFPD**

This is Material Type 319. It is for modeling fluid particles for incompressible free surface flow with incompressible SPG. It was developed to predict the shape evolution of solder joints during the electronic reflow process. See Pan et al 2020 for details.

WARNING: The *MAT_319 keyword name cannot be used in the input deck in R13. For R13, you must use *MAT_IFPD as the keyword name. For releases after September 2021, *MAT_319 can be used in the input deck.

Card 1	1	2	3	4	5	6	7	8
Variable	MID	RO	DYNVIS	SFTEN				
Type	A	F	F	F				

VARIABLE**DESCRIPTION**

MID	Material identification. A unique number or label must be specified (see *PART).
RO	Fluid density
DYNVIS	Dynamic viscosity of the fluid
SFTEN	Surface tension coefficient of the fluid

References:

Pan, X., Wu, C.T., and Hu, W. "Incompressible Smoothed Particle Galerkin (ISPG) Method for an Efficient Simulation of Surface Tension and Wall Adhesion Effects in the 3D Reflow Soldering Process," *16th International LS-DYNA Users Conference* (2020).

***MAT_COHESIVE_GASKET**

This is Material Type 326 developed for analysis of gaskets. This material model can only be used with cohesive elements. Also, a gasket thickness must be set; see the variable ELFORM and GASKETT in *SECTION_SOLID.

Card 1	1	2	3	4	5	6	7	8
Variable	MID	RO	ROFLG	INTFAIL				
Type	A	F	F	I				

Card 2	1	2	3	4	5	6	7	8
Variable	LC	UC	ETEN					
Type	F	F	F					

Card 3	1	2	3	4	5	6	7	8
Variable	ETSR							
Type	F							

Card 4	1	2	3	4	5	6	7	8
Variable	EMEM	PR	PS					
Type	F	F	F					

VARIABLE

DESCRIPTION

- MID Material identification. A unique number or label be specified (see *PART).
- RO Mass density

VARIABLE	DESCRIPTION
ROFLG	Flag for whether density is specified per unit area or volume: EQ.0: Density is per unit volume (default). EQ.1: Density is per unit area for controlling the mass of cohesive elements with an initial volume of zero
INTFAIL	Quadrature rule. Note that this material has no failure LE.0: 2×2 Newton-Cotes quadrature GT.0: 2×2 Gaussian quadrature
LC	Main load curve ID defining the pressure as function of closure, $p = p(c)$
UC	Table ID defining the unloading curves
ETEN	Tensile stiffness
ETSR	Transverse shear stiffness
EMEM	Membrane stiffness
PR	Membrane Poisson ratio
PS	Membrane plane stress or plain strain assumption: EQ.0: Plane stress (default) EQ.1: Plane strain

Remarks:

- Cohesive Elements for Modeling Gaskets.** A gasket is a mechanical seal placed between two mating surfaces to prevent leakage. A gasket is typically thin in comparison to the length and width of its surface. This makes it cumbersome to model with solid elements, since these require good aspect ratios. Cohesive elements, however, are less sensitive to this kind of geometric quality and are, therefore, better suited for modeling gaskets. To use cohesive elements for modeling gaskets, the normal (the local 3-direction) of the cohesive element must be aligned with the gasket thickness direction, and the mid-surface of the cohesive element (the local 1-, and 2-direction) must coincide with the gasket surface.
- Material Model.** The strains pertaining to the normal are defined by: $\varepsilon_{13} = \delta_1$, $\varepsilon_{23} = \delta_2$, and $\varepsilon_{33} = \delta_3$. δ_i is the separation in local direction $i = 1,2,3$, meaning

the relative displacement between the top and bottom face of the cohesive element measured along local direction i . In particular, $-\varepsilon_{33}$ is the so-called gasket closure, c . The so-called membrane strains, ε_{11} , ε_{12} , and ε_{22} , in the plane orthogonal to the normal follow the usual definition $\varepsilon_{ij} = (\partial_j u_i + \partial_i u_j)/2$, where u_i , $i = 1, 2$, is the local displacement of the mid-surface.

The cohesive gasket material model is comprised of the following three uncoupled material models:

- a) Isotropic linear elastic membrane stress:

$$\begin{bmatrix} \sigma_{11} \\ \sigma_{22} \\ \sigma_{12} \end{bmatrix} = D \begin{bmatrix} \varepsilon_{11} \\ \varepsilon_{22} \\ 2\varepsilon_{12} \end{bmatrix}$$

with D as the constitutive matrix for either plane strain or stress.

- b) Isotropic linear elastic transverse stress:

$$\sigma_{i3} = E_{TSR} \delta_i, \quad i = 1, 2$$

- c) A user defined pressure-closure relation of the form (see [Remark 3](#)):

$$\begin{aligned} -\sigma_{33} &\equiv p = f(c), & c > 0 \\ \sigma_{33} &= 0, & \text{otherwise} \end{aligned}$$

3. **Pressure-Closure Relation.** The pressure-closure relation, f , is an important feature of the material model. It can be used to include mechanical effects that are typical for gaskets, such as hysteresis. It consists of a main loading curve and one or more unloading curves.

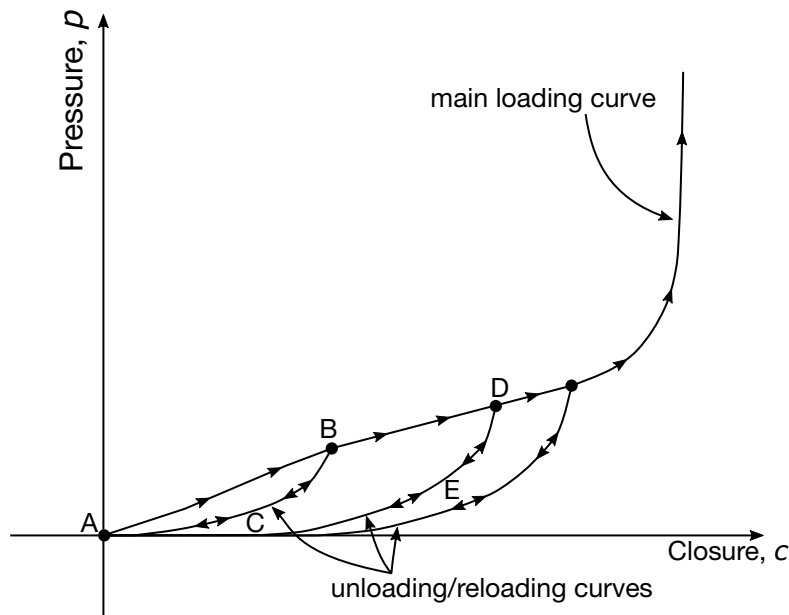

Figure M326-1. Schematic pressure-closure response

Figure M326-1 gives a schematic of a pressure-closure response. As the gasket is compressed the closure, c , increases and the pressure, p , follows the main loading curve from A to, say, B. Now, if the gasket for some reason is unloaded at B, c will then decrease and p follows the unloading curve BCA back to the initial configuration A. If the gasket is then reloaded it will follow the path ACB back to B. Then, when c exceeds the closure value at point B, it will continue on the main loading curve until some new point D, where unloading takes place. The new unloading then follows the path DEA back to A. If unloading occurs between two unloading curves, interpolation is used to determine the pressure.

Which unloading path to follow and where to switch to the main loading curve is determined by keeping track of the maximum value of c , called c_{max} , at the last unloading point. If the closure becomes negative, that is, the gasket is subject to tension rather than compression, its stiffness is given by E_{TEN} . This is mostly for numerical stability. The unloading curves must be input using *DEFINE_TABLE_2D, with the first dependency being maximum closure and the second closure, meaning $p = p(c_{max}, c)$. Also, the unloading curves should be in a normalized form giving zero pressure for zero closure and unit pressure for unit closure.

4. **History Variables.** This material model outputs the maximum closure as history variable #1 to the post-processing database. Therefore, NEIPH and NEIPS must be set in *DATABASE_EXTENT_BINARY.

***MAT_ALE_VACUUM**

***MAT_ALE_01**

***MAT_ALE_VACUUM**

See *MAT_VACUUM or *MAT_140.

***MAT_ALE_02**

***MAT_ALE_GAS_MIXTURE**

***MAT_ALE_GAS_MIXTURE**

See *MAT_GAS_MIXTURE or *MAT_148.

*MAT_ALE_VISCOUS

This may also be referred to as MAT_ALE_03. This “fluid-like” material model is very similar to Material Type 9 (*MAT_NULL). It allows the modeling of non-Newtonian fluids with constant or variable viscosity. The variable viscosity is a function of an equivalent deviatoric strain rate. If inviscid material is modeled, the deviatoric or viscous stresses are zero, and the equation of state supplies the pressures (or diagonal components of the stress tensor). All *MAT_ALE_ cards apply only to ALE elements.

Card 1	1	2	3	4	5	6	7	8
Variable	MID	RO	PC	MULO	MUHI	RK		RN
Type	A	F	F	F	F	F		F
Defaults	none	none	0.0	0.0	0.0	0.0		0.0

VARIABLE

DESCRIPTION

MID	Material identification. A unique number or label must be specified (see *PART).
RO	Mass density
PC	Pressure cutoff (≤ 0.0). See Remark 4 .
MULO	Dynamic viscosity (see Remark 1): EQ.0.0: inviscid fluid is assumed. GT.0.0: if MUHI = 0.0 or is not defined, then this is the traditional constant dynamic viscosity coefficient, μ . Otherwise if MUHI > 0.0, then MULO and MUHI are the lower and upper dynamic viscosity limit values for a power-law-like variable viscosity model. LT.0.0: -MULO is a load curve ID defining dynamic viscosity as a function of equivalent strain rate.
MUHI	Dynamic viscosity: EQ.0.0: only MULO is used to define the dynamic viscosity, default

VARIABLE	DESCRIPTION
	<p>LT.0.0: the viscosity can be defined by the user in the file dyn21.F with a routine called f3dm9ale_userdef1. The file is part of the general usermat package. Note that in this case MULO is a parameter for the subroutine.</p> <p>GT.0.0: this is the upper dynamic viscosity limit. This is defined only if RK and RN are defined for the variable viscosity case.</p>
RK	Variable dynamic viscosity multiplier. See Remark 6 .
RN	Variable dynamic viscosity exponent. See Remark 6 .

Remarks:

1. **Deviatoric Viscous Stress.** The null material must be used with an equation-of-state. Pressure cutoff is negative in tension. A (deviatoric) viscous stress of the form

$$\sigma'_{ij} = 2\mu\dot{\epsilon}'_{ij}$$

$$\left[\frac{N}{m^2} \right] \sim \left[\frac{N}{m^2} s \right] \left[\frac{1}{s} \right]$$

is computed for nonzero μ where $\dot{\epsilon}'_{ij}$ is the deviatoric strain rate. μ is the dynamic viscosity. For example, in SI unit system, μ has a unit of [Pa × s].

2. **Hourglass Control Issues.** The null material has no shear stiffness and hourglass control must be used with care. In some applications, the default hourglass coefficient might lead to significant energy losses. In general for fluid(s), the hourglass coefficient QM should be small (in the range 10^{-4} to 10^{-6} for the standard default IHQ choice).
3. **Null Material Properties.** Null material has no yield strength and behaves in a fluid-like manner.
4. **Numerical Cavitation.** The pressure cut-off, PC, must be defined to allow for a material to “numerically” cavitate. In other words, when a material undergoes dilatation above certain magnitude, it should no longer be able to resist this dilatation. Since dilatation stress or pressure is negative, setting PC limit to a very small negative number would allow for the material to cavitate once the pressure in the material goes below this negative value.
5. **Issues with Small Values of Viscosity Exponent.** If the viscosity exponent is less than 1.0 ($RN < 1.0$), then $RN - 1.0 < 0.0$. In this case, at very low equivalent

strain rate, the viscosity can be artificially very high. MULO is then used as the viscosity value.

6. **Empirical Dynamic Viscosity.** The empirical variable dynamic viscosity is typically modeled as a function of *equivalent shear rate* based on experimental data.

$$\mu(\dot{\bar{\gamma}}') = \text{RK} \times \dot{\bar{\gamma}}'^{(\text{RN}-1)}$$

For an incompressible fluid, this may be written equivalently as

$$\mu(\dot{\bar{\epsilon}}') = \text{RK} \times \dot{\bar{\epsilon}}'^{(\text{RN}-1)}$$

The “overbar” denotes a scalar equivalence. The “dot” denotes a time derivative or rate effect. And the “prime” symbol denotes deviatoric or volume preserving components. The *equivalent shear rate* components may be related to the basic definition of (small-strain) strain rate components as follows:

$$\begin{aligned} \dot{\epsilon}_{ij} &= \frac{1}{2} \left(\frac{\partial u_i}{\partial x_j} + \frac{\partial u_j}{\partial x_i} \right) \Rightarrow \dot{\epsilon}'_{ij} = \dot{\epsilon}_{ij} - \delta_{ij} \left(\frac{\dot{\epsilon}_{kk}}{3} \right) \\ \dot{\gamma}_{ij} &= 2\dot{\epsilon}_{ij} \end{aligned}$$

Typically, the 2nd invariant of the deviatoric strain rate tensor is defined as:

$$I_{2\dot{\epsilon}'} = \frac{1}{2} [\dot{\epsilon}'_{ij} \dot{\epsilon}'_{ij}]$$

The equivalent (small-strain) deviatoric strain rate is defined as:

$$\dot{\bar{\epsilon}}' \equiv 2\sqrt{I_{2\dot{\epsilon}'}} = \sqrt{2[\dot{\epsilon}'_{ij} \dot{\epsilon}'_{ij}]} = \sqrt{4[\dot{\epsilon}'_{12}{}^2 + \dot{\epsilon}'_{23}{}^2 + \dot{\epsilon}'_{31}{}^2] + 2[\dot{\epsilon}'_{11}{}^2 + \dot{\epsilon}'_{22}{}^2 + \dot{\epsilon}'_{33}{}^2]}$$

In non-Newtonian literatures, the *equivalent shear rate* is sometimes defined as

$$\dot{\bar{\gamma}} \equiv \sqrt{\frac{\dot{\gamma}_{ij} \dot{\gamma}_{ij}}{2}} = \sqrt{2\dot{\epsilon}_{ij} \dot{\epsilon}_{ij}} = \sqrt{4[\dot{\epsilon}_{12}^2 + \dot{\epsilon}_{23}^2 + \dot{\epsilon}_{31}^2] + 2[\dot{\epsilon}_{11}^2 + \dot{\epsilon}_{22}^2 + \dot{\epsilon}_{33}^2]}$$

It turns out that, (a) for incompressible materials ($\dot{\epsilon}_{kk} = 0$), and (b) the shear terms are equivalent when $i \neq j \rightarrow \dot{\epsilon}_{ij} = \dot{\epsilon}'_{ij}$, the *equivalent shear rate* is algebraically equivalent to the *equivalent (small-strain) deviatoric strain rate*.

$$\dot{\bar{\epsilon}}' = \dot{\bar{\gamma}}'$$

VARIABLE	DESCRIPTION
MID	Material identification. A unique number or label not exceeding 8 characters must be specified.
RO	Mass density
PC	Pressure cutoff (≤ 0.0)
MULO	Dynamic viscosity: <p>GE.0.0: if MUHI = 0.0 or is not defined, then this is the traditional constant dynamic viscosity coefficient, μ. Otherwise if MUHI > 0.0, then MULO and MUHI are the lower and upper dynamic viscosity limit values.</p> <p>LT.0.0: -MULO is a load curve ID defining dynamic viscosity as a function of equivalent strain rate.</p>
MUHI	Upper dynamic viscosity limit (default = 0.0) if MULO > 0. This is defined only if RK and RN are defined for the variable viscosity case.
RK	Variable dynamic viscosity multiplier (see Remark 6 of MAT_ALE_VISCOUS). The viscosity is computed as $\mu(\bar{\epsilon}') = \text{RK} \times \bar{\epsilon}'^{(\text{RN}-1)}$, where the equivalent deviatoric strain rate is $\bar{\epsilon}' = \sqrt{\frac{2}{3} \left[\dot{\epsilon}'_{11}{}^2 + \dot{\epsilon}'_{22}{}^2 + \dot{\epsilon}'_{33}{}^2 + 2(\dot{\epsilon}'_{12}{}^2 + \dot{\epsilon}'_{23}{}^2 + \dot{\epsilon}'_{31}{}^2) \right]}$
RN	Variable dynamic viscosity exponent (see RK)
LCI	Characteristic length, l_{ci} , of the internal turbulent domain
C0 - C6	Internal flow mixing length polynomial coefficients. The one-parameter turbulent mixing length is computed as $l_m = l_{ci} \left[C_0 + C_1 \left(1 - \frac{y}{l_{ci}} \right) + \dots + C_6 \left(1 - \frac{y}{l_{ci}} \right)^6 \right]$
LCX	Characteristic length, l_{cx} , of the external turbulent domain
D0 - D2	External flow mixing length polynomial coefficients. If $y \leq l_{cx}$, then the mixing length is computed as $l_m = [D_0 + D_1 y + D_2 y^2]$.
E0 - E2	External flow mixing length polynomial coefficients. If $y > l_{cx}$, then the mixing length is computed as $l_m = [E_0 + E_1 y + E_2 y^2]$.

Remarks:

1. **Deviatoric Viscous Stress.** The null material must be used with an equation of-state. Pressure cutoff is negative in tension. A (deviatoric) viscous stress of the form

$$\sigma'_{ij} = \mu \dot{\epsilon}'_{ij}$$

$$\left[\frac{N}{m^2} \right] \approx \left[\frac{N}{m^2} s \right] \left[\frac{1}{s} \right]$$

is computed for nonzero μ where $\dot{\epsilon}'_{ij}$ is the deviatoric strain rate. μ is the dynamic viscosity with unit of [Pa × s].

2. **Hourglass Control Issues.** The null material has no shear stiffness and hourglass control must be used with care. In some applications, the default hourglass coefficient might lead to significant energy losses. In general for fluid(s), the hourglass coefficient QM should be small (in the range 10^{-4} to 10^{-6} for the standard default IHQ choice).
3. **Null Material Properties.** The null material has no yield strength and behaves in a fluid-like manner.
4. **Numerical Cavitation.** The pressure cut-off, PC, must be defined to allow for a material to “numerically” cavitate. In other words, when a material undergoes dilatation above certain magnitude, it should no longer be able to resist this dilatation. Since dilatation stress or pressure is negative, setting PC limit to a very small negative number would allow for the material to cavitate once the pressure in the material goes below this negative value.
5. **Issues with Small Value of Viscosity Exponent.** If the viscosity exponent is less than 1.0 (RN < 1.0) then RN – 1.0 < 0.0. In this case, at very low equivalent strain rate, the viscosity can be artificially very high. MULO is then used as the viscosity value.
6. **Turbulent Viscosity.** Turbulence is treated simply by considering its effects on viscosity. Total effective viscosity is the sum of the laminar and turbulent viscosities, $\mu_{\text{eff}} = \mu_l + \mu_t$ where μ_{eff} is the effective viscosity, and μ_t is the turbulent viscosity. The turbulent viscosity is computed based on the Prandtl’s Mixing Length Model,

$$\mu_t = \rho l_m^2 |\nabla \mathbf{v}| .$$

***MAT_ALE_INCOMPRESSIBLE**

***MAT_ALE_05**

***MAT_ALE_INCOMPRESSIBLE**

See *MAT_160.

***MAT_ALE_HERSCHEL**

This may also be referred to as MAT_ALE_06. This is the Herschel-Buckley model. It is an enhancement to the power law viscosity model in *MAT_ALE_VISCOUS (*MAT_ALE_03). Two additional input parameters: the yield stress threshold and critical shear strain rate can be specified to model “rigid-like” material for low strain rates.

It allows the modeling of non-viscous fluids with constant or variable viscosity. The variable viscosity is a function of an equivalent deviatoric strain rate. All *MAT_ALE_ cards apply only to ALE element formulation.

Card 1	1	2	3	4	5	6	7	8
Variable	MID	RO	PC	MULO	MUHI	RK	Not used	RN
Type	I	F	F	F	F	F		F
Defaults	none	none	0.0	0.0	0.0	0.0		0.0

Card 2	1	2	3	4	5	6	7	8
Variable	GDOTC	TA00						
Type	F	F						
Default	none	none						

VARIABLE**DESCRIPTION**

MID	Material identification. A unique number has to be chosen.
RO	Mass density
PC	Pressure cutoff (≤ 0.0); see Remark 4 .
MULO	There are 4 possible cases (see Remark 1): <ol style="list-style-type: none"> 1. If MULO = 0.0, then inviscid fluid is assumed. 2. If MULO > 0.0, and MUHI = 0.0 or is not defined, then this is the traditional constant dynamic viscosity coefficient μ.

VARIABLE	DESCRIPTION
	<ol style="list-style-type: none"> If $MULO > 0.0$, and $MUHI > 0.0$, then $MULO$ and $MUHI$ are lower and upper viscosity limit values for a power-law-like variable viscosity model. If $MULO$ is negative (for example, $MULO = -1$), then a user-input data load curve (with $LCID = 1$) defining dynamic viscosity as a function of equivalent strain rate is used.
MUHI	Upper dynamic viscosity limit (default = 0.0). This is defined only if RK and RN are defined for the variable viscosity case.
RK	k , consistency factor (see Remark 6)
RN	n , power law index (see Remark 6)
GDOTC	$\dot{\gamma}_c$, critical shear strain rate (see Remark 6)
TAO0	τ_0 , yield stress (see Remark 6)

Remarks:

- Viscous Stress.** The null material must be used with an equation-of-state. Pressure cutoff is negative in tension. A (deviatoric) viscous stress of the form

$$\sigma'_{ij} = 2\mu\dot{\epsilon}'_{ij}$$

$$\left[\frac{N}{m^2} \right] \sim \left[\frac{N}{m^2 s} \right] \left[\frac{1}{s} \right]$$

is computed for nonzero μ where $\dot{\epsilon}'_{ij}$ is the deviatoric strain rate. μ is the dynamic viscosity. For example, in SI unit system, μ has a unit of [Pa-s].

- Hourglass Control.** The null material has no shear stiffness and hourglass control must be used with care. In some applications, the default hourglass coefficient might lead to significant energy losses. In general for fluid(s), the hourglass coefficient QM should be small (in the range of 10^{-4} to 10^{-6} for the standard default IHQ choice).
- Yield Strength.** Null material has no yield strength and behaves in a fluid-like manner.
- Pressure Cut-Off.** The pressure cut-off, PC, must be defined to allow for a material to “numerically” cavitate. In other words, when a material undergoes dilatation above certain magnitude, it should no longer be able to resist this

dilatation. Since dilatation stress or pressure is negative, setting PC limit to a very small negative number would allow for the material to cavitate once the pressure in the material goes below this negative value.

- 5. **Viscosity.** If the viscosity exponent is less than 1.0, $RN < 1.0$, then $RN - 1.0 < 0.0$. In this case, at very low equivalent strain rate, the viscosity can be artificially very high. MULO is then used as the viscosity value.
- 6. **Herschel-Buckley Model.** The Herschel-Buckley model employs a large viscosity to model the “rigid-like” behavior for low shear strain rates ($\dot{\gamma} < \dot{\gamma}_c$).

$$\mu(\dot{\gamma}) = \tau_0 \frac{(2-\dot{\gamma}/\dot{\gamma}_c)}{\dot{\gamma}_c} + k[(2 - n) + (n - 1) \frac{\dot{\gamma}}{\dot{\gamma}_c}]$$

A power law is used once the yield stress is passed.

$$\mu(\dot{\gamma}) = \frac{\tau_0}{\dot{\gamma}} + k\left(\frac{\dot{\gamma}}{\dot{\gamma}_c}\right)^{n-1}$$

The shear strain rate is:

$$\dot{\gamma} \equiv \sqrt{\frac{\dot{\gamma}_{ij}\dot{\gamma}_{ij}}{2}} = \sqrt{2\dot{\epsilon}_{ij}\dot{\epsilon}_{ij}} = \sqrt{4[\dot{\epsilon}_{12}^2 + \dot{\epsilon}_{23}^2 + \dot{\epsilon}_{31}^2] + 2[\dot{\epsilon}_{11}^2 + \dot{\epsilon}_{22}^2 + \dot{\epsilon}_{33}^2]}$$

*MAT_SPH_VISCOUS

This may also be referred to as *MAT_SPH_01. This “fluid-like” material model is very similar to Material Type 9 (*MAT_NULL). It models viscous fluids with constant or variable viscosity. The variable viscosity is a function of an equivalent deviatoric strain rate. If an inviscid material is modeled, the deviatoric or viscous stresses are zero, and the equation of state supplies the pressures (or diagonal components of the stress tensor).

Card 1	1	2	3	4	5	6	7	8
Variable	MID	RO	PC	MULO	MUHI	RK	RC	RN
Type	I	F	F	F	F	F	F	F
Defaults	none	none	0.0	0.0	0.0	0.0	0.0	0.0

VARIABLE

DESCRIPTION

MID	Material identification. A unique number or label not exceeding 8 characters must be specified.
RO	Mass density
PC	Pressure cutoff (≤ 0.0). See Remark 4 .
MULO	Dynamic viscosity (see Remark 1): EQ.0.0: inviscid fluid is assumed. GT.0.0: if MUHI = 0.0 or is not defined, then this is the traditional constant dynamic viscosity coefficient, μ . Otherwise if MUHI > 0.0, then MULO and MUHI are the lower and upper dynamic viscosity limit values for a power-law-like variable viscosity model. LT.0.0: -MULO is a load curve ID defining dynamic viscosity as a function of equivalent strain rate.
MUHI	Dynamic viscosity: EQ.0.0: only MULO is used to define the dynamic viscosity, default

VARIABLE	DESCRIPTION
	<p>LT.0.0: the viscosity can be defined by the user in the file dyn21.F with a routine called f3dm9ale_userdef1. The file is part of the general usermat package. Note that in this case MULO is a parameter for the subroutine.</p> <p>GT.0.0: this is the upper dynamic viscosity limit. This is defined only if RK and RN are defined for the variable viscosity case.</p>
RK	Variable dynamic viscosity multiplier. See Remark 6 .
RC	<p>Cross viscosity model:</p> <p>RC.GT.0.0: Cross viscosity model will be used which overwrites all other options. The values of MULO, MUHI, RK and RN will be used in the Cross viscosity model. See Remark 7.</p> <p>RC.LE.0.0: viscosity model based on above fields will be used. See Remark 6.</p>
RN	Variable dynamic viscosity exponent. See Remark 6 .

Remarks:

- Deviatoric Viscous Stress.** This material must be used with an equation-of-state. Pressure cutoff is negative in tension. A (deviatoric) viscous stress of the form

$$\sigma'_{ij} = 2\mu\dot{\epsilon}'_{ij}$$

$$\left[\frac{N}{m^2} \right] \sim \left[\frac{N}{m^2} s \right] \left[\frac{1}{s} \right]$$

is computed for nonzero μ where $\dot{\epsilon}'_{ij}$ is the deviatoric strain rate. μ is the dynamic viscosity. For example, in the SI unit system, μ has units of [Pa × s].

- Hourglass Control Issues.** This material has no shear stiffness and hourglass control must be used with care. In some applications, the default hourglass coefficient might lead to significant energy losses. In general for fluid(s), the hourglass coefficient QM should be small (in the range 10^{-4} to 10^{-6} for the standard default IHQ choice).
- Null Material Properties.** This material since it is based on the null material has no yield strength and behaves in a fluid-like manner.

4. **Numerical Cavitation.** The pressure cut-off, PC, must be defined to allow for a material to “numerically” cavitate. In other words, when a material undergoes dilatation above certain magnitude, it should no longer be able to resist this dilatation. Since dilatation stress or pressure is negative, setting PC limit to a very small negative number would allow for the material to cavitate once the pressure in the material goes below this negative value.
5. **Issues with Small Values of Viscosity Exponent.** If the viscosity exponent is less than 1.0 ($RN < 1.0$), then $RN - 1.0 < 0.0$. In this case, at very low equivalent strain rate, the viscosity can be artificially very high. MULO is then used as the viscosity value.
6. **Empirical Dynamic Viscosity.** The empirical variable dynamic viscosity is typically modeled as a function of *equivalent shear rate* based on experimental data:

$$\mu(\dot{\gamma}') = RK \times \dot{\gamma}'^{(RN-1)} .$$

For an incompressible fluid, this may be written equivalently as

$$\mu(\dot{\epsilon}') = RK \times \dot{\epsilon}'^{(RN-1)} .$$

The “overbar” denotes a scalar equivalence, the “dot” denotes a time derivative or rate effect, and the “prime” symbol denotes deviatoric or volume preserving components. The *equivalent shear rate* components may be related to the basic definition of (small-strain) strain rate components as follows:

$$\begin{aligned} \dot{\epsilon}_{ij} &= \frac{1}{2} \left(\frac{\partial u_i}{\partial x_j} + \frac{\partial u_j}{\partial x_i} \right) \Rightarrow \dot{\epsilon}'_{ij} = \dot{\epsilon}_{ij} - \delta_{ij} \left(\frac{\dot{\epsilon}_{kk}}{3} \right) \\ \dot{\gamma}_{ij} &= 2\dot{\epsilon}_{ij} \end{aligned}$$

Typically, the 2nd invariant of the deviatoric strain rate tensor is defined as:

$$I_{2\dot{\epsilon}'} = \frac{1}{2} [\dot{\epsilon}'_{ij}\dot{\epsilon}'_{ij}] .$$

The equivalent (small-strain) deviatoric strain rate is defined as:

$$\dot{\epsilon}' \equiv 2\sqrt{I_{2\dot{\epsilon}'}} = \sqrt{2[\dot{\epsilon}'_{ij}\dot{\epsilon}'_{ij}]} = \sqrt{4[\dot{\epsilon}'_{12}{}^2 + \dot{\epsilon}'_{23}{}^2 + \dot{\epsilon}'_{31}{}^2] + 2[\dot{\epsilon}'_{11}{}^2 + \dot{\epsilon}'_{22}{}^2 + \dot{\epsilon}'_{33}{}^2]} .$$

In non-Newtonian literatures, the *equivalent shear rate* is sometimes defined as

$$\dot{\gamma} \equiv \sqrt{\frac{\dot{\gamma}_{ij}\dot{\gamma}_{ij}}{2}} = \sqrt{2\dot{\epsilon}_{ij}\dot{\epsilon}_{ij}} = \sqrt{4[\dot{\epsilon}_{12}{}^2 + \dot{\epsilon}_{23}{}^2 + \dot{\epsilon}_{31}{}^2] + 2[\dot{\epsilon}_{11}{}^2 + \dot{\epsilon}_{22}{}^2 + \dot{\epsilon}_{33}{}^2]} .$$

It turns out that when (a) the material is incompressible material ($\dot{\epsilon}_{kk} = 0$) and (b) the shear terms are equivalent (when $i \neq j \rightarrow \dot{\epsilon}_{ij} = \dot{\epsilon}'_{ij}$), the *equivalent shear rate* is algebraically equivalent to the *equivalent (small-strain) deviatoric strain rate*:

$$\dot{\epsilon}' = \dot{\gamma}' .$$

7. **Cross Viscous Model.** The Cross viscous model is one of simplest and most used model for shear-thinning behavior. With shear-thinning behavior, the fluid's viscosity decreases with increasing local shear rate, $\dot{\gamma}$. Thus, using the Cross viscous model, the dynamic viscosity μ is defined as a function of $\dot{\gamma}$:

$$\mu(\dot{\gamma}') = \text{MUHI} + (\text{MULO} - \text{MUHI}) / (1.0 + \text{RK} \times \dot{\gamma}')^{\text{RN}-1} .$$

Here RK and RN are two positive fitting parameters, and MULO and MUHI are the limiting values of the viscosity at low and high shear rates, respectively. RK, RN, MULO and MUHI are fields from the keyword input.

***MAT_SPH_INCOMPRESSIBLE_FLUID**

This may also be referred to as *MAT_SPH_02. This material is only used for the implicit incompressible SPH formulation (FORM = 13 in *CONTROL_SPH).

Card 1	1	2	3	4	5	6	7	8
Variable	MID	RO	MU	GAMMA1	GAMMA2	STENS		
Type	A	F	F	F	F	F		
Defaults	none	none	0.0	0.0	0.0	0.0		

This card is optional.

Card 2	1	2	3	4	5	6	7	8
Variable	CP	LAMBDA						
Type	F	F						
Default	0.0	0.0						

VARIABLE**DESCRIPTION**

MID	Material identification. A unique number or label must be specified (see *PART).
RO	Mass density
MU	Dynamic viscosity
GAMMA1	Numerical surface tension coefficient. For water, we recommend a coefficient of $\gamma_1 = 1000 \text{ m/s}^2$. GAMMA1 is only used if IMAT = 0 in *CONTROL_SPH_INCOMPRESSIBLE.
GAMMA2	Numerical surface tension coefficient. For water, we recommend a coefficient of $\gamma_2 = 1 \text{ m/s}^2$. GAMMA2 is only used if IMAT = 0 in *CONTROL_SPH_INCOMPRESSIBLE.

VARIABLE	DESCRIPTION
STENS	Physical surface tension coefficient. It is only used if IMAT = 1 in *CONTROL_SPH_INCOMPRESSIBLE.
CP	Fluid specific heat. It is used to calculate heat transfer coefficients if IHTC = 1 in *CONTROL_SPH_INCOMPRESSIBLE.
LAMBDA	Fluid thermal conductivity. It is used to calculate heat transfer coefficients if IHTC = 1 in *CONTROL_SPH_INCOMPRESSIBLE.

Remarks:

The surface tension coefficients, GAMMA1 and GAMMA2, are purely numerical and are based on a normalized version of the algorithm presented in [1]. If IMAT = 1 in *CONTROL_SPH_INCOMPRESSIBLE, surface tension is calculated based on physical surface tension properties of the fluid.

References:

- [1] Akinci, N., Akinci, G. & Teschner, M. (2013). Versatile surface tension and adhesion for SPH fluids. ACM Transactions on Graphics (TOG) 32.6 182.

***MAT_SPH_INCOMPRESSIBLE_STRUCTURE**

This may also be referred to as *MAT_SPH_03. This material is only used for the implicit incompressible SPH formulation (FORM = 13 in *CONTROL_SPH) and should be assigned to structures sampled with the *DEFINE_SPH_MESH_SURFACE keyword.

Card 1	1	2	3	4	5	6	7	8
Variable	MID	RO	BETA	ROUGH	ADH			
Type	A	F	F	F	F			
Defaults	none	none	0.0	0.0	0.0			

VARIABLE**DESCRIPTION**

MID	Material identification. A unique number or label must be specified (see *PART).
RO	Mass density. This should be set to the rest density of the fluid. The actual mass of the structure will be calculated from the parent surfaces sampled with the *DEFINE_SPH_MESH_SURFACE keyword.
BETA	Numerical surface adhesion coefficient. For water, a value of $\beta = 1000 \text{ m/s}^2$ is recommended. Only used if IMAT = 0 in *CONTROL_SPH.
ROUGH	Surface roughness coefficient. A friction force between the structure and the fluid is generated based on the viscosity of the fluid scaled by this coefficient. A value between 0.0 and 10.0 is usually recommended.
ADH	Surface adhesion scaling coefficient. It is only used if IMAT = 1 in *CONTROL_SPH. An attractive force between fluid and structure is calculated based on surface tension forces in the fluid and then scaled by ADH.

Remarks:

The surface adhesion coefficient is purely numerical and is based on a normalized version of the algorithm presented in [1].

References:

- [1] Akinci, N., Akinci, G. & Teschner, M. (2013). Versatile surface tension and adhesion for SPH fluids. ACM Transactions on Graphics (TOG) 32.6 182.

***MAT_SPRING_ELASTIC**

This is Material Type 1 for discrete elements (*ELEMENT_DISCRETE). This provides a translational or rotational elastic spring located between two nodes. Only one degree of freedom is connected.

Card 1	1	2	3	4	5	6	7	8
Variable	MID	K						
Type	A8	F						

VARIABLE**DESCRIPTION**

MID	Material identification. A unique number or label not exceeding 8 characters must be specified.
K	Elastic stiffness (force/displacement) or (moment/rotation)

Remarks:

Rotational displacement is measured in radians.

***MAT_DAMPER_VISCOUS**

This is Material Type 2 for discrete elements (*ELEMENT_DISCRETE). This material provides a linear translational or rotational damper located between two nodes. Only one degree of freedom is then connected.

Card 1	1	2	3	4	5	6	7	8
Variable	MID	DC						
Type	A8	F						

VARIABLE**DESCRIPTION**

MID	Material identification. A unique number or label not exceeding 8 characters must be specified.
DC	Damping constant (force/displacement rate) or (moment/rotation rate)

Remarks:

Rotational displacement is measured in radians.

***MAT_SPRING_ELASTOPLASTIC**

This is Material Type 3 for discrete elements (*ELEMENT_DISCRETE). This material provides an elastoplastic translational or rotational spring with isotropic hardening located between two nodes. Only one degree of freedom is connected.

Card 1	1	2	3	4	5	6	7	8
Variable	MID	K	KT	FY				
Type	A8	F	F	F				

VARIABLE**DESCRIPTION**

MID	Material identification. A unique number or label not exceeding 8 characters must be specified.
K	Elastic stiffness (force/displacement) or (moment/rotation)
KT	Tangent stiffness (force/displacement) or (moment/rotation)
FY	Yield (force) or (moment)

Remarks:

Rotational displacement is measured in radians.

***MAT_SPRING_NONLINEAR_ELASTIC**

This is Material Type 4 for discrete elements (*ELEMENT_DISCRETE). This material provides a nonlinear elastic translational and rotational spring with arbitrary force as a function of displacement and moment as a function of rotation, respectively. Optionally, strain rate effects can be considered through a velocity dependent scale factor or defining a table of curves. With the spring located between two nodes, only one degree of freedom is connected.

Card 1	1	2	3	4	5	6	7	8
Variable	MID	LCD	LCR					
Type	A	I	I					

VARIABLE**DESCRIPTION**

MID	Material identification. A unique number or label must be specified (see *PART).
LCD	Load curve ID (see *DEFINE_CURVE) describing force as a function of displacement or moment as a function of rotation relationship. The load curve <i>must</i> define the response in the negative and positive quadrants and pass through point (0,0). Negative data point(s) must come first in the curve definition, where negative values represent compression in the case of a translational spring. LCD may also be a table ID (see *DEFINE_TABLE). The table gives for each loading rate a load curve ID defining the force-displacement (or moment-rotation) curve. Values between the data points are computed by linear interpolation. If a table ID is specified, LCR will be ignored.
LCR	Optional load curve describing scale factor on force or moment as a function of relative velocity or rotational velocity, respectively.

Remarks:

Rotational displacement is measured in radians.

***MAT_DAMPER_NONLINEAR_VISCOUS**

This is Material Type 5 for discrete elements (*ELEMENT_DISCRETE). This material provides a viscous translational damper with an arbitrary force as a function of velocity dependency or a rotational damper with an arbitrary moment as a function of rotational velocity dependency. With the damper located between two nodes, only one degree of freedom is connected.

Card 1	1	2	3	4	5	6	7	8
Variable	MID	LCDR						
Type	A8	I						

VARIABLE

DESCRIPTION

MID

Material identification. A unique number or label not exceeding 8 characters must be specified.

LCDR

Load curve ID defining force as a function of rate-of-displacement relationship or a moment as a function of rate-of-rotation relationship. The load curve *must* define the response in the negative and positive quadrants and pass through point (0,0).

Remarks:

Rotational displacement is measured in radians.

***MAT_SPRING_GENERAL_NONLINEAR**

This is Material Type 6 for discrete elements (*ELEMENT_DISCRETE). This material provides a general nonlinear translational or rotational spring with arbitrary loading and unloading definitions. Optionally, hardening or softening can be defined. With the spring located between two nodes, only one degree of freedom is connected.

Card 1	1	2	3	4	5	6	7	8
Variable	MID	LCDL	LCDU	BETA	TYI	CYI		
Type	A	I	I	F	F	F		

VARIABLE**DESCRIPTION**

MID	Material identification. A unique number or label must be specified (see *PART).
LCDL	Load curve or table ID giving force/torque as a function of displacement/rotation (curve) or as a function of velocity and displacement/rotation (table) for loading; see Figure MS6-1 .
LCDU	Load curve or table ID giving force/torque as a function of displacement/rotation (curve) or as a function of velocity and displacement/rotation (table) for unloading; see Figure MS6-1 .
BETA	Hardening parameter, β : EQ.0.0: Tensile and compressive yield with strain softening (negative or zero slope allowed in the force as a function of displacement load curves). TYI and CYI are not implemented for this option. NE.0.0: Kinematic hardening without strain softening EQ.1.0: Isotropic hardening without strain softening
TYI	Initial yield force in tension (> 0)
CYI	Initial yield force in compression (< 0)

Remarks:

1. **Load Curves.** Load curve points are in the format (displacement, force) or (rotation, moment). The points must be in order starting with the most negative

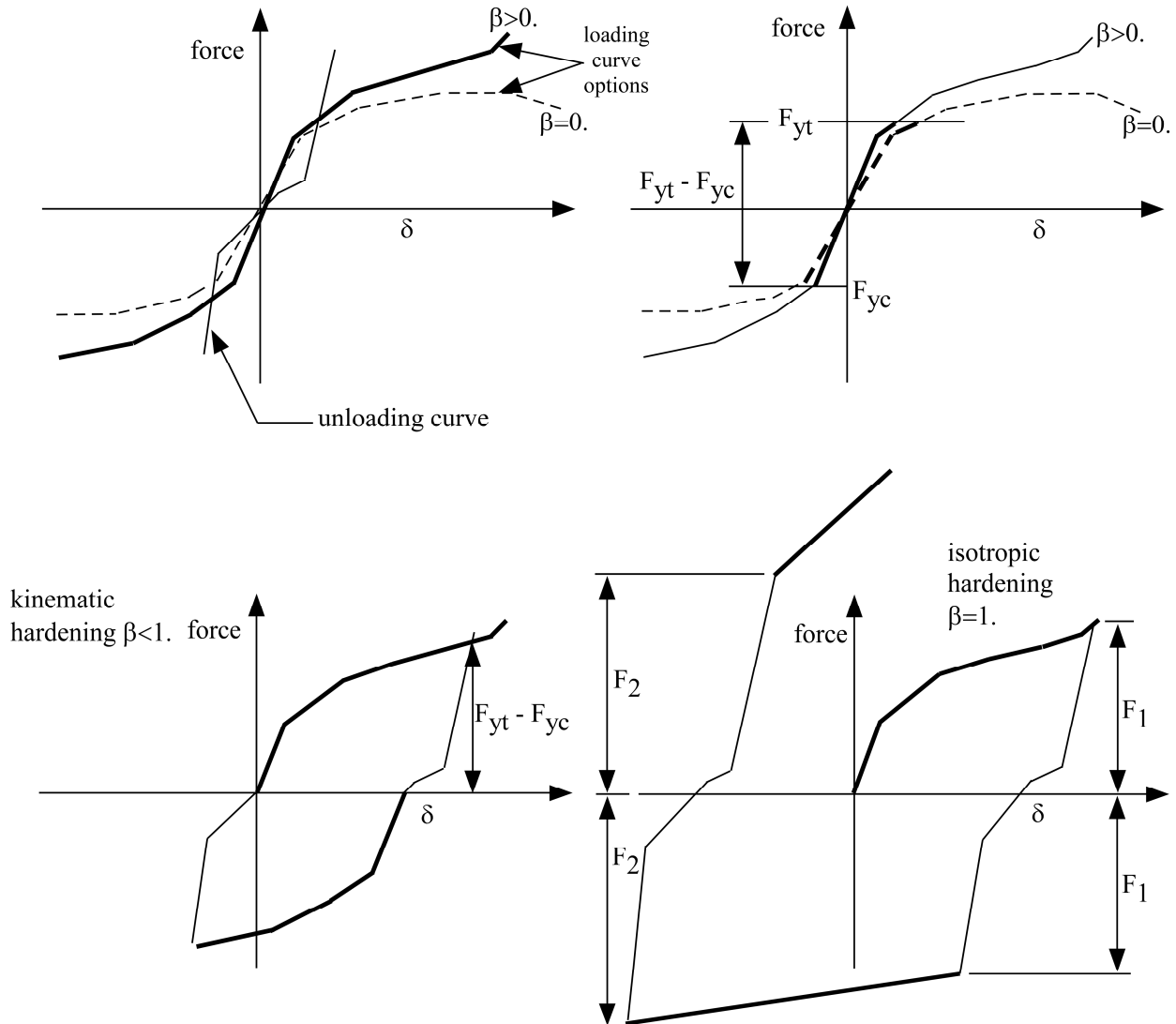

Figure MS6-1. General Nonlinear material for discrete elements

(compressive) displacement or rotation and ending with the most positive (tensile) value. The curves need not be symmetrical.

The displacement origin of the “unloading” curve is arbitrary since it will be shifted as necessary as the element extends and contracts. On reverse yielding the “loading” curve will also be shifted along the displacement re or. rotation axis.

2. **Initial Tensile and Compressive Yield Forces.** The initial tensile and compressive yield forces (TYI and CYI) define a range within which the element remains elastic (meaning the “loading” curve is used for both loading and unloading). If at any time the force in the element exceeds this range, the element is deemed to have yielded, and at all subsequent times the “unloading” curve is used for unloading.

3. **Rotational Displacement.** Rotational displacement is measured in radians.

*MAT_SPRING_MAXWELL

This is Material Type 7 for discrete elements (*ELEMENT_DISCRETE). This material provides a three Parameter Maxwell Viscoelastic translational or rotational spring. Optionally, a cutoff time with a remaining constant force/moment can be defined.

Card 1	1	2	3	4	5	6	7	8
Variable	MID	K0	KI	BETA	TC	FC	COPT	
Type	A8	F	F	F	F	F	F	
Default	none	none	none	none	10 ²⁰	0.0	0.0	

VARIABLE**DESCRIPTION**

MID	Material identification. A unique number or label not exceeding 8 characters must be specified.
K0	K_0 , short time stiffness
KI	K_∞ , long time stiffness
BETA	Decay parameter, β
TC	Cut off time. After this time, a constant force/moment is transmitted.
FC	Force/moment after cutoff time
COPT	Time implementation option: EQ.0.0: incremental time change NE.0.0: continuous time change

Remarks:

1. **Stiffness.** The time varying stiffness, $K(t)$, may be described in terms of the input parameters as

$$K(T) = K_\infty + (K_0 - K_\infty) \exp(-\beta t) .$$

This equation was implemented by Schwer [1991] as either a continuous function of time or incrementally following the approach of Herrmann and Peterson

[1968]. The continuous function of time implementation has the disadvantage of the energy absorber's resistance decaying with increasing time even without deformation. The advantage of the incremental implementation is that an energy absorber must undergo some deformation before its resistance decays, meaning there is no decay until impact, even in delayed impacts. The disadvantage of the incremental implementation is that very rapid decreases in resistance cannot be easily matched.

2. **Rotational Displacement.** Rotational displacement is measured in radians.

***MAT_SPRING_INELASTIC**

This is Material Type 8 for discrete elements (*ELEMENT_DISCRETE). This material provides an inelastic tension or compression only, translational or rotational spring. Optionally, a user-specified unloading stiffness can be taken instead of the maximum loading stiffness.

Card 1	1	2	3	4	5	6	7	8
Variable	MID	LCFD	KU	CTF				
Type	A8	I	F	F				

VARIABLE**DESCRIPTION**

MID	Material identification. A unique number or label not exceeding 8 characters must be specified.
LCFD	Load curve ID describing arbitrary force/torque as a function of displacement/rotation relationship. This curve must be defined in the positive force-displacement quadrant regardless of whether the spring acts in tension or compression.
KU	Unloading stiffness (optional). The maximum of KU and the maximum loading stiffness in the force/displacement or the moment/rotation curve is used for unloading.
CTF	Flag for compression/tension: EQ.-1.0: tension only EQ.1.0: compression only (default)

Remarks:

Rotational displacement is measured in radians.

*MAT_S13

*MAT_SPRING_TRILINEAR_DEGRADING

*MAT_SPRING_TRILINEAR_DEGRADING

This is Material Type 13 for discrete elements (*ELEMENT_DISCRETE). This material allows concrete shearwalls to be modeled as discrete elements under applied seismic loading. It represents cracking of the concrete, yield of the reinforcement and overall failure. Under cyclic loading, the stiffness of the spring degrades, but the strength does not.

Card 1	1	2	3	4	5	6	7	8
Variable	MID	DEFL1	F1	DEFL2	F2	DEFL3	F3	FFLAG
Type	A8	F	F	F	F	F	F	F

VARIABLE

DESCRIPTION

MID	Material identification. A unique number or label not exceeding 8 characters must be specified.
DEFL1	Deflection at point where concrete cracking occurs
F1	Force corresponding to DEFL1
DEFL2	Deflection at point where reinforcement yields
F2	Force corresponding to DEFL2
DEFL3	Deflection at complete failure
F3	Force corresponding to DEFL3
FFLAG	Failure flag

***MAT_SPRING_SQUAT_SHEARWALL**

This is Material Type 14 for discrete elements (*ELEMENT_DISCRETE). This material allows squat shear walls to be modeled using discrete elements. The behavior model captures concrete cracking, reinforcement yield, ultimate strength followed by degradation of strength finally leading to collapse.

Card 1	1	2	3	4	5	6	7	8
Variable	MID	A14	B14	C14	D14	E14	LCID	FSD
Type	A8	F	F	F	F	F	I	F

VARIABLE**DESCRIPTION**

MID	Material identification. A unique number or label not exceeding 8 characters must be specified.
A14	Material coefficient <i>A</i>
B14	Material coefficient <i>B</i>
C14	Material coefficient <i>C</i>
D14	Material coefficient <i>D</i>
E14	Material coefficient <i>E</i>
LCID	Load curve ID referencing the maximum strength envelope curve
FSD	Sustained strength reduction factor

Remarks:

Material coefficients *A*, *B*, *C* and *D* are empirically defined constants used to define the shape of the polynomial curves which govern the cyclic behavior of the discrete element. A different polynomial relationship is used to define the loading and unloading paths allowing energy absorption through hysteresis. Coefficient *E* is used in the definition of the path used to “jump” from the loading path to the unloading path (or vice versa) when a full hysteresis loop is not completed. The load curve referenced is used to define the force displacement characteristics of the shear wall under monotonic loading. The polynomials defining the cyclic behavior refer to this curve. On the second and subsequent loading / unloading cycles, the shear wall will have reduced strength. The variable FSD is the sustained strength reduction factor.

***MAT_SPRING_MUSCLE**

This is Material Type S15 for discrete elements (*ELEMENT_DISCRETE). This material is a Hill-type muscle model with activation. It is for use with discrete elements. The LS-DYNA implementation is due to Dr. J. A. Weiss.

Card 1	1	2	3	4	5	6	7	8
Variable	MID	L0	VMAX	SV	A	FMAX	TL	TV
Type	A8	F	F	F	F	F	F	F
Default	none	1.0	none	1.0	none	none	1.0	1.0

Card 2	1	2	3	4	5	6	7	8
Variable	FPE	LMAX	KSH					
Type	F	F	F					
Default	0.0	none	none					

VARIABLE**DESCRIPTION**

MID	Material identification. A unique number or label not exceeding 8 characters must be specified.
L0	Initial muscle length, L_0
VMAX	Maximum CE shortening velocity, V_{\max}
SV	Scale factor, S_v , for V_{\max} as a function of active state: LT.0.0: absolute value gives load curve ID. GE.0.0: constant value of 1.0 is used.
A	Activation level as a function of time function $a(t)$: LT.0.0: absolute value gives load curve ID. GE.0.0: constant value of A is used.

VARIABLE	DESCRIPTION
FMAX	Peak isometric force, F_{\max}
TL	Active tension as a function of length function, $f_{\text{TL}}(L)$: LT.0.0: absolute value gives load curve ID. GE.0.0: constant value of 1.0 is used.
TV	Active tension as a function of velocity function, $f_{\text{TV}}(V)$: LT.0.0: absolute value gives load curve ID. GE.0.0: constant value of 1.0 is used.
FPE	Normalized force, f_{PE} , as a function of length for parallel elastic element: LT.0.0: absolute value gives load curve ID. EQ.0.0: exponential function is used (see Remarks). GT.0.0: constant value of 0.0 is used.
LMAX	Relative length when F^{PE} reaches F_{\max} . Required if FPE = 0.0 above. See Remarks.
KSH	Constant, K_{sh} , governing the exponential rise of F^{PE} . Required if FPE = 0.0 above. See Remarks.

Remarks:

The material behavior of the muscle model is adapted from the original model proposed by Hill [1938]. Reviews of this model and extensions can be found in Winters [1990] and Zajac [1989]. The most basic Hill-type muscle model consists of a contractile element (CE) and a parallel elastic element (PE) (Figure MS15-1). An additional series elastic element (SEE) can be added to represent tendon compliance.

The main assumptions of the Hill model are that the contractile element is entirely stress free and freely distensible in the resting state and is described exactly by Hill's equation (or some variation). When the muscle is activated, the series and parallel elements are elastic, and the whole muscle is a simple combination of identical sarcomeres in series and parallel. The main criticism of Hill's model is that the division of forces between the parallel elements and the division of extensions between the series elements is arbitrary and cannot be made without introducing auxiliary hypotheses. However, these criticisms apply to *any* discrete element model. Despite these limitations, the Hill model has

become extremely useful for modeling musculoskeletal dynamics, as illustrated by its widespread use today.

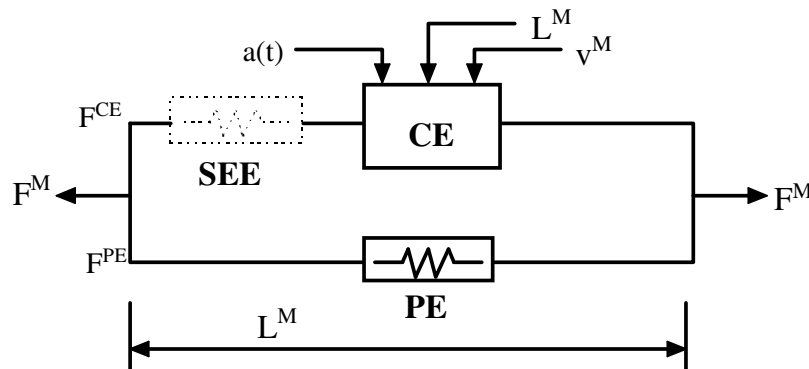

Figure MS15-1. Discrete model for muscle contraction dynamics, based on a Hill-type representation. The total force is the sum of passive force F^{PE} and active force F^{CE} . The passive element (PE) represents energy storage from muscle elasticity, while the contractile element (CE) represents force generation by the muscle. The series elastic element (SEE), shown in dashed lines, is often neglected when a series tendon compliance is included. Here, $a(t)$ is the activation level, L^M is the length of the muscle, and V^M is the shortening velocity of the muscle.

When the contractile element (CE) of the Hill model is inactive, the entire resistance to elongation is provided by the PE element and the tendon load-elongation behavior. As activation is increased, force then passes through the CE side of the parallel Hill model, providing the contractile dynamics. The original Hill model accommodated only full activation - this limitation is circumvented in the present implementation by using the modification suggested by Winters (1990). The main features of his approach were to realize that the CE force-velocity input force equals the CE tension-length output force. This yields a three-dimensional curve to describe the force-velocity-length relationship of the CE. If the force-velocity y -intercept scales with activation, then given the activation, length and velocity, the CE force can be determined.

Without the SEE, the total force in the muscle F^M is the sum of the force in the CE and the PE because they are in parallel:

$$F^M = F^{PE} + F^{CE} .$$

The relationships defining the force generated by the CE and PE as a function of L^M (length of the muscle), V^M (shortening velocity of the muscle) and $a(t)$ are often scaled by F_{max} , the peak isometric force (p. 80, Winters 1990), L_0 , the initial length of the muscle (p. 81, Winters 1990), and V_{max} , the maximum unloaded CE shortening velocity (p. 80, Winters 1990). From these, dimensionless length and velocity can be defined as:

$$L = L^M / L_0$$

$$V = \frac{V^M}{V_{\max} \times S_v[a(t)]}$$

Here, S_v scales the maximum CE shortening velocity V_{\max} and changes with activation level $a(t)$. This has been suggested by several researchers, that is, Winters and Stark [1985]. The activation level specifies the level of muscle stimulation as a function of time. Both have values between 0 and 1. The functions $S_v[a(t)]$ and $a(t)$ are specified using load curves in LS-DYNA, but the default values of $S_v = 1$ and $a(t) = 0$ can also be used. Note that L is always positive and that V is positive for lengthening and negative for shortening.

The relationship between F^{CE} , V and L was proposed by Bahler et al. [1967]. A three-dimensional relationship between these quantities is now considered standard for computer implementations of Hill-type muscle models [Winters 1990]. It can be written in dimensionless form as:

$$F^{\text{CE}} = a(t) \times F_{\max} \times f_{\text{TL}}(L) \times f_{\text{TV}}(V).$$

Here, $f_{\text{TL}}(L)$ and $f_{\text{TV}}(V)$ are the tension-length and tension-velocity functions for active skeletal muscle. Thus, if current values of L^M , V^M , and $a(t)$ are known, then F^{CE} can be determined (Figure MS15-1).

If $F_{\text{PE}} = 0.0$, the force in the parallel elastic element, F^{PE} , is determined directly from the current length of the muscle using an exponential relationship [Winters 1990]:

$$f_{\text{PE}} = \frac{F^{\text{PE}}}{F_{\text{MAX}}} = \begin{cases} 0 & L \leq 1 \\ \frac{1}{\exp(K_{\text{sh}}) - 1} \left\{ \exp\left[\frac{K_{\text{sh}}}{L_{\text{max}}}(L - 1)\right] - 1 \right\} & L > 1 \end{cases}$$

Here, L_{max} is the dimensionless length at which the force F_{max} occurs, and K_{sh} is a dimensionless shape parameter controlling the rate of rise of the exponential. Alternatively, the user can define a custom f_{PE} curve giving tabular values of normalized force as a function of dimensionless length as a load curve.

For computation of the total force developed in the muscle F^{M} , the functions for the tension-length $f_{\text{TL}}(L)$ and force-velocity f_{TV} relationships used in the Hill element must be defined. These relationships have been available for over 50 years but have been refined to allow for behavior such as active lengthening. The active tension-length curve $f_{\text{TL}}(L)$ describes the fact that isometric muscle force development is a function of length, with the maximum force occurring at an optimal length. According to Winters, this optimal length is typically around $L = 1.05$, and the force drops off for shorter or longer lengths, approaching zero force for $L = 0.4$ and $L = 1.5$. Thus the curve has a bell-shape. Because of the variability in this curve between muscles, the user must specify the function $f_{\text{TL}}(L)$ using a load curve, specifying pairs of points representing the normalized force (with values between 0 and 1) and normalized length L . See Figure MS15-2.

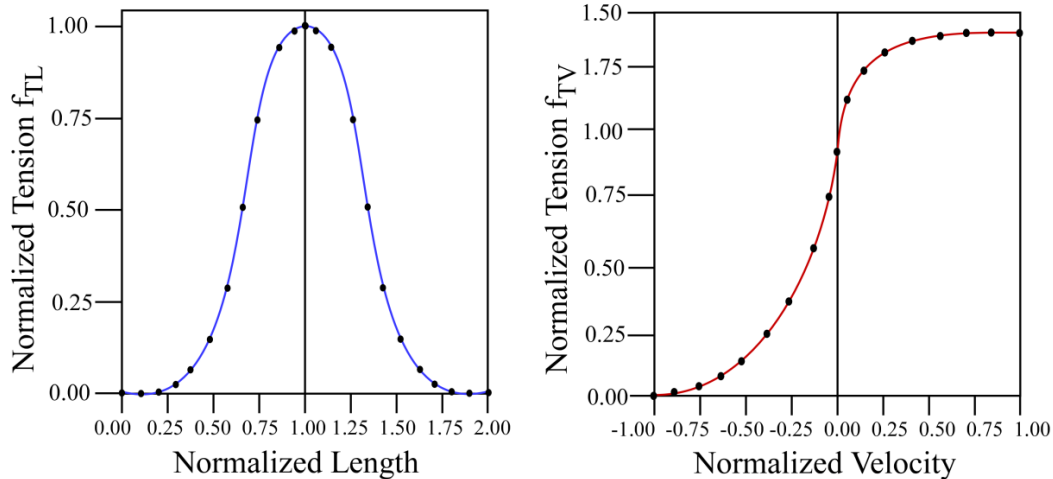

Figure MS15-2. Typical normalized tension-length (TL) and tension-velocity (TV) curves for skeletal muscle.

The active tension-velocity relationship $f_{TV}(V)$ used in the muscle model is mainly due to the original work of Hill. Note that the dimensionless velocity V is used. When $V = 0.0$, the normalized tension is typically chosen to have a value of 1.0. When V is greater than or equal to 0.0, muscle lengthening occurs. As V increases, the function is typically designed so that the force increases from a value of 1.0 and asymptotes towards a value near 1.4 as shown in Figure MS15-2. When V is less than zero, muscle shortening occurs and the classic Hill equation hyperbola is used to drop the normalized tension to 0.0 as shown in Figure MS15-2. The user must specify the function $f_{TV}(V)$ using a load curve, specifying pairs of points representing the normalized tension (with values between 0.0 and 1.0) and normalized velocity V .

MAT_SEATBELT**MAT_B01*****MAT_SEATBELT_{OPTION}**

This is Material Type B01. It defines a seat belt material.

Available options include:

2D

Card 1	1	2	3	4	5	6	7	8
Variable	MID	MPUL	LLCID	ULCID	LMIN	CSE	DAMP	E
Type	A	F	I	I	F	F	F	F
Default	0	0.0	0	0	0.0	0.0	0.1	0.0

Bending/Compression Parameter Card. Additional card for $E > 0.0$.

Card 2	1	2	3	4	5	6	7	8
Variable	A	I	J	AS	F	M	R	
Type	F	F	F	F	F	F	F	
Default	0.0	0.0	2*1	A	10^{20}	10^{20}	0.05	

2D Card. Additional 1st card for the 2D keyword option.

Card 3	1	2	3	4	5	6	7	8
Variable	P1DOFF	FORM	ECOAT	TCOAT	SCOAT	EB	PRBA	PRAB
Type	I	I	F	F	F	F	F	F
Default	0	0	0.0	0.0	0.0	-0.1	0.3	PRBA

2D Card. Optional 2nd card for the 2D keyword option.

Card 4	1	2	3	4	5	6	7	8
Variable	GAB							
Type	F							
Default	↓							

VARIABLE

DESCRIPTION

MID	Belt material number. A unique number or label must be specified (see *PART).
MPUL	Mass per unit length
LLCID	Curve or table ID for loading. LLCID can be either a single curve (force as a function of engineering strain) or a table defining a set of strain-rate dependent load curves.
ULCID	Load curve identification for unloading (force as a function of engineering strain)
LMIN	Minimum length (for elements connected to slip rings and retractors); see Remark 4 .
CSE	Compressive stress elimination option which applies to shell elements only, available since r137465/dev for non-zero FORM. The old recommended option of CSE = 2, available since R8, still works if and only if FORM = 0. For non-zero FORM: EQ.0.0: don't eliminate compressive stresses in shell fabric. EQ.1.0: eliminate compressive stresses in shell fabric.
DAMP	Optional Rayleigh damping coefficient, which applies to shell elements only. A coefficient value of 0.10 is the default corresponding to 10% of critical damping. Sometimes smaller or larger values work better.
E	Young's modulus for bending/compression stiffness, when positive, the optional card is invoked. See Remark 5 .
A	Cross sectional area for bending/compression stiffness; see remarks.

VARIABLE	DESCRIPTION
I	Area moment of inertia for bending/compression stiffness; see Remark 5 .
J	Torsional constant for bending/compression stiffness; see Remark 5 .
AS	Shear area for bending/compression stiffness; see Remark 5 .
F	Maximum force in compression/tension; see Remark 5 .
M	Maximum torque; see Remark 5 .
R	Rotational mass scaling factor; see Remark 5 .
P1DOFF	Part ID offset for internally created 1D, bar-type, belt parts for 2D seatbelt of this material, that is, the IDs of newly created 1D belt parts will be P1DOFF + 1, P1DOFF + 2, ... If zero, the maximum ID of user-defined parts is used as the part ID offset.
FORM	Formulation of the translated fabric material; see FORM of *MAT_-FABRIC for details. FORM = 0 was used since R8 and non-zero FORM is available since r137465/dev.
ECOAT	Young's modulus of coat material for FORM = -14; see *MAT_-FABRIC for details. EQ.0.0: ECOAT is the Young's modulus determined by LS-DYNA. GT.0.0: ECOAT is the Young's modulus to be used for coat material. LT.0.0: ECOAT is the ratio of coat material's Young's modulus to that of the fabric shell which is determined by LS-DYNA.
TCOAT	Thickness of coat material for FORM = -14; see *MAT_-FABRIC for details.
SCOAT	Yield stress of coat material for FORM = -14; see *MAT_-FABRIC for details. If not defined, the coat material is assumed to be elastic.
EB	Young's modulus along transverse direction; see *MAT_-FABRIC for details.

VARIABLE	DESCRIPTION
	EQ.0.0: The Young’s modulus along transverse direction is 10% of the Young’s determined by LS-DYNA based on the loading curve, LLCID.
	LT.0.0: EB is the ratio of Young’s modulus along the transverse direction to the Young’s modulus determined by LS-DYNA based on the loading curve, LLCID.
	GT.0.0: EB is the Young’s modulus along the transverse direction.
PRBA (PRAB)	Minor (Major) Poisson’s ratio <i>ba</i> (<i>ab</i>) direction
GAB	Shear modulus in the <i>ab</i> direction. Set to a very small value for an isotropic elastic material; see *MAT_FABRIC. If defined to be zero, a default value of $EA / (2 \times (1 + PRBA))$ will be used where EA is the Young’s modulus along the longitudinal direction and is set to 1% of the Young’s modulus determined by LS-DYNA according to the loading curve, LLCID.

Remarks:

- 1. Loading and Unloading.** Each belt material defines stretch characteristics and mass properties for a set of belt elements. The user enters a load curve for loading, the points of which are (Strain, Force). Strain is defined as engineering strain, that is,

$$\text{Strain} = \frac{\text{current length}}{\text{initial length}} - 1.0$$

Another similar curve is entered to describe the unloading behavior. Both load curves should start at the origin (0,0) and contain positive force and strain values only. The belt material is tension only with zero forces being generated whenever the strain becomes negative. The first non-zero point on the loading curve defines the initial yield point of the material. On unloading, the unloading curve is shifted along the strain axis until it crosses the loading curve at the “yield” point from which unloading commences. If the initial yield has not yet been exceeded or if the origin of the (shifted) unloading curve is at negative strain, the original loading curves will be used for both loading and unloading. If the strain is less than the strain at the origin of the unloading curve, the belt is slack and no force is generated. Otherwise, forces will then be determined by the unloading curve for unloading and reloading until the strain again exceeds yield after which the loading curves will again be used.

2. **Damping.** A small amount of damping is automatically included. This reduces high frequency oscillation, but, with realistic force-strain input characteristics and loading rates, does not significantly alter the overall forces-strain performance. The damping force opposes the relative motion of the nodes and is limited by stability:

$$D = \frac{0.1 \times \text{mass} \times \text{relative velocity}}{\text{time step size}}$$

In addition, the magnitude of the damping force is limited to one-tenth of the force calculated from the force-strain relationship and is zero when the belt is slack. Damping forces are not applied to elements attached to slings and retractors.

3. **Nodal Masses.** MPUL, the mass per unit length, is used to calculate the nodal masses during initialization.
4. **Minimum Length.** LMIN, the “minimum” length, controls the shortest length allowed in any element. It also determines when an element passes through slings or is absorbed into the retractors. A large LMIN causes elements to easily pass through the slings. A small LMIN leads to a smaller time step and possible instability for 2D belts. One tenth of a typical initial element length is a good choice for a 1D belt. For a 2D belt, a larger value of 0.3 can be used for better robustness and a larger time step.
5. **Bending and Compression Stiffness for 1D Elements.** Since one-dimensional elements do not possess any bending or compression stiffness, dynamic analysis is mandatory during an implicit analysis that includes belts. However, one dimensional belt elements *can* be used in implicit statics by associating them with bending/compression properties with the first optional card. Two-dimensional belt elements are not supported with this feature.

To achieve bending and compression stiffness in one-dimensional belts, the belt element is overlaid with a Belytschko-Schwer beam element (see *SECTION_BEAM, ELFORM = 2, for a more comprehensive description of fields A, I, J and AS) with circular cross section. These elements have 6 degrees of freedom including rotational degrees of freedom. The material used in this context is an elastic-ideal-plastic material where the elastic part is governed by the Young’s modulus, E . Two yield values, F (the maximum compression/tension force) and M (the maximum torque), are used as upper bounds for the resultants. The bending/compression forces and moments from this contribution are accumulated to the force from the seatbelt itself. Since the main purpose is to eliminate the singularities in bending and compression, it is recommended to choose the bending and compression properties in the optional card carefully so as to not significantly influence the overall response.

For the sake of completeness, this feature is also supported by the explicit integrator; therefore, a rotational nodal mass is needed. Each of the two nodes of an element gets a contribution from the belt that is calculated as $RM_{ASS} = R \times (MASS/2) \times I/A$, where $MASS$ indicates the total translational mass of the belt element and R is a scaling factor input by the user. The translational mass is not modified. The bending and compression properties do not affect the stable time step. If the belts are used *without* sliprings, then incorporating this feature is virtually equivalent to adding Belytschko-Schwer beams on top of conventional belt elements as part of the modelling strategy. If sliprings *are* used, this feature is necessary to properly support the flow of material through the sliprings and swapping of belt elements across sliprings. Retractors cannot be used with this feature.

***MAT_THERMAL**

The *MAT_THERMAL cards allow thermal properties to be defined in coupled structural/thermal and thermal only analyses; see *CONTROL_SOLUTION. Thermal properties must be defined for all elements in such analyses.

Thermal material properties are specified by a thermal material ID number (TMID). This number is independent of the material ID number (MID) defined on all other *MAT... property cards. In the same analysis identical TMID and MID numbers may exist. The TMID and MID numbers are related through the *PART card.

Available thermal materials are:

- *MAT_THERMAL_ISOTROPIC
- *MAT_THERMAL_ORTHOTROPIC
- *MAT_THERMAL_ISOTROPIC_TD
- *MAT_THERMAL_ORTHOTROPIC_TD
- *MAT_THERMAL_DISCRETE_BEAM
- *MAT_THERMAL_CHEMICAL_REACTION
- *MAT_THERMAL_CWM
- *MAT_THERMAL_ORTHOTROPIC_TD_LC
- *MAT_THERMAL_ISOTROPIC_PHASE_CHANGE
- *MAT_THERMAL_ISOTROPIC_TD_LC
- *MAT_THERMAL_USER_DEFINED
- *MAT_THERMAL_CHEMICAL_REACTION_ORTHOTROPIC

***MAT_THERMAL_ISOTROPIC**

This is Thermal Material Type 1. With this material, isotropic thermal properties can be defined.

Card 1	1	2	3	4	5	6	7	8
Variable	TMID	TRO	TGRLC	TGMULT	TLAT	HLAT		
Type	A	F	F	F	F	F		

Card 2	1	2	3	4	5	6	7	8
Variable	HC	TC						
Type	F	F						

VARIABLE**DESCRIPTION**

TMID	Thermal material identification. A unique number or must be specified (see *PART).
TRO	Thermal density: EQ.0.0: Default to structural density
TGRLC	Thermal generation rate (see *DEFINE_CURVE). See Remark 2 . GT.0: Load curve ID giving thermal generation rate as a function of time EQ.0: Thermal generation rate is the constant multiplier, TGMULT. LT.0: TGRLC is a load curve ID defining thermal generation rate as a function of temperature.
TGMULT	Thermal generation rate multiplier: EQ.0.0: No heat generation
TLAT	Phase change temperature
HLAT	Latent heat

VARIABLE	DESCRIPTION
HC	Specific heat
TC	Thermal conductivity

Remarks:

- Supported Load Curves.** *DEFINE_CURVE_FUNCTION is fully supported for *MAT_THERMAL_ISOTROPIC (added in revision 113488).
- Thermal Generation Rate.** TGRLC is similar to the volumetric heat generation rate in *LOAD_HEAT_GENERATION. It has units W/m³ in the SI units system.

Example:

```

*MAT_THERMAL_ISOTROPIC
      1      2700.      210      1.0
      904.      222.
*define_curve_function
210
if(lc211,lc10,lc12,lc11)
*define_curve
211
0,-200
2.0,-200
*define_curve
10
0,1.43e+07
100,1.43e+07
*define_curve
11
0,2.43e+07
100,2.43e+07
*define_curve
12
0,3.43e+07
100,3.43e+07

```

***MAT_THERMAL_ORTHOTROPIC**

This is Thermal Material Type 2. It allows orthotropic thermal properties to be defined.

Card 1	1	2	3	4	5	6	7	8
Variable	TMID	TRO	TGRLC	TGMULT	AOPT	TLAT	HLAT	
Type	A	F	F	F	F	F	F	

Card 2	1	2	3	4	5	6	7	8
Variable	HC	K1	K2	K3				
Type	F	F	F	F				

Card 3	1	2	3	4	5	6	7	8
Variable	XP	YP	ZP	A1	A2	A3		
Type	F	F	F	F	F	F		

Card 4	1	2	3	4	5	6	7	8
Variable	D1	D2	D3					
Type	F	F	F					

VARIABLE**DESCRIPTION**

TMID

Thermal material identification. A unique number or label must be specified (see *PART).

TRO

Thermal density:

EQ.0.0: Default to structural density

VARIABLE	DESCRIPTION
TGRLC	<p>Thermal generation rate (see *DEFINE_CURVE). See Remark 1.</p> <p>GT.0: Load curve ID defining thermal generation rate as a function of time</p> <p>EQ.0: Thermal generation rate is the constant multiplier, TGMULT.</p> <p>LT.0: TGRLC is a load curve ID giving thermal generation rate as a function of temperature.</p>
TGMULT	<p>Thermal generation rate multiplier:</p> <p>EQ.0.0: No heat generation</p>
AOPT	<p>Material axes definition:</p> <p>EQ.0.0: Locally orthotropic with material axes by element nodes N1, N2 and N4</p> <p>EQ.1.0: Locally orthotropic with material axes determined by a point in space and global location of element center</p> <p>EQ.2.0: Globally orthotropic with material axes determined by vectors</p> <p>EQ.3.0: Locally orthotropic with first material axis orthogonal to element normal (defined by element nodes N1, N2 and N4) and to a vector \mathbf{d}. The third material direction corresponds to element normal.</p> <p>EQ.4.0: Local orthogonal in cylindrical coordinates with the material axes determined by a vector \mathbf{d}, and an originating point, P, which define the centerline axis.</p>
TLAT	Phase change temperature
HLAT	Latent heat
HC	Specific heat
K1	Thermal conductivity, K_1 , in local x -direction
K2	Thermal conductivity, K_2 , in local y -direction
K3	Thermal conductivity, K_3 , in local z -direction
XP, YP, ZP	Coordinates of point p for AOPT = 1 and 4

VARIABLE	DESCRIPTION
A1, A2, A3	Components of vector a for AOPT = 2
D1, D2, D3	Components of vector d for AOPT = 2, 3 and 4

Remarks:

1. **Thermal Generation Rate.** TGRLC is similar to the volumetric heat generation rate in *LOAD_HEAT_GENERATION. It has units W/m³ in the SI units system.

***MAT_THERMAL_ISOTROPIC_TD**

This is Thermal Material Type 3. The isotropic properties can be temperature dependent. The temperature dependency is defined by specifying a minimum of two and a maximum of eight data points. You should define the properties for the temperature range that the material will see in the analysis.

Card 1	1	2	3	4	5	6	7	8
Variable	TMID	TRO	TGRLC	TGMULT	TLAT	HLAT		
Type	A	F	F	F	F	F		

Card 2	1	2	3	4	5	6	7	8
Variable	T1	T2	T3	T4	T5	T6	T7	T8
Type	F	F	F	F	F	F	F	F

Card 3	1	2	3	4	5	6	7	8
Variable	C1	C2	C3	C4	C5	C6	C7	C8
Type	F	F	F	F	F	F	F	F

Card 4	1	2	3	4	5	6	7	8
Variable	K1	K2	K3	K4	K5	K6	K7	K8
Type	F	F	F	F	F	F	F	F

VARIABLE

DESCRIPTION

TMID

Thermal material identification. A unique number or label must be specified (see *PART).

VARIABLE	DESCRIPTION
TRO	Thermal density: EQ.0.0: Default to structural density
TGRLC	Thermal generation rate (see *DEFINE_CURVE). See Remark 1 . GT.0: Load curve ID giving thermal generation rate as a function of time EQ.0: Thermal generation rate is the constant multiplier, TGMULT. LT.0: TGRLC is a load curve ID defining thermal generation rate as a function of temperature.
TGMULT	Thermal generation rate multiplier: EQ.0.0: No heat generation
TLAT	Phase change temperature
HLAT	Latent heat
T1, ..., T8	Temperatures: T1, ..., T8
C1, ..., C8	Specific heat at: T1, ..., T8
K1, ..., K8	Thermal conductivity at: T1, ..., T8

Remarks:

1. **Thermal Generation Rate.** TGRLC is similar to the volumetric heat generation rate in *LOAD_HEAT_GENERATION. It has units W/m^3 in the SI units system.

*MAT_THERMAL_ORTHOTROPIC_TD

This is Thermal Material Type 4. It allows temperature dependent orthotropic properties to be defined. The temperature dependency is defined by specifying a minimum of two and a maximum of eight data points. The properties must be defined for the temperature range that the material will see in the analysis.

Card Summary:

Card 1. This card is required.

TMID	TRO	TGRLC	TGMULT	AOPT	TLAT	HLAT	
------	-----	-------	--------	------	------	------	--

Card 2. This card is required.

T1	T2	T3	T4	T5	T6	T7	T8
----	----	----	----	----	----	----	----

Card 3. This card is required.

C1	C2	C3	C4	C5	C6	C7	C8
----	----	----	----	----	----	----	----

Card 4. This card is required.

(K1)1	(K1)2	(K1)3	(K1)4	(K1)5	(K1)6	(K1)7	(K1)8
-------	-------	-------	-------	-------	-------	-------	-------

Card 5. This card is required.

(K2)1	(K2)2	(K2)3	(K2)4	(K2)5	(K2)6	(K2)7	(K2)8
-------	-------	-------	-------	-------	-------	-------	-------

Card 6. This card is required.

(K3)1	(K3)2	(K3)3	(K3)4	(K3)5	(K3)6	(K3)7	(K3)8
-------	-------	-------	-------	-------	-------	-------	-------

Card 7. This card is required.

XP	YP	ZP	A1	A2	A3		
----	----	----	----	----	----	--	--

Card 8. This card is required.

D1	D2	D3					
----	----	----	--	--	--	--	--

Data Card Definitions:

Card 1	1	2	3	4	5	6	7	8
Variable	TMID	TRO	TGRLC	TGMULT	AOPT	TLAT	HLAT	
Type	A	F	F	F	F	F	F	

VARIABLE**DESCRIPTION**

TMID	Thermal material identification. A unique number or label must be specified (see *PART).
TRO	Thermal density: EQ.0.0: Default to structural density
TGRLC	Thermal generation rate (see *DEFINE_CURVE). See Remark 1 . GT.0: Load curve ID defining thermal generation rate as a function of time EQ.0: Thermal generation rate is the constant multiplier, TGMULT. LT.0: TGRLC is a load curve ID defining thermal generation rate as a function of temperature.
TGMULT	Thermal generation rate multiplier: EQ.0.0: No heat generation
AOPT	Material axes definition (see *MAT_OPTIONTROPIC_ELASTIC for a more complete description): EQ.0.0: Locally orthotropic with material axes by element nodes N1, N2 and N4 EQ.1.0: Locally orthotropic with material axes determined by a point in space and global location of element center EQ.2.0: Globally orthotropic with material axes determined by vectors EQ.3.0: Locally orthotropic with first material axis orthogonal to element normal (defined by element nodes N1, N2 and N4) and to a vector d - Third material direction corresponds to element normal.

VARIABLE**DESCRIPTION**

EQ.4.0: Local orthogonal in cylindrical coordinates with the material axes determined by a vector \mathbf{d} , and an originating point, P , which define the centerline axis.

TLAT Phase change temperature

HLAT Latent heat

Card 2	1	2	3	4	5	6	7	8
Variable	T1	T2	T3	T4	T5	T6	T7	T8
Type	F	F	F	F	F	F	F	F

VARIABLE**DESCRIPTION**

T1, ..., T8 Temperatures: T1, ..., T8

Card 3	1	2	3	4	5	6	7	8
Variable	C1	C2	C3	C4	C5	C6	C7	C8
Type	F	F	F	F	F	F	F	F

VARIABLE**DESCRIPTION**

C1, ..., C8 Specific heat at T1, ..., T8

Card 4	1	2	3	4	5	6	7	8
Variable	(K1)1	(K1)2	(K1)3	(K1)4	(K1)5	(K1)6	(K1)7	(K1)8
Type	F	F	F	F	F	F	F	F

VARIABLE**DESCRIPTION**

(K1)1, ..., (K1)8 Thermal conductivity K_1 in the local x -direction at T1, ..., T8

Card 5	1	2	3	4	5	6	7	8
Variable	(K2)1	(K2)2	(K2)3	(K2)4	(K2)5	(K2)6	(K2)7	(K2)8
Type	F	F	F	F	F	F	F	F

VARIABLE**DESCRIPTION**(K2)1, ...,
(K2)8Thermal conductivity K_2 in the local y -direction at T1, ..., T8

Card 6	1	2	3	4	5	6	7	8
Variable	(K3)1	(K3)2	(K3)3	(K3)4	(K3)5	(K3)6	(K3)7	(K3)8
Type	F	F	F	F	F	F	F	F

VARIABLE**DESCRIPTION**(K3)1, ...,
(K3)8Thermal conductivity K_3 in the local z -direction at T1, ..., T8

Card 7	1	2	3	4	5	6	7	8
Variable	XP	YP	ZP	A1	A2	A3		
Type	F	F	F	F	F	F		

VARIABLE**DESCRIPTION**

XP, YP, ZP

Coordinates of point p for AOPT = 1 and 4

A1, A2, A3

Components of vector \mathbf{a} for AOPT = 2

Card 8	1	2	3	4	5	6	7	8
Variable	D1	D2	D3					
Type	F	F	F					

VARIABLE

DESCRIPTION

D1, D2, D3

Components of vector **d** for AOPT = 2, 3 and 4

Remarks:

1. **Thermal Generation Rate.** TGRLC is similar to the volumetric heat generation rate in *LOAD_HEAT_GENERATION and has units W/m^3 in the SI units system.

***MAT_THERMAL_DISCRETE_BEAM**

This is thermal material type 5. It defines properties for discrete beams. It is only applicable when used with *SECTION_BEAM elform = 6.

Card 1	1	2	3	4	5	6	7	8
Variable	TMID	TRO						
Type	A8	F						

Card 2	1	2	3	4	5	6	7	8
Variable	HC	TC						
Type	F	F						

VARIABLE**DESCRIPTION**

TMID	Thermal material identification. A unique number or label not exceeding 8 characters must be specified.
TRO	Thermal density: EQ.0.0: default to structural density.
HC	Specific heat
TC	Thermal conductance (SI units are W/K) $HC = (\text{heat transfer coefficient}) \times (\text{beam cross section area})$ $[W/K] = [W / m^2 K] * [m^2]$

Note:

A beam cross section area is not defined on the SECTION_BEAM keyword for an elform = 6 discrete beam. A beam cross section area is needed for heat transfer calculations. Therefore, the cross section area is lumped into the value entered for HC.

*MAT_THERMAL_CHEMICAL_REACTION

This is thermal material type 6. The chemical species making up this material undergo specified chemical reactions. A maximum of 8 species and 8 chemical reactions can be defined. The thermal material properties of a finite element undergoing chemical reactions are calculated based on a mixture law consisting of those chemical species currently present in the element. The dependence of the chemical reaction rate on temperature is described by the Arrhenius equation. Time step splitting is used to couple the system of ordinary differential equations describing the chemical reaction kinetics to the system of partial differential equations describing the diffusion of heat.

Card Summary:

Card 1. This card is required.

TMID	NCHSP	NCHRX	ICEND	CEND	GASC	FID	MF
------	-------	-------	-------	------	------	-----	----

Card 2. This card must be included but all parameters can be set to 0 if no filler material is present.

RHOf	LCCf	LCKf	Vf				
------	------	------	----	--	--	--	--

Card 3. Include one card for each of the NCHSP species.

RH <i>i</i>	LCC <i>i</i>	LCK <i>i</i>	Vf <i>i</i>	MW <i>i</i>			
-------------	--------------	--------------	-------------	-------------	--	--	--

Card 4. Include one card for each of the NCHSP species.

RC/1	RC/2	RC/3	RC/4	RC/5	RC/6	RC/7	RC/8
------	------	------	------	------	------	------	------

Card 5. Include one card for each of the NCHSP species.

RX/1	RX/2	RX/3	RX/4	RX/5	RX/6	RX/7	RX/8
------	------	------	------	------	------	------	------

Card 6. This card is required.

LCZ1	LCZ2	LCZ3	LCZ4	LCZ5	LCZ6	LCZ7	LCZ8
------	------	------	------	------	------	------	------

Card 7. This card is required.

E1	E2	E3	E4	E5	E6	E7	E8
----	----	----	----	----	----	----	----

Card 8. This card is required.

Q1	Q2	Q3	Q4	Q5	Q6	Q7	Q8
----	----	----	----	----	----	----	----

Data Card Definitions:

Card 1	1	2	3	4	5	6	7	8
Variable	TMID	NCHSP	NCHRX	ICEND	CEND	GASC	FID	MF
Type	A	I	I	I	F	F	I	I

VARIABLE**DESCRIPTION**

TMID	Thermal material ID. A unique number or label must be specified (see *PART).
NCHSP	Number of chemical species (maximum 8)
NCHRX	Number of chemical reactions (maximum 8)
ICEND	Species number controlling reaction termination
CEND	Concentration for reaction termination. Reactions are terminated when concentration of species ICEND exceeds CEND.
GASC	Gas constant: 1.987 cal/(mol K), 8.314 J/(mol K)
FID	Function ID for user specified chemical reaction rate equation for a single reaction model with two species
MF	ODE solver method: EQ.0: Default EQ.1: An alternative ODE solver for stiff differential equations

Filler Material Properties. This card is used to the material properties for the filler material, such as carbon fiber mat. This card must be included but all parameters can be set to 0 if no filler material is present.

Card 2	1	2	3	4	5	6	7	8
Variable	RHOf	LCCf	LCKf	VFf				
Type	F	I	I	F				

VARIABLE	DESCRIPTION
RHO _f	Density of the filler material
LCC _f	Load curve ID specifying the specific heat as a function of temperature for the filler material
LCK _f	Load curve ID specifying the thermal conductivity as a function of temperature for the filler material
VF _f	Volume fraction of the filler material. The remaining volume is occupied by the reacting chemicals.

Chemical Species Cards. Include one card for each of the NCHSP species. These cards set species properties. The dummy index i is the species number and is equal to 1 for the first species card, 2 for the second, and so on.

Card 3	1	2	3	4	5	6	7	8
Variable	RHO _{i}	LCC _{i}	LCK _{i}	VF _{i}	MW _{i}			
Type	F	I	I	F	F			

Reaction Cards. Include one card for each of the NCHSP species. Each field contains the species's coefficient for one of the NCHRX chemical reactions. See Card 3 for explanation of the species index i .

Card 4	1	2	3	4	5	6	7	8
Variable	RC _{i/1}	RC _{i/2}	RC _{i/3}	RC _{i/4}	RC _{i/5}	RC _{i/6}	RC _{i/7}	RC _{i/8}
Type	F	F	F	F	F	F	F	F

Reaction Rate Exponent Cards. Include one card for each of the NCHSP species. Each field contains the specie's rate exponent for one of the NCHRX chemical reactions. See Card 3 for explanation of the species index i .

Card 5	1	2	3	4	5	6	7	8
Variable	RX _{i/1}	RX _{i/2}	RX _{i/3}	RX _{i/4}	RX _{i/5}	RX _{i/6}	RX _{i/7}	RX _{i/8}
Type	F	F	F	F	F	F	F	F

VARIABLE	DESCRIPTION
RHO i	Density of the i^{th} species
LCC i	Load curve ID specifying the specific heat as a function of temperature for the i^{th} species
LCK i	Load curve ID specifying the thermal conductivity as a function of temperature for the i^{th} species
VF i	Initial fraction of the i^{th} species relative to the other reacting chemicals. Note that $\sum_i \text{VF}_i = 1$.
MW i	Molecular weight of the i^{th} species
RC ij	Reaction coefficient n_{ij} for species i in reaction j . Leave blank for undefined reactions
RX ij	Rate exponent p_{ij} for species i in reaction j . Leave blank for undefined reactions.

Pre-exponential Factor Card. Each field contains the natural logarithm of its corresponding reaction's pre-exponential factor.

Card 6	1	2	3	4	5	6	7	8
Variable	LCZ1	LCZ2	LCZ3	LCZ4	LCZ5	LCZ6	LCZ7	LCZ8
Type	I	I	I	I	I	I	I	I

VARIABLE	DESCRIPTION
LCZ j	Load curve defining data pairs of (temperature, $\ln Z_j$) where Z_j is the pre-exponential factor for reaction j . Leave blank for undefined reactions.

Activation Energy Card. Each field contains the activation energy value for its corresponding reaction.

Card 7	1	2	3	4	5	6	7	8
Variable	E1	E2	E3	E4	E5	E6	E7	E8
Type	F	F	F	F	F	F	F	F

VARIABLE**DESCRIPTION**

E_j Activation energy for reaction j . Leave blank for undefined reactions.

Heat of Reaction Card. Each field contains the heat of reaction value for its corresponding reaction.

Card 8	1	2	3	4	5	6	7	8
Variable	Q1	Q2	Q3	Q4	Q5	Q6	Q7	Q8
Type	F	F	F	F	F	F	F	F

VARIABLE**DESCRIPTION**

Q_j Heat of reaction for reaction j . Leave blank for undefined reactions.

Rate Model for a Single Reaction:

Chemical reactions are usually expressed in *chemical equation notation*; for example, a chemical reaction involving two reactants and two products is



where A, B, G, and H are chemical species such as NaOH or HCl, and a , b , g , and h are integers called *stoichiometric numbers*, indicating the number of molecules involved in a single reaction.

The rate of reaction is the number of individual reactions per unit time. Using a stoichiometric identity, which is just an accounting relation, the rate of reaction is proportional to the rate of change in the concentrations of the species involved in the reaction. For the chemical reaction in [Equation \(MT6.1\)](#), the relation between concentration and rate, r , is,

$$r = -\frac{1}{a} \frac{d[A]}{dt} = -\frac{1}{b} \frac{d[B]}{dt} = +\frac{1}{g} \frac{d[G]}{dt} = +\frac{1}{h} \frac{d[H]}{dt}, \quad (\text{MT6.2})$$

where $[X]$ denotes the concentration of species X , and the sign depends on whether or not the species is an input, in which case the sign is negative, or a product, in which case the sign is positive.

The Model

This thermal material model (T06) is built on the assumption that the reaction rate r_j of reaction j depends on the concentration of the input species according to

$$r_j = k_j(T) \prod_i [X_i]^{p_{ij}},$$

where i ranges over all species, and, for each species, the exponent, p_{ij} , is determined by empirical measurement but may be approximated by the stoichiometric number associated with X_i . The proportionality constant, k_j , is related to the cross-section for the reaction, and it depends on temperature through the Arrhenius equation:

$$k_j = Z_j(T) \exp\left(-\frac{E_j}{RT}\right),$$

where $Z_j(T)$ is experimentally determined (see Card 6), E_j is the activation energy (see Card 7), R is the gas constant, and T is temperature.

As an example, for the chemical reaction of [Equation \(MT6.1\)](#)

$$r = Z(T) \exp\left(-\frac{E}{RT}\right) [A]^\alpha [B]^\beta,$$

where the stoichiometric numbers have been used instead of experimentally determined exponents.

The rate of heat generation (exothermic) and absorption (endothermic) associated with a reaction is calculated by multiplying the heat of reaction, Q_i , by its rate.

User-Defined Single Reaction Model:

In addition to the standard model described in the previous section this material model also allows the user to specify a chemical reaction rate equation. In case of a single reaction model with two species, the equation can be defined using the `*DEFINE_FUNCTION` keyword. Here, the equation can be given as function of the current temperature and concentration of the second species. Consequently, the input may read as follows:

```
*DEFINE_FUNCTION
1, reaction rate
chemrx(temp, conc) = ...
```

Note that in this case the actual argument names are used for the interpretation of the function: the material model expects the temperature argument to be names "temp" and the concentration of the second species to be denoted by "conc".

Rate Model for a System of Reactions:

For a system of coupled chemical reactions, the change in concentration of a species is the sum of all the contributions from each individual chemical reaction:

$$\frac{d[X_i]}{dt} = \sum_j n_{ij} r_j .$$

The index j runs over all reactions; n_{ij} is the stoichiometric number for species X_i in reaction j ; and r_j is the rate of reaction j . The sign of n_{ij} is positive for reactions that have X_i as a product and negative for reactions that involve X_i as an input.

Example:

Consider the following system of reactions (three reactions and three species):

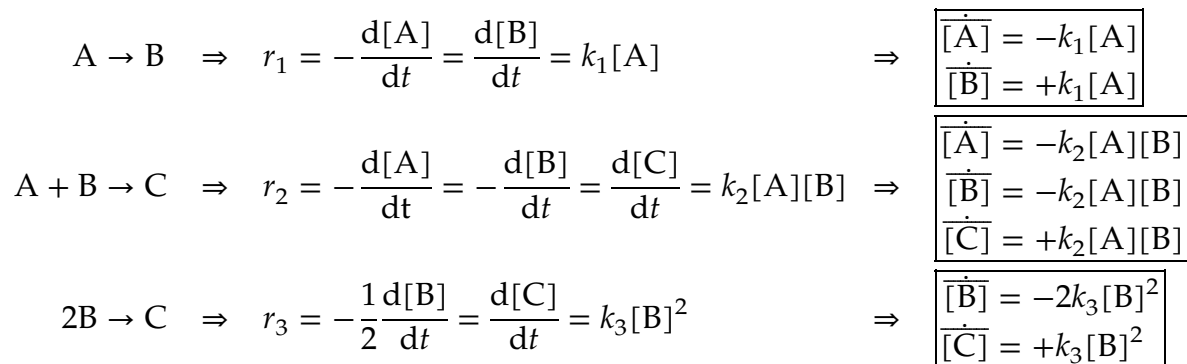

The identities $X_1 = A$, $X_2 = B$, and $X_3 = C$ allow deducing the rate exponents p_{ij} , where both indices i (species) and j (reaction) range from 1 to 3. The nonzero values are

$$\begin{array}{l}
 p_{11} = 1.0 \\
 p_{12} = 1.0 \\
 p_{22} = 1.0 \\
 p_{23} = 2.0
 \end{array} \tag{MT6.3}$$

These values are needed as input parameters RX_{ij} (see card 5 in example input below).

The time evolution equations are,

$$\tag{MT6.4}$$

$$\begin{aligned}\frac{d[B]}{dt} &= \sum n_{2j}r_j = +k_1[A] - k_2[A][B] - 2k_3[B]^2 \\ \frac{d[C]}{dt} &= \sum n_{3j}r_j = \quad \quad \quad + k_2[A][B] + k_3[B]^2.\end{aligned}$$

Equivalent Units (Normalized Units):

The concentrations are often scaled so that each unit of reactant yields one unit of product. Systems for which each species is assigned *its own* unit of concentration based on stoichiometric considerations are *equivalent unit systems*.

Being unit-agnostic, LS-DYNA is capable of working in equivalent units. However, care must be taken so that units are treated consistently, as applying a unit scaling to the time evolution equations can be nontrivial.

1. For each reaction, the experimentally measured pre-exponential coefficients carry units that depend on the reaction itself. For instance, the pre-exponential factors Z_1 , Z_2 , and Z_3 for the reactions $A \rightarrow B$, $A + B \rightarrow C$, and $2B \rightarrow C$ respectively will have units of

$$\begin{aligned}[Z_1] &= \frac{1}{[\text{time}]} \times \frac{1}{[\text{Concentration of A}]} \\ [Z_2] &= \frac{1}{[\text{time}]} \times \frac{1}{[\text{Concentration of A}]} \times \frac{1}{[\text{Concentration of B}]} \\ [Z_3] &= \frac{1}{[\text{time}]} \times \left\{ \frac{1}{[\text{Concentration of B}]} \right\}^2.\end{aligned}$$

Note that each pre-factor has a different dimensionality.

2. The equations in (MT6.2), which relate rate to concentration change, are logically inconsistent unless all species are measured using the *same* units for concentration. A species-dependent system of equivalent units would require the insertion of additional conversion factors into (MT6.2) thereby changing the form of the time-evolution equations.

To avoid unit consistency issues, we recommend that reactions be defined in the same unit system that was used to measure their empirical values.

Example of Equivalent Units:

The following system of reactions:

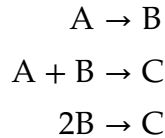

changes species A into species C through an intermediate which is species B. For each unit of species C that is produced, the reaction consumes two units of species A (1 unit from the 1st and 1 unit from the 2nd equation). Since this set of chemical formulae corresponds to the curing of epoxy, which is a nearly volume-preserving process, it is customary to work in a system of equivalent units that correspond to species volume fractions.

The following set of equivalent units, then, is used in the published literature:

1. Whatever the starting concentration of species A is, all units are uniformly rescaled so that $[A] = 1$ at time zero. Per the boxed remark above, since the constants were measured with respect to these units, this consideration does not introduce new complexity.
2. Since the process preserves volume, and since one particle of species C replaces two particles of species A (and one particle of B replace one of A), the units of concentration for species C are doubled.

$$\tilde{C} = 2[C]$$

Under this transformation the rate relation for C is

$$r_2 = r_3 = \frac{d[C]}{dt} = \frac{1}{2} \frac{d\tilde{C}}{dt} .$$

The time evolution [Equations \(MT6.4\)](#) become, (note [C] has been replaced by \tilde{C}):

$$\begin{aligned} \frac{d[A]}{dt} &= \sum n_{1j} r_j &&= -k_1[A] - k_2[A][B] \\ \frac{d[B]}{dt} &= \sum n_{2j} r_j &&= +k_1[A] - k_2[A][B] - 2k_3[B]^2 \\ \frac{d\tilde{C}}{dt} &= 2 \frac{d[C]}{dt} = 2 \sum n_{3j} r_j = \sum \tilde{n}_{3j} r_j &&= +2k_2[A][B] + 2k_3[B]^2 \end{aligned}$$

The coefficients n_{ij} or \tilde{n}_{ij} , respectively, should be identically copied from the above system as reaction coefficients RC_{ij} (for Card 4):

Variable	RC11	RC12	RC13	RC14	RC15	RC16	RC17	RC18
Value	-1	-1	0					

Variable	RC21	RC22	RC23	RC24	RC25	RC26	RC27	RC28
Value	+1	-1	-2					
Variable	RC31	RC32	RC33	RC34	RC35	RC36	RC37	RC38
Value	0	+2	+2					

The exponents RX_{ij} are likewise picked off ([Equations \(MT6.3\)](#)) for next set of cards in format 5:

Variable	RX11	RX12	RX13	RX14	RX15	RX16	RX17	RX18
Value	+1	+1	0					
Variable	RX21	RX22	RX23	RX24	RX25	RX26	RX27	RX28
Value	0	+1	+2					
Variable	RX31	RX32	RX33	RX34	RX35	RX36	RX37	RX38
Value	0	0	0					

*MAT_THERMAL_CWM

This is Thermal Material Type 7. It is a thermal material with temperature dependent properties that allows for material creation triggered by temperature. The acronym CWM stands for Computational Welding Mechanics and the model is intended to be used for simulating multistage weld processes in combination with the mechanical counterpart, *MAT_CWM.

Card 1	1	2	3	4	5	6	7	8
Variable	TMID	TRO	TGRLC	TGMULT	HDEAD	TDEAD	TLAT	HLAT
Type	A	F	F	F	F	F	F	F

Card 2	1	2	3	4	5	6	7	8
Variable	LCHC	LCTC	TLSTART	TLEND	TISTART	TIEND	HGHOST	TGHOST
Type	F	F	F	F	F	F	F	F

VARIABLE

DESCRIPTION

TMID	Thermal material identification. A unique number or label must be specified (see *PART).
TRO	Thermal density: EQ.0.0: Default to structural density
TGRLC	Thermal generation rate (see *DEFINE_CURVE): GT.0: Load curve ID defining thermal generation rate as a function of time EQ.0: Thermal generation rate is the constant multiplier, TGMULT. LT.0: TGRLC is a load curve ID defining thermal generation rate as a function of temperature. This feature is similar to the volumetric heat generation rate in *LOAD_HEAT_GENERATION and has units W/m ³ in the SI units system.

VARIABLE	DESCRIPTION
TGMULT	Thermal generation rate multiplier: EQ.0.0: No heat generation
HDEAD	Specific heat for inactive material before birth time
TDEAD	Thermal conductivity for inactive material before birth time
TLAT	Phase change temperature
HLAT	Latent heat
LCHC	Load curve (or table) for specific heat as function of temperature (and maximum temperature up to current time)
LCTC	Load curve for thermal conductivity as function of temperature
TLSTART	Birth temperature of material start
TLEND	Birth temperature of material end
TISTART	Birth time start
TIEND	Birth time end
HGHOST	Specific heat for ghost (quiet) material
TGHOST	Thermal conductivity for ghost (quiet) material

Remarks:

This material is initially in a quiet state, sometimes referred to as a *ghost material*. In this state the material has the thermal properties defined by the quiet specific heat (HGHOST) and quiet thermal conductivity (TGHOST). These should represent the void, for example, by picking a relatively small thermal conductivity.

However, the ghost specific heat must be chosen with care since the temperature must be allowed to increase at a reasonable rate due to the heat from the weld source. When the temperature reaches the birth temperature, a history variable representing the indicator of the welding material is incremented. This variable follows

$$\gamma(t) = \min \left[1, \max \left(0, \frac{T_{\max} - T_l^{\text{start}}}{T_l^{\text{end}} - T_l^{\text{start}}} \right) \right],$$

where $T_{\max} = \max\{T(s) | s < t\}$.

The effective thermal material properties are interpolated as

$$\begin{aligned}\tilde{c}_p &= c_p(T, T_{\max})\gamma + c_p^{\text{quiet}}(1 - \gamma) \\ \tilde{\mu} &= \mu(T)\gamma + \mu^{\text{quiet}}(1 - \gamma)\end{aligned}$$

where c_p and μ are the specific heat and thermal conductivity, respectively. Here, the specific heat, c_p , is either a temperature dependent curve, or a collection of temperature dependent curves, ordered in a table according to maximum temperature T_{\max} .

The time parameters for creating the material provide additional formulae for the final values of the thermal properties. Before the birth time t_i^{start} of the material has been reached, the specific heat c_p^{dead} and thermal conductivity μ^{dead} are used. The default values, that is, the values used if no user input is given, are

$$\begin{aligned}c_p^{\text{dead}} &= 10^{10}c_p(T, T_{\max}) \\ \mu^{\text{dead}} &= 0\end{aligned}$$

Thus, the final values of the thermal properties read

$$c_p = \begin{cases} c_p^{\text{dead}} & t \leq t_i^{\text{start}} \\ \tilde{c}_p \frac{t - t_i^{\text{start}}}{t_i^{\text{end}} - t_i^{\text{start}}} + c_p^{\text{dead}} \frac{t - t_i^{\text{end}}}{t_i^{\text{start}} - t_i^{\text{end}}} & t_i^{\text{start}} < t \leq t_i^{\text{end}} \\ \tilde{c}_p & t_i^{\text{end}} < t \end{cases}$$

$$\mu = \begin{cases} \mu^{\text{dead}} & t \leq t_i^{\text{start}} \\ \tilde{\mu} \frac{t - t_i^{\text{start}}}{t_i^{\text{end}} - t_i^{\text{start}}} + \mu^{\text{dead}} \frac{t - t_i^{\text{end}}}{t_i^{\text{start}} - t_i^{\text{end}}} & t_i^{\text{start}} < t \leq t_i^{\text{end}} \\ \tilde{\mu} & t_i^{\text{end}} < t \end{cases}$$

These parameters allow you to control when the welding layer becomes active and thereby define a multistage welding process. Prior to the birth time, the temperature is kept more or less constant due to the large specific heat, and, thus, the material is prevented from being created

***MAT_THERMAL_ORTHOTROPIC_TD_LC**

This is Thermal Material Type 8. With this model, orthotropic thermal properties that are dependent on temperature (and/or mechanical history variables) can be specified with load curves. The properties must be defined for the temperature (and/or history variable) range that the material will see in the analysis.

Card Summary:

Card 1a. This card is included if ITGHSV = 0 (see Card 2).

TMID	TRO	TGRLC	TGMULT	AOPT	TLAT	HLAT	
------	-----	-------	--------	------	------	------	--

Card 1b. This card is included if |ITGHSV| > 0 (see Card 2).

TMID	TRO	TGRLC	TGMULT	AOPT	TLAT	HLAT	
------	-----	-------	--------	------	------	------	--

Card 2. This card is required.

LCC	LCK1	LCK2	LCK3	ILCCHSV	ILCKHSV	ITGHSV	
-----	------	------	------	---------	---------	--------	--

Card 3. This card is required.

XP	YP	ZP	A1	A2	A3		
----	----	----	----	----	----	--	--

Card 4. This card is required.

D1	D2	D3					
----	----	----	--	--	--	--	--

Data Card Definitions:

This card is included if ITGHSV = 0 (see Card 2).

Card 1a	1	2	3	4	5	6	7	8
Variable	TMID	TRO	TGRLC	TGMULT	AOPT	TLAT	HLAT	
Type	A	F	I	F	F	F	F	

VARIABLE

DESCRIPTION

TMID

Thermal material identification. A unique number or label must be specified (see *PART).

VARIABLE	DESCRIPTION
TRO	Thermal density. EQ.0.0: Default to structural density
TGRLC	Thermal generation rate (see *DEFINE_CURVE). See Remark 1 . GT.0: Load curve ID defining thermal generation rate as a function of time EQ.0: Thermal generation rate is the constant multiplier, TGMULT. LT.0: TGRLC is a load curve ID defining thermal generation rate as a function of temperature.
TGMULT	Thermal generation rate multiplier. EQ.0.0: No heat generation
AOPT	Material axes definition (see *MAT_OPTIONTROPIC_ELASTIC for a more complete description): EQ.0.0: Locally orthotropic with material axes by element nodes N1, N2 and N4 EQ.1.0: Locally orthotropic with material axes determined by a point in space and global location of element center EQ.2.0: Globally orthotropic with material axes determined by vectors EQ.3.0: Locally orthotropic with first material axis orthogonal to element normal (defined by element nodes N1, N2 and N4) and to a vector \mathbf{d} - Third material direction corresponds to element normal. EQ.4.0: Local orthogonal in cylindrical coordinates with the material axes determined by a vector \mathbf{d} , and an originating point, P , which define the centerline axis
TLAT	Phase change temperature
HLAT	Latent heat

This card is included if $|ITGHSV| > 0$ (see Card 2).

Card 1b	1	2	3	4	5	6	7	8
Variable	TMID	TRO	TGRLC	TGMULT	AOPT	TLAT	HLAT	
Type	A	F	I	F	F	F	F	

VARIABLE**DESCRIPTION**

TMID	Thermal material identification. A unique number or label must be specified (see *PART).
TRO	Thermal density. EQ.0.0: Default to structural density
TGRLC	Thermal generation rate curve/table ID (see *DEFINE_CURVE). See Remark 1 . GT.0: Load curve giving thermal generation rate as a function of the mechanical history variable specified by ITGHSV. EQ.0: Use mechanical history variable specified by ITGHSV times constant multiplier value TGMULT. LT.0: Table of load curves for different temperatures. Each curve gives the thermal generation rate as a function of the mechanical history variable specified by ITGHSV.
TGMULT	Thermal generation rate multiplier. Defines a volumetric heat rate (W/m^3 in SI units system). EQ.0.0: No heat generation
AOPT	Material axes definition (see *MAT_OPTIONTROPIC_ELASTIC for a more complete description): EQ.0.0: Locally orthotropic with material axes by element nodes N1, N2 and N4 EQ.1.0: Locally orthotropic with material axes determined by a point in space and global location of element center EQ.2.0: Globally orthotropic with material axes determined by vectors

VARIABLE	DESCRIPTION
	EQ.3.0: Locally orthotropic with first material axis orthogonal to element normal (defined by element nodes N1, N2 and N4) and to a vector d - Third material direction corresponds to element normal.
	EQ.4.0: Local orthogonal in cylindrical coordinates with the material axes determined by a vector d , and an originating point, <i>P</i> , which define the centerline axis.
TLAT	Phase change temperature
HLAT	Latent heat

Card 2	1	2	3	4	5	6	7	8
Variable	LCC	LCK1	LCK2	LCK3	ILCCHSV	ILCKHSV	ITGHSV	
Type	I	I	I	I	I	I	I	

VARIABLE	DESCRIPTION
LCC	<p>Load curve ID defining specific heat as a function of temperature, or if ILCCHSV > 0:</p> <p>GT.0: Load curve as function of mechanical history variable specified by ILCCHSV.</p> <p>LT.0: Table of load curves for different temperatures. Each curve is a function of the mechanical history variable specified by ILCCHSV.</p>
LCK _{<i>i</i>}	<p>Load curve ID defining thermal conductivity, K_i ($i = 1,2,3$), in the local (x,y,z)-direction as a function of temperature, or if ILCKHSV > 0:</p> <p>GT.0: Load curve giving thermal conductivity in the local direction as a function of the mechanical history variable specified by ILCKHSV.</p> <p>LT.0: Table of load curves for different temperatures. Each curve gives thermal conductivity in the local direction as a function of the mechanical history variable specified by ILCKHSV.</p>

VARIABLE	DESCRIPTION
----------	-------------

ILCCHSV	<p>Optional:</p> <p>GT.0: Mechanical history variable # used by LCC.</p> <p>LT.0: As above but $ILCCHSV = 1$ through 6 means the history variable is one of the six stress components, $ILCCHSV = 7$ means the history variable is the plastic strain, and $ILCCHSV = 7 + k$ means the history variable is history variable k.</p>
---------	--

ILCKHSV	<p>Optional:</p> <p>GT.0: Mechanical history variable # used by LCK1, LCK2, LCK3.</p> <p>LT.0: As above but $ILCKHSV = 1$ through 6 means the history variable is one of the six stress components, $ILCKHSV = 7$ means the history variable is the plastic strain, and $ILCKHSV = 7 + k$ means the history variable is history variable k.</p>
---------	---

ITGHSV	<p>Optional:</p> <p>GT.0: Mechanical history variable # used by TGRLC.</p> <p>LT.0: As above but $ITGHSV = 1$ through 6 means the history variable is one of the six stress components, $ITGHSV = 7$ means the history variable is the plastic strain, and $ITGHSV = 7 + k$ means the history variable is history variable k.</p>
--------	---

Card 3	1	2	3	4	5	6	7	8
Variable	XP	YP	ZP	A1	A2	A3		
Type	F	F	F	F	F	F		

Card 4	1	2	3	4	5	6	7	8
Variable	D1	D2	D3					
Type	F	F	F					

VARIABLE	DESCRIPTION
XP, YP, ZP	Coordinates of point p for AOPT = 1 and 4
A1, A2, A3	Components of vector \mathbf{a} for AOPT = 2
D1, D2, D3	Components of vector \mathbf{d} for AOPT = 2, 3 and 4

Remarks:

1. **Thermal Generation Rate.** TGRLC is similar to the volumetric heat generation rate in *LOAD_HEAT_GENERATION and has units W/m^3 in the SI units system

***MAT_THERMAL_ISOTROPIC_PHASE_CHANGE**

This is Thermal Material Type 9. With this material, temperature dependent isotropic properties with phase change can be defined. The latent heat of the material is defined together with the solid and liquid temperatures. The temperature dependency is defined by specifying a minimum of two and a maximum of eight data points. The properties must be defined for the temperature range that the material will see in the analysis.

Card 1	1	2	3	4	5	6	7	8
Variable	TMID	TR0	TGRLC	TGMULT				
Type	A	F	F	F				

Card 2	1	2	3	4	5	6	7	8
Variable	T1	T2	T3	T4	T5	T6	T7	T8
Type	F	F	F	F	F	F	F	F

Card 3	1	2	3	4	5	6	7	8
Variable	C1	C2	C3	C4	C5	C6	C7	C8
Type	F	F	F	F	F	F	F	F

Card 4	1	2	3	4	5	6	7	8
Variable	K1	K2	K3	K4	K5	K6	K7	K8
Type	F	F	F	F	F	F	F	F

Card 5	1	2	3	4	5	6	7	8
Variable	SOLT	LIQT	LH					
Type	F	F	F					

VARIABLE**DESCRIPTION**

TMID	Thermal material identification. A unique number or label must be specified (see *PART).
TRO	Thermal density: EQ.0.0: Default to structural density
TGRLC	Thermal generation rate (see *DEFINE_CURVE). See Remark 2 . GT.0: Load curve ID defining thermal generation rate as a function of time EQ.0: Thermal generation rate is the constant multiplier, TGMULT. LT.0: TGRLC is a load curve ID defining thermal generation rate as a function of temperature.
TGMULT	Thermal generation rate multiplier: EQ.0.0: No heat generation
T1, ..., T8	Temperatures: T1, ..., T8
C1, ..., C8	Specific heat at T1, ..., T8
K1, ..., K8	Thermal conductivity at T1, ..., T8
SOLT	Solid temperature, T_S (must be $< T_L$)
LIQT	Liquid temperature, T_L (must be $> T_S$)
LH	Latent heat

Remarks:

1. **Phase Change.** During phase change, meaning between the solid and liquid temperatures, the specific heat of the material will be enhanced to account for the latent heat as follows:

$$c(t) = m \left[1 - \cos 2\pi \left(\frac{T - T_S}{T_L - T_S} \right) \right], \quad T_S < T < T_L$$

Here m is a multiplier such that the latent heat λ is given by:

$$\lambda = \int_{T_S}^{T_L} c(T) dT .$$

Here $c(T)$ is the specific heat.

2. **Thermal Generation Rate.** TGRLC is similar to the volumetric heat generation rate in *LOAD_HEAT_GENERATION and has units W/m³ in the SI units system.

***MAT_THERMAL_ISOTROPIC_TD_LC**

This is Thermal Material Type 10. With this model, isotropic thermal properties that are dependent on temperature (and/or mechanical history variables) can be specified with load curves. The properties must be defined for the temperature (and/or history variable) range that the material will see in the analysis.

Card Summary:

Card 1a. This card is included if TGHSV = 0.

TMID	TRO	TGRLC	TGMULT	TLAT	HLAT		
------	-----	-------	--------	------	------	--	--

Card 1b. This card is included if TGHSV ≠ 0.

TMID	TRO	TGRLC	TGMULT	TLAT	HLAT		
------	-----	-------	--------	------	------	--	--

Card 2. This card is required.

HCLC	TCLC	HCHSV	TCHSV	TGHSV			
------	------	-------	-------	-------	--	--	--

Data Card Definitions:

This card is included if TGHSV = 0 (see Card 2).

Card 1a	1	2	3	4	5	6	7	8
Variable	TMID	TRO	TGRLC	TGMULT	TLAT	HLAT		
Type	A	F	I	F	F	F		

VARIABLE**DESCRIPTION**

TMID	Thermal material identification. A unique number or label must be specified (see *PART).
TRO	Thermal density. EQ.0.0: Default to structural density
TGRLC	Thermal generation rate (see *DEFINE_CURVE). See Remark 1 . GT.0: Load curve ID defining thermal generation rate as a function of time

VARIABLE	DESCRIPTION
	EQ.0: Thermal generation rate is the constant multiplier, TGMULT. LT.0: TGRLC is a load curve ID defining thermal generation rate as a function of temperature.
TGMULT	Thermal generation rate multiplier. EQ.0.0: No heat generation
TLAT	Phase change temperature
HLAT	Latent heat

This card is included if |TGHSV| > 0 (see Card 2).

Card 1b	1	2	3	4	5	6	7	8
Variable	TMID	TRO	TGRLC	TGMULT	TLAT	HLAT		
Type	A	F	I	F	F	F		

VARIABLE	DESCRIPTION
TMID	Thermal material identification. A unique number or label must be specified (see *PART).
TRO	Thermal density. EQ.0.0: Default to structural density
TGRLC	Thermal generation rate curve/table ID (see *DEFINE_CURVE). See Remark 1 . GT.0: Load curve specifying thermal generation rate as a function of the mechanical history variable specified by TGHSV. EQ.0: Use mechanical history variable specified by ITGHSV times constant multiplier value TGMULT. LT.0: Table of load curves for different temperatures. Each curve specifies the thermal generation rate as a function of the mechanical history variable specified by TGHSV.

VARIABLE	DESCRIPTION
TGMULT	Thermal generation rate multiplier. Defines a volumetric heat rate (W/m ³ in SI units system). EQ.0.0: No heat generation
TLAT	Phase change temperature
HLAT	Latent heat

Card 2	1	2	3	4	5	6	7	8
Variable	HCLC	TCLC	HCHSV	TCHSV	TGHSV			
Type	I	I	I	I	I			

VARIABLE	DESCRIPTION
HCLC	Load curve ID specifying specific heat as a function of temperature, or, if HCHSV > 0: GT.0: Load curve specifying the specific heat as a function of the mechanical history variable specified by HCHSV. LT.0: Table of load curves for different temperatures. Each curve specifies the specific heat as a function of the mechanical history variable specified by HCHSV.
TCLC	Load curve ID specifying thermal conductivity as a function of temperature, or if TCHSV > 0: GT.0: Load curve giving thermal conductivity as a function of the mechanical history variable specified by TCHSV. LT.0: Table of load curves for different temperatures. Each curve is a function of the mechanical history variable specified by TCHSV.
HCHSV	Optional: GT.0: Mechanical history variable # used by HCLC.

VARIABLE**DESCRIPTION**

	LT.0: As above but $ HCHSV = 1$ through 6 means that the variable is one of the six stress components, $ HCHSV = 7$ means that the variable is the plastic strain, and $ HCHSV = 7 + k$ means that the variable is history variable k .
TCHSV	Optional: GT.0: Mechanical history variable # used by TCLC. LT.0: As above but $ TCHSV = 1$ through 6 means the variable is one of the six stress components, $ TCHSV = 7$ means the variable is the plastic strain, and $ TCHSV = 7 + k$ means that the variable is history variable k .
TGHSV	Optional: GT.0: Mechanical history variable # used by TGRLC. LT.0: As above but $ TGHSV = 1$ through 6 means the variable is one of the six stress components, $ TGHSV = 7$ means the variable is the plastic strain, and $ TGHSV = 7 + k$ means that the variable is history variable k .

Remarks:

1. **Thermal Generation Rate.** TGRLC is similar to the volumetric heat generation rate in *LOAD_HEAT_GENERATION. It has units W/m^3 in the SI units system.

*MAT_THERMAL_USER_DEFINED

These are Thermal Material Types 11 - 15. You can supply your own subroutines. Please consult Appendix H for more information.

Card Summary:

Card 1. This card is required.

TMID	RO	MT	LMC	NVH	AOPT	IORTHO	IHVE
------	----	----	-----	-----	------	--------	------

Card 1.1. This card is included if IORTHO = 1.

XP	YP	ZP	A1	A2	A3		
----	----	----	----	----	----	--	--

Card 1.2. This card is included if IORTHO = 1.

D1	D2	D3					
----	----	----	--	--	--	--	--

Card 2. Up to 4 of this card can be included to set LMC parameters. This input ends at the next keyword ("*") card.

P1	P2	P3	P4	P5	P6	P7	P8
----	----	----	----	----	----	----	----

Data Card Definitions:

Card 1	1	2	3	4	5	6	7	8
Variable	TMID	RO	MT	LMC	NVH	AOPT	IORTHO	IHVE
Type	A	F	F	F	F	F	F	F

VARIABLE

DESCRIPTION

TMID	Thermal material identification. A unique number or label must be specified (see *PART).
RO	Thermal mass density
MT	User material type (11-15 inclusive)
LMC	Length of material constants array. LMC must not be greater than 32.

VARIABLE	DESCRIPTION
NVH	Number of history variables
AOPT	Material axes option of orthotropic materials (see MAT_OPTION-TROPIC_ELASTIC for more details). Set if IORTHO = 1.0. EQ.0.0: Locally orthotropic with material axes by element nodes N1, N2 and N4 EQ.1.0: Locally orthotropic with material axes determined by a point, P , in space and global location of element center EQ.2.0: Globally orthotropic with material axes determined by vectors EQ.3.0: Locally orthotropic with first material axis orthogonal to element normal (defined by element nodes N1, N2 and N4) and to a vector \mathbf{d} - Third material direction corresponds to element normal. EQ.4.0: Local orthogonal in cylindrical coordinates with the material axes determined by a vector \mathbf{d} , and an originating point, P , which define the centerline axis. LT.0.0: The absolute value of AOPT is a coordinate system ID number (CID on *DEFINE_COORDINATE_NODES, *DEFINE_COORDINATE_SYSTEM or *DEFINE_COORDINATE_VECTOR).
IORTHO	Set to 1.0 if the material is orthotropic.
IHVE	Set to 1.0 to activate exchange of history variables between mechanical and thermal user material models.

Orthotropic Card 1. Additional card read in when IORTHO = 1.

Card 1.1	1	2	3	4	5	6	7	8
Variable	XP	YP	ZP	A1	A2	A3		
Type	F	F	F	F	F	F		

VARIABLE	DESCRIPTION
XP, YP, ZP	Coordinates of point P for AOPT = 1 and 4
A1, A2, A3	Components of vector \mathbf{a} for AOPT = 2

Orthotropic Card 2. Additional card read in when IORTHO = 1.

Card 1.2	1	2	3	4	5	6	7	8
Variable	D1	D2	D3					
Type	F	F	F					

VARIABLE**DESCRIPTION**

D1, D2, D3

Components of vector **d** for AOPT = 2, 3 and 4

Material Parameter Cards. Set up to 8 parameters per card. Include up to 4 cards. This input ends at the next keyword ("*") card.

Card 2	1	2	3	4	5	6	7	8
Variable	P1	P2	P3	P4	P5	P6	P7	P8
Type	F	F	F	F	F	F	F	F

VARIABLE**DESCRIPTION**

P1

First material parameter

⋮

⋮

PLMC

LMCth material parameter**Remarks:**

1. **IHVE.** The IHVE = 1 option makes it possible for a thermal user material subroutine to read the history variables of a mechanical user material subroutine defined for the same part and vice versa. If the integration points for the thermal and mechanical elements are not coincident, then extrapolation/interpolation is used to calculate the value when reading history variables.
2. **TITLE.** Option TITLE is supported
3. **Units Transformation.** Transformation of units using *INCLUDE_TRANSFORM is only supported for the RO field and the vectors on Cards 1.1 and 1.2.

***MAT_THERMAL_CHEMICAL_REACTION_ORTHOTROPIC**

This is Thermal Material Type 17. The chemical species making up this material undergo specified chemical reactions. The chemical reaction kinetics is the same as for thermal material *MAT_T06, but the thermal conductivity is assumed to be orthotropic. A maximum of 8 species and 8 chemical reactions can be defined. The orthotropic thermal material properties of a finite element undergoing chemical reactions are calculated based on a mixture law consisting of those chemical species currently present in the element. The dependence of the chemical reaction rate on temperature is described by the Arrhenius equation. Time step splitting is used to couple the system of ordinary differential equations describing the chemical reaction kinetics to the system of partial differential equations describing the diffusion of heat.

Card Summary:

Card 1. This card is required.

TMID	NCHSP	NCHRX	ICEND	CEND	GASC	FID	MF
------	-------	-------	-------	------	------	-----	----

Card 2. This card is required.

AOPT	XP	YP	ZP	A1	A2	A3	
------	----	----	----	----	----	----	--

Card 3. This card is required.

D1	D2	D3					
----	----	----	--	--	--	--	--

Card 4. This card must be included, but all parameters can be set to 0 if no filler material is present.

RHOf	LCCf	LCK1f	LCK2f	LCK3f	VFf		
------	------	-------	-------	-------	-----	--	--

Card 5. Include one card for each of the NCHSP species.

RHOf	LCCf	LCK1f	LCK2f	LCK3f	VFf	MWf	
------	------	-------	-------	-------	-----	-----	--

Card 6. Include one card for each of the NCHSP species.

RC/1	RC/2	RC/3	RC/4	RC/5	RC/6	RC/7	RC/8
------	------	------	------	------	------	------	------

Card 7. Include one card for each of the NCHSP species.

RX/1	RX/2	RX/3	RX/4	RX/5	RX/6	RX/7	RX/8
------	------	------	------	------	------	------	------

Card 8. This card is required.

LCZ1	LCZ2	LCZ3	LCZ4	LCZ5	LCZ6	LCZ7	LCZ8
------	------	------	------	------	------	------	------

Card 9. This card is required.

E1	E2	E3	E4	E5	E6	E7	E8
----	----	----	----	----	----	----	----

Card 10. This card is required.

Q1	Q2	Q3	Q4	Q5	Q6	Q7	Q8
----	----	----	----	----	----	----	----

Data Card Definitions:

Card 1	1	2	3	4	5	6	7	8
Variable	TMID	NCHSP	NCHRX	ICEND	CEND	GASC	FID	MF
Type	A	I	I	I	F	F	I	I

VARIABLE

DESCRIPTION

TMID	Thermal material identification. A unique number or label must be specified (see *PART).
NCHSP	Number of chemical species (maximum 8)
NCHRX	Number of chemical reactions (maximum 8)
ICEND	Species number controlling reaction termination
CEND	Concentration for reaction termination
GASC	Gas constant: 1.987 cal/(mol K), 8314. J/(mol K)
FID	Function ID for user specified chemical reaction rate equation for a single reaction model with two species
MF	ODE solver method: EQ.0: Default EQ.1: An alternative ODE solver

Material axis definition. This card sets the material axes for the orthotropic heat conduction properties.

Card 2	1	2	3	4	5	6	7	8
Variable	AOPT	XP	YP	ZP	A1	A2	A3	
Type	I	F	F	F	F	F	F	

Card 3	1	2	3	4	5	6	7	8
Variable	D1	D2	D3					
Type	F	F	F					

VARIABLE**DESCRIPTION**

AOPT

Material axes definition (see *MAT_OPTIONTROPIC_ELASTIC for a more complete description):

EQ.0.0: Locally orthotropic with material axes by element nodes N1, N2 and N4

EQ.1.0: Locally orthotropic with material axes determined by a point in space and global location of element center

EQ.2.0: Globally orthotropic with material axes determined by vectors

EQ.3.0: Locally orthotropic with first material axis orthogonal to element normal (defined by element nodes N1, N2 and N4) and to a vector **d**- Third material direction corresponds to element normal.

EQ.4.0: Local orthogonal in cylindrical coordinates with the material axes determined by a vector **d**, and an originating point, *P*, which define the centerline axis.

XP, YP, ZP

Coordinates of point *p* for AOPT = 1 and 4

A1, A2, A3

Components of vector **a** for AOPT = 2

D1, D2, D3

Components of vector **d** for AOPT = 2, 3 and 4

Filler Material Properties. This card sets the material properties for the filler material, such as carbon fiber. This card must be included, but all parameters can be set to 0 if no filler material is present.

Card 4	1	2	3	4	5	6	7	8
Variable	RHOf	LCCf	LCK1f	LCK2f	LCK3f	VFf		
Type	F	I	I	I	I	F		

VARIABLE**DESCRIPTION**

RHOf	Density of the filler material
LCCf	Load curve ID specifying the specific heat as a function of temperature for the filler material
LCK1f	Load curve ID specifying thermal conductivity K_1 , in the local x -direction, as a function of temperature for the filler material
LCK2f	Load curve ID specifying thermal conductivity K_2 , in the local y -direction, as a function of temperature for the filler material
LCK3f	Load curve ID specifying thermal conductivity K_3 , in the local z -direction, as a function of temperature for the filler material
VFf	Volume fraction of the filler material. The remaining volume is occupied by the reacting chemicals.

Chemical Species Cards. Include one card for each of the NCHSP species. These cards set properties for each species. The dummy index i is the species number and is equal to 1 for the first species card, 2 for the second, and so on.

Card 5	1	2	3	4	5	6	7	8
Variable	RHOf	LCCf	LCK1f	LCK2f	LCK3f	VFf	MWf	
Type	F	I	I	I	I	F	F	

Reaction Cards. Include one card for each of the NCHSP species. Each field contains the species' coefficient for one of the NCHRX chemical reactions. See Card 5 for explanation of the species index i .

Card 6	1	2	3	4	5	6	7	8
Variable	RC/1	RC/2	RC/3	RC/4	RC/5	RC/6	RC/7	RC/8
Type	F	F	F	F	F	F	F	F

Reaction Rate Exponent Cards. Include one card for each of the NCHSP species. Each field contains the species' rate exponent for one of the NCHRX chemical reactions. See Card 5 for explanation of the species index i .

Card 7	1	2	3	4	5	6	7	8
Variable	RX/1	RX/2	RX/3	RX/4	RX/5	RX/6	RX/7	RX/8
Type	F	F	F	F	F	F	F	F

VARIABLE**DESCRIPTION**

RHO i	Density of the i^{th} species
LCC i	Load curve ID specifying the specific heat as a function of temperature for the i^{th} species
LCK1 i	Load curve ID specifying thermal conductivity K_1 , in the local x -direction, as a function of temperature for the i^{th} species
LCK2 i	Load curve ID specifying thermal conductivity K_2 , in the local y -direction, as a function of temperature for the i^{th} species
LCK3 i	Load curve ID specifying thermal conductivity K_3 , in the local z -direction, as a function of temperature for the i^{th} species
VF i	Initial fraction of the i^{th} species relative to the other reacting chemicals. Note that $\sum_i \text{VF}_i = 1$.
MW i	Molecular weight of the i^{th} species
RC ij	Reaction coefficient for species i in reaction j . Leave blank for undefined reactions.

VARIABLE**DESCRIPTION** RX_{ij}

Rate exponent for species i in reaction j . Leave blank for undefined reactions.

Pre-exponential Factor Card. Each field contains the natural logarithm of its corresponding reaction's pre-exponential factor.

Card 8	1	2	3	4	5	6	7	8
Variable	LCZ1	LCZ2	LCZ3	LCZ4	LCZ5	LCZ6	LCZ7	LCZ8
Type	I	I	I	I	I	I	I	I

VARIABLE**DESCRIPTION** LCZ_j

Load curve defining data pairs of (temperature, $\ln Z_j$) where Z_j is the pre-exponential factor for reaction j . Leave blank for undefined reactions.

Activation Energy Card. Each field contains the activation energy value for its corresponding reaction.

Card 9	1	2	3	4	5	6	7	8
Variable	E1	E2	E3	E4	E5	E6	E7	E8
Type	F	F	F	F	F	F	F	F

VARIABLE**DESCRIPTION** E_j

Activation energy for reaction j . Leave blank for undefined reactions.

Heat of Reaction Card. Each field contains the heat of reaction value for its corresponding reaction.

Card 10	1	2	3	4	5	6	7	8
Variable	Q1	Q2	Q3	Q4	Q5	Q6	Q7	Q8
Type	F	F	F	F	F	F	F	F

VARIABLE**DESCRIPTION**

 Q_j Heat of reaction for reaction j . Leave blank for undefined reactions.**Remarks:**

See the remarks for *MAT_T06.

